

MEGAMAN
Eléctrica S. A.

Light Solutions









Catálogo - Tarifa 2018/19

ÍNDICE MARCAS

MEGAMAN ELÉCTRICA



ÍNDICE MARCAS

 <p>Pag 15 a 139</p>	 <p>Pag 141 a 147</p>	 <p>Pag 149 a 165</p>	 <p>Pag 167 a 185</p>
 <p>Pag 187 a 200</p>	 <p>Pag 203 a 217</p>	 <p>Pag 219 a 261</p>	 <p>Pag 263 a 265</p>
 <p>Lumotech</p> <p>Pag 267 a 273</p>			

NOMENCLATURAS E ICONOS

NOMENCLATURAS

ICONO	DEFINICIÓN
COD.	Código de producto.
REF. INT	Referencia internacional de la fábrica.
W	Vatios.
TC	Temperatura de color.
Lm	Lúmenes.
CRI	Índice Cromático.
IP	Índice de protección.

ICONOS DE USOS ESPECIALES



Especial carnes o embutidos.



Especial panaderías.



Especial frutas o verduras.



Especial pescaderías.



Especial plantas.



ÚLTIMAS UNIDADES

ICONOS MEGAMAN



PROFESIONAL SERIES



ECONOMY SERIES



SMART SERIES



BASIC SERIES



DIM TO WARM

Atenuación de la TC de 2700K a 1800K.



INGENIUM SMART LIGHTING

Control de la iluminación por bluetooth.



DBT

Dual Beam Technology, cambia el haz de luz pulsando la lente.



U-DIM (either leading or trailing edge)

Compatible con una amplia gama de reguladores de luz.



Hybrid Reflector

Reflector multidireccional.



HIGH LUMEN

Alta salida de lúmenes.



PERFECT WHITE

Iluminación para realzar el color Blanco.



FILAMENTO LARGO

Filamentos de led largos.



GARANTÍA*

Consultar condiciones de garantía.

ICONOS TÉCNICOS



DIMABLE

Producto regulable.



ÁNGULO

Haz de luz de la lámpara.



CASQUILLO

Tipo de portalámparas.



HORAS DE VIDA



DIÁMETRO

Medida del diámetro.



MEDIDAS



CORTE

Medida de corte de la luminaria.



PESO



ROTACIÓN

Ángulo de rotación de la luminaria.



INCLINACIÓN

Ángulo de inclinación de la luminaria.

NEW



ROLL UP 205x85

Megaman Lámparas - Vintage Series - Megaman Luminarias - Lightbeer - Soraa



Expositor Megaman
590x380x1773 mm

NEW



Expositor de mesa



Tapete para sobremesa



Expositor Dim to WARM
No incluye lámpara - Pag 106



Expositor Bluetooth
No incluye lámpara - Pag 107



ÍNDICE GENERAL

MEGAMAN ELÉCTRICA

LUMINARIAS LED

EMPOTRAR FIJO



Siena 20
Megaman

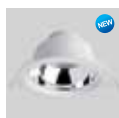

Siena SR 22
Megaman



Rico 24
Megaman



Genoa 26
Megaman



Conxento 27
Megaman



Envy 28
Megaman



Elux R 152
PeroxLighting



Elux SR 154
PeroxLighting



Mitec 157
PeroxLighting



Nexio 158
PeroxLighting



Hylux 159
PeroxLighting



ARC Cuadrado 178
Soraa



ARC Redondo 178
Soraa



Downlight 223
Redondo
MMelectric



Downlight 224
Cuadrado
MMelectric



Estela 30
Panel 1
Megaman



Estela 31
Panel 2
Megaman



Berto 32
UGR19
Megaman



Tile 225
MMelectric



Barrel 171
Soraa



Gable 170
Soraa

EMPOTRAR ORIENTABLE



Siena Mini 44
Megaman



Vito 36
Megaman



Carlo 37
Megaman



Rico Hr 40
Megaman



Zeki 38
AR111
Megaman



Titlux 163
PeroxLighting



Zeki 50 39
Megaman

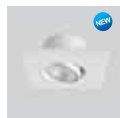

Anna 41
Megaman



Abby 42
Megaman



Foco 43
Megaman



Axtos 68 160
PeroxLighting



Garlux 161
PeroxLighting



Kara 47
Megaman



Shoplighter 226
MMelectric

SUPERFICIE



Conxento 50
Megaman



Canolux 165
PeroxLighting



Downlight 227
Redondo
MMelectric



Downlight 227
Cuadrado
MMelectric

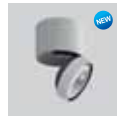

ARA 176
Soraa



Keto 53
Megaman



Pino 52
Megaman



Delta T2 51
Megaman



Sunlit T5 274
MMelectric



Sunlit T8 274
MMelectric



Ultra Slim 274
MMelectric



Mx T5 274
MMelectric



Tiras Led 228
MMelectric

CARRIL



Marco Mini 56
Megaman



Marco Midi 57
Megaman



Marco 58
Megaman



Modena 59
Megaman



Alda 60
Megaman



Toby 61
Megaman



Corruna 62
Megaman



Mosaic 64
Megaman



Mora 65
Megaman



Ricco 229
MMelectric

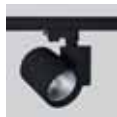

Decco 230
MMelectric



Loft 63
Megaman



ART 172
Soraa



Carriles 205
Trifásicos
Unipro



Carriles 205
Empotrar
Unipro



Conectores 206
Trifásicos
Unipro



Carriles 208
DALI
Unipro



Conectores 210
DALI
Unipro

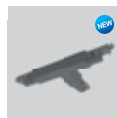

Accesorios 212
Carriles
Unipro

ÍNDICE GENERAL

MEGAMAN ELÉCTRICA

LUMINARIAS LED

SUSPENSIÓN

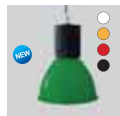

Fresh 232
MMelectric

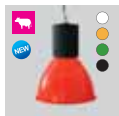

Pink 233
MMelectric



Bay 236
MMelectric



Storm 234
MMelectric



Luster 68
Megaman



Gabio 67
Megaman



Leo 70
Megaman

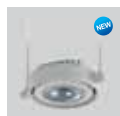

ARP 174
Soraa

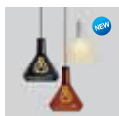

Drop Top 194
Plumen

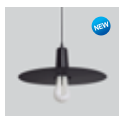

Drop Hat 195
Plumen

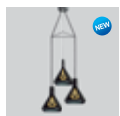

Chandelier 195
Plumen



Drop Pendant 198
Plumen



Modern Family 200
Plumen



Cables Color 246
MMelectric

OUTDOOR



Gorky 142
Megatron

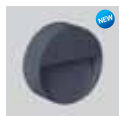

Loka 145
Megatron



Cango 143
Megatron



Número 144
Megatron



Ensio 74
Megaman



Tott 76
Megaman



Tott 77
Economy
Megaman



Cortona 78
Megaman



Ispots 147
Megatron



Keppa 79
Megaman



Advant 80
Megaman



Delta Slim 237
MMelectric



Cappi 79
Megaman



Bulka 146
Megatron



Fonda Redondo 81
Megaman

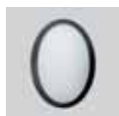

Fonda Oval 81
Megaman



Dino 1 82
Megaman



Dino 2 83
Megaman



Dino Farm 84
Megaman



Mezo 85
Megaman

LÁMPARAS LED

MÓDULOS



CFx 88
Megaman



MHx 88
Megaman



THx 111 89
Megaman



THx 50 89
Megaman



AR70 261
MMelectric

AR111



GU10 95
Megaman



GU10 183
Soraa



G53 92
Megaman



G53 183
Soraa



GX8.5 91
Megaman



Hybrid Colour 94
Megaman



Dim to warm 96
Megaman



Dual Beam 96
Megaman



Perfect White 98
Megaman

PAR



Par 20 102
Megaman



Par 30L 102
Megaman



Par 30S 102
Megaman



Par 30S 102
Megaman



Par30S 184
Soraa



Par30L 184
Soraa



Par 38 103
Megaman



Par 38 Plantas 104
Megaman



Par 38 103
Megaman



Par38 185
Soraa



Par 56 Piscina 261
MMelectric

ÍNDICE GENERAL

MEGAMAN ELÉCTRICA

LÁMPARAS LED

PAR 16 GU10



Professional 106
Megaman



Hybrid Colour
Megaman



Smart 108
Megaman



Economy 109
Megaman



Basic 110
Megaman



Bluetooth 107
Megaman



Glaze 110
Megaman



Colores 256
MMelectric



VIVID 182
Soraa



Dim to
warm 108
Megaman



Dual
Beam 110
Megaman

MR16 GU 5.3



Professional 112
Megaman



Smart 113
Megaman



Economy 113
Megaman



Colores 257
MMelectric



VIVID 182
Soraa



G4 35mm 114
Megaman

MR11

REFLECTORAS



R50 255
MMelectric



R63 115
Megaman



R63 255
MMelectric



R80 115
Megaman



R80 255
MMelectric



R90 255
MMelectric

VELA



Smart Megaman 117



Economy Megaman 117



Basic Megaman 117

PING PONG



Smart Megaman 118



Economy Megaman 118

ESFÉRICA



Economy Megaman 119

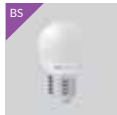

Basic Megaman 119

GLOBO



Smart Megaman 121



Economy Megaman 121

INCANDA



Incandled 134

ESTÁNDAR



Smart Megaman 123



Economy Megaman 123



Basic Megaman 123



Bluetooth Megaman 125



Dim to warm Megaman 124



360° Megaman 124



Sensor Light Megaman 125



Plantas Megaman 104



Color Ball Lightme 265

CÚPULA



Smart Megaman 126

LILIPUT



Economy Megaman 126

T-LAMP



Economy Megaman 126

NIGHT LED



Night Kids 121

ÍNDICE GENERAL

MEGAMAN ELÉCTRICA

LÁMPARAS LED

BI-PIN G9



Smart Megaman 127



Economy Megaman 127



G9 MMelectric 258

BI-PIN G4



Smart Megaman 127



Economy Megaman 127

LINEAL



Smart Megaman 128



Smart Megaman 128



Smart Megaman 128



R7s Lightme 264

LINESTRA



Linestra Lightme 264

SELLITE



Smart Megaman 129

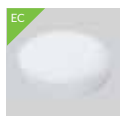

Economy Megaman 129

TUBOS



Economy Megaman 130



Basic MMelectric 260



Alimentación MMelectric 259

ALTAS POTENCIAS



Clusterlite Megaman 131



Street Lamp MMelectric 254



Titan MMelectric 252

12V



Standar Megaman 123

LÁMPARAS LED VINTAGE GOLDEN

FILAMENT 2200K



Vela 133
Megaman



Edison 133
Megaman



Estandar 133
Megaman



Globo 133
Megaman

VINTAGE 2200K



Edison 245
Black Smooth
MMelectric



Edison 245
MMelectric



Mini 245
Edison
MMelectric



Estandar 245
MMelectric



Estandar 245
Mate
MMelectric



Estandar 245
Cupula
MMelectric



Vela 246
MMelectric



Tubular 246
MMelectric



Magnum 247
MMelectric



Globo 246
Opal
MMelectric



Globo, Oro, Cobre y Plata 246
MMelectric



Lineal 246
MMelectric



Bullet 245
MMelectric

TWISTER 2200K



Edison 247
Black Smooth
MMelectric

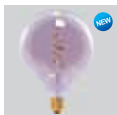

Globo 247
Black Smooth
MMelectric



Globo 247
MMelectric

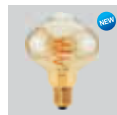

Alhambra 247
MMelectric

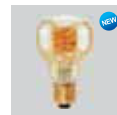

Softone 247
MMelectric



Plus 247
MMelectric

AMBAR 1800K



Edison 248
MMelectric



Elipsoidal 248
MMelectric

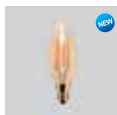

Vela 248
MMelectric



Globo 248
MMelectric

ÍNDICE GENERAL

MEGAMAN ELÉCTRICA

LÁMPARAS LED VINTAGE GOLDEN

GOLDEN RING

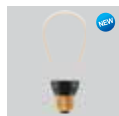

Edison 249
MMelectric



Globo 249
MMelectric

CURVE 2200K



Mini Edison 250
MMelectric



Edison 250
MMelectric



Globo 250
MMelectric

LIGHTBOTTLE



Lightbeer Original 240
Clara, Azul, Marrón y Verde
MMelectric



Lightbeer 241
Clara, Azul, Marrón y Verde
MMelectric



Lightwater 242
Azul, Amarilla, Black Smooth,
Rojo y Verde
MMelectric



Lightwine 243
Marrón y Verde
MMelectric

LÁMPARAS LED VINTAGE PLUMEN



001 188
Plumen



002 189
Plumen



003 190
Plumen

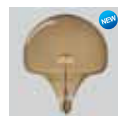

Wilma 193
Plumen

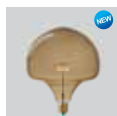

Willow 193
Plumen

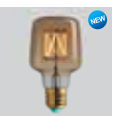

Wilbur 193
Plumen

LÁMPARAS CFL



Dicroicas 136
Megaman



Sellite 136
Megaman



Lineal 136
Megaman



AR111 136
Megaman



Reflectoras 137
Megaman



Esféricas 137
Megaman



Estándar 137
Megaman



Softone 137
Megaman



Vela 138
Megaman



Zenia 138
Megaman



Clusterlite 138
Megaman



Liliput 138
Megaman



Inyectables 139
Megaman



PLI 139
Inyectables
Megaman



Bi-Pin 139
Megaman



Dimables 139
Megaman

DRIVER / TRANSFORMADORES LED



Standar 268
Lumotech



Dimable 269
Lumotech



DALI 269
Lumotech



1-10V 270
Lumotech



Voltaje
Constante 271
Lumotech



Kit de
emergencia 272
Lumotech



Transformador 274
MMelectric



Luxia 274
BLV



Eco lig

MEC



MEGAMAN®

MEGAMAN® - LÍDER MUNDIAL EN ILUMINACIÓN

MEGAMAN® es una marca global que tiene productos de iluminación de bajo consumo de una larga vida útil. La marca ha tenido un crecimiento constante desde su fundación en 1994; Famosa por su amplia gama de lámparas CFL, ahora continuando su investigación y producción de lámparas y luminarias LED. Productos innovadores, eficientes y de gran calidad para la industria de la iluminación. Marca reconocida y posicionada entre las marcas mas relevantes y punteras de la iluminación.

MEGAMAN® cubre su distribución en todo el mundo en más de 90 países de Europa, Asia Pacífico, Oriente Medio, África, América del Norte y del Sur. Mediante el establecimiento de la gestión ambiental como una de las principales prioridades de la compañía, MEGAMAN® se centra en los procesos ambientales respetuosos del medio ambiente, desde el diseño inicial hasta la fabricación, investigación y desarrollo, y la eliminación y reciclaje de sus productos.



1.000.000 de encendidos



2018

Luminarias de carril MARCO, integrada y CRI97 Ultra Rich Colour. Tecnología Dual Beam, cambia el haz de luz de una forma sencilla y práctica.

2017

Lanzamiento de Perfect White, Hybrid Colour y Ultra Hybrid colour. La verdadera reproducción de los colores.

2016

Módulos led TECOH® THx para la industria retail. Presentación Gama Hybrid. Mejora de eficiencia lumínica de lámparas y luminarias Led.

2014

Lanzamiento del primer programa de iluminación inteligente, INGENIUM® BLU. Creación de la primera gama completa de Dim to Warm.

2013

Integración de tecnología LED en Luminarias.

2012

Módulos LED patentado - TECOH® MHX. TECOH® CFx - Primer modulo led del mundo con 2000 Lm y certificación Zhaga.

2011

La tecnología R9 introducida en la gama LED. La primera certificación de laboratorio NVLAP para los productos LED.

2010

Puesto en marcha la primera Estandar y Vela MEGAMAN® LED. Abre la oficina Internacional de Marketing en Europa.

2009

La innovadora tecnología térmica conductiva carretera TM incorporado en MEGAMAN® reflectores LED. certificación de laboratorio NVLAP para los productos CFL.

2008

La tecnología de amalgama se emplea en gama completa CFL.

2007

La tecnología DIMMERABLE® introdujo a la gama CFL.

2005

La tecnología DorS introducida a la gama CFL. Primeros RoHS obediente CFL. MEGAMAN® lámparas globales, la venta en más de 90 países.

2004

La tecnología INGENIUM® se introduce en las lámparas CFL para una larga vida y el tiempo de precalentamiento corto.

2002

Creamos la primera CFL GU10 reflector. Introducido tecnología de protección con silicona a la gama CFL.

1999

Tecnología patentada de refrigeración de tubo introducido al rango de CFL.

1997

Lanzamiento de la primera VELA de CFL.

1996

Lanzamiento de la primera ESTANDAR de CFL.

1994

MEGAMAN®.



Sistemas de Gestión de Calidad y rigurosa

Todos los productos MEGAMAN® están fabricados, diseñados probados y testados en nuestras propias fábricas. MEGAMAN® ofrece productos innovadores, fiables y seguros con los estándares de alta calidad ahora y en el futuro.

Para garantizar que los productos MEGAMAN® cumplen con los estándares más altos de calidad, las plantas de fabricación de la compañía están equipadas con sus propias líneas de montaje. El laboratorio rige bajo la normativa ISO 17025 certificado por CNAS y NVLA, y marcas UL, Intertek y TÜV.

MEGAMAN® ha llevado a cabo una serie de acreditaciones internacionales. Éstas incluyen:

Sistemas de Gestión de Calidad de lámparas y luminarias

MEGAMAN® son fabricados y certificados con la norma ISO 9001:2008, ISO 14001:2004, ISO 140641:2006, OHSAS 18001:1999, SA 8000:2008 y QC 080000:2005.

Responsabilidad social de las empresas

MEGAMAN® ha recibido OHSAS 18001:1999 y SA 8000:2008, lo que confirma el nivel de cuidado para los empleados un refuerzo compromiso de la empresa para ser socialmente responsable.

Control del uso de sustancias peligrosas

El control de la utilización de sustancias peligrosas MEGAMAN® QC 080000 certificada, se subrayaba el hecho de que los procesos de fabricación de la compañía son controladas cuidadosamente para garantizar el máximo control de sustancias peligrosas.



Innovación y productos exclusivos

Con nuestro diseño patentado y tecnología LED, MEGAMAN® lámparas y luminarias son capaces de ofrecer un excelente rendimiento, un bajo consumo de energía. Los productos Megaman son reconocidos en todo el mundo por ser los mas avanzados tecnológicamente y de cuidado diseño. Es por ello que la marca es una herramienta de uso para el mercado profesional.

Introducción de una nueva era en la iluminación LED y soluciones de luminarias

Características únicas

- Sustitución eficiente de energía para lámparas CFL, halogenuros metálicos, halógenas e incandescentes.
- Ofrecer un rendimiento excelente de iluminación.
- Alta eficacia luminosa de hasta 140 Lm x W.
- Alto mantenimiento del flujo luminoso: puntuación de mantenimiento lumínico del 70% (L70) de hasta 50.000 horas de vida.
- Alto rendimiento cromático hasta Ra94.
- Consistencia de la temperatura de color alta.
- Larga vida de hasta 50.000 horas.
- Productos ligeros y fáciles de instalar.
- Ahorro de alta energía alto.
- Sin radiación UV e IR.

Beneficio adicional

- Libre de mercurio.
- Conexión rápida.
- Amplia gama de funcionamiento de temperaturas.

Aplicaciones y usos

- Hospitales.
- Tiendas / Boutiques.
- Oficina.
- Residencial.
- Decorativo.
- Industrial.
- Exteriores y jardines.
- Etc...



LUMINARIAS LED EMPOTRABLES FIJOS



Siena 20



Siena SR 22



Rico 24



Genoa 26



Conxento 27



Envy 28



Estela Panel 1 30



Estela Panel 2 31



Berto 32

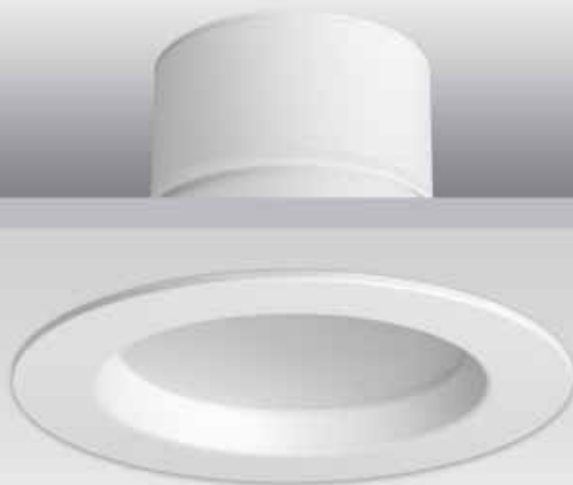

SIENA

MEGAMAN® SIENA es una gama downlights LED con driver y led integrado que facilita la instalación. Una luminaria led de empotrar en un solo elemento.

Ideal para sustituir los downlights convencionales de cualquier potencia y medida.

Esta gama está disponible con índice de protección IP44 para ampliar los espacios donde pueden ser instalados.



230V	UGR ≤25	IP44	Class II	BLANCO
------	---------	------	----------	--------

	COD	REF. INT	W	TC	LM	CRI	△	●	↗	⌚	PVR
★	38355	F27100RC	7,5W	2800K	550	80	90°	NO	130	25000h	20€
★	38362	F27100RC	7,5W	4000K	550	80	90°	NO	130	25000h	20 €
★	36719	F26200RC-d	13W	2800K	900	80	60°	SI	110	25000h	25 €
★	36726	F26200RC-d	13W	4000K	900	80	60°	SI	110	25000h	25 €
★	38379	F26300RC	20,5W	2800K	1560	80	90°	NO	172	25000h	30 €
★	38386	F26300RC	20,5W	4000K	1560	80	90°	NO	172	25000h	30 €
★	50425	F27100RCv1	20,5W	4000K	1560	80	90°	NO	225	25000h	30 €

No necesita driver. Medidas en milímetros.



Siena 7,5W

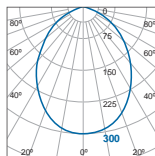
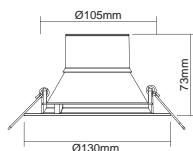

m	Lux	Ø cm
0.5	1200	100
1	300	200
1.5	133	300
2	75	400

Beam angle = 90°



Siena 13W

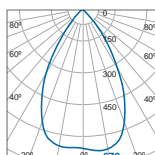
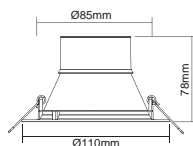

m	Lux	Ø cm
0.5	2680	58
1	670	115
1.5	298	173
2	168	231

Beam angle = 60°



Siena 20,5W

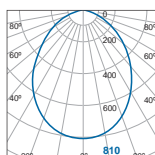
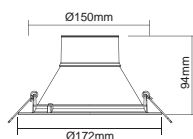

m	Lux	Ø cm
0.5	3240	100
1	810	200
1.5	360	300
2	203	400

Beam angle = 90°



Siena 20,5W

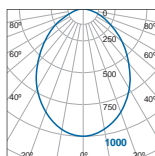
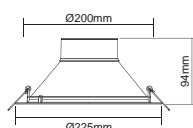

m	Lux	Ø cm
0.5	4000	100
1	1000	200
1.5	444	300
2	250	400

Beam angle = 90°



SIENA SR

MEGAMAN® SIENASR, con características similares a la versión Siena estándar, la serie SR ofrece una reflexión de la luz para garantizar un mayor confort visual y así evitar el deslumbramiento.

Ideal para sustituir los downlights convencionales de cualquier potencia y medida.

Esta gama está disponible con índice de protección IP44 para ampliar los espacio donde pueden ser instalados.







230V

UGR
≤22

IP44

Class
II

BLANCO

COD	REF. INT	W	TC	LM	CRI					PVR
46763	F54000RC	6W	2800K	550	80	90°	NO	130	50000h	25 €
46770	F54000RC	6W	4000K	550	80	90°	NO	130	50000h	25 €
46787	F54100RC-d	10,5W	2800K	950	80	90°	SI	110	50000h	29,17 €
46794	F54100RC-d	10,5W	4000K	950	80	90°	SI	110	50000h	29,17 €
46800	F54300RC	19W	2800K	2000	80	90°	NO	225	50000h	41,67 €
46817	F54300RC	19W	4000K	2000	80	90°	NO	225	50000h	41,67 €
46824	F54300RCv1	25,5W	2800K	2700	80	90°	NO	225	50000h	50 €
51446	F54300RCv1	25,5W	4000K	2700	80	90°	NO	225	50000h	50 €

No necesita driver. Medidas en milímetros.



Siena SR 6W

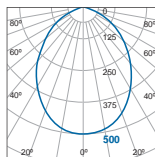
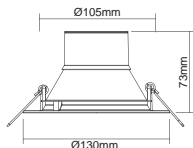

m	Lux	Ø cm
0.5	2000	100
1	500	200
1.5	222	300
2	125	400

Beam angle = 90°



Siena SR 10,5W

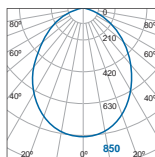
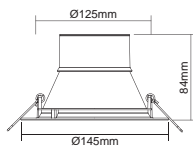

m	Lux	Ø cm
0.5	3400	100
1	850	200
1.5	378	300
2	213	400

Beam angle = 90°



Siena SR 19W

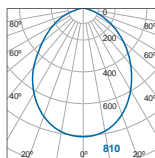
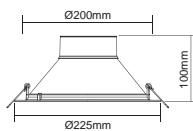

m	Lux	Ø cm
0.5	3240	100
1	810	200
1.5	360	300
2	203	400

Beam angle = 90°



Siena SR 25,5W

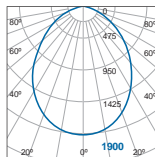
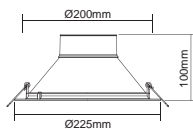

m	Lux	Ø cm
0.5	7600	100
1	1900	200
1.5	844	300
2	475	400

Beam angle = 90°



RICO
EMPOTRAR FIJO



MEGAMAN® RICO es una gama de downlights ultra finos. Es ideal para cualquier hueco con una profundidad limitada. Disponible en 3 versiones: Standar, regulación 1-10V y regulación DALI.

COD	REF. INT	+ DRIVER	W	TC	LM	CRI	△	●	↗	🕒	PVR
52375 + 47241	F29800RC	Standar	19W	4000K	1560	80	110°	NO	172	25000h	27,50 €
52375 + 47395	F29800RC	1-10V	19W	4000K	1560	80	110°	SI	172	25000h	33,33 €
52375 + 47425	F29800RC	DALI	19W	4000K	1560	80	110°	SI	172	25000h	41,67 €
52382 + 47258	F29900RCv1	Standar	25W	4000K	2000	80	110°	NO	225	25000h	34,17 €
52382 + 47401	F29900RCv1	1-10V	25W	4000K	2000	80	110°	SI	225	25000h	42,50 €
52382 + 47432	F29900RCv1	DALI	25W	4000K	2000	80	110°	SI	225	25000h	55 €

Driver incluido. Las medidas están dadas en milímetros.



Rico 19W

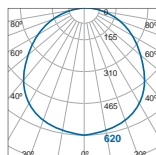
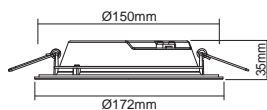

m	Lux	Ø cm
0.5	2480	143
1	620	286
1.5	276	428
2	155	571

Beam angle = 110°



Rico 25W

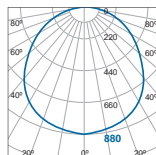
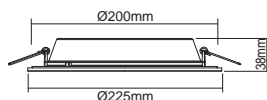

m	Lux	Ø cm
0.5	3520	143
1	880	286
1.5	391	428
2	220	571

Beam angle = 110°





GENOA

Zhaga

El downlight **GENOA** es el primer downlight led del mercado que ofrece una garantía de preservar la luminaria para toda la vida, únicamente cambiando la fuente de luz led. Para ello es tan sencillo como sustituir el módulo LED **TECOH CFX** una vez finalice su vida útil. Downlight LED multipotencia donde poder instalar módulo de 20w ó de 30w en función de las necesidades lumínicas. Sin fuente de alimentación externa y regulable.

El modelo **GENOA** ofrece una reflexión de la luz para garantizar un mayor confort visual y así evitar el deslumbramiento.

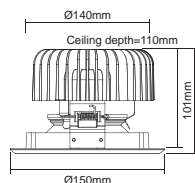

COD	REF. INT	W	LÁMPARA	COLOR	CRI	▲	●	⌚	PVR
36429	F25245RC/SV	20-30W	Tecoh Cfx	●	82-85	90°	SI	25000h	50 €
36412	F25245RC/WH	20-30W	Tecoh Cfx	○	82-85	90°	SI	25000h	50 €
36436	F25245RC/BK	20-30W	Tecoh Cfx	●	82-85	90°	SI	25000h	50 €

No necesita driver. Se suministra sin lámpara.

Genoa - Tecoh Cfx 20W

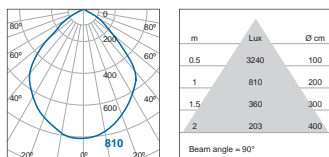

Genoa - Tecoh Cfx 30W

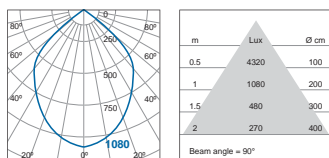



Tecoh Cfx

MÓDULOS LED

La luminaria GENOA monta el módulo led techo Cfx. Ver más características de las lámpara en página 88.

COD	W	V	TC	LM
33015	20W	230V	2800K	1100
33022	20W	230V	4000K	1200
33039	30W	230V	2800K	1800
33046	30W	230V	4000K	2000



CONXENTO

Luminaria para empotrar de reducidas dimensiones. Conexión a 230V directo. Ligera y fácil de instalar. Lámpara led reemplazable de diferentes potencias y tonalidades de luz.

CONXENTO ofrece una reflexión de la luz para garantizar un mayor confort visual y así evitar el deslumbramiento.

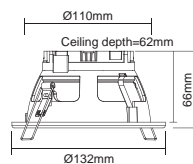

COD	REF. INT	Max. W	☐	COLOR	CRI	☒	PVR
02424	L0503RCBK	7W	GX53	●	80	90°	7,50 €
02431	L0503RCSV	7W	GX53	●	80	90°	9 €

Se suministra sin lámpara.



LÁMPARA SELLITE

La luminaria CONXENTO puede montar la lámpara Sellite de LED o CFL.



Pg 129



Pg 129



Pg 136



ENVY

Luminaria diseñada y adaptada para la amplia gama de lámparas LED PAR16 de **MEGAMAN®**. Luminaria para aplicaciones exteriores y lugares húmedos gracias a su protección IP65.

Muy ligera y fácil de instalar.

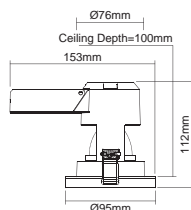

Lámpara PLI 11W



COD	REF. INT	W	TC	LÁMPARA	INT.	COLOR	PVR
★ 06972	F05717RC	*	-	PAR 16	GU10	●	20,83 €
★ 06958	F05730RC	11W	3000K	-	PLi	●	20,83 €
★ 06965	F05730RC	11W	4000K	-	PLi	●	20,83 €

* Se suministra sin lámpara. 🇪🇸 Últimas unidades



LÁMPARA PAR 16 GU10

La luminaria ENVY puede montar la lámpara Par 16 GU10 de LED o CFL.



Pg 106



Pg 108



Pg 109



Pg 110





PANEL SERIES



Estela
Panel 1

30



Estela
Panel 2

31



Berto

32



ESTELA



230V

UGR
≤19

IP20

Class
I

BLANCO

Nueva generación de luminarias modulares con estética innovadora.

- Sustituto perfecto para pantallas T5 y T8.
- Proporciona alta eficacia luminosa de 103 Lm / W.
- Permite un ahorro de energía considerable y una larga vida útil.
- Ahorro de costes innecesarios.
- Driver integrado en la luminaria.
- **Opción de versión con regulación DALI ó 1-10V con driver externo.**
- Confort visual e índice de deslumbramiento bajo para evitar la fatiga.
- Ángulo de haz amplio de 90°, ideal para la iluminación general y de oficinas.



ESTELA 1

UGR ≤19	IP20
Class I	BLANCO

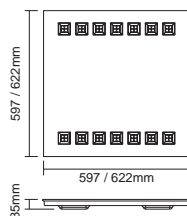

598x598	

COD	REF. INT	W	TC	LM	CRI				PVR
46558	FPL62400V0	30W	4000K	3500	80	90°	600x600	50000h	92 €
46565	FPL62400V0	30W	6500K	3500	80	90°	600x600	50000h	92 €

Driver incluido. Las medidas están dadas en milímetros.



ESTELA 2

UGR ≤19	IP20
Class I	BLANCO

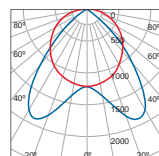
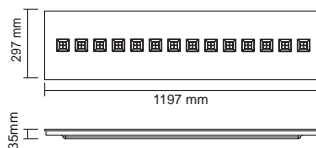

298x1198	

COD	REF. INT	W	TC	LM	CRI				PVR
46572	FPL62500V0	30W	4000K	3500	80	90°	1197x297	50000h	100 €
46589	FPL62500V0	30W	6500K	3500	80	90°	1197x297	50000h	100 €

Driver incluido. Las medidas están dadas en milímetros.

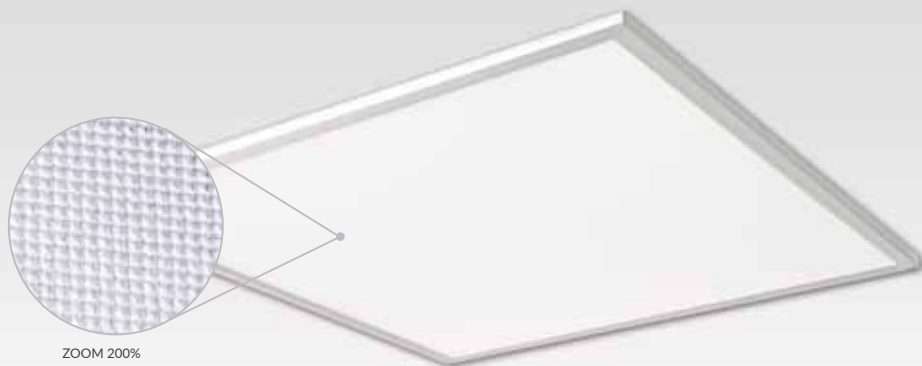

ZOOM 200%

BERTO PRISMATIC PANEL



• Opción de versión con regulación DALI ó 1-10V con driver externo.

- La solución perfecta de ahorro de energía da hasta 98 Lm / W.
- Sustitución directa de luminarias T5 y T8.
- Difusor opal que ofrece un confort visual y evita la fatiga de los ojos.
- Ofrece ángulo de haz amplio que es ideal para la iluminación general.

230V	UGR ≤19	IP20	Class III	BLANCO
------	---------	------	-----------	--------

COD	REF. INT	W	TC	LM	CRI	△	↕	🕒	PVR
38683	F33400RCv1+LA11016	39W	3000K	3350	80	120°	600x600	50000h	58 €
38690	F33400RCv1+LA11016	39W	4000K	3600	80	120°	600x600	50000h	58 €
51200	F33400RCv2+LA11016	39W	6000K	3800	80	120°	600x600	50000h	58 €

Driver incluido. Las medidas están dadas en milímetros. Consultar versión DALI y 1-10V

Berto 600x600 mm

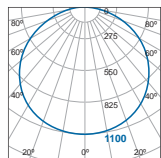
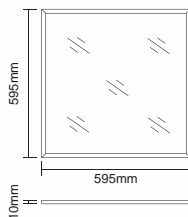

m	Lux	Ø cm
0.5	4400	173
1	1100	346
1.5	489	520
2	275	693



Beam angle = 120°



BERTO PANEL 

- La solución perfecta de ahorro de energía da hasta 98 Lm / W.
- Sustitución directa de luminarias T5 y T8.
- Difusor opal que ofrece un confort visual y evita la fatiga de los ojos.
- Ofrece ángulo de haz amplio que es ideal para la iluminación general.

230V	UGR ≤19	IP20	Class III	BLANCO
------	------------	------	--------------	--------

COD	REF. INT	W	TC	LM	CRI				PVR
38720	F33600RC+LA11067	34W	3000K	3000	80	120°	600x1200	50000h	100 €
38737	F33600RC+LA11067	34W	4000K	3250	80	120°	600x1200	50000h	100 €
53044	F33600RCv1+LA11067	52W	4000K	5100	80	120°	600x1200	50000h	148 €

Driver incluido. Las medidas están dadas en milímetros. Consultar versión DALI y 1-10V

Berto 600x1200 mm

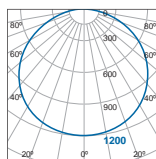
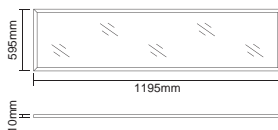

m	Lux	Ø cm
0.5	4800	173
1	1200	346
1.5	533	520
2	300	693

Beam angle = 120°

ACCESORIOS

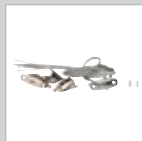

Superficie
Cod. 38744

Empotrar
Cod. 38751

Suspensión
Cod. 38768

Marco de superficie 600x600
Cod. 51279

37,50 €

Marco de superficie 1200x600
Cod. 51286

54,15 €



LUMINARIAS LED EMPOTRABLES ORIENTABLES



Vito 36



Carlo 37



Zeki AR111 38



Zeki 50 39



Rico HR 40



Anna 41



Abby 42



Foco 43



Siena Mini 44



Kara 47



VITO 

 Zhaga

Diseñado para retail y aplicaciones de iluminación general, **MEGAMAN® VITO** tiene una construcción que proporciona la inclinación multi-direccional de la luz.

Integrado con **MEGAMAN® TECOH® RDx** módulo LED, la luminaria proporciona un increíble rendimiento de la iluminación de hasta 5600lm junto con 50.000 horas de vida útil que lo convierte en una solución de reemplazo de lámparas de halógeno metálico, ofreciendo un ahorro considerable.

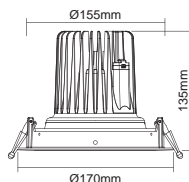

COD	REF. INT	W	TC	LM	COLOR	CRI	△	☾	🕒	PVR
-	F29349RC-p	45W	3000K	4100	○	82	35°	SI	50000h	200 €
42635	F29349RC	45W	3000K	5100	●	82	35°	SI	50000h	250 €
42642	F29349RC	45W	4000K	5600	○	82	35°	SI	50000h	250 €

Driver incluido - Versión Perfect White no incluye driver - Módulo incluido - Consultar disponibilidad

Vito - 35°

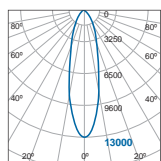

m	Lux	Ø cm
0.5	52000	32
1	13000	63
1.5	5778	95
2	3250	126

Beam angle = 35°



Vito - 60°

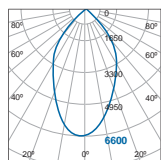

m	Lux	Ø cm
0.5	28400	58
1	6600	115
1.5	2933	173
2	1650	231

Beam angle = 60°



CARLO



Zhaga

Diseñado para retail y aplicaciones de iluminación general, **MEGAMAN® CARLO** tiene una construcción que proporciona la inclinación multi-direccional de la luz.

Integrado con **MEGAMAN® TECOH® RDx** módulo LED, la luminaria proporciona un increíble rendimiento de la iluminación. Con 50.000 horas de vida útil que lo convierte en una solución de reemplazo de lámparas de halogenuro metálico, ofreciendo un ahorro considerable.

230V

IP20

Class III

DIMABLE

BLANCO

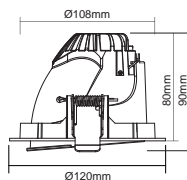

Ø108

106g

35°

45°

COD	REF. INT	W	TC	LM	COLOR	CRI	△	☾	⌚	PVR
-	F28249RC-p	34W	3000K	2400	○	82	35°	SI	50000h	200 €
42659	F28249RC	39W	3000K	3600	●	82	35°	SI	50000h	158,33 €
42666	F28249RC	39W	4000K	4500	○	82	35°	SI	50000h	158,33 €

Driver incluido - Módulo incluido - Consultar disponibilidad

Carlo - 35°

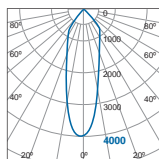

m	Lux	Ø cm
0.5	16000	32
1	4000	63
1.5	1778	95
2	1000	128

Beam angle = 35°



ZEKI 111

LUMINARIAS | EMPOTRAR ORIENTABLE

MEGAMAN®



ZEKI 111

- Luminaria cardan multidireccional para el nuevo módulo **TECOH ARx 111** y **TECOH THx 50**.
- **TECOH ARx 111** de 3200 Lm. Hasta 9600 Lm en la versión de tres puntos de luz.
- **TECOH THx 50** de 900 Lm. Hasta 1 vlm en la versión de tres puntos de luz.
- Empotrable ideal para cadenas Retail, galerías, museos, etc...
- Ahorro considerable frente a lámparas y equipos de halogenuro metálico y halógenos.



ARx Ø111 - Pg 89



51217 - PVP 5€



51484 - PVP 5€

IP23

BLANCO

GRIS

NEGRO

COD	REF. INT	Nº LUCES	COLOR	↕	PVR
46831	F56353RC	1	○	176x176	20 €
46855	F56353RC	1	●	176x176	20 €
46848	F56353RC	1	●	176x176	20 €
46862	F56453RC	2	○	176x322	30 €
46886	F56453RC	2	●	176x322	30 €
46879	F56453RC	2	●	176x322	30 €
46893	F56553RC	3	○	176x467	40,83 €
46916	F56553RC	3	●	176x467	40,83 €
46909	F56553RC	3	●	176x467	40,83 €

Las medidas están dadas en milímetros. Módulo ARx no incluido

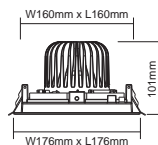

160x160



45°

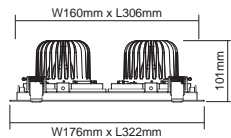

160x306



30°

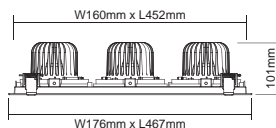

160x452



30°





ZEKI 50

IP23	BLANCO	GRIS	NEGRO
------	--------	------	-------

COD	REF. INT	Nº LUCES	COLOR		PVR
46923	F55752RC	1	○	89x89	11,67 €
50432	F55752RC	1	●	89x89	11,67 €
50449	F55752RC	1	●	89x89	11,67 €
46930	F55852RC	2	○	89x165	15,83 €
50456	F55852RC	2	●	89x165	15,83 €
50463	F55852RC	2	●	89x165	15,83 €
46947	F55952RC	3	○	89x242	21,67 €
50470	F55952RC	3	●	89x242	21,67 €
50487	F55952RC	3	●	89x242	21,67 €

Las medidas están dadas en milímetros. Módulo THx no incluido

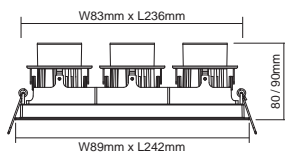
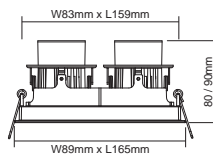
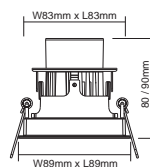



RICO HR ULTRA SLIM NEW



- El reemplazo ideal lámparas halógenas.
- Medida ideal para el reemplazo directo y sin complicaciones.
- Hasta 900lm y 50.000 de vida.
- IP44 clasificado para lugares húmedos como el cuarto de baño y cocinas.
- Dimable para la versión Ultra Slim.
- Directo a 230V para la versión Economy.
- Opcional: versión DALI y 1-10V

DC16 - 21V	IP44	Class III
BLANCO		

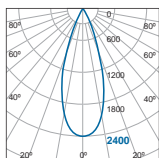

m	Lux	Ø cm
0.5	9600	32
1	2400	65
1.5	1067	97
2	600	130

Beam angle = 36°

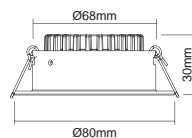

COD	REF. INT	W	TC	Lm	COLOR	CRI				PVR
46473	F53500RCv2	9W	2800K	900	○	80		SI	50000h	40 €
46480	F53500RCv2	9W	4000K	900	●	80		SI	50000h	40 €

Driver incluido



RICO HR ECONOMY NEW

230V	IP23	BLANCO
------	------	--------

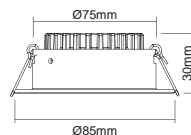

COD	REF. INT	W	TC	Lm	COLOR	CRI				PVR
46503	F55100RCv2	7W	4000K	420	○	80		NO	25000h	14 €

Driver integrado



ANNA **NEW**

MEGAMAN® ANNA LED downlight integrado. Luminaria de empotrar basculante con reflector Hybrid patentado por Megaman ofrece la posibilidad de cambiar el marco / embellecedor de forma circular o cuadrada de una manera muy sencilla y práctica ya que está imantado. Diámetro de corte 68mm para facilitar su instalación en sustitución de lámparas par16 GU10 + aro + portalámparas. Índice de protección IP44 para su uso en baños, aseos, zonas de humedad ó en exteriores.



230V	IP44	Class II	BLANCO
------	------	----------	--------

COD	REF. INT	W	TC	Lm	COLOR	CRI	△	☾	🕒	PVR
53860	FDS70000v0	5W	2800K	500	○	80	36°	NO	25000h	15,50 €
-	FDS70000v0	5W	4000K	500	●	80	36°	NO	25000h	15,50 €
53877	LA10052	-	-	-	○	-	-	-	-	1,50 €
53884	LA10053	-	-	-	●	-	-	-	-	1,50 €

EMBELLECEDOR MAGNÉTICO

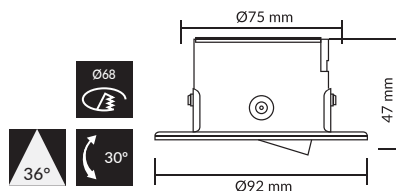



IP23

BLANCO

NEGRO

ABBY

- Funciona con **TECOH® THX 50** para la sustitución de los tradicionales halógenos de 50W.
- Fácil de instalar. Con tensión directa a 230V y sin fuentes de alimentación externa.
- Luminaria LED de diseño innovador para espacios reducidos e iluminar con haz de luz concentrado.
- Wall wash: bañador de pared con ángulo de inclinación de 30°, para buscar un efecto deseado.

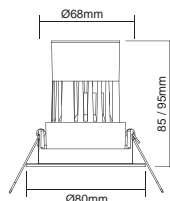

ABBY PIN-HOLE



COD	REF. INT	COLOR	Ø	PVR
52368	F54952RC	○	80	20 €
-	F54952RC	●	80	20 €

Las medidas están dadas en milímetros. Módulo THx no incluido

ABBY WALL WASH



COD	REF. INT	COLOR	Ø	PVR
-	F55052RC	○	80	20 €
-	F55052RC	●	80	20 €

Las medidas están dadas en milímetros. Módulo THx no incluido



FOCO

MEGAMAN® FOCO está diseñado para incorporar una lámpara LED PAR16 de Megaman.

- Angulo de inclinación de 30°.
- Fácil de instalar.
- Directo a 230V.

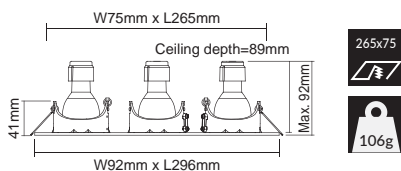
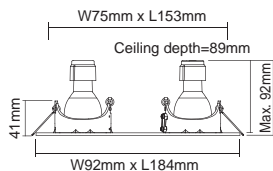

COD	REF. INT	V	LÁMPARA			COLOR	PVR
★ 22026	F12817RC	230V	2 x PAR 16	GU10	82x184	●	10 €
★ 22033	F12917RC	230V	3 x PAR 16	GU10	92x296	●	15 €

Se suministra sin lámpara - Las medidas son en milímetros. 🇪🇸 Últimas unidades



LÁMPARA PAR 16 GU10

La luminaria FOCO puede montar la lámpara Par 16 GU10 de LED o CFL.



Pg 106



Pg 108



Pg 109



Pg 110

SIENA MINI

LUMINARIAS | EMPOTRAR ORIENTABLE

MEGAMAN®



SIENA MINI

EMPOTRAR ORIENTABLE



Luminaria LED integrada con tecnología **DIM TO WARM**. Reemplaza las lámparas y luminarias tradicionales. Luminaria integrada de un solo elemento para facilitar su instalación. Atenúa la temperatura de color la luminaria desde 2700k hasta 1800k o lo que es lo mismo de luz cálida a luz muy cálida. Crea un ambiente acogedor y de confort para lograr el efecto deseado.

COD	REF. INT	W	TC	LM	COLOR	CRI	△	●	↕	⌚	PVR
42611	F28100RC-W	8W	2700K	500	○	80	36°	SI	80	25000h	33,33 €
42628	F29500RC-W	8W	2700K	500	○	80	36°	SI	80x80	25000h	33,33 €

No necesita driver - Medidas dadas en milímetros



Siena REDONDO

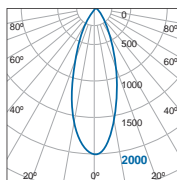
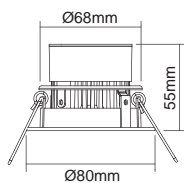

m	Lux	Ø cm
0.5	8000	32
1	2000	65
1.5	889	97
2	500	130

Beam angle = 36°



Siena CUADRADO

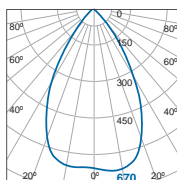
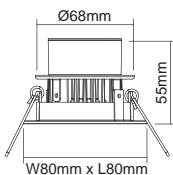

m	Lux	Ø cm
0.5	2680	58
1	670	115
1.5	298	173
2	168	231

Beam angle = 60°







KARA

MEGAMAN® KARA, un proyector de LED integrado, ofrece un excelente rendimiento de la iluminación - por lo que es una solución ideal para el reemplazo de halogenuros metálicos.

Proporciona una iluminación única y efectiva para vitrinas, paredes, escaparates, estantes o grandes exposiciones.

KARA incorpora el módulo TECOH FLx con una alta salida de lúmenes.

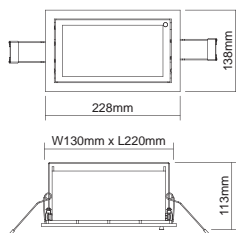
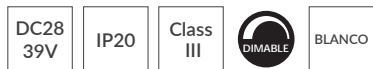

COD	REF. INT	W	TC	Lm	CRI	☒	☉	🕒	PVR
46534	F51800RC	26W	3000K	2200	80	100°	SI	25000h	100 €
46541	F51800RC	26W	4000K	2400	80	100°	SI	25000h	100 €
46510	F51700RC	43W	3000K	4100	80	100°	SI	25000h	141,67 €
46527	F51700RC	43W	4000K	4500	80	100°	SI	25000h	141,67 €

Driver incluido

Kara - 26W

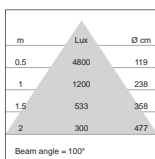
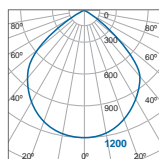

Kara - 43W

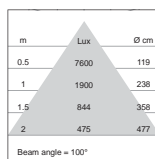
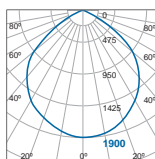



LUMINARIAS LED SUPERFICIE



Conxento 50



Delta T2 51



Pino 52



Keto 53



CONXENTO

Luminaria de superficie de reducidas dimensiones y de fácil instalación. Instalación directa a 230V gracias a la lámpara **GX53** de **MEGAMAN®**.

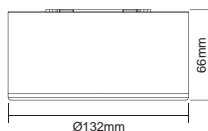

COD	REF. INT	Max. W		COLOR	CRI	△	PVR
02455	L0503CLBK	7W	GX53	●	80	90°	9,50 €
02462	L0503CLSV	7W	GX53	●	80	90°	11 €



Se suministra sin lámpara. 🚩 Últimas unidades

Conxento - GX53 - Máxima 7W

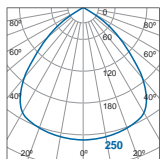

m	Lux	Ø cm
0.5	1000	100
1	250	200
1.5	111	300
2	63	400

Beam angle = 90°



LÁMPARA SELLITE

La luminaria CONXENTO puede montar la lámpara Sellite de LED o CFL.



Pg 129



Pg 129



Pg 136



DELTA T2

Regleta compacta fluorescente integrada de reducidas dimensiones y de fácil instalación.

DELTA T2 ideal para los bajos muebles de cocina y mobiliario comercial.

DELTA T2 cornisas para iluminación cornisas y evitar las zonas oscuras para las conexiones entre ellas.



ingenium®

230V

COD	REF. INT	W	TC	LM				PVR
07009	SB0123i	23W	3000K	1260	282	NO	18000h	8,33 €
07016	SB0123i	23W	4000K	1260	282	NO	18000h	8,33 €

Las medidas dadas son en milímetros. Últimas unidades



DELTA T2 CORNISA



ingenium®

230V

COD	REF. INT	W	TC	LM				PVR
07023	SB0308i	8W	3000K	440	344	NO	18000h	8,33 €
07030	SB0308i	8W	4000K	440	344	NO	18000h	8,33 €
20367	LA4006	CONEXIÓN LINEAL T2						2,43 €
20374	LA4003	CONEXIÓN FLEXIBLE T2						4 €

Las medidas dadas son en milímetros. Últimas unidades





PINO NEW

MEGAMAN® PINO es la regleta con tecnología LED de **MEGAMAN**.

La elección perfecta para superficie en la pared de la cocina, bajo muebles, iluminación comercial y aplicaciones ocultas de iluminación lineales. El diseño de tubo lineal de LED integrado con sistema de alta eficacia luminosa de hasta 100 Lm / W es un verdadero sustituto de tubos fluorescentes T8 Y T5 tradicionales.

CON INTERRUPTOR

230V

IP20

Class II

BLANCO

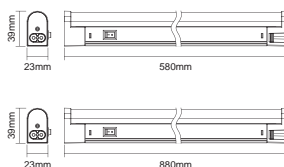

COD	REF. INT	W	TC	LM	CRI				PVR
46596	F29000SM	11W	3000K	1000	80	120°	NO	25000h	18 €
46602	F29000SM	11W	4000K	1100	80	120°	NO	25000h	18 €
46619	F29100SM	17W	3000K	1600	80	120°	NO	25000h	27 €
46626	F29100SM	17W	4000K	1700	80	120°	NO	25000h	27 €

Driver integrado

Pino - 11W - 3000K

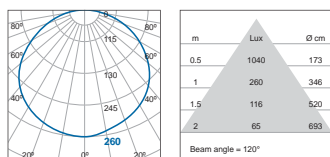

Pino - 17W - 3000K

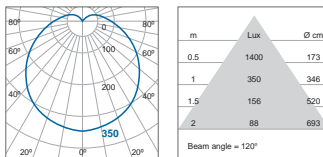

Pino - 11W - 4000K

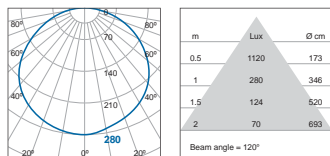

Pino - 17W - 4000K

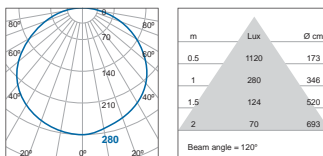



KETO

- Regleta LED integrada para sustituir T5 y T8.
- Dos enchufes extras para conectar aparatos eléctricos.
- Ofrece una alta eficacia luminosa de hasta 100 Lm / W
- Distribución de haz de luz amplio.
- El diseño simple y discreto.

230V	IP20	Class I	BLANCO
------	------	---------	--------

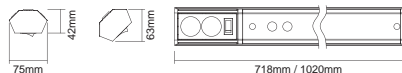

COD	REF. INT	W	TC	LM	CRI	△	●	↗	⌚	PVR
47098	F60000SM	9W	2800K	900	80	110°	NO	718	40000h	41,67 €
47104	F60000SM	9W	4000K	900	80	110°	NO	718	40000h	41,67 €
47111	F60100SM	14,5W	2800K	1450	80	110°	NO	1020	40000h	50 €
47128	F60100SM	14,5W	4000K	1450	80	110°	NO	1020	40000h	50 €

Driver incluido - Medidas dadas en milímetros



LUMINARIAS LED CARRIL



Marco Mini 56



Marco Midi 57



Marco 58



Modena 59



Alda 60



Toby 61



Corruna 62



Loft 63



Mosaic 64



Mora 65



MARCO MINI ULTRA HYBRID COLOURS

- Luminaria de carril LED con fuente de alimentación integrada.
- Diseño vanguardista e innovador.
- La tecnología **MEGAMAN® Hybrid Reflector**, ofrece un mejor control del haz de luz, gracias a su excelente óptica.
- Marco incorpora el nuevo chip led con **CRI97**.
- Accesorios opcionales disponibles incluyendo: rejilla de panel para mejorar el control del deslumbramiento.
- Aplicaciones: iluminación de tiendas, hoteles, salas de exposiciones, restaurantes, museos, etc.

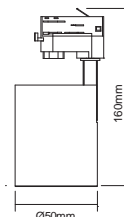

220V
240V

IP20

Class
II



BLANCO

NEGRO



COD	REF. INT	W	TC	LM	△	CRI	COLOR	☉	🕒	PVR
53570	FTK70000v0-r9+012d	12W	2800K	720	12°	90	○	NO	50000h	65 €
53594	FTK70000v0-ru+024d	12W	2800K	750	24°	97	○	NO	50000h	65 €
53617	FTK70000v0-ru+036d	12W	2800K	750	36°	97	○	NO	50000h	65 €
53587	FTK70000v0-r9+012d	12W	2800K	720	12°	90	●	NO	50000h	65 €
53600	FTK70000v0-ru+024d	12W	2800K	750	24°	97	●	NO	50000h	65 €
53624	FTK70000v0-ru+036d	12W	2800K	750	36°	97	●	NO	50000h	65 €

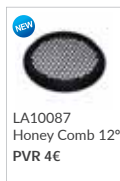



MARCO MIDI DUAL BEAM TECHNOLOGY

- Luminaria de carril LED con fuente de alimentación integrada.
- Diseño vanguardista e innovador.
- Nuevo reflector **Dual Beam Technology** de MEGAMAN.
- Marco incorpora el nuevo chip led con **CRI97**
- Dos luminarias en una sola versión.
- Elige el haz de luz que más te guste con solo pulsar la lente.
- Aplicaciones: iluminación de tiendas, hoteles, salas de exposiciones, restaurantes, museos, etc



PULSA LALENTE
Y CAMBIA EL HAZ DE LUZ

NEW

220V
240V

IP20

Class
II



BLANCO

NEGRO

± 90°

330°

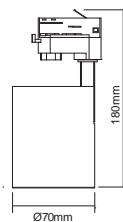

COD	REF. INT	W	TC	LM	△	CRI	COLOR	☾	🕒	PVR
58148	FTK70800v0-db/ru+025D045D	24W	2800K	2100	25°/45°	97	○	NO	50000h	90 €
58155	FTK70800v0-db/ru+025D045D	24W	4000K	2200	25°/45°	97	●	NO	50000h	90 €

DBT



¿QUE ES EL DUAL BEAM TECHNOLOGY?

DBT (Dual Beam Technology) , es la nueva óptica de Megaman que unido junto con el reflector te permite modificar el haz de luz de 24° a 45° y viceversa con solo pulsar la óptica de la luminaria . Sistema de Push and play.





MARCO ULTRA HYBRID COLOURS

- Luminaria de carril LED con fuente de alimentación integrada.
- Diseño vanguardista e innovador.
- La tecnología **MEGAMAN® Hybrid Reflector**, ofrece un mejor control del haz de luz, gracias a su excelente óptica.
- Marco incorpora el nuevo chip led con **CRI97**.
- Accesorios opcionales disponibles incluyendo: rejilla de panel para mejorar el control del deslumbramiento.
- Aplicaciones: iluminación de tiendas, hoteles, salas de exposiciones, restaurantes, museos, etc.



220V 240V	IP20	Class II	HIGH CRI97 COLOUR	BLANCO	NEGRO	±90°	330°	Flicker Free
--------------	------	----------	--------------------------	--------	-------	------	------	--------------

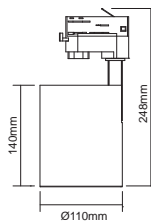

COD	REF. INT	W	TC	LM	△	CRI	COLOR	☉	🕒	PVR
53129	FTK70100v1-r	37W	3000K	2400	12°	97	○	NO	50000h	140 €
53143	FTK70100v1-r	37W	3000K	2600	25°	97	○	NO	50000h	140 €
53167	FTK70100v1-r	37W	3000K	2600	45°	97	○	NO	50000h	140 €
53136	FTK70100v1-r	37W	3000K	2400	12°	97	●	NO	50000h	140 €
53150	FTK70100v1-r	37W	3000K	2600	25°	97	●	NO	50000h	140 €
53174	FTK70100v1-r	37W	3000K	2600	45°	97	●	NO	50000h	140 €
53204	FTK70100v1-r	52W	3000K	3700	25°	97	○	NO	50000h	180 €
53228	FTK70100v1-r	52W	3000K	3700	45°	97	○	NO	50000h	180 €
53211	FTK70100v1-r	52W	3000K	3700	25°	97	●	NO	50000h	180 €
53235	FTK70100v1-r	52W	3000K	3700	45°	97	●	NO	50000h	180 €

NEW

LA10054
Spread lens
PVR 8€

NEW

LA10055
Rectangular lens
PVR 8€

NEW

53259
Honey Comb
PVR 6€

NEW

53242
Wings
PVR 22€

NEW

53266
Colour lens
PVR 8€

NEW

53273
Colour lens
PVR 8€

NEW

53280
Colour lens
PVR 8€

NEW

53297
Colour lens
PVR 8€



MODENA

Zhaga

Luminaria led de carril con tecnología **TECOH MHX** de **MEGAMAN®** con potencias de 24w y hasta 50w.

Ideal para sustituir luminarias convencionales de halogenuro metálico de 35w y 70w respectivamente.

Luminaria con lámpara intercambiable.

Diseño innovador y de cuidada estética para cadenas comerciales (Retail). MODENA tiene un ángulo de inclinación vertical de 90° y un ángulo de rotación horizontal 355° para la iluminación multidireccional.

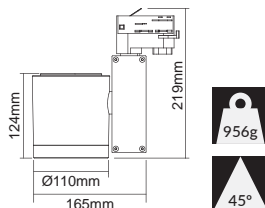
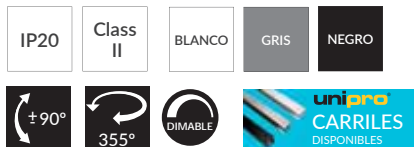

COD	REF. INT	W	TC	LM	CRI	COLOR		PVR
35385	F25343TK/SV	24W	3000K	2700	80	○	SI	200 €
35361	F25343TK/SV	24W	3000K	2700	80	●	SI	200 €
33992	F25343TK/SV	24W	3000K	2700	80	●	SI	200 €
35392	F25343TK/SV	24W	4000K	3000	80	○	SI	200 €
35378	F25343TK/SV	24W	4000K	3000	80	●	SI	200 €
34005	F25343TK/SV	24W	4000K	3000	80	●	SI	200 €

Se Suministra con módulo techoh MHx. Producto bajo consulta.



Tecoh MHx MÓDULOS LED

La luminaria Modena incorpora el módulo led techoh MHx.

Ver en página 88



ALDA

- Luminaria de carril para lámpara **LED AR111 GU10** de **MEGAMAN®**.
- Conexión directa a 230V.
- Temperatura de color 2800k y 4000k.
- Luz acentuada con ángulos de apertura de 8°, 24° y 45°.



230V	IP20	Class II	±90°	330°	DIMABLE	BLANCO	GRIS	NEGRO
------	------	----------	------	------	---------	--------	------	-------

COD	REF. INT	MAX. W	LÁMPARA		CRI	COLOR		PVR
46336	F26817TK	15W	AR111	GU10	82	○	SI	65 €
50500	F26817TK	15W	AR111	GU10	82	●	SI	65 €
41416	F26817TK	15W	AR111	GU10	82	●	SI	65 €

Se suministra sin lámpara AR111.

PS

**LÁMPARA LED
AR111 GU10**

Ver en la página 95.

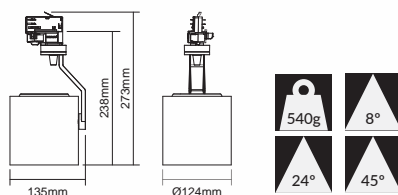



TOBY

- Luminaria de carril para lámpara **LED AR111 GU10** de **MEGAMAN®**.
- Conexión directa a 230V.
- Temperatura de color 2800k y 4000k.
- Luz acentuada con ángulos de apertura de 8°, 24° y 45°.
- Multidireccional.

230V	IP20	Class II	170°	340°	DIMABLE
BLANCO	GRIS	NEGRO			

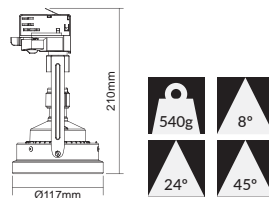

COD	REF. INT	MAX. W	LÁMPARA		CRI	COLOR		PVR
41447	F13117TK	15W	AR111	GU10	82	○	SI	33,33 €
41430	F13117TK	15W	AR111	GU10	82	●	SI	33,33 €
41423	F13117TK	15W	AR111	GU10	82	●	SI	33,33 €

Se suministra sin lámpara AR111.

PS

LÁMPARA LED
AR111 GU10

Ver en la página 95.



CORRUNA

- Luminaria de carril para lámpara **LED AR111 GU10** de **MEGAMAN®**.
- Conexión directa a 230V.
- Temperatura de color 2800k y 4000k.
- Luz acentuada con ángulos de apertura de 8°, 24° y 45°.
- Multidireccional.

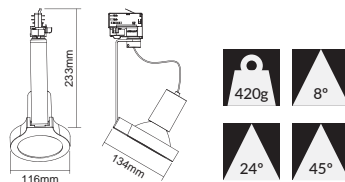

COD	REF. INT	MAX. W	LÁMPARA		CRI	COLOR		PVR
35422	F30417TK	15W	AR111	GU10	82	○	SI	38,33 €
34661	F30417TK	15W	AR111	GU10	82	●	SI	38,33 €

Se suministra sin lámpara AR111.

PS



LÁMPARA LED
AR111 GU10

Ver en la página 95.



LOFT

- Luminaria de carril para lámpara **LED AR111 GU10** y **LED PAR 38** de MEGAMAN®.
- Conexión directa a 230V.
- Temperatura de color 2800k y 4000k.
- Luz acentuada con ángulos de apertura de 8°, 24° y 45° para la lámpara **LED AR111 GU10**.
- Hasta 1200 Lm de salida con la lámpara **LED PAR38**.



230V	IP20	Class II	250°	330°	DIMABLE	BLANCO	GRIS	NEGRO
------	------	----------	------	------	---------	--------	------	-------

COD	REF. INT	MAX. W	LÁMPARA		CRI	COLOR		PVR
27014	L0601TKWH12	20W	PAR 38	E27	80	○	SI	35,42 €
27137	L0601TKBK12	20W	PAR 38	E27	80	●	SI	35,42 €
20343	F12617TKSV22	15W	AR111	GU10	80	●	SI	35,42 €

Se suministra sin lámpara. Producto bajo consulta.

Loft AR111 GU10

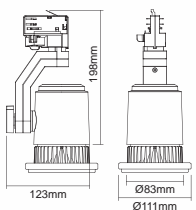

Loft PAR 38

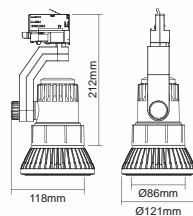

PS



LÁMPARA LED
AR111 GU10

Ver en la página 95.

PS



LÁMPARA
PAR 38

Ver en la página 103.



MOSAIC

Luminaria de carril para lámpara **LED PAR16** de **MEGAMAN®**.
Conexión directa a 230V.

Múltiples opciones gracias a la gran variedad de modelos
existentes de lámpara **LED PAR16**.

230V	IP20	Class II	DIMABLE
BLANCO	GRIS	NEGRO	unipro CARRILES DISPONIBLES

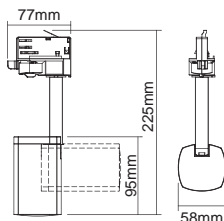

161g	330°	90°
------	------	-----

COD	REF. INT	MAX. W	LÁMPARA		CRI	COLOR		PVR
50517	F11517TK	8W	PAR 16	GU10	82	○	SI	23,33 €
50524	F11517TK	8W	PAR 16	GU10	82	●	SI	23,33 €
50531	F11517TK	8W	PAR 16	GU10	82	●	SI	23,33 €

Se suministra sin lámpara.

LÁMPARA PAR 16 GU10

La luminaria Mosaic puede montar la lámpara Par 16 GU10 de LED o CFL.

Pg 106

Pg 108

Pg 109

Pg 110



MORA **NEW**

Luminaria de carril para lámpara **LED PAR16**.
Conexión directa a 230V.

Múltiples opciones gracias a la gran variedad de modelos existentes de lámpara **LED PAR16**.

230V	IP20	Class II	DIMABLE
BLANCO	NEGRO		

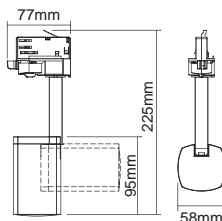

COD	REF. INT	MAX. W	LÁMPARA		COLOR		PVR
53662	FTK70317v0/WH	8W	PAR 16	GU10	○	SI	23,33 €
53679	FTK70317v0/BK	8W	PAR 16	GU10	●	SI	23,33 €

Se suministra sin lámpara.



LÁMPARA RECOMENDADA
PAR 16 GU10

La luminaria Mora puede montar cualquier lámpara Par 16 GU10 de LED o CFL.



Pg 106



Pg 108



Pg 109



Pg 110



Pg 182 - Soraa

LUMINARIAS LED SUSPENSIÓN



Gabio

67



Luster

68



Leo

70



GABIO  

Nueva generación de luminaria lineal de diseño vanguardista, que se adapta a cualquier iluminación de interiores.

Alto confort visual ideal para la iluminación en ambientes de trabajo.



Opciones de montaje para diferentes aplicaciones: montaje de superficie, suspensión y empotrado (con kit de accesorios adicional).

Sistema modular para conexión en serie lineal disponible bajo petición.

Aplicaciones: Oficinas, despachos, escuelas, almacenes y comercios.

IP20
UGR ≤19
Class I
GRIS
 CONFORT VISUAL
HASTA 117 Lm/W

 90°
 1140x56x55
 50,000

CÓDIGO	REF. INT	W	V	TC	LM	CRI		MEDIDAS		PVR
52443	FLP70000v1	30W	230V	4000K	3500 lm	82	90°	1140x56x55	50.000h	100 €
54065	Kit de suspensión GABIO									30 €
55826	Unión lineal GABIO									4 €

Driver incluido, consultar la versión regulable 1-10V y DALI - Medidas dadas en milímetros



CAMPANA LUSTER

SUSPENSIÓN

50°C

50000hrs

LED módulo con disipador

ó

Reflector

ó

Tapa (opcional)

ó

Las parte son intercambiables, minimizando almacenamiento y transporte.

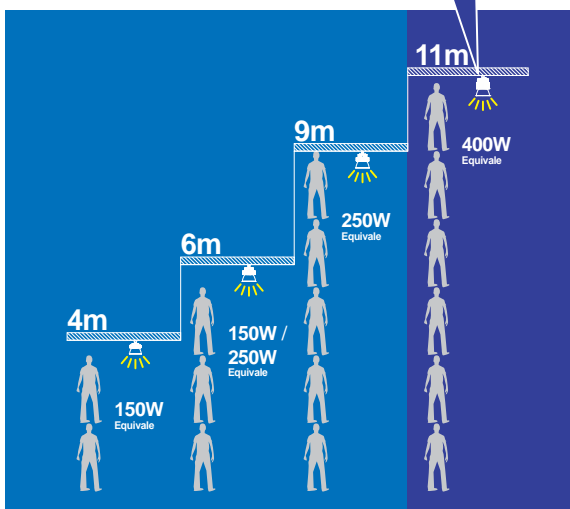

CAMPANA LUSTER

MEGAMAN® LUSTER LED tiene un LED integrado. Dispone de luz instantánea y de alta calidad que es ideal para su uso en grandes áreas internas y externas.

- Diseñado como alternativa a campanas con lámparas de descarga de 150W, 250W y 400W.
- Hasta 21000 Lm de salida.
- Eficacia de hasta 110 Lm x watio.
- La opción 21000 Lm se puede utilizar en 50°C temperatura ambiente (Ta 50°C) con tiempo de vida de 50000 horas (L70).
- Idóneo para aplicaciones extremas, como la parte superior del techo de una fábrica, techos altos, pasillos, almacenes, muelles de fabricación, ferias y exposiciones al aire libre.
- Los reflectores son intercambiables, lo que minimiza los costes de almacenamiento y transporte.
- El diseño del reflector es de tamaño compacto y ligero de peso, que permite una mayor iluminación.
- Importante reducción en el consumo de energía y costes de mantenimiento.

100
-240V

IP65

Class
I

COMFORT VISUAL ANTI-DESLUMBRAMIENTO

COD	REF. INT	W	TC	LM	△	CRI	ACABADO	↗	⊘	🕒	PVR
50548	LA3202+LA3130	65W	4000K	7200	60°	80	POLICARBONATO	335	318	50000h	233,33 €
50555	LA3202+LA3129	65W	4000K	7200	90°	80	ALUMINIO	275	240	50000h	233,33 €
50562	LA3203+LA3130	110W	4000K	11000	60°	80	POLICARBONATO	355	318	50000h	300 €
50579	LA3203+LA3129	110W	4000K	11000	90°	80	ALUMINIO	295	240	50000h	300 €
50586	LA3204+LA3130	210W	4000K	21000	60°	80	POLICARBONATO	415	318	50000h	383,33 €
50593	LA3204+LA3129	210W	4000K	21000	90°	80	ALUMINIO	355	240	50000h	383,33 €

Medidas dadas en milímetros

LEO

NEW

- Luminaria led de suspensión de diseño modular y ultrafino.
- Carcasa robusta de policarbonato para una alta resistencia al impacto y al exterior.
- Peso extremadamente ligero (3 kg) para facilitar el montaje, reduciendo costo de instalación y mano de obra
- El cableado sin herramientas permite una conexión rápida
- El disipador de calor oculto hace que el producto sea discreto y minimalista.



COD	REF. INT	W	TC	LM	UGR	△	CRI	☉	↗	🕒	PVR
-	FHB70000v0+110d	90W	4000K	11000	<22	110°	80	NO	416x196x114	50000h	180 €

Medidas dadas en milímetros. Producto bajo consulta.



COD	REF. INT	W	TC	LM	UGR	△	CRI	☉	↗	🕒	PVR
-	FHB70100v0+110d	180W	4000K	22000	<22	110°	80	NO	416x416x114	50000h	360 €

Medidas dadas en milímetros. Producto bajo consulta.

ACCESORIOS

COD	REF. INT	DESCRIPCIÓN
-	LA10081	KIT DE SUSPENSIÓN
-	LA10084	LIRA SUJECIÓN 90W
-	LA10089	LIRA SUJECIÓN 180W

Producto bajo consulta.





OUTDOOR LUMINARIAS DE EXTERIOR



En시오 74



Tott 76



Tott Economy 77



Cortona 78



Keppa 79



Advant 80



Fonda Redondo 81



Fonda Ovalado 81



Dino 1 82



Dino 2 83



Dino Farm 84



Mezo 85



Cappi 79

ENSIO

OUTDOOR | PROYECTOR



ENSIO



- Proyector LED de altas prestaciones para iluminación exterior.
- Hasta 22000 Lm de salida a 122 Lm por vatio sistema.
- Diseñado como una alternativa para sustitución de lámparas de descarga de 250W y 400W.
- Ahorro de más del 50% de energía en comparación proyectores con lámpara de descarga.
- LED de bajo deslumbramiento, luz simétrica y asimétrica.
- Larga vida útil de 50.000 horas (L70).
- Carcasa de aluminio fundido para la protección contra la corrosión.
- Peso ligero y delgado para permitir una fácil instalación.



Ensio 90W

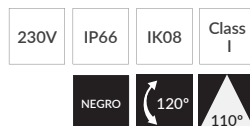
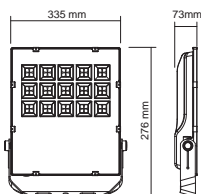

COD	REF. INT	W	TC	LM	CRI	☾	🕒	PVR
51651	FFL70000v0	90W	4000K	11000	80	NO	50000h	300 €



Ensio 180W

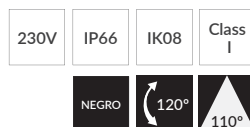
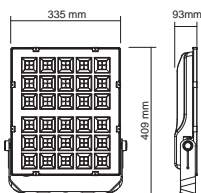

COD	REF. INT	W	TC	LM	CRI	☾	🕒	PVR
52825	FFL70100v0	180W	4000K	22000	80	NO	50000h	600 €



TOTT

Proyector led para iluminación interior y exterior. Ideal para sustituir los proyectores halógenos y bajas potencias en lámparas de descarga. Hasta 25.000 horas de vida ahorrando costes de energía y mantenimiento.

Construido en aluminio y es compacto y ligero. Innovador posicionamiento de la fuente de luz para evitar deslumbramiento semejante a la iluminación lineal de lámparas de cuarzo.

230V	IP65	Class I	GRIS	NEGRO
------	------	---------	------	-------

COD	REF. INT	W	TC	LM	COLOR	CRI	☾	🕒	PVR
★ 39093	F25400SM	33W	4000K	2300	●	80	NO	25000h	32 €

★ Últimas unidades

Tott S - 12W

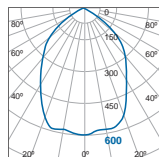
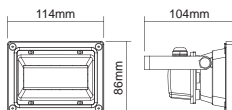

m	Lux	Ø cm
0.5	2400	84
1	600	165
1.5	267	252
2	150	336

Beam angle = 80°

Tott M - 33W

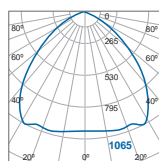
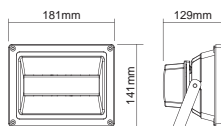

m	Lux	Ø cm
0.5	4260	119
1	1065	238
1.5	473	358
2	266	477

Beam angle = 100°



TOTT ECONOMY NEW

Proyector led para iluminación interior y exterior. Ideal para sustituir los proyectores halógenos y bajas potencias en lámparas de descarga. Hasta 25.000 horas de vida ahorrando costes de energía y mantenimiento.

220V 240V	IP65	Class I	NEGRO
--------------	------	------------	-------

COD	REF. INT	W	TC	LM	COLOR	CRI	☉	🕒	PVR
52405	FFL70300v0	9,5W	4000K	900	●	80	NO	25000h	19 €
52412	FFL70200v0	24W	4000K	2300	●	80	NO	25000h	32 €
52429	FFL70400v0	45W	4000K	4200	●	80	NO	25000h	45 €

Tott S - 9,5W

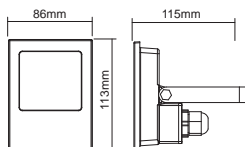

Tott M - 24W

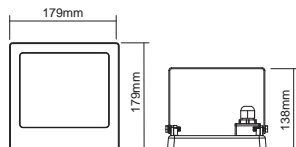

Tott L - 45W

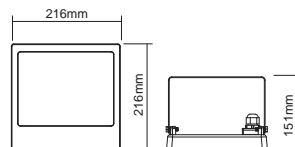



CORTONA

Zhaga

Proyector led integrado gracias al módulo **TECOH CFx** de **MEGAMAN®**.

Proyector sin fuente de alimentación.

Módulo intercambiable y de fácil instalación.

De diseño similar a los proyectores de exterior tradicionales.



COD	REF. INT	MAX. W	Tc	LÁMPARA	COLOR	CRI	☉	🕒	PVR
34050	F25845	30W	2800K	TECOH CFx	●	80	SI	25000h	60 €
34067	F25845	30W	4000K	TECOH CFx	●	80	SI	25000h	60 €

Se suministra con lámpara



Tecoh CFx

MODULOS LED

La luminaria CORTONA monta el módulo led **TECOH CFx**. Ver más características de las lámpara en página 88.

COD	W	V	TC	LM
33015	20W	230V	2800K	1100
33022	20W	230V	4000K	1200
33039	30W	230V	2800K	1800
33046	30W	230V	4000K	2000



KEPPA

Proyector para exterior donde poder incorporar lámpara LED de MEGAMAN®.

Ángulo de inclinación de hasta 330° para poder orientar la luz según se desee. Luminaria a prueba de corrosión.



LÁMPARA LED CLUSTERLITE

El proyector KEPPA funciona con la lámpara CLUSTERLITE de LED.
Ver CLUSTERLITE LED pag. 131.

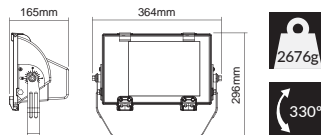

230V	IP65	IK03	Class II	GRIS
------	------	------	----------	------

COD	REF. INT	LÁMPARA	■	COLOR	CRI	⌚	PVR
★ 02318	F00601SM/AS	CLUSTERLITE	E27	●	80	25000h	50 €

Se suministra sin lámpara. ★ Últimas unidades



CAPPI

Pincho de jardín con índice de protección IP54 para uso en exteriores.



LÁMPARA LED
PAR 38
Ver en la página 103.

230V	IP54	IK03	Class II	NEGRO
------	------	------	----------	-------

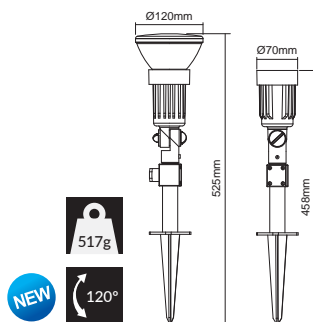

COD	REF. INT	LÁMPARA	■	COLOR	PVR
53525	F32114SP	PAR38	E27	●	14 €

Se suministra sin lámpara.



ADVANT

Proyector portátil multifunción para exteriores e interiores.
Como pincho de jardín, como proyector de fachada o suspensión.
Fácil de instalación y manejo.

230V	IP66	IK03	Class II	GRIS
------	------	------	----------	------

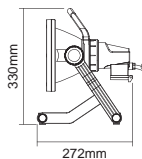

COD	REF. INT	W	TC	LM	COLOR	CRI	☾	🕒	PVR
36702	F27000PL	19W	4000K	1350	●	80	NO	25000h	65 €

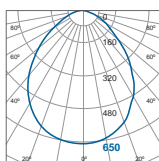

m	Lux	Ø cm
0.5	2600	100
1	650	200
1.5	289	300
2	163	400

Beam angle = 90°





FONDA CIRCULAR

Luminaria led decorativa integrada para su uso en exteriores e interiores. Como sustituto de plafones convencionales.

Gran ahorro en consumo de energía y durabilidad. Idóneo para comunidades, viviendas, exteriores, zonas comunes, etc...



COD	REF. INT	W	TC	LM	COLOR	CRI	☾	🕒	PVR
50609	F51100SM-WH	10,5W	3000K	800	○	80	NO	25000h	62 €
50616	F51100SM-WH	10,5W	4000K	800	○	80	NO	25000h	62 €
50623	F51100SM-SL	10,5W	3000K	800	●	80	NO	25000h	62 €
50630	F51100SM-SL	10,5W	4000K	800	●	80	NO	25000h	62 €
50647	F51100SM-BK	10,5W	3000K	800	●	80	NO	25000h	62 €
50654	F51100SM-BKv	10,5W	4000K	800	●	80	NO	25000h	62 €

Medidas dadas en milímetros



FONDA OVAL

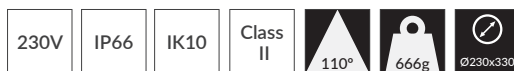

COD	REF. INT	W	TC	LM	COLOR	CRI	☾	🕒	PVR
50661	F51300SM-WH	10,5W	3000K	800	○	80	NO	25000h	62 €
50678	F51300SM-WH	10,5W	4000K	800	○	80	NO	25000h	62 €
50685	F51300SM-SL	10,5W	3000K	800	●	80	NO	25000h	62 €
50692	F51300SM-SL	10,5W	4000K	800	●	80	NO	25000h	62 €
50708	F51300SM-BK	10,5W	3000K	800	●	80	NO	25000h	62 €
50715	F51300SM-BK	10,5W	4000K	800	●	80	NO	25000h	62 €

Medidas dadas en milímetros

DINO 1

OUTDOOR | PANTALLA ESTANCA

MEGAMAN®



DINO 1

PANTALLA ESTANCA



230V

IP66

IK08

Class II

GRIS

Construido con un cuerpo de policarbonato resistente y difusor prismático opal, el **MEGAMAN® DINO** tiene protección IP66 contra agua y polvo y IK08 de resistencia al vandalismo y a los golpes. - una alternativa ideal a pantallas estancas T5 y T8.

MEGAMAN® DINO está diseñado para ser fácil de instalar, fácil de limpiar y mantener. Perfecta para su uso en aparcamientos, almacenes, talleres, áreas subterráneas y aplicaciones más industriales. 120° de distribución de la luz.

COD	REF. INT	W	TC	LM	CRI				PVR
43175	F50300SMv1	35W	4000K	3600	82	1600	NO	50000h	45€



Driver integrado. Medidas dadas en milímetros. Últimas unidades

Dino - 35W

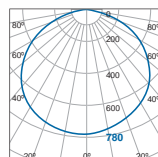
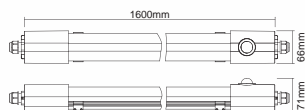

m	Lux	Ø cm
0.5	3120	173
1	780	346
1.5	347	520
2	195	693

Beam angle = 120°

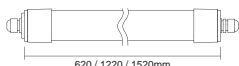
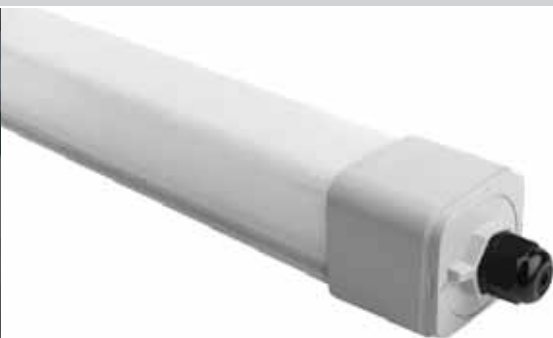

DINO 2



- Construido con un cuerpo de policarbonato resistente y difusor prismático opal, el **MEGAMAN® DINO** tiene protección IP66 contra agua y polvo y IK08 de resistencia al vandalismo y a los golpes. - una alternativa ideal a pantallas estancas T5 y T8.
- **MEGAMAN® DINO** está diseñado para ser fácil de instalar, fácil de limpiar y mantener.
- Perfecta para su uso en aparcamientos, almacenes, talleres, áreas subterráneas y aplicaciones más industriales.
- 120° de distribución de la luz.
- Gran variedad de modelos a elegir.
- Accesorio para ocultar los cables entre conexiones con otras pantallas DINO 2.

COD	REF. INT	W	TC	LM	CRI	↕	☉	🕒	PVR
47142	F61400SM	19,5W	4000K	1800	80	620	NO	50000h	51,67 €
47166	F61500SM	22,5W	4000K	2350	80	1220	NO	50000h	58,33 €
50722	F61600SM	35W	4000K	3600	80	1520	NO	50000h	83,33 €
47180	F61500SMv1	41,5W	4000K	4300	80	1220	NO	50000h	83,33 €
47227	F61600SMv1	63W	4000K	6500	80	1520	NO	50000h	116,67 €

Driver integrado. Medidas dadas en milímetros. Consultar la versión en 3.000K.



PIR Sensor Module

Diseñado con sistema modular, minimizando los costes de mantenimiento y energía.



PVR
35 €

Ref. int. LA 11076



Masters

Slave

Características del producto

- Detección hasta 8 m de distancia y 120° de cobertura.



DINO FARM

PANTALLA ESTANCA



230V

IP66

IK03

Class II

GRIS

Construido con un cuerpo de policarbonato resistente y difusor prismático opal, el **MEGAMAN® DINO FARM** tiene protección IP66 contra agua y polvo y IK08 de resistencia al vandalismo y a los golpes. - una alternativa ideal a pantallas estancas T5 y T8.

Megaman Dino Farm es ideal para su uso en la cría intensiva de animales, tales como cuadras y establos donde los niveles de resistencia a los gases agresivos que contienen amoníaco deterioran las luminarias.



COD	REF. INT	W	TC	LM	CRI				PVR
-	FOB70800v1	35W	4000K	4300	80	1220	NO	50000h	83,33 €
-	FOB70900v1	53W	4000K	6500	80	1572	NO	50000h	116 €

Driver integrado. Medidas dadas en milímetros. Producto bajo consulta

MEZO **NEW**

- Luminaria estanca con led integrado peso y diseño ultra fino.
- Luminaria con buena relación calidad-precio para múltiples aplicaciones.
- Las grapas de acero inoxidable se deslizan por la parte trasera de la luminaria, ofreciendo una instalación rápida y cómoda.
- La instalación permite entradas de cable flexibles.
- Protección IP66 contra el agua y el polvo, e IK08 para resistencia al vandalismo.
- Alta eficacia luminosa de hasta 106lm / W que ofrece un importante ahorro de energía de hasta 69% en comparación con los tradicionales fluorescentes T8.

35,000
hrsUp to
116
lm/W**IK08****IP66**Fácil
Instalación**120°**

COD	REF. INT	W	TC	LM	CRI				PVR
53686	FOB71100v0	35W	4000K	4000	80	1170	NO	35000h	46 €
53693	FOB71200v0	43W	4000K	5000	80	1470	NO	35000h	56 €

Driver integrado. Medidas dadas en milímetros



LÁMPARAS LED PROFESIONAL, SMART, ECONOMY Y BASIC SERIES



Módulos Tecoh 88



AR111



Hybrid Colour 94



Perfect White 98



Dual beam 96



Par 101



Reflectoras 115



Dicróica



Vela



Ping Pong 118



Esféricas 119



Globo 120



Night Light 120



Estándar



Cúpula



Liliput



T-Lamp 126



Bi-pin 127



Lineal 128



Sellite



Tubos



Clusterlite 131



Vintage Golden 133



Incanda 134



Módulo CFx

Tecoh



Genoa - Pg 26



Cortona - Pg 78

Zhaga

230V

142g

PHJ65

70 mm

42 mm

DIMABLE

COD	REF. INT	W	TC	LM	CRI	●	↗	⊘	SERIE	⌚	PVR
33015	CF0112d	20W	2800K	1100	82	SI	70	41	PS	25000h	54,17 €
33022	CF0112d	20W	4000K	1200	85	SI	70	41	PS	25000h	54,17 €
33039	CF0120d	30W	2800K	1800	82	SI	70	41	PS	25000h	62,50 €
33046	CF0120d	30W	4000K	2000	85	SI	70	41	PS	25000h	62,50 €

* Las medidas dadas son en milímetros



Módulo MHx

Tecoh



Modena - Pg 59

Zhaga

DC36V

62 mm

34 mm

DIMABLE

COD	REF. INT	W	TC	LM	CRI	●	↗	⊘	SERIE	⌚	PVR
35330	MH0130+LB2601	24W	3000K	2700	82	SI	62	34	PS	50000h	83,33 €
35354	MH0130+LB2601	24W	4000K	3000	85	SI	62	34	PS	50000h	83,33 €
38652	LD0424x1v-C700	24W	DRIVER	-	-	-	123x35	-	-	50000h	33,33 €

* Las medidas dadas son en milímetros. Producto bajo consulta



Módulo THx Tecoh - Ø111

NEW



Zekki 111 - Pg 38



COD	REF. INT	W	TC	LM	△	CRI	●	↗	⊘	SERIE	⌚	PVR
46954	TH0532-24D	32W	3000K	3200	24°	80	NO	92	111	PS	50000h	89 €
46985	TH0532-24D	32W	4000K	3200	24°	80	NO	92	111	PS	50000h	89 €
46961	TH0532-45D	32W	3000K	3200	45°	80	NO	92	111	PS	50000h	89 €
46992	TH0532-45D	32W	4000K	3200	45°	80	NO	92	111	PS	50000h	89 €
46978	TH0532-60D	32W	3000K	3200	60°	80	NO	92	111	PS	50000h	89 €
47005	TH0532-60D	32W	4000K	3200	60°	80	NO	92	111	PS	50000h	89 €

* Las medidas dadas son en milímetros. Driver incluido. Opcional versión DALI y 1-10V



Módulo THx Tecoh - Ø50

NEW



NEW

HoneyComb
PVR 6€



Zekki 50 - Pg 39



COD	REF. INT	W	TC	LM	△	CRI	●	↗	⊘	SERIE	⌚	PVR
47050	TH0309/828-24D	10,5W	2800K	900	24°	80	NO	75	50	PS	25000h	29 €
47067	TH0309/840-24D	10,5W	4000K	900	24°	80	NO	75	50	PS	25000h	29 €
47074	TH0309/828-36D	10,5W	2800K	900	36°	80	NO	75	50	PS	25000h	29 €
47081	TH0309/840-36D	10,5W	4000K	900	36°	80	NO	75	50	PS	25000h	29 €
47012	TH0205d/828-24D	8W	2800K	500	24°	80	SI	55	50	PS	25000h	16,67 €
47029	TH0205d/840-24D	8W	4000K	500	24°	80	SI	55	50	PS	25000h	16,67 €
47036	TH0205d/828-36D	8W	2800K	500	36°	80	SI	55	50	PS	25000h	16,67 €
47043	TH0205d/840-36D	8W	4000K	500	36°	80	SI	55	50	PS	25000h	16,67 €

* Las medidas dadas son en milímetros. No necesita driver

MEGAMAN®

SERIE AR111

Excelente intensidad lumínica para proporcionar el mejor rendimiento en la sustitución de una fuente de luz tradicional.

Excelente gama de lámparas LED AR111 de innovadora estética como sustituto perfecto de las lámparas halógenas, reflexión de la luz mejorando el rendimiento lumínico y el efecto deseado anti-deslumbramiento. Todas en versión regulable y disponibles en tres grados de apertura para potenciar el efecto acentuado de los objetos o espacios a iluminar.



AR111 GX 8.5



m	Lux	Ø cm
0.5	7900	21
1	4400	43
1.5	1956	64
2	1100	85

Beam angle = 24°

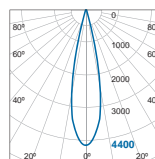

COD	REF. INT	W	TC	LM	△	CRI	☉	↗	⊘	SERIE	⌚	PVR
27229	ER0716-20M24D	16W	2800K	800	24°	85	SI	79	111	PS	40000h	30 €
27809	ER0716-20M24D	16W	4000K	800	24°	85	SI	79	111	PS	40000h	30 €
27243	LD0116x1v-C800	16W	DRIVER	-	-	-	-	147x50	-	-	-	19,17 €

* Las medidas dadas son en milímetros



AR111

LÁMPARAS LED

MEGAMAN®

AR111 G53 20V

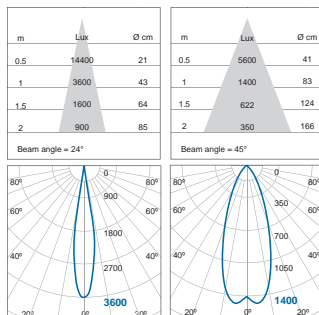

COD	REF. INT	W	TC	LM	△	CRI	☾	↗	⊘	SERIE	🕒	PVR
30045	ER0110-50H24D	10W	4000K	600	24°	85	SI	58	111	PS	40000h	30 €
30076	ER0310-50H45D	10W	2800K	600	45°	82	SI	58	111	PS	40000h	30 €
30083	ER0310-50H45D	10W	4000K	600	45°	85	SI	58	111	PS	40000h	30 €
29322	LD0310x1v-C500	10W	DRIVER	-	-	-	-	147x50	-	-	50000h	19,17 €

* Las medidas dadas son en milímetros

AR111 G53 12V

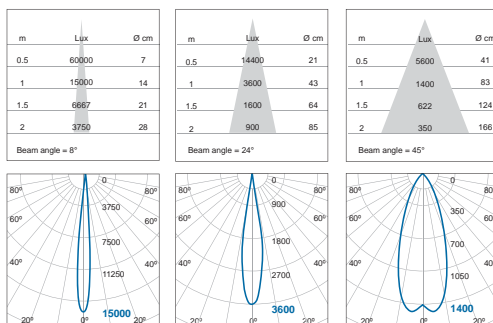
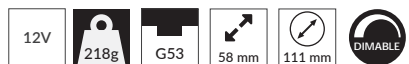

COD	REF. INT	W	TC	LM	△	CRI	☾	↗	⊘	SERIE	🕒	PVR
★ 30007	ER1211-50H08D	11W	4000K	530	8°	80	NO	58	111	PS	30000h	36 €
★ 36542	ER2011d-50H24D	11W	4000K	600	24°	80	SI	58	111	PS	30000h	36 €
★ 45667	ER2911d-50H45D	11W	4000K	630	45°	80	SI	58	111	PS	30000h	36 €

* Las medidas dadas son en milímetros - ★ Últimas unidades



m	Lux	Ø cm
0.5	68000	7
1	17000	14
1.5	7556	21
2	4250	28

Beam angle = 8°

m	Lux	Ø cm
0.5	20000	21
1	5000	43
1.5	2222	64
2	1250	85

Beam angle = 24°

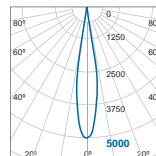
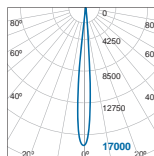

12V
275g
G53
62 mm
111 mm
DIMABLE

	COD	REF. INT	W	TC	LM	△	CRI	☉	↕	⊘	SERIE	🕒	PVR
★	34302	ER2115d-75H08D	15W	4000K	850	8°	80	SI	62	111	PS	30000h	45 €
★	45759	ER2712d-75H24D	12W	4000K	850	24°	80	SI	62	111	PS	30000h	45 €

* Las medidas dadas son en milímetros. - 🇪🇺 Últimas unidades



m	Lux	Ø cm
0.5	28000	21
1	7000	43
1.5	3111	64
2	1750	85

Beam angle = 24°

m	Lux	Ø cm
0.5	10000	41
1	2500	83
1.5	1111	124
2	625	166

Beam angle = 45°

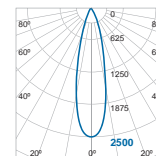
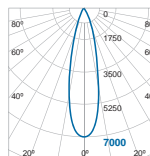

12V
275g
G53
62 mm
111 mm
DIMABLE

	COD	REF. INT	W	TC	LM	△	CRI	☉	↕	⊘	SERIE	🕒	PVR
★	43083	ER2016d-100H24D	16W	2800K	1300	24°	82	SI	62	111	PS	30000h	58,33 €
★	43090	ER2016d-100H24D	16W	4000K	1300	24°	85	SI	62	111	PS	30000h	58,33 €
★	43106	ER2216d-100H45D	16W	2800K	1300	45°	82	SI	62	111	PS	30000h	58,33 €

* Las medidas dadas son en milímetros. - 🇪🇺 Últimas unidades



MEGAMAN®

NEW

HYBRID COLOUR CRI95

VERDADERA REPRODUCCIÓN DE LOS COLORES

MEGAMAN® Hybrid Colour es la nueva serie diseñada para maximizar la riqueza y calidad de colores. Con una alta interpretación del color de hasta Ra95, **MEGAMAN® Hybrid Colour** es la sustitución perfecta para lámparas halógenas, halogenuros metálicos y led en aquellos usos donde la reproducción del color ha de ser fiel a la luz natural y de suma importancia para el sector retail, alimentación, galerías de arte, museos, etc...

MEGAMAN se convierte así en un fabricante top de soluciones de iluminación en este campo. **Hybrid Colour** maximiza la riqueza y la calidad de los colores en los espacios ó productos a iluminar. Reproducción cromática RA95 (**CRI95**) para interpretar fielmente los colores.

MEGAMAN arranca esta nueva serie con una de sus lámparas más famosas, **LED AR111** en 12V y **LED AR111 230V**





AR111 G53 12V



COD	REF. INT	W	TC	LM	△	CRI	↗	⊙	SERIE	🕒	PVR
51590	ER2812dR9HR-75H08D	12W	2800K	650	8°	95	58	111	PS	40000h	45 €
53334	ER2812dR9HR-75H08D	12W	4000K	650	8°	95	58	111	PS	40000h	45 €
51606	ER4013dR9HR-75H24D	13W	2800K	800	24°	95	58	111	PS	40000h	36 €
53341	ER4013dR9HR-75H24D	13W	4000K	800	24°	95	58	111	PS	40000h	36 €
51613	ER4013dR9HR-75H45D	13W	2800K	800	45°	95	58	111	PS	40000h	36 €
53358	ER4113dR9HR-75H45D	13W	4000K	800	45°	95	58	111	PS	40000h	36 €

* Las medidas dadas son en milímetros



AR111 GU10



COD	REF. INT	W	TC	LM	△	CRI	↗	⊙	SERIE	🕒	PVR
51620	LR6510dR9HR-75H08D	10W	2800K	650	8°	95	66	111	PS	40000h	52 €
53365	LR6510dR9HR-75H08D	10W	4000K	650	8°	95	66	111	PS	40000h	52 €
51637	LR6611dR9HR-75H24D	11W	2800K	800	24°	95	66	111	PS	40000h	47 €
53372	LR6611dR9HR-75H24D	11W	4000K	800	24°	95	66	111	PS	40000h	47 €
51644	LR6711dR9HR-75H45D	11W	2800K	800	45°	95	66	111	PS	40000h	47 €
53389	LR6711dR9HR-75H45D	11W	4000K	800	45°	95	66	111	PS	40000h	47 €

* Las medidas dadas son en milímetros

Life is colour



MEGAMAN®



**PULSA LA LENTE
Y CAMBIA EL HAZ DE LUZ**



AR111 DUAL BEAM

Presentamos las nuevas lámparas **LED AR111** de **MEGAMAN** cuya óptica te permite tener dos ángulos de luz según tus necesidades de iluminación. **DUAL BEAM TECHNOLOGY** de **MEGAMAN** es una nueva forma de iluminar gracias a su óptica y reflector Hybrid para maximizar y aprovechar el haz de luz evitando pérdidas de luz contaminantes innecesarias .

En dos tipos de formato 12V o 230V en temperatura de color como las lámparas halógenas de siempre y en versión regulable para ofrecer la luz que se desee en cada caso.





AR111 G53 12V



COD	REF. INT	W	TC	LM	△	CRI	SERIE	⌚	PVR
58162	ER205130/dm/db-HR-2B+024D/045D	13W	2800K	900	24°/45°	80	PS	40000h	45 €
-	ER205130/dm/db-HR-2B+024D/045D	13W	4000K	900	24°/45°	80	PS	40000h	45 €

* Las medidas dadas son en milímetros



AR111 GU10



COD	REF. INT	W	TC	LM	△	CRI	SERIE	⌚	PVR
58179	LR212110/dm/db-HR-2B+024D/045D	11W	2800K	900	24°/45°	80	PS	40000h	45 €
-	LR212110/dm/db-HR-2B+024D/045D	11W	4000K	900	24°/45°	80	PS	40000h	45 €

* Las medidas dadas son en milímetros

DBT



¿QUE ES EL DUAL BEAM TECHNOLOGY?

DBT (Dual Beam Technology), es la nueva óptica de Megaman que unido junto con el reflector te permite modificar el haz de luz de 24° a 45° y viceversa con solo pulsar la óptica de la luminaria . Sistema de Push and play.

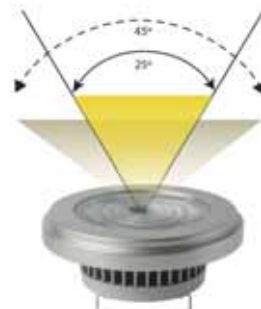



MEGAMAN®



PERFECT WHITE

ILUMINACIÓN PARA REALZAR EL COLOR BLANCO

La última innovación de **MEGAMAN** es una nueva tecnología **LED** llamada **Perfect White**, mejora los textiles, dando vida a los blancos y acentuando los colores. Ofreciendo excelente eficacia y alta eficiencia energética, **Perfect White** es ideal para todas las aplicaciones, pero realmente brilla en las instalaciones de **Retail**. La gama incluye **Downlight LED Vito**, **Downlight LED Carlo**, **Proyector de Carril LED Modena** y Lámpara **AR111**, todos diseñados para producir una luz vibrante que acentúa los objetos blancos, haciéndolos aparecer aún más blancos y brillantes.

Muchos textiles que se encuentran en tiendas, contienen Agentes Blanqueadores Fluorescentes (FWAs). Esta es la razón por la que la ropa a menudo se ve mejor cuando se muestra en la luz natural. **MEGAMAN Perfect White** tiene un revestimiento especial de fósforo que introduce la luz violeta con un pico a 410 nm en la parte visible, no perjudicial del espectro - también encontrado en la luz solar natural - para proporcionar una luz que imita el efecto de la luz natural sobre objetos blancos.

Además, el elemento violeta dentro de la tecnología **Perfect White** de **MEGAMAN**, deja el resto del espectro sin cambios - por lo que otros colores mantienen su vitalidad también. El violeta sólo afecta los FWAs, produciendo un acabado blanco puro.





AR111 G53 12V



COD	REF. INT	W	TC	LM	△	CRI	●	↕	○	SERIE	🕒	PVR
52757	ER2712p-75H24D	12W	3000K	700	24°	82	SI	58	111	PS	35000h	50 €
52764	ER2912p-75H45D	12W	3000K	700	45°	82	SI	58	111	PS	35000h	50 €

* Las medidas dadas son en milímetros



VITO EMPOTRABLE ORIENTABLE



COD	REF. INT	W	TC	LM	COLOR	CRI	△	●	🕒	PVR
-	F29349RC-p	45W	3000K	4100	○	82	35°	SI	50000h	200 €

Driver no incluido - Módulo incluido



CARLO EMPOTRABLE ORIENTABLE



COD	REF. INT	W	TC	LM	COLOR	CRI	△	●	🕒	PVR
-	F28249RC-p	34W	3000K	2400	○	82	35°	SI	50000h	200 €

Driver incluido - Módulo incluido

MEGAMAN®



DIM TO WARM

REGULACIÓN DE 2800K A 1800K

La tecnología MEGAMAN® Dim to Warm permite ofrecer un ambiente único y exclusivo

El modelo LED AR111 atenúa del 100% al 10% su temperatura de color, cambiando de 2800K a un cálido y acogedor 1800K que imita exactamente el color de la incandescencia, para crear un ambiente relajante y confortable.

MEGAMAN® es el primer fabricante de iluminación que ofrece una gama completa de lámparas LED de tipo "Dim to Warm", permitiendo tanto a los consumidores domésticos como a los profesionales de la iluminación replicar las características de las lámparas incandescentes y halógenas en sus instalaciones ofreciendo el mismo nivel de rendimiento de iluminación y perfil compacto Como los equivalentes tradicionales. El usuario también se beneficiará de todas las características de vanguardia que esperan de un MEGAMAN® LED en toda la gama, incluyendo un ahorro de energía significativo de hasta 80%, una vida útil más larga de hasta 35.000 horas, mantenimiento de alto lúmenes y por lo tanto menores costes de mantenimiento En comparación con la iluminación tradicional.



AR111 G53

36V

230g

G53

58 mm

111 mm

DIMABLE

DRIVER - AR111
Lumotech



0-10V
COD 52351 25,85 €

DALI
COD 52597 30 €

COD	REF. INT	W	TC	LM	∠	CRI	☉	↕	⊘	SERIE	🕒	PVR
51538	ER3712w-75H24D	12W	1800K	850	24°	82	SI	58	111	PS	40000h	50 €
51545	ER3712w-75H45D	12W	1800K	850	45°	82	SI	58	111	PS	40000h	50 €

* Las medidas dadas son en milímetros



SERIE PAR





PAR 20

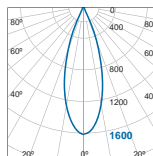
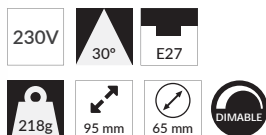

m	Lux	Ø cm
0.5	6400	27
1	1600	54
1.5	711	80
2	400	107

Beam angle = 30°

COD	REF. INT	W	TC	LM	⚠	CRI	☾	↕	⊘	SERIE	🕒	PVR
★ 23009	LR0308s-50H30D	8W	4000K	480	30°	82	SI/4P	95	65	PS	25000h	25 €

* Las medidas dadas son en milímetros - 📏 Últimas unidades



PAR 30S

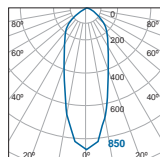

m	Lux	Ø cm
0.5	3400	32
1	850	63
1.5	378	95
2	213	126

Beam angle = 30°

COD	REF. INT	W	TC	LM	⚠	CRI	☾	↕	⊘	SERIE	🕒	PVR
41621	LR3010.5WFL	10,5W	2800K	700	30°	80	NO	88	95	EC	15000h	18 €
41638	LR3010.5WFL	10,5W	4000K	700	30°	80	NO	88	95	EC	15000h	18 €

* Las medidas dadas son en milímetros



PAR 30L CDM

Sustituto Halogenuro Metálico

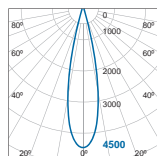
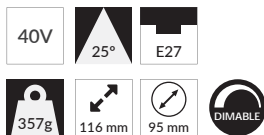

m	Lux	Ø cm
0.5	18000	22
1	4500	44
1.5	2000	67
2	1125	89

Beam angle = 25°

COD	REF. INT	W	TC	LM	⚠	CRI	☾	↕	⊘	SERIE	🕒	PVR
28660	ER0815-20M25D	15W	4000K	860	25°	80	SI	116	95	PS	40000h	40 €
24198	LD0115x1v - C380	15W	DRIVER	-	-	-	-	147x50	-	-	50000h	15 €

* Las medidas dadas son en milímetros



PAR 38

230V	E27	485g	133 mm	121 mm
------	-----	------	--------	--------

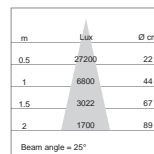
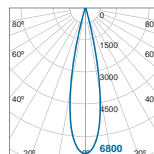
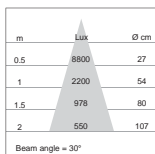
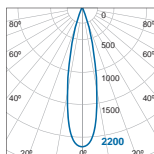

COD	REF. INT	W	TC	LM	∠	CRI	☉	↗	⊙	SERIE	🕒	PVR
★ 22699	LR0915-75H30D	15W	4000K	630	30°	85	NO	133	121	PS	30000h	40 €
★ 26833	LR0920-25M25D	20W	4000K	1200	25°	85	NO	133	121	PS	30000h	55 €

* Las medidas dadas son en milímetros - 🇪🇺 Últimas unidades



230V	35°	E27	204g	IP55 IP54
------	-----	-----	------	--------------

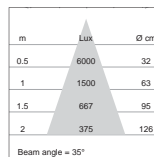
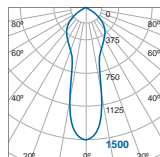

COD	REF. INT	W	TC	LM	∠	CRI	☉	↗	⊙	SERIE	🕒	PVR
41645	LR3215.5WFL	15,5W	2800K	950	35°	80	NO	132	121	EC	15000h	19 €
41652	LR3215.5WFL	15,5W	4000K	950	35°	80	NO	132	121	EC	15000h	19 €
NEW 53648	LR032130-GN	13W	●	-	35°	-	NO	132	121	EC 🌿	15000h	19 €
NEW 53655	LR032120/PT	12W	●	-	35°	-	NO	132	121	EC 🌿	25000h	23 €

* Las medidas dadas son en milímetros

LED Plant Lamp

NEW

Soluciones de iluminación eficientes para horticultura

- Ayuda a realizar la fotosíntesis para favorecer el crecimiento de la planta
- Utiliza un espectro de luz idóneo para el desarrollo (crecimiento y floración)
- Aporte de luz en ausencia de luz diurna.
- Tecnología led con bajo consumo energético.
- Invernaderos, centros de jardinería, hogar, comercio etc....

25.000
horas

Up to
29
umol/s



COD	REF. INT	MODELO	W	IP	PHOTON FLUX						PVR
53853	LG072085/PT	STANDAR	8,5W	IP20	17,5 umol/s	330°	NO	112	60	25000h	15 €
53655	LR032120/PT	PAR38	12W	IP55	29 umol/s	35°	NO	132	121	25000h	23 €

* Las medidas dadas son en milímetros



SERIE PAR16



PAR16

LÁMPARAS LED

MEGAMAN®

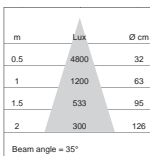
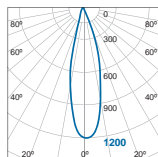
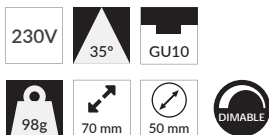

COD	REF. INT	W	TC	LM	△	CRI	☾	↕	↻	SERIE	🕒	PVR
★ 34463	LR2008d-50H35D	8W	4000K	480	35°	85	SI	70	50	PS	25000h	15 €

* Las medidas dadas son en milímetros - 📏 Últimas unidades



NEW

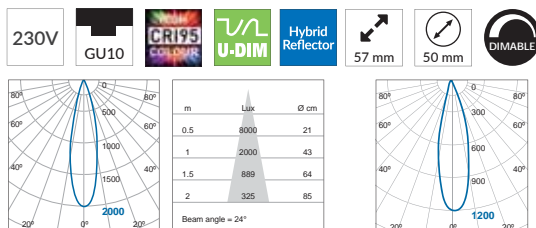

COD	REF. INT	W	TC	LM	△	CRI	☾	↕	↻	SERIE	🕒	PVR
53051	LR5906dHR-75H24D	6W	2800K	550	24°	82	SI	57	50	PS	25000h	18 €
53068	LR5906dHR-75H24D	6W	4000K	550	24°	82	SI	57	50	PS	25000h	18 €
53075	LR5906dHR-75H35D	6W	2800K	550	36°	82	SI	57	50	PS	25000h	18 €
53082	LR5906dHR-75H35D	6W	4000K	550	36°	82	SI	57	50	PS	25000h	18 €
53112	LR5906dR9HR-75H24D	6W	2800K	460	24°	95	SI	57	50	PS	25000h	23,33 €
53105	LR5906dR9HR-75H35D	6W	2800K	460	35°	95	SI	57	50	PS	25000h	23,33 €

* Las medidas dadas son en milímetros



PAR16 INGENIUM-BLU

LA FORMA MAS INTELIGENTE Y FÁCIL DE ILUMINAR TU ESPACIO

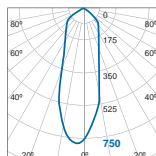

m	Lux	Ø cm
0.5	3000	32
1	750	63
1.5	333	95
2	188	126

Beam angle = 35°

COD	REF. INT	W	TC	LM	△	CRI	☾	↗	⊘	SERIE	🕒	PVR
44875	LR3808dbt	8W	2800K	540	35°	82	SI	65	50	SM	25000h	41,67 €

* Las medidas dadas son en milímetros



Fácil instalación

Puede instalarse sin necesidad de cableado, por lo que es accesible y rentable para todo el mundo



Control desde cualquier lugar

Controlar las lámparas MEGAMAN® LED desde el Smartphone o Tablet



Ahorro de energía

Ahorro de energía más altos cuando se utiliza la función de regulación



Ajuste de escena

Escenas de iluminación establecidos que se adaptan a todos los gustos



PAR16

LÁMPARAS LED

MEGAMAN®



COD	REF. INT	W	TC	LM	△	CRI	●	↔	⊙	SERIE	🕒	PVR
53761	LR206065/dm	6,5W	2800K	500	12°	80	SI	56	50	SM	25000h	21 €

* Las medidas dadas son en milímetros



COD	REF. INT	W	TC	LM	△	CRI	●	↔	⊙	SERIE	🕒	PVR
46237	LR4605.5 dDGWF	5,5W	2800K	500	38°	80	SI	57	50	SM	25000h	12 €
46244	LR4605.5 dDGWF	5,5W	4000K	500	38°	80	SI	57	50	SM	25000h	12 €
51422	LR4605.5 dvDGVWF	5,5W	2800K	500	60°	80	SI	57	50	SM	25000h	12 €
51439	LR4605.5 dvDGVWF	5,5W	4000K	500	60°	80	SI	57	50	SM	25000h	12 €
51552	LR5006wDG-WFL	6W	2800K 1800K	380	35°	80	SI	57	50	SM DM	25000h	17,50 €

* Las medidas dadas son en milímetros

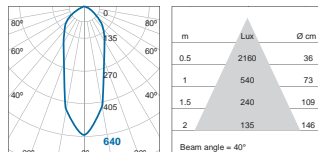

COD	REF. INT	W	TC	LM	∠	CRI	☾	↗	⊘	SERIE	🕒	PVR
46312	LR4605DGv2-WFL	5W	2800K	500	35°	80	NO	57	50	EC	15000h	6 €
50814	LR4605DGv2-WFL	5W	4000K	500	35°	80	NO	57	50	EC	15000h	6 €
51743	LR4605DGv2-VWFL	5W	2800K	500	60°	80	NO	57	50	EC	15000h	6 €
51750	LR4605DGv2-VWFL	5W	4000K	500	60°	80	NO	57	50	EC	15000h	6 €

* Las medidas dadas son en milímetros

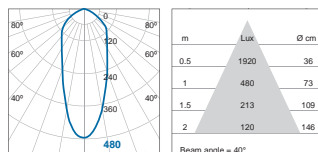
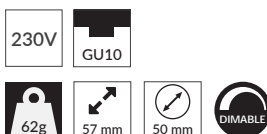

COD	REF. INT	W	TC	LM	∠	CRI	☾	↗	⊘	SERIE	🕒	PVR
50784	LR4605dDG-WFL	5W	2800K	360	38°	80	SI	57	50	EC	15000h	6 €
50791	LR4605dDG-WFL	5W	4000K	360	38°	80	SI	57	50	EC	15000h	6 €
★ 44219	LR4606dDG-WFL	6W	4000K	360	40°	80	SI	57	50	EC	15000h	6 €

* Las medidas dadas son en milímetros - 🇪🇺 Últimas unidades

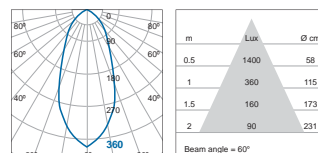
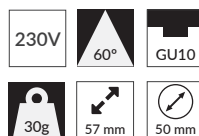

COD	REF. INT	W	TC	LM	∠	CRI	☾	↗	⊘	SERIE	🕒	PVR
46206	LR4604.5DG-VWFL	4,5W	2800K	360	60°	80	NO	57	50	EC	15000h	4 €
46213	LR4604.5DG-VWFL	4,5W	4000K	360	60°	80	NO	57	50	EC	15000h	4 €

* Las medidas dadas son en milímetros

PAR16

LÁMPARAS LED

MEGAMAN®

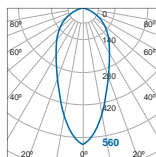

m	Lux	Ø cm
0.5	2240	32
1	560	63
1.5	249	95
2	140	126

Beam angle = 35°

COD	REF. INT	W	TC	LM	△	CRI	☾	↗	⊘	SERIE	🕒	PVR
45865	LR4604.5LN-WFL	4,5W	2800K	360	35°	80	NO	57	50	BS	15000h	4 €
45872	LR4604.5LN-WFL	4,5W	4000K	360	35°	80	NO	57	50	BS	15000h	4 €
51415	LR4604.5LN-WFL	4,5W	6500K	360	35°	80	NO	57	50	BS	15000h	4 €

* Las medidas dadas son en milímetros

NEW LÁMPARA LED PAR 16 DUAL BEAM



PULSA LALENTE
Y CAMBIA EL HAZ DE LUZ

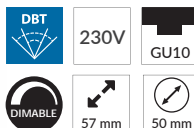

COD	REF. INT	W	TC	LM	△	CRI	☾	↗	⊘	SERIE	🕒	PVR
58223	LR211052/dm/db-HRv00-2B+024D/035D	5,2W	2800K	420	24°/36°	80	SI	57	50	SM	25000h	23,33 €

* Las medidas dadas son en milímetros

LÁMPARA LED PAR 16 CRISTAL GLAZE



COD	REF. INT	W	TC	LM	△	CRI	☾	↗	⊘	SERIE	🕒	PVR
51569	LR6305LN-WFL	5W	2800K	500	35°	80	NO	53,5	50	EC	15000h	6 €
51576	LR6305LN-WFL	5W	4000K	500	35°	80	NO	53,5	50	EC	15000h	6 €
51583	LR6305LN-WFL	5W	6000K	500	35°	80	NO	53,5	50	EC	15000h	6 €

* Las medidas dadas son en milímetros

MEGAMAN®



SERIE MR16



MR16

LÁMPARAS LED

MEGAMAN®



COD	REF. INT	W	TC	LM	∠	CRI	☾	↕	⊘	SERIE	🕒	PVR
★ 23931	ER0604-FL	4W	2800K	200	24°	82	NO	64	50	PS	30000h	6 €
★ 24303	ER0604-FL	4W	4000K	200	24°	82	NO	64	50	PS	30000h	6 €

* Las medidas dadas son en milímetros

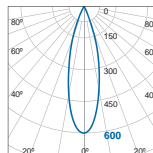

m	Lux	Ø cm
0.5	2400	32
1	600	65
1.5	267	97
2	150	130

Beam angle = 36°

COD	REF. INT	W	TC	LM	∠	CRI	☾	↕	⊘	SERIE	🕒	PVR
★ 28516	ER1006-35H36D	6W	4000K	240	36°	85	NO	51	50	PS	30000h	8 €

* Las medidas dadas son en milímetros

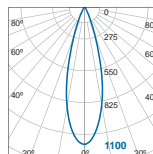
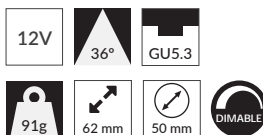

m	Lux	Ø cm
0.5	4400	32
1	1100	65
1.5	489	97
2	275	130

Beam angle = 36°

COD	REF. INT	W	TC	LM	∠	CRI	☾	↕	⊘	SERIE	🕒	PVR
★ 30144	ER1708d-50H36D	8W	4000K	430	36°	85	SI	62	50	PS	25000h	12 €

* Las medidas dadas son en milímetros. ★ Últimas unidades



12V
12°
GU5.3

60g
51 mm
50 mm

DIMABLE

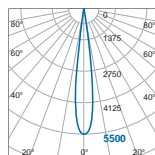

m	Lux	Ø cm
0.5	22000	11
1	5500	21
1.5	2444	32
2	1375	42

Beam angle = 12°

COD	REF	W	TC	LM	△	CRI	☾	↕	⊘	SERIE	🕒	PVR
46275	ER3308dLN-SP	8W	2800K	450	12°	82	SI	46	50	SM	25000h	20 €
50760	ER3308dLN-SP	8W	4000K	450	12°	82	SI	46	50	SM	25000h	20 €

* Las medidas dadas son en milímetros



12V
36°
GU5.3

43g
51 mm
50 mm

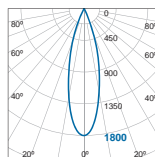

m	Lux	Ø cm
0.5	7200	32
1	1800	65
1.5	800	97
2	450	130

Beam angle = WFL36°

COD	REF	W	TC	LM	△	CRI	☾	↕	⊘	SERIE	🕒	PVR
38201	ER2607.5LN-WFL	7,5W	2800K	500	36°	82	NO	51	50	SM	25000h	17,50 €
38348	ER2607.5LN-WFL	7,5W	4000K	500	36°	85	NO	51	50	SM	25000h	17,50 €

* Las medidas dadas son en milímetros



12V
36°
GU5.3
HIGH LUMEN

60g
49 mm
50 mm

DIMABLE

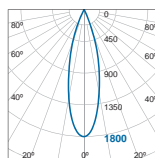

m	Lux	Ø cm
0.5	7200	32
1	1800	65
1.5	800	97
2	450	130

Beam angle = WFL36°

COD	REF	W	TC	LM	△	CRI	☾	↕	⊘	SERIE	🕒	PVR
51460	ER3308dDG-WF	8W	2800K	600	36°	82	SI	49	50	SM	25000h	19 €

* Las medidas dadas son en milímetros



12V
35°
GU5.3

28g
47 mm
50 mm

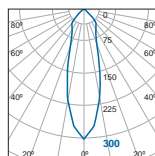

m	Lux	Ø cm
0.5	1200	58
1	300	115
1.5	133	173
2	75	231

Beam angle = 35°

COD	REF. INT	W	TC	LM	△	CRI	☾	↕	⊘	SERIE	🕒	PVR
46268	ER3406DG-VWFL	6W	2800K	400	36°	80	NO	47	50	EC	15000h	6 €
46688	ER3406DG-VWFL	6W	4000K	400	36°	80	NO	47	50	EC	15000h	6 €

* Las medidas dadas son en milímetros

MR11

LÁMPARAS LED

MEGAMAN®

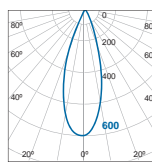

m	Ø cm
0.5	2400
1	600
1.5	267
2	150

Beam angle = 36°

COD	REF. INT	W	TC	LM	△	CRI	☉	↗	⊘	SERIE	⌚	PVR
33329	ER2304-20H36D	4W	2800K	230	36°	80	NO	42	35	SM	25000h	10 €
33336	ER2304-20H36D	4W	4000K	230	36°	80	NO	42	35	SM	25000h	10 €

* Las medidas dadas son en milímetros



R63

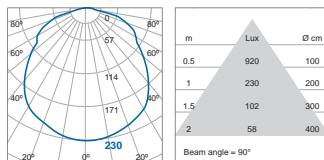
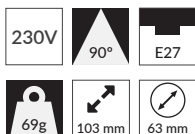

COD	REF. INT	W	TC	LM	△	CRI	☾	↗	⊙	SERIE	🕒	PVR
36665	LR2407.5	7,5W	2800K	600	90°	80	NO	103	63	Ec	15000h	12 €
36672	LR2407.5	7,5W	4000K	600	90°	80	NO	103	63	Ec	15000h	12 €

* Las medidas dadas son en milímetros



R80

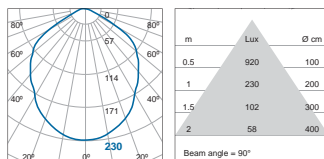
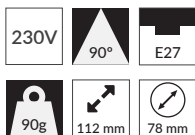

COD	REF. INT	W	TC	LM	△	CRI	☾	↗	⊙	SERIE	🕒	PVR
46183	LR4307	7W	2800K	520	90°	80	NO	112	78	Ec	15000h	12 €

* Las medidas dadas son en milímetros

MEGAMAN®



SERIE VELA





	COD	REF. INT	W	TC	LM	■	CRI	●	↗	○	SERIE	PVR
★	36498	LC0607dCSv2	7W	2800K	400	E14	80	SI	111	42	SM	6 €
★	36504	LC0607dCSv2	7W	4000K	400	E14	80	SI	111	42	SM	6 €

* Las medidas dadas son en milímetros - ★ Últimas unidades



	COD	REF. INT	W	TC	LM	■	CRI	●	↗	○	SERIE	PVR
★	33169	LC0607dv2	7W	2800K	400	E14	80	SI	111	42	SM	6 €
★	33176	LC0607dv2	7W	4000K	400	E14	80	SI	111	42	SM	6 €
★	33152	LC0607dv2	7W	4000K	400	E27	80	SI	111	42	SM	13,33 €

* Las medidas dadas son en milímetros - ★ Últimas unidades



	COD	REF. INT	W	TC	LM	■	CRI	●	↗	○	SERIE	PVR
	44226	LC1106dv3	6W	2800K	470	E14	80	SI	106	41	EC	6 €
	44233	LC1106dv3	6W	4000K	470	E14	80	SI	106	41	EC	6 €
	45575	LC1106dv3	6W	2800K	470	E27	80	SI	106	41	EC	13,33 €

* Las medidas dadas son en milímetros.



	COD	REF. INT	W	TC	LM	■	CRI	●	↗	○	SERIE	PVR
	45582	LC0405.5	5,5W	2800K	470	E14	80	NO	100	35	EC	4 €
	45599	LC0405.5	5,5W	4000K	470	E14	80	NO	100	35	EC	4 €
	45773	LC2405	5W	4000K	470	E14	80	NO	100	35	BS	4 €

* Las medidas dadas son en milímetros.

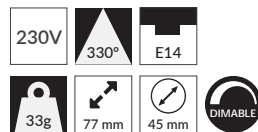
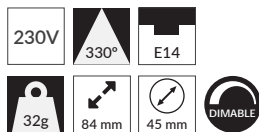

COD	REF. INT	W	TC	LM	■	CRI	●	↗	⌚	SERIE	🕒	PVR
33206	LG1405dv2	5W	2800K	270	E14	80	SI	84	45	SM	25000h	6 €
41966	LG2603.5	3,5W	2800K	250	E14	80	NO	84	45	EC	15000h	4 €
42741	LG2603.5	3,5W	4000K	250	E14	80	NO	84	45	EC	15000h	4 €

* Las medidas dadas son en milímetros.



230V	330°	30g	45 mm	15000h
------	------	-----	-------	--------

COD	REF. INT	W	TC	LM		CRI				SERIE	PVR
42406	LG5205.5	5,5W	2800K	470	E14	80	NO	84	45	EC	4 €
53310	LG5205.5	5,5W	4000K	470	E14	80	NO	84	45	EC	4 €
42413	LG2605.5	5,5W	2800K	470	E27	80	NO	77	45	EC	4 €
53327	LG2605.5	5,5W	4000K	470	E27	80	NO	77	45	EC	4 €
52771	LG2605dv2	5,5W	2800K	470	E14	80	SI	84	45	EC	6 €
52788	LG2605dv2	5,5W	2800K	470	E27	80	SI	77	45	EC	6 €

* Las medidas dadas son en milímetros.



230V	330°	30g	45 mm	15000h
------	------	-----	-------	--------

COD	REF. INT	W	TC	LM		CRI				SERIE	PVR
45797	LG9905	5W	4000K	470	E14	80	NO	84	45	BS	4 €

* Las medidas dadas son en milímetros.

MEGAMAN®



SERIE GLOBO



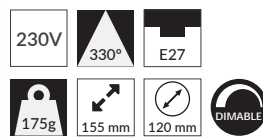
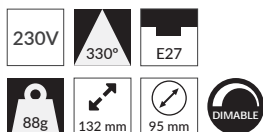

COD	REF. INT	W	TC	LM	■	CRI	●	↗	⊘	SERIE	🕒	PVR
46220	LG7610.5d	10,5W	2800K	810	E27	80	SI	132	95	SM	25000h	13 €
46664	LG7610.5d	10,5W	4000K	810	E27	80	SI	132	95	SM	25000h	13 €
51453	LG7611	11W	2800K	1055	E27	80	NO	132	95	EC	15000h	13 €
46190	LG7611	11W	4000K	1055	E27	80	NO	132	95	EC	15000h	13 €
42376	LG7713d	13W	2800K	1055	E27	80	SI	155	120	SM	25000h	33,33 €

* Las medidas dadas son en milímetros

NIGHT LIGHT

Ilumina cualquier lugar de tu casa durante las horas oscuras

Una sensación de seguridad y un remedio contra el miedo a la oscuridad. La serie MEGAMAN® NIGHT LIGHT LED ofrece una apariencia elegante que ilumina escaleras, pasillos y dormitorios.



COD	REF. INT	W	TC	↗	⊘	🕒	PVR
02004	NL050.2-AU	0,2W	●	57	41	20000h	5,83 €
02011	NL050.2-AU	0,2W	○	57	41	20000h	5,83 €

* Las medidas dadas son en milímetros

MEGAMAN®



SERIE ESTANDAR





230V 330° E27 25000h SM

COD	REF. INT	W	TC	LM	CRI	☉	↗	⊘	🛒	🕒	PVR
★ 33275	LG1708v2	8W	4000K	600	80	NO	-	-	-	25000h	5 €
NEW ✪ 53853	LG072085/PT	8,5W	-	-	-	NO	132	121	-	25000h	15 €

* Las medidas dadas son en milímetros y peso en gramos - ✪ Últimas unidades



230V 330° E27 15000h DIMABLE EC

COD	REF. INT	W	TC	LM	CRI	☉	↗	⊘	🛒	🕒	PVR
45643	LG7209.5	9,5W	2800K	810	80	NO	115	60	97	15000h	4 €
45650	LG7209.5	9,5W	4000K	810	80	NO	115	60	97	15000h	4 €
46657	LG7311	11W	2800K	1055	80	NO	117	60	67	15000h	5 €
45674	LG7311	11W	4000K	1055	80	NO	117	60	67	15000h	5 €
44196	LG6010.5d	10,5W	4000K	810	80	SI	110	60	110	15000h	5 €
52801	LG7209.5dv2	9,5W	2800K	810	80	SI	115	60	97	15000h	5 €
52818	LG7209.5dv2	9,5W	4000K	810	80	SI	115	60	97	15000h	5 €
45605	LG7414	14W	2800K	1521	80	NO	131	70	91	15000h	8 €
45612	LG7414	14W	4000K	1521	80	NO	131	70	91	15000h	8 €
46701	LG11514.5	14,5W	2800K	1921	80	NO	125	60	-	15000h	16 €
46718	LG11514.5	14,5W	4000K	1921	80	NO	125	60	-	15000h	16 €

* Las medidas dadas son en milímetros y peso en gramos



230V 330° E27 15000h BS

COD	REF. INT	W	TC	LM	CRI	☉	↗	⊘	🛒	🕒	PVR
45827	LG8607	7W	2800K	600	80	NO	107	60	47	15000h	3,50 €
45834	LG8607	7W	4000K	600	80	NO	107	60	47	15000h	3,50 €
★ 45841	LG8710	10W	2800K	810	80	NO	110	60	91	15000h	4 €
★ 45858	LG11310	10W	4000K	810	80	NO	110	60	91	15000h	4 €

* Las medidas dadas son en milímetros y peso en gramos - ✪ Últimas unidades



AC 12V 330° E27 25000h SM

COD	REF. INT	W	TC	LM	CRI	☉	↗	⊘	🛒	🕒	PVR
46725	LG2105.5	5,5W	2800K	450	80	NO	115	60	63	25000h	18,33 €

* Las medidas dadas son en milímetros y peso en gramos

CLASSIC 360° ESTANDAR

El nuevo led classic de MEGAMAN® ofrece una distribución uniforme de la luz con la iluminación de 360° para crear un ambiente confortable. Con su forma clásica, elegante y un rendimiento de iluminación general y aplicaciones de iluminación decorativa.



COD	REF. INT	W	TC	LM	■	CRI	●	↗	⊘	SERIE	⌚	PVR
52450	LG8008.5	8,5W	2800K	810	E27	80	NO	107	60	EC	15000h	17,90 €

* Las medidas dadas son en milímetros

Dim to WARM

1800K > 2700K

Con la tecnología Dim to WARM podrás atenuar la temperatura de color de 2700K a 1800K o lo que es lo mismo luz cálida a luz muy cálida sustituyendo lámpara halógenas e incandescentes.



COD	REF. INT	W	TC	LM	■	CRI	●	↗	⊘	SERIE	⌚	PVR
43045	LG2310.5W	10,5W	2700K	810	E27	80	SI	125	65	SM DIM	25000h	13,33 €

* Las medidas dadas son en milímetros

SENSOR LIGHT ESTANDAR

Lámpara de led con sensor de luz, la lámpara se encenderá al caer la noche y se apagará al amanecer automáticamente. Como medida disuasoria. Ideal para exteriores, hogares, fincas, hoteles, restaurantes, etc....



COD	REF. INT	W	TC	LM	■	CRI	●	↗	○	SERIE	🕒	PVR
46299	LG7206r	6W	2800K	600	E27	80	NO	115	60	SM	25000h	13 €
46695	LG2106r	6W	4000K	600	E27	80	NO	115	60	SM	25000h	13 €
33381	LG2108r	8W	2800K	600	E27	80	NO	115	60	SM	25000h	13 €

* Las medidas dadas son en milímetros

ingenium BLU ESTANDAR

Enciende, apaga y regula la luz de tu lámpara led con tu Smartphone sin necesidad de sobrecostos de instalación por conexión Bluetooth. Fácil de usar. Crea grupos de lámparas para obtener los efectos de luz deseados en cualquier espacio a iluminar.



COD	REF. INT	W	TC	LM	■	CRI	●	↗	○	SERIE	🕒	PVR
43052	LG2311dBT	11W	2800K	810	E27	80	SI	125	65	SM	25000h	28 €

* Las medidas dadas son en milímetros



CROWN

230V



COD	REF. INT	W	TC		COLOR	CRI				SERIE		PVR
35880	LS0205d	5W	2800K	E14	●	80	SI	84	45	SM	25000h	B/C
35897	LS0205d	5W	4000K	E14	●	80	SI	84	45	SM	25000h	19,17 €
35873	LS0505d	5W	2800K	E27	●	80	SI	106	60	SM	25000h	35 €
42673	LS0505d-Brass	5W	2800K	E27	●	80	SI	106	60	SM	25000h	35 €

* Las medidas dadas son en milímetros - B/C: bajo consulta



LILIPUT MINI

230V



COD	REF. INT	W	TC	Lm		CRI				SERIE	PVR
45629	LG8207	7W	2800K	600	E14	80	NO	101	40	EC	10 €
45636	LG8207	7W	2800K	600	E27	80	NO	101	40	EC	10 €

* Las medidas dadas son en milímetros



T-LAMP

(neveras, ilumina cuadros, etc)

230V



COD	REF. INT	W	TC	Lm		CRI				SERIE	PVR
53723	LG5502.2	2,2W	2800K	180	E14	80	NO	57	26	EC	5 €

* Las medidas dadas son en milímetros





G9 DIMABLE



COD	REF. INT	W	TC	Lm	☐	CRI	☉	↕	⊘	SERIE	PVR
34630	LU0303d	3W	2800K	180	GU9	80	SI	46	22	SM	10,83 €
36917	LU0303d	3W	4000K	180	GU9	80	SI	46	22	SM	10,83 €
53730	LU200035/dm	3W	2800K	300	GU9	80	SI	-	-	SM	10,83 €

* Las medidas dadas son en milímetros



G9



COD	REF. INT	W	TC	Lm	☐	CRI	☉	↕	⊘	SERIE	PVR
42420	LU0403	3W	2800K	220	GU9	80	NO	53	22	EC	6,5 €
53303	LU0903.5	3,5W	2800K	330	GU9	80	NO	53	18	EC	7 €

* Las medidas dadas son en milímetros



G4



COD	REF. INT	W	TC	Lm	☐	CRI	☉	↕	⊘	SERIE	PVR
33343	EU0102	2W	3000K	120	GU4	80	NO	45	16	SM	5 €

* Las medidas dadas son en milímetros - ✖ Últimas unidades



G4



COD	REF. INT	W	TC	Lm	☐	CRI	☉	↕	⊘	SERIE	PVR
45568	EU0301.2	1,2W	2800K	100	GU4	80	NO	30	9	EC	6 €

* Las medidas dadas son en milímetros

LINEAL R7s

LÁMPARAS LED

MEGAMAN®



220-240V



COD	REF. INT	W	TC	Lm	☐	CRI	☉	↕	⊘	SERIE	⌚	PVR
46251	LJ0409d	9W	2800K	810	R7s	80	SI	118	25	SM	25000h	11 €
46671	LJ0409d	9W	4000K	810	R7s	80	SI	118	25	SM	25000h	11 €

* Las medidas dadas son en milímetros



220-240V



220-240V



	COD	REF. INT	W	TC	Lm	☐	CRI	☉	↕	SERIE	⌚	PVR
★	35811	LJ0107	7W	2800K	450	R7s	80	NO	83 x 56 x 30	SM	25000h	5 €
★	35828	LJ0107	7W	4000K	450	R7s	80	NO	83 x 56 x 30	SM	25000h	5 €
★	33978	LJ0209	9W	2800K	600	R7s	80	NO	118 x 56 x 29	SM	25000h	5 €
★	33985	LJ0209	9W	4000K	600	R7s	80	NO	118 x 56 x 29	SM	25000h	5 €

* Las medidas dadas son en milímetros (Largo x Ancho x Alto) - ★ Últimas unidades



COD	REF. INT	W	TC	Lm			CRI				SERIE		PVR
39154	LR3307d	7W	2800K	480	GX53	120°	80	SI	32	75	SM	25000h	20 €
39161	LR2206	6W	4000K	480	GX53	120°	80	SI	32	75	SM	25000h	20 €

NEW

* Las medidas dadas son en milímetros



COD	REF. INT	W	TC	Lm			CRI				SERIE		PVR
34647	LR2205	5W	2800K	300	GX53	120°	80	NO	24	75	EC	15000h	12 €
34654	LR2205	5W	4000K	300	GX53	120°	80	NO	24	75	EC	15000h	12 €

* Las medidas dadas son en milímetros



TUBOS LED

Una alternativa ideal para sustituir tubos T8 Fluorescentes.

Gama de tubos led **fabricados en cristal y con un film protector para evitar rotura de cristales**, reemplazo directo de tubos fluorescentes. Ahorra en un 50% el consumo de energía instalando los tubos led MEGAMAN®. Conexión por un extremo. Se suministra con cebador para pantallas con reactancia magnética. Si se quiere evitar la reactancia electrónica se debe recablear la pantalla y hacer la conexión 230V por un extremo. Cobertura de luz 330° por lo que no es necesario que los casquillos sean giratorios. Hasta 40.000 horas de vida. Aplicaciones en garajes, comercios, industria, oficinas, hogar, etc.



CRISTAL

220-
240V

330°

G13

40000h

COD	REF. INT	W	TC	Lm			CRI			SERIE		PVR
41768	LT0409.5	9,5W	3000K	800	G13	330°	80	NO	600	EC	40000h	8 €
41775	LT0409.5	9,5W	4000K	880	G13	330°	80	NO	600	EC	40000h	8 €
45681	LT0409.5	9,5W	6500K	880	G13	330°	80	NO	600	EC	40000h	8 €
41782	LT0518	18W	3000K	1600	G13	330°	80	NO	1200	EC	40000h	12 €
41799	LT0518	18W	4000K	1750	G13	330°	80	NO	1200	EC	40000h	12 €
45698	LT0518	18W	6500K	1750	G13	330°	80	NO	1200	EC	40000h	12 €
41805	LT0622	22W	3000K	2000	G13	330°	80	NO	1500	EC	40000h	14 €
41812	LT0622	22W	4000K	2200	G13	330°	80	NO	1500	EC	40000h	14 €
45704	LT0622	22W	6500K	2200	G13	330°	80	NO	1500	EC	40000h	14 €

* Las medidas dadas son en milímetros. Se suministra con cebador



CLUSTERLITE LED by MEGAMAN®

Nueva gama de lámparas led de altas potencias y de excelentes prestaciones para espacios donde se necesite alta luminosidad. Fabricadas en reducidas dimensiones y con una cuidada estética. Hasta 5.000 lúmenes de salida para la versión en 33W. Sustituto ideal para lámparas de vapor mercurio, sodio, luz mezcla y bajo consumo. Para uso en interior y exterior (índice de protección IP20, recomendado su uso con luminarias con índice de protección IP54 o superior).

HASTA 152 Lm/W



COD	REF. INT	W	TC	Lm	☐	CRI	⦿	↗	⊘	SERIE	⌚	PVR
42352	LH0127	27W	2800K	2800	E27	80	NO	188	63	SM	25000h	68 €
42369	LH0127	27W	4000K	2800	E27	80	NO	188	63	SM	25000h	68 €
43069	LH0132	32W	4000K	4160	E27	80	NO	188	63	SM	25000h	80 €
NEW 46749	LH0133	33W	2800K	4800	E27	80	NO	188	63	SM	25000h	92 €
NEW 46756	LH0133	33W	4000K	5000	E27	80	NO	188	63	SM	25000h	92 €
NEW -	LH0246	46W	2800K	6700	E40	80	NO	238	63	SM	25000h	110 €
NEW 52467	LH0246	46W	4000K	7000	E40	80	NO	238	63	SM	25000h	110 €
NEW -	LH201080	80W	2800K	11500	E40	80	NO	265	63	SM	25000h	160 €
NEW 53396	LH201080	80W	4000K	12000	E40	80	NO	265	63	SM	25000h	160 €

* Las medidas dadas son en milímetros

VINTAGE SERIES

FILAMENT GOLDEN 2200K - DIMABLE

Iluminación confortable y decorativa con temperatura de color de 2200K y un consumo de 3W.

- Proporciona una iluminación cálida y armoniosa que crea un estado de bienestar en el ambiente.
- Diferentes tipos de lámparas Vela, Classic A75, Globo G95, G125 y Edison ST58 están disponibles para atender a diversas aplicaciones.
- Diseño exclusivo e innovador en COLOR dorado.
- 100% - 10% regulación lineal para todas las versiones.



VELA



CLASSIC



EDISON



GLOBOS



GLOBO L

SERIE FILAMENT GOLDEN
VINTAGE SERIES



COD	MODELO	REF. INT	W	TC	LM	■	CRI	●	↗	○	SERIE	⌚	PVR
46633	VELA	LC1403GD/TP	3W	2200K	210	E14	80	NO	118	35	EC	15000h	12 €
43120	CLASSIC	LG6303dGD	3W	2200K	210	E27	80	SI	156	75	SM	15000h	14 €
43151	EDISON	LG6603dGD	3W	2200K	210	E27	80	SI	152	58	SM	15000h	14 €
43137	GLOBO S	LG6403dGD	3W	2200K	210	E27	80	SI	159	95	SM	15000h	14 €
43144	GLOBO L	LG6503dGD	3W	2200K	210	E27	80	SI	196	125	SM	15000h	14 €

* Las medidas dadas son en milímetros



ACCESORIOS VINTAGE
CABLE DE COLORES

Cable textil de 1,5 metros de longitud. Hasta 8 colores a elegir.
Ver página 249.



VELA



ESFÉRICA



ESTÁNDAR



GLOBO

SERIE INCANDA



	COD	MODELO	REF. INT	W	TC	LM	■	CRI	●	↗	⊙	SERIE	⌚	PVR
★	41669	VELA	LC0805dCS	5W	2800K	400	E14	80	SI	104	35	SM	25000h	7 €
★	41676	VELA	LC0805dCS	5W	4000K	400	E14	80	SI	104	35	SM	25000h	7 €
★	41683	ESFÉRICA	LG4003.5dCS	3,5W	2800K	250	E14	80	SI	77	45	SM	25000h	7 €
★	41713	ESTÁNDAR	LG4106dCS	6W	4000K	470	E27	80	SI	104	55	SM	25000h	7 €
★	41720	GLOBO	LG4106Dcs	9,5W	2800K	810	E27	80	SI	148	98	SM	25000h	7 €

* Las medidas dadas son en milímetros - 🇪🇸 Últimas unidades



LÁMPARAS CFL



Dicroicas 136



Sellite 136



Lineal 136



AR111 136



Bi-pin 139



Reflector 137



Esférica 137



Estándar 137



Softone 137



Vela 138



Zenia 138



Clusterlite 138



Liliput 138



Inyectables 139



Inyectables
PLI 139



Dimables 139

DICROICAS



COD	REF. INT	W	V	TC	LM					PVR
03681	BR0707i	7W	230V	6500K	-	GU10	NO	15000h	Consultar	
03704	BR0709i	9W	230V	4000K	-	GU10	NO	15000h	Consultar	
03711	BR0709i	9W	230V	6500K	-	GU10	NO	15000h	Consultar	
03599	BR0711i	11W	230V	4000K	-	GU10	NO	15000h	Consultar	
03612	BR2114i	14W	230V	2700K	-	GU10	NO	15000h	Consultar	
03629	BR2114i	14W	230V	3000K	-	GU10	NO	15000h	Consultar	
03636	BR2114i	14W	230V	4000K	-	GU10	NO	15000h	Consultar	
22613	BR1609	9W	230V	4000K	-	GU10	NO	10000h	Consultar	
22620	BR2711	11W	230V	2700K	-	GU10	NO	10000h	Consultar	
22637	BR2711	11W	230V	4000K	-	GU10	NO	10000h	Consultar	
03728	BR0407	7W	230V	2700K	-	GU10	NO	8000h	Consultar	
03735	BR0407	7W	230V	4000K	-	GU10	NO	8000h	Consultar	
03742	BR0409	9W	230V	2700K	-	GU10	NO	8000h	Consultar	
03759	BR0409	9W	230V	4000K	-	GU10	NO	8000h	Consultar	



SELLITE



COD	REF. INT	W	V	TC	LM					PVR
03483	GX0109iRD	9W	230V	●	280	GX53	NO	15000h	Consultar	



LINEAL

COD	REF. INT	W	V	TC	LM					PVR
22552	4P424i	24W	230V	4000K	1519	R7s	NO	8000h	Consultar	



AR111



COD	REF. INT	W	V	TC	LM					PVR
03537	BR1511i	11W	230V	4000K	-	GU10	NO	15000h	Consultar	
03568	BR1511i	11W	230V	4000K	-	GX53	NO	15000h	Consultar	



REFLECTORAS



COD	REF. INT	MODELO	W	V	TC				PVR
00185	BR0909i	R50	9W	230V	2700K	E14	NO	15000h	Consultar
00192	BR0909i	R50	9W	230V	4000K	E14	NO	15000h	Consultar
00284	BR1215i	R80	15W	230V	2700K	E27	NO	15000h	Consultar
00291	BR1215i	R80	15W	230V	4000K	E27	NO	15000h	Consultar
00307	BR1015	R90	15W	230V	2700K	E27	NO	15000h	Consultar
00314	BR1015	R90	15W	230V	4000K	E27	NO	15000h	Consultar

ESFÉRICAS



COD	REF. INT	W	V	TC	LM				PVR
01687	GA607GN	7W	230V	●	-	E27	NO	10000h	Consultar

ESTÁNDAR



COD	REF. INT	W	V	TC	LM				PVR
00390	GSU111	11W	230V	2700K	570	E27	NO	10000h	Consultar
00406	GSU111	11W	230V	4000K	570	E27	NO	10000h	Consultar

SOFTONE



COD	REF. INT	W	V	TC	LM				PVR
01526	CT0107	7W	230V	2700K	-	E14	NO	12000h	Consultar
01519	CT0107	7W	230V	2700K	-	E27	NO	12000h	Consultar
01502	CT0109i	9W	230V	2700K	405	E27	NO	15000h	Consultar
01557	CT0311	11W	230V	2700K	570	E27	NO	12000h	Consultar
01458	CT0215i	15W	230V	2700K	810	E27	NO	15000h	Consultar
01601	CT0215	15W	230V	6500K	810	E27	NO	12000h	Consultar
01571	CT0318i	18W	230V	2700K	900	E27	NO	15000h	Consultar

VELA



COD	REF. INT	W	V	TC	LM				PVR
00550	CL707iCS/SE	7W	230V	4000K	286	E14	NO	15000h	Consultar
00574	CL409CS/SE	9W	230V	4000K	405	E14	NO	10000h	Consultar
22460	CL811i CSSE	11W	230V	2700K	531	E14	NO	10000h	Consultar
00482	CL407CS/TP	7W	230V	2700K	286	E14	NO	10000h	Consultar
00642	CL409CT/SE	9W	230V	6500K	405	E14	NO	10000h	Consultar

ZENIA



COD	REF. INT	W	V	TC	LM				PVR
01335	W1608	8W	230V	2700K	-	E27	NO	8000h	Consultar
22088	W1508	8W	230V	4000K	-	E14	NO	8000h	Consultar
01304	3U120	20W	230V	4000K	-	E27	NO	8000h	Consultar

CLUSTERLITE



COD	REF. INT	W	V	TC	LM				PVR
03001	HC01100i	100W	230V	2700K	6700	E40	NO	15.000 h	Consultar
29476	HC01100i	100W	230V	3000K	6700	E40	NO	15.000 h	Consultar
07092	CP010120	120W	230V	DRIVER					Consultar
03049	HC01200x	200W	230V	2700K	14400	E40	NO	15.000 h	Consultar
02981	CP010200	200W	230V	DRIVER					Consultar
03070	HC01320x	320W	230V	2700K	23000	E40	NO	15.000 h	Consultar
02998	CP010320	320W	230V	DRIVER					Consultar

LILIPUT



COD	REF. INT	MODELO	W	V	TC				PVR
01090	SLU111	LILIPUT	11W	230V	4000K	E14	NO	10000h	Consultar
01113	SLU114	LILIPUT	14W	230V	2700K	E14	NO	15000h	Consultar
01137	SLU114	LILIPUT	14W	230V	4000K	E27	NO	15000h	Consultar
00895	MU111i	PLUS	11W	230V	2700K	E14	NO	15000h	Consultar
00901	MU111i	PLUS	11W	230V	4000K	E14	NO	15000h	Consultar
01816	MU211	PLUS	11W	230V	6500K	E27	NO	12000h	Consultar
00949	MU115i	PLUS	15W	230V	2700K	E14	NO	15000h	Consultar



INYECTABLES

COD	REF. INT	W	TC	V	TC			PVR
02257	T1G2309	9W	230V	2700K	565	G23 2PIN	8000h	Consultar
02028	T1G2311	11W	230V	2700K	900	G23 2PIN	8000h	Consultar
02059	T4G24D113	13W	230V	3000K	900	G24d1 2PIN	8000h	Consultar
02066	T4G24Q113	13W	230V	3000K	900	G24q1 4PIN	8000h	Consultar
02134	T4G24D218	18W	230V	3000K	1200	G24d2 2PIN	8000h	Consultar
02127	T4G24Q218	18W	230V	2700K	1200	G24q2 4PIN	8000h	Consultar
02141	T4G24Q218	18W	230V	3000K	1200	G24q2 4PIN	8000h	Consultar
02172	T4G24Q218	18W	230V	6500K	1200	G24q2 4PIN	8000h	Consultar
02202	T4G24D326	26W	230V	3000K	1800	G24d3 2PIN	8000h	Consultar
02219	T4G24Q326	26W	230V	3000K	1800	G24q3 4PIN	8000h	Consultar



PLI INYECTABLES

COD	REF. INT	W	V	TC	LM			PVR
06927	4P311i	11W	230V	3000K	650	GY29.3	15000h	Consultar
06934	4P311i	11W	230V	4000K	650	GY29.3	15000h	Consultar



BI-PIN



COD	REF. INT	W	V	TC	LM				PVR
02929	4U107i	7W	230V	3000K	310	G9	NO	15000h	Consultar
02936	4U107i	7W	230V	4000K	310	G9	NO	15000h	Consultar



DIMABLES

COD	REF. INT	MODELO	W	V	TC				PVR
01861	BR1411s	PAR16	11W	230V	2700K	GU10	4 PASOS	10000h	Consultar
24310	BR1411s	PAR16	11W	230V	4000K	GU10	4 PASOS	10000h	Consultar
03247	BR1411d	PAR16	11W	230V	2700K	GU10	LINEAL	10000h	Consultar
01915	GSU111s	ESTÁNDAR	11W	230V	2700K	E27	4 PASOS	10000h	Consultar
01885	GK715s	ESTÁNDAR	15W	230V	3000K	E27	4 PASOS	10000h	Consultar
24327	CL809s	VELA	9W	230V	2700K	E27	4 PASOS	10000h	Consultar



MEGATRON®

MEGATRON® - LA MARCA DE MEGAMAN PARA ALUMBRADO DECORATIVO EXTERIOR.

Megatron es una marca de Megaman para el desarrollo y fabricación de luminarias led para uso exterior. Bajo las mismas exigencias de calidad y diseño que la marca Megaman, Megatron se estrena con una gama de luminarias de diseño

para un cliente que busca una cuidada estética y unas calidades altas para su uso a la intemperie.

La gama se amplía con los proyectores led de sensor de movimiento que se activan al paso de personas ó vehículos.

LUMINARIAS LED



Gorky

142



Cango

143



Número

144



Loka

145



Bulka

146



Ispot

147

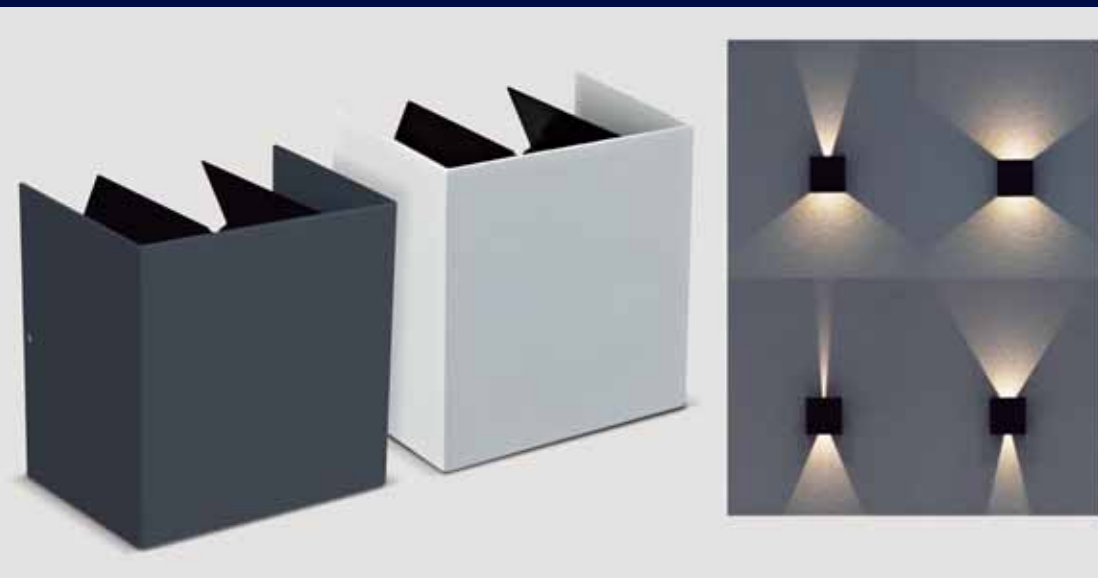

GORKY UP & DOWN DE PARED



MEGATRON® GORKY es un aplique led de pared, cuadrado, con cuerpo de aluminio, y con aletas para abrir o cerrar el haz de luz según se desee, lo que permite crear efectos exclusivos tanto en la parte superior como inferior. Conexión directa a 230V (driver interno incluido), IP54 y fácil de instalar.

COD	REF. INT	W	TC	LM	CRI	COLOR				PVR
55635	MT69000	6W	3000K	500	80	●	NO	140x145x105	30000h	70 €
55642	MT69011	6W	3000K	500	80	○	NO	140x145x105	30000h	70 €

* Las medidas dadas son en milímetros.



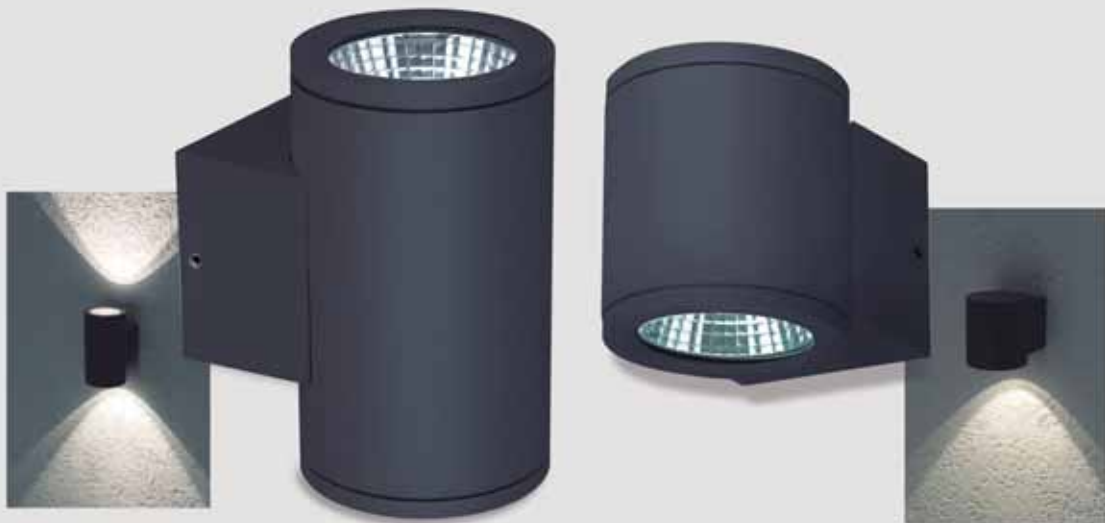

CANGO UP & DOWN
DE PARED



MEGATRON® CANGO en dos versiones disponibles. Luminaria led de pared de diseño compacto y de reducidas dimensiones, con fuente de luz con salida hacia abajo y con salida de luz hacia arriba y abajo. Modulo led COB con reflector de aluminio de 60° de apertura. Cuerpo de aluminio y cristal de protección para evitar la entrada de polvo, agua o insectos.

UP & DOWN

COD	REF. INT	W	TC	LM	CRI	COLOR				PVR
55666	MT69005	12W	3000K	1100	80	●	NO	106x80x138	30000h	90 €

* Las medidas dadas son en milímetros.

DOWN

COD	REF. INT	W	TC	LM	CRI	COLOR				PVR
55673	MT69006	6W	3000K	550	80	●	NO	106x80x95	30000h	60 €

* Las medidas dadas son en milímetros.

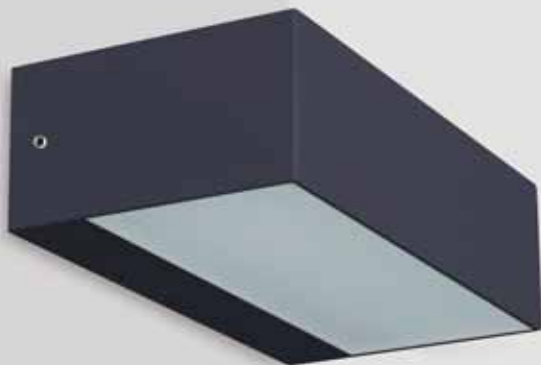

NUMERO UP & DOWN

DE PARED



MEGATRON® NUMERO es una luminaria led de pared, rectangular, con cuerpo en aluminio, y con efecto de luz arriba y abajo. Difusor acrílico para crear un efecto de luz confortable y difuminado.

COD	REF. INT	W	TC	LM	CRI	COLOR				PVR
55659	MT69002	10W	3000K	850	80	●	NO	207x110x60	30000h	77 €

* Las medidas dadas son en milímetros.



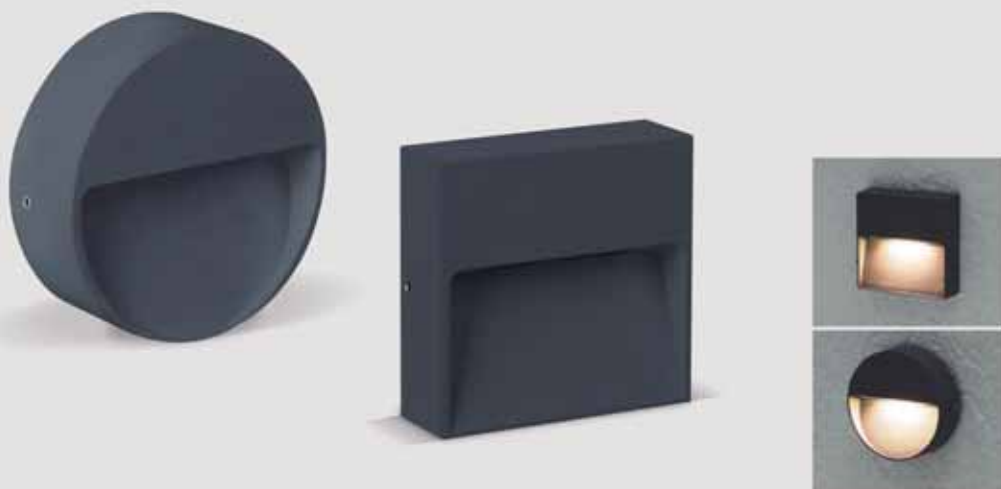

LOKA DE PARED



MEGATRON® LOKA LED es una luminaria led de pared, con cuerpo de aluminio y de reducidas dimensiones, diseñada para ofrecer una iluminación de señalización y un efecto anti deslumbramiento. Idóneo para iluminación de peldaños de escalera, pasillos, zonas de paso, etc... Crea un efecto decorativo y de vanguardia con su efecto cálido.

REDONDO

COD	REF. INT	W	TC	LM	CRI	COLOR				PVR
55680	MT69009	4,5W	3000K	300	80	●	NO	Ø100x30	30000h	50 €

* Las medidas dadas son en milímetros.

CUADRADO

COD	REF. INT	W	TC	LM	CRI	COLOR				PVR
55697	MT69010	4,5W	3000K	300	80	●	NO	100x100x30	30000h	50 €

* Las medidas dadas son en milímetros.

BULKA

LUMINARIAS OUTDOOR | DE PARED

MEGATRON®

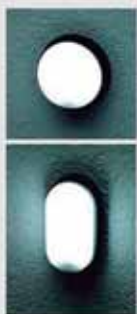

BULKA
DE PARED



MEGATRON® BULKA te permite tener una luminaria led de exterior ovalada o redonda equipada con sensor de movimiento PIR y fabricada en policarbonato. **El sensor dispone de un selector que permite modificar el tiempo** de conmutación desde 5 segundos hasta 8 minutos de duración, así como **el umbral de luminosidad para el encendido**. Iluminación uniforme con temperatura de color blanco neutro 4.000K.

REDONDO

COD	REF. INT	W	TC	LM	CRI	COLOR				PVR
55741	MT69040	10W	4000K	700	80	●	NO	Ø215x80	25000h	28 €

* Las medidas dadas son en milímetros.

OVALADO

COD	REF. INT	W	TC	LM	CRI	COLOR				PVR
55758	MT69041	10W	4000K	700	80	●	NO	212x119x60,5	25000h	28 €

* Las medidas dadas son en milímetros.



ISPOTS®
PROYECTOR



MEGATRON® ISPOTS®, gama de proyectores led de reducidas dimensiones, con cuerpo de aluminio y que incorporan sensor de movimiento PIR. Encendido automático cuando la persona se aproxima. **Posibilidad de modificar el tiempo de encendido, el umbral de luminosidad y sensibilidad del sensor.** Disponible en cuatro versiones de potencia y tamaños y con temperatura de color 4.000K.



ispots® S - 10W



ispots® M - 20W



ispots® L - 30W



ispots® XL - 50W

COD	REF. INT	W	TC	LM	CRI	COLOR	●	↗	⌚	PVR
55703	MT69030	10W	4000K	800	80	●	NO	150x130x55	25000h	26 €
55710	MT69031	20W	4000K	1600	80	●	NO	166x150x55	25000h	32 €
55727	MT69034	30W	4000K	2400	80	●	NO	207x190x61	25000h	47 €
55734	MT69035	50W	4000K	4000	80	●	NO	245x230x61	25000h	62 €

* Las medidas dadas son en milímetros.



Perox Lighting es un fabricante de luminarias LED. El diseño único de nuestros productos y servicios para crear una luz que aumenta el valor de su entorno, junto con las tecnologías necesarias para garantizar la óptima proyección de la iluminación. Un fabricante de iluminación LED líder en el segmento arquitectónico y comercial del mercado de la iluminación.

Iniciativas de conservación del medio ambiente son un foco central de nuestros objetivos, y que trabajan para desarrollar tecnologías y proporcionar conocimientos técnicos de iluminación que proporciona entornos de

iluminación de mayor valor con menos energía. Nos esforzamos no sólo para ayudar a las instalaciones arquitectónicas y comerciales aumentar el rendimiento luminotécnico y ahorrar costes energéticos.

Nuestros fabricados cumplen rigurosamente los controles de calidad, para ello en nuestras luminarias incorporamos componentes de primera calidad para garantizar el correcto funcionamiento de las mismas. El resultado final es un producto de diseño de vanguardia y de gran duración para un mercado exigente de especialistas de iluminación.

CHIP



DRIVER

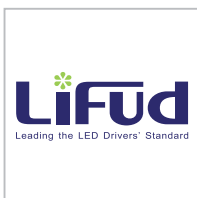



LUMINARIAS LED EMPOTRABLES FIJOS



Elux R 152



Elux SR 154



Mitec 157



Nexio 158



Hylux 159

EMPOTRABLES ORIENTABLES



Axtox 68 160



Garlux 161



Titlux 163

SUPERFICIE

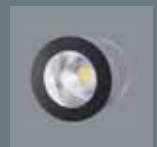

Canolux 165

ELUX R

LUMINARIAS | EMPOTRAR FIJO

PEROX LIGHTING
INNOVATIVE · EFFICIENT · HIGH-GRADE



ELUX R

EMPOTRAR FIJO

Elux R[®] es una nueva generación de LED con reflector de aluminio, diseñado para proyectos arquitectónicos y áreas comerciales. Una serie de productos pensados para sustituir el anticuado downlight halógeno.





Elux 68R



MOLDURA:	Aluminio fundido a presión y pintado a pistola	
ACABADO:	Blanco / Titán	
DISIPADOR DE CALOR:	Aluminio extrusionado y anodizado negro	
REFLECTOR:	Reflector de Plástico	
LED:	Sharp	
VOLTAJE:	220-240 V, 50-60Hz	
POTENCIA:	10W	
FLUJO LUMINOSO (Lm):	860.50 lm (500mA 10W 4000K)	ELX068RRS40
LA EFICIENCIA DEL SISTEMA (Lm / W):	98.54 lm/W (10W 4000K)	
CRI	4000K = CRI 83.20	
RANGO DE TEMPERATURA:	-20 °C a 36 °C	
HORAS DE VIDA:	40.000 horas a 25 °C	
TEMPERATURA DE COLOR:	○ 4000K	
DRIVER:	HEP	

COD	DRIVER	W	V	TC	LM	COLOR	▲	🕒	PVR
36177	HEP	10W	230V	4000K	860	○	36°	40000h	50 €
36979	HEP	10W	230V	4000K	860	●	36°	40000h	50 €



Elux 140R



MOLDURA:	Aluminio fundido a presión y pintado a pistola	
COLOR:	Blanco / Titán	
DISIPADOR DE CALOR:	Aluminio extrusionado y anodizado negro	
REFLECTOR:	Reflector de Aluminio	
LED:	Sharp	
VOLTAJE:	220-240 V, 50-60Hz	
POTENCIA:	26W	
FLUJO LUMINOSO (Lm):	2135 lm (500mA 26W 4300K)	ELX140RRS40-26
LA EFICIENCIA DEL SISTEMA (Lm / W):	81.54 lm/W (26W 4000K)	
CRI	4000K = CRI 83.70	
RANGO DE TEMPERATURA:	-20 °C a 36 °C	
HORAS DE VIDA:	40.000 horas a 25 °C	
TEMPERATURA DE COLOR:	○ 4000K	
DRIVER:	MEAN WELL	

COD	DRIVER	W	V	TC	LM	COLOR	▲	🕒	PVR
36214	MEAN WELL	26W	230V	4000K	2135	○	40°	40000h	100 €



ELUX SR

EMPOTRAR FIJO

Elux SR pertenece a la serie Elux. El Elux SR tiene una moldura antirreflejo. Con su aspecto cuadrado consigue crear otra opción en decoración para centros comerciales, oficinas, pasillos y áreas residenciales.



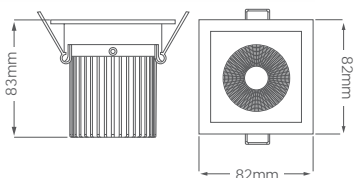

ELUX 68SR

68x68



MOLDURA:	Aluminio fundido a presión y pintado a pistola		
COLOR:	Blanco / Titán		
DISIPADOR DE CALOR:	Aluminio extrusionado y anodizado negro		
REFLECTOR:	Reflector de Plástico		
LED:	Sharp		
VOLTAJE:	220-240 V, 50-60Hz		
POTENCIA:	10W		
FLUJO LUMINOSO (Lm):	747.10 lm (500mA 10W 3000K)	ELX068SR530	
	860.50 lm (500mA 10W 4000K)	ELX068SR540	
LA EFICIENCIA DEL SISTEMA (Lm / W):	85.92 lm/W (10W 3000K)		
	98.54 lm/W (10W 4000K)		
CRI	3000K = CRI 83.40		
	4000K = CRI 83.20		
RANGO DE TEMPERATURA:	-20 °C a 36 °C		
HORAS DE VIDA:	40.000 horas a 25 °C		
TEMPERATURA DE COLOR:	● 3000K ○ 4000K		
DRIVER:	HEP		

COD	DRIVER	W	V	TC	LM	COLOR	▲	🕒	PVR
36108	HEP	10W	230V	3000K	747	○	36°	40000h	50 €
36115	HEP	10W	230V	4000K	860	○	36°	40000h	50 €

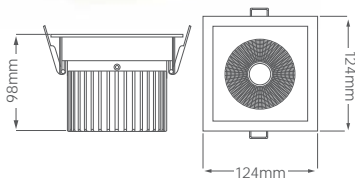

ELUX 110SR

110x110



MOLDURA:	Aluminio fundido a presión y pintado a pistola		
COLOR:	Blanco / Titán		
DISIPADOR DE CALOR:	Aluminio extrusionado y anodizado negro		
REFLECTOR:	Reflector de Aluminio		
LED:	Sharp		
VOLTAJE:	220-240 V, 50-60Hz		
POTENCIA:	19W		
FLUJO LUMINOSO (Lm):	1488 lm (500mA 19W 3000K)	ELX110SR530-19	
	1645 lm (500mA 19W 4000K)	ELX110SR540-19	
LA EFICIENCIA DEL SISTEMA (Lm / W):	79.98 lm/W (19W 3000K)		
	87.12 lm/W (19W 4000K)		
CRI	3000K = CRI 83.40		
	4000K = CRI 83.70		
RANGO DE TEMPERATURA:	-20 °C a 36 °C		
HORAS DE VIDA:	40.000 horas a 25 °C		
TEMPERATURA DE COLOR:	● 3000K ○ 4000K		
DRIVER:	MEAN WELL		

COD	DRIVER	W	V	TC	LM	COLOR	▲	🕒	PVR
36122	MEAN WELL	19W	230V	3000K	1488	○	46°	40000h	86,67 €
37129	MEAN WELL	19W	230V	3000K	1488	●	46°	40000h	86,67 €

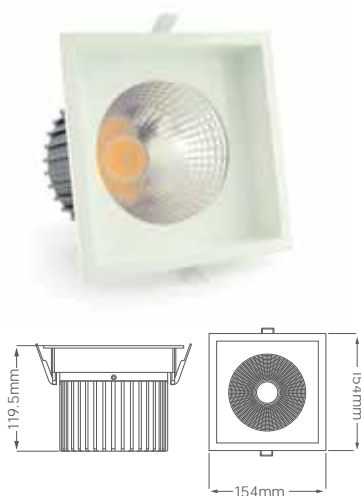

ELUX 140SR



MOLDURA:	Aluminio fundido a presión y pintado a pistola	
COLOR:	Blanco / Titán	
DISIPADOR DE CALOR:	Aluminio extrusionado y anodizado negro	
REFLECTOR:	Reflector de Aluminio	
LED:	Sharp	
VOLTAJE:	220-240 V, 50-60Hz	
POTENCIA:	26W	
FLUJO LUMINOSO (Lm):	2135 lm (500mA 26W 4300K)	ELX140SR540-26
LA EFICIENCIA DEL SISTEMA (Lm / W):	81.54 lm/W (26W 4000K)	
CRI	4000K = CRI 83.70	
RANGO DE TEMPERATURA:	-20 °C a 36 °C	
HORAS DE VIDA:	40.000 horas a 25 °C	
TEMPERATURA DE COLOR:	○ 4000K	
DRIVER:	MEAN WELL	

COD	DRIVER	W	V	TC	LM	COLOR	△	⌚	PVR
36153	MEAN WELL	26W	230V	4000K	2135	○	40°	40000h	106,67 €



Mitec R´ mini-foco alcanza un flujo luminoso excepcionalmente alto para su tamaño.



MITEC 50R

UGR ≤19	BLANCO	TITÁN	IP20	40,000
------------	--------	-------	------	--------

MOLDURA:	Aluminio mecanizado, Spray de pintura	
COLOR:	Blanco / Titán	
DISIPADOR DE CALOR:	Extrusión de Aluminio, anodizado negro	
ÁNGULO DEL HAZ:	30°	
REGULABLE:	Opcional Regulable o Sistema DALI	
LED:	Sharp	
VOLTAJE:	100-120 VAC o 220-240 VAC, 50-60Hz	
POTENCIA:	6W	
FLUJO LUMINOSO (LM):	392 lm (500mA 10W 3000K)	MIT050RRS30-6-30
	439 lm (500mA 10W 4000K)	MIT050RRS40-6-30
LA EFICIENCIA DEL SISTEMA (LM / W):	74.07 lm/W (10W 3000K)	
	83.42 lm/W (10W 4000K)	
CRI	CRI > 80	
RANGO DE TEMPERATURA:	-20 °C a 36 °C	
HORAS DE VIDA:	40.000 horas a 25 °C	
TEMPERATURA DE COLOR:	● 3000K ○ 4000K	
DRIVER:	HEP	

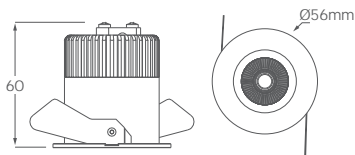

COD	DRIVER	W	V	TC	LM	COLOR	▲	🕒	PVR
39314	HEP	6W	230V	3000K	392	○	30°	40000h	37,50 €



NEXIO

EMPOTRAR FIJO

Nexio R es un potente downlight, con un exclusivo diseño para disipar el calor.

Destaca su altísima eficacia Lumen / Vatio para sus reducidas dimensiones. Luminaria idónea para la sustitución de lámparas de descarga.

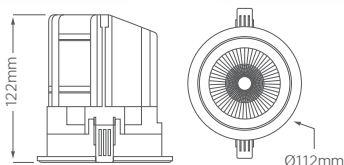

MOLDURA:	Aluminio fundido a presión y pintado a pistola	
COLOR:	Blanco / Titán	
DISIPADOR DE CALOR:	Aluminio extrusionado y anodizado negro	
REGULABLE:	Opcional Regulable o Sistema DALI	
LED:	Sharp	
VOLTAJE:	220-240 V, 50-60Hz	
POTENCIA:	19W - 26W	
FLUJO LUMINOSO (Lm):	2095 lm (700mA 26W 3000K)	NEX100RRS30-26-50
	2278 lm (700mA 26W 4000K)	NEX100RRS40-26-50
LA EFICIENCIA DEL SISTEMA (Lm / W):	84,52 lm/W (26W 3000K)	
	90,29 lm/W (26W 4000K)	
CRI	CRI > 80	
RANGO DE TEMPERATURA:	-20 °C a 36 °C	
HORAS DE VIDA:	40.000 horas a 25 °C	
TEMPERATURA DE COLOR:	● 3000K ○ 4000K	
DRIVER:	MEAN WELL	

COD	DRIVER	W	V	TC	LM	COLOR	▲	🕒	PVR
36283	MEAN WELL	26W	230V	3000K	2095	○	50°	40000h	108,33 €
36306	MEAN WELL	26W	230V	3000K	2095	●	50°	40000h	108,33 €
36290	MEAN WELL	26W	230V	4000K	2278	○	50°	40000h	108,33 €
36313	MEAN WELL	26W	230V	4000K	2278	●	50°	40000h	108,33 €



HYLUX EMPOTRAR FIJO

Hylux 220 R es un downlight de 220 mm ideal para la sustitución, sin obra, del clásico 2x26W o 2x32W de fluorescencia.



MOLDURA:	Aluminio y pintado a pistola	
COLOR:	Blanco / Titán	
DISIPADOR DE CALOR:	Aluminio extrusionado y anodizado negro	
REGULABLE:	Opcional Regulable o Sistema DALI	
LED:	Sharp	
VOLTAJE:	220-240 V, 50-60Hz	
POTENCIA:	26W - 35W - 41W	
FLUJO LUMINOSO (Lm):	1959 lm (700mA 26W 3000K)	HYX220RRS30-26-60
LA EFICIENCIA DEL SISTEMA (Lm / W):	80.77 lm/W (26W 3000K)	81.72 lm/W (26W 4000K)
CRI	CRI > 80	
RANGO DE TEMPERATURA:	-20 °C a 36 °C	
HORAS DE VIDA:	40.000 horas	
TEMPERATURA DE COLOR:	● 3000K ○ 4000K	
DRIVER:	MEAN WELL	

COD	DRIVER	W	V	TC	LM	COLOR	▲	🕒	PVR
36320	MEAN WELL	26W	230V	3000K	1959	○	60°	40000h	108,33 €
38096	MEAN WELL	26W	230V	3000K	1959	●	60°	40000h	108,33 €
36337	MEAN WELL	26W	230V	4000K	2335	○	60°	40000h	108,33 €
38102	MEAN WELL	26W	230V	4000K	2335	●	60°	40000h	108,33 €
36344	MEAN WELL	35W	230V	3000K	2515	○	60°	40000h	158,33 €

AXTOS R

LUMINARIAS | EMPOTRAR ORIENTABLE



AXTOS R

EMPOTRAR ORIENTABLE

Axtos R' es un Downlight LED orientable con un diseño elegante. Es un LED de alto rendimiento con un consumo de electricidad muy bajo, no más de 10W. En definitiva, es un reemplazo completo de lámparas halógenas dicroicas de 50W.

BLANCO TITÁN



MOLDURA:	Aleación de zinc de fundición a presión. Spray de pintura	
COLOR:	Blanco / Titán / Cromo	
DISIPADOR DE CALOR:	Aluminio extrusionado y anodizado negro	
REGULABLE:	Opcional Regulable o Sistema DALI	
LED:	Sharp	
VOLTAJE:	220-240 V, 50-60Hz	
POTENCIA:	10W	
FLUJO LUMINOSO (Lm):	769 lm (500mA 10W 3000K) 833 lm (500mA 10W 4000K)	ATX068RRS30-10 ATX068RRS40-10
LA EFICIENCIA DEL SISTEMA (Lm / W):	87.36 lm/W (10W 3000K) 95.75 lm/W (10W 4000K)	
CRI	3000K = CRI 82.80 4000K = CRI 84.50	
RANGO DE TEMPERATURA:	-20 °C a 36 °C	
HORAS DE VIDA:	40.000 horas a 25 °C	
TEMPERATURA DE COLOR:	● 3000K ○ 4000K	
DRIVER:	HEP	

COD	DRIVER	W	V	TC	LM	COLOR	▲	🕒	PVR
36245	HEP	10W	230V	3000K	769	●	36°	40000h	61,67 €
36238	HEP	10W	230V	4000K	833	○	36°	40000h	61,67 €
36252	HEP	10W	230V	4000K	833	●	36°	40000h	61,67 €



GARLUX SR EMPOTRAR ORIENTABLE

Garlux SR es un luminaria orientable pensada para comercios y restaurantes, gracias a su iluminación homogénea y un eficaz flujo luminoso.

UGR ≤19	BLANCO	TITAN	IP20	40,000
------------	--------	-------	------	--------

95x95	40°	30°
-------	-----	-----

GARLUX 1



MOLDURA:	Estampación de acero y pintado a pistola	
CAJA:	Estampación de acero y anodizado negro	
COLOR:	Blanco / Titán	
DISIPADOR DE CALOR:	Aluminio extrusionado y anodizado negro	
REGULABLE:	Opcional Regulable o Sistema DALI	
LED:	Bridgelux	
VOLTAJE:	220-240 V, 50-60Hz	
POTENCIA:	10W X 1	
FLUJO LUMINOSO (Lm):	707 lm (500mA 10W 3000K)	GAR095SRB30
	750 lm (500mA 10W 4000K)	GAR095SRB40
LA EFICIENCIA DEL SISTEMA (Lm / W):	78.90 lm/W (10W 3000K)	
	87.27 lm/W (10W 4000K)	
CRI	3000K = CRI 82.80	
	4000K = CRI 83.80	
RANGO DE TEMPERATURA:	-20 °C a 36 °C	
HORAS DE VIDA:	40.000 horas a 25 °C	
TEMPERATURA DE COLOR:	● 3000K ○ 4000K	
DRIVER:	MEAN WELL	

COD	DRIVER	W	V	TC	LM	COLOR	△	⌚	PVR
37709	MEAN WELL	10W	230V	3000K	707	○	40°	40000h	70 €
36269	MEAN WELL	10W	230V	3000K	707	●	40°	40000h	70 €
36276	MEAN WELL	10W	230V	4000K	750	●	40°	40000h	70 €

GARLUX SR

LUMINARIAS | EMPOTRAR ORIENTABLE

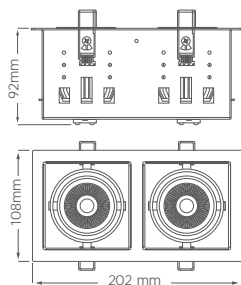

GARLUX 2



MOLDURA:	Estampación de acero y pintado a pistola		
CAJA:	Estampación de acero y anodizado negro		
COLOR:	Blanco / Titán		
DISIPADOR DE CALOR:	Aluminio extrusionado y anodizado negro		
REGULABLE:	Opcional Regulable o Sistema DALI		
LED:	Bridgelux		
VOLTAJE:	220-240 V, 50-60Hz		
POTENCIA:	10W X 2 = 20W		
FLUJO LUMINOSO (Lm):	1408 lm (500mA 20W 3000K)	GAR190SRB30	
	1497 lm (500mA 20W 4000K)	GAR190SRB40	
LA EFICIENCIA DEL SISTEMA (Lm / W):	74.20 lm/W (20W 3000K)		
	86.58 lm/W (20W 4000K)		
CRI	3000K = CRI 83.10		
	4000K = CRI 82.80		
RANGO DE TEMPERATURA:	-20 °C a 36 °C		
HORAS DE VIDA:	40.000 horas a 25 °C		
TEMPERATURA DE COLOR:	● 3000K ○ 4000K		
DRIVER:	MEAN WELL		

COD	DRIVER	W	V	TC	LM	COLOR	△	⌚	PVR
37747	MEAN WELL	20W	230V	3000K	1408	○	40°	40000h	100 €
37754	MEAN WELL	20W	230V	3000K	1408	●	40°	40000h	100 €
37778	MEAN WELL	20W	230V	4000K	1497	●	40°	40000h	100 €

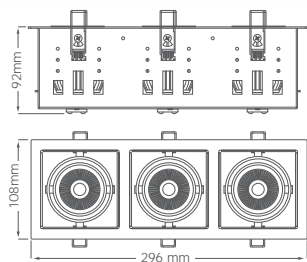

GARLUX 3



MOLDURA:	Estampación de acero y pintado a pistola		
CAJA:	Estampación de acero y anodizado negro		
COLOR:	Blanco / Titán		
DISIPADOR DE CALOR:	Aluminio extrusionado y anodizado negro		
REGULABLE:	Opcional Regulable o Sistema DALI		
LED:	Bridgelux		
VOLTAJE:	220-240 V, 50-60Hz		
POTENCIA:	10W X 3 = 30W		
FLUJO LUMINOSO (Lm):	2116 lm (500mA 30W 3000K)	GAR285SRB30	
LA EFICIENCIA DEL SISTEMA (Lm / W):	68.69 lm/W (30W 3000K)		
CRI	3000K = CRI 83.20		
RANGO DE TEMPERATURA:	-20 °C a 36 °C		
HORAS DE VIDA:	40.000 horas a 25 °C		
TEMPERATURA DE COLOR:	● 3000K		
DRIVER:	MEAN WELL		

COD	DRIVER	W	V	TC	LM	COLOR	△	⌚	PVR
37808	MEAN WELL	30W	230V	3000K	2116	○	40°	40000h	175 €



TITLUX SR

EMPOTRAR ORIENTABLE

Titlux R luminaria de empotrar tipo cardan sencilla o doble con diseño elegante que da un aspecto más sofisticado. Foco de interior orientable 30°. Esta Luminaria es idónea para boutiques, áreas comerciales, etc...

UGR ≤19	BLANCO	TITAN	IP20	40,000
30°	24°	36°	160x160	



MOLDURA:	Acero, Spray de pintura		
COLOR:	Blanco / Titán		
DISIPADOR DE CALOR:	Extrusión de Aluminio, anodizado negro		
ÁNGULO DEL HAZ:	24° - 36°		
REGULABLE:	Opcional Regulable o Sistema DALI		
LED:	Sharp		
VOLTAJE:	100-120 VAC o 220-240 VAC, 50-60Hz		
POTENCIA:	26W		
FLUJO LUMINOSO (LM):	2007 lm (500mA 26W 3000K)	TIT160SR530-26-24	
	2133 lm (500mA 26W 4000K)	TIT160SR540-26-36	
LA EFICIENCIA DEL SISTEMA (LM / W):	77.61 lm/W (26W 3000K 12°)		
	80.18 lm/W (26W 4000K 36°)		
CRI	CRI > 80		
RANGO DE TEMPERATURA:	-20 °C a 36 °C		
HORAS DE VIDA:	40.000 horas a 25 °C		
TEMPERATURA DE COLOR:	● 3000K ○ 4000K		
DIRVER:	MEAN WELL		

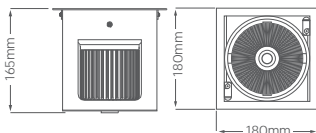

COD	DRIVER	W	V	TC	LM	COLOR	▲	⌚	PVR
39444	MEAN WELL	26W	230V	3000K	2007	●	24°	40000h	116,67 €
39512	MEAN WELL	26W	230V	4000K	2133	○	36°	40000h	116,67 €
39529	MEAN WELL	26W	230V	4000K	2133	●	36°	40000h	116,67 €

LUMINARIAS LED

SUPERFICIE.





CANOLUX

UGR
≤19

IP20

40,000

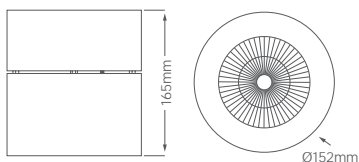

MOLDURA:	Aluminio	
COLOR:	Blanco / Negro	
DISIPADOR DE CALOR:	Aluminio extrusionado y anodizado negro	
REGULABLE:	Opcional Regulable o Sistema DALI	
LED:	Sharp	
VOLTAJE:	220-240 V, 50-60Hz	
POTENCIA:	26W	
FLUJO LUMINOSO (Lm):	1990 lm (500mA 26W 3000K) 2147 lm (500mA 26W 4000K)	CAN150RRS30-26 CAN150RRS40-26
LA EFICIENCIA DEL SISTEMA (Lm / W):	74.52 lm/W (26W 3000K) 80.63 lm/W (26W 4000K)	
CRI	3000K = CRI 83.40 4000K = CRI 85.60	
RANGO DE TEMPERATURA:	-20 °C a 36 °C	
HORAS DE VIDA:	40.000 horas a 25 °C	
TEMPERATURA DE COLOR:	● 3000K ○ 4000K	
DRIVER:	MEAN WELL	

COD	DRIVER	W	V	TC	LM	COLOR	△	⌚	PVR
36368	MEAN WELL	26W	230V	3000K	1990	○	40°	40000h	183,33 €
36382	MEAN WELL	26W	230V	3000K	1990	●	40°	40000h	183,33 €
36399	MEAN WELL	26W	230V	4000K	2147	●	40°	40000h	183,33 €



SORAA®

PASIÓN POR LA PERFECCIÓN

SORAA fue fundada por personas apasionadas; un grupo de expertos en ingeniería y semiconductores, que desafiaron las opiniones generalmente aceptadas para crear diodos electroluminiscentes (LED) GaN on GaN™ con estructuras cristalinas PERFECTAS. Al ser perfecto, el LED que crearon emite una luz de

calidad sin igual, no lograda por ningún otro fabricante: una luz en todo el espectro visible, que revela los colores y los blancos de una manera sin precedentes. Gracias a estos LED excepcionales, SORAA fabrica lámparas que permiten ver colores perfectos, con haz de luz también perfectos.

LUMINARIAS



BARREL
PANEL LED 171



GABLE
PANEL LED 170



ART
CARRIL 172



ARP
SUPERFICIE 174



ARA
AJUSTABLE 176



ARC
DOWNLIGHT 178

LÁMPARAS



PAR16
GU5.3 182



MR16
GU5.3 182



AR111
G53 183



AR111
GU10 183



PAR30S 184



PAR30L 184



PAR38 185

SORAA LOGRA UNA LUZ PERFECTA

Al igual que la luz del sol, la luz de **SORAA** contiene todos los colores del espectro visible, y revela los auténticos y vivos colores de su entorno. Ya no tendrá que conformarse con una luz de calidad "adecuada" o trucos con el espectro luminoso. La luz de **SORAA** es energéticamente eficiente y hará que ahora busque una luz de gran calidad.

SOLUCIONES ESPECIFICAS

- La tecnología de **trifósforo para emisión violeta (VP₃)** logra una luz de espectro completo.
- **VP₃ NATURAL WHITE** garantiza la reproducción fiel y exacta de los blancos.
- **VP₃ VIVID COLOR** para un índice de reproducción cromática (IRC) de 95 y VÍVIDA reproducción de rojos.
- **POINT SOURCE OPTICS** logra un haz de luz uniforme, de alta intensidad, con sombras únicas y bien definidas.
- Funcionamiento sólido y seguro en luminarias cerradas para instalaciones en exteriores e interiores.
- Compatibilidad de atenuación lumínica probada y comprobada.
- **SNAP SYSTEM™**, un sistema galardonado que abre un gran número de posibilidades de diseño.

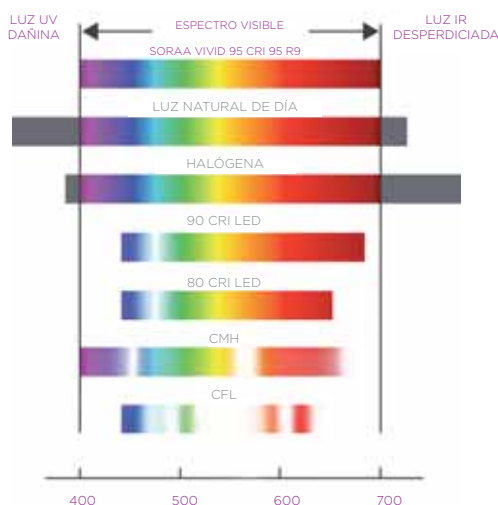

PREMIOS SORAA





SNAP SYSTEM

Remodelar resulta muy fácil con **SNAP**. El galardonado **SNAP SYSTEM™** de **SORAA** es la primera solución de accesorios para lámparas LED, optimizada para funcionar como un sistema integrado. Basada en la tecnología LED de alto brillo y fuente única **GaN on GaN™**, combinada con un innovador conjunto de filtros y lentes magnéticos, ha logrado redefinir por completo la aplicación de accesorios.



A la izquierda: Otros LEDs A la derecha: LED de SORAA



SORAA VIVID
REPRODUCE LOS
COLORES FIELMENTE



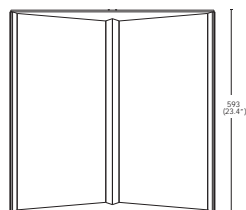
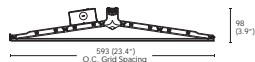

GABLE 600x600

Parecido al modelo BARREL, **Gable** es una panel de led sin marco, dándole una estética vanguardista y creando una luz perfecta y definida. Dispone de dos lentes angulares y uniformes que se enlazan en un elemento central que igualmente brilla con intensidad. Todos los detalles mecánicos se ocultan cuidadosamente en la luminaria. **Gable** está diseñado para techos de escayola y está disponible en las mismas medidas y características técnicas que el modelo Barrel.



REF. INT	W	V	TC	LM	CRI	●	↗	ACABADO	PVR
GB22	25W	120-277V	3000K	2400	90	1-10V	600x600	Aluminio Extrusionado	300 €
GB22	25W	120-277V	3500K	2500	90	1-10V	600x600	Aluminio Extrusionado	300 €
GB22	25W	120-277V	4000K	2600	90	1-10V	600x600	Aluminio Extrusionado	300 €
GB22	35W	120-277V	3000K	3300	90	1-10V	600x600	Aluminio Extrusionado	325 €
GB22	35W	120-277V	3500K	3500	90	1-10V	600x600	Aluminio Extrusionado	325 €
GB22	35W	120-277V	4000K	3600	90	1-10V	600x600	Aluminio Extrusionado	325 €

* Las medidas dadas son en milímetros. Consultar otros modos de regulación - Consultar disponibilidad

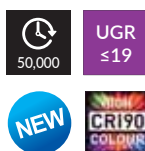
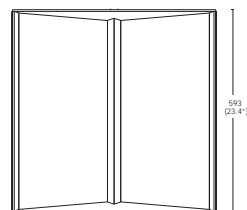
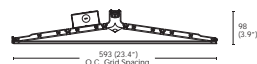

BARREL 600x600

Con tan solo 3" de profundidad, la serie Barrel de Soraa, crea una luz perfecta y definida, tiene forma de arco curvo y está disponible en dimensiones de 2'x 2' y 1'x4'. El marco de aluminio extrusionado de diseño innovador proporciona una perfecta distribución térmica y una separación visual entre el marco y la lente. Además, el detalle del borde del marco en forma cóncava, aumenta la percepción de profundidad del arco de luz. Barrel es un nuevo panel de led diseñado para techos de escayola. Ofrece hasta 3200 lúmenes con CRI90 y las opciones de regulación incluyen 0-10V, Dali, etc....

REF. INT	W	V	TC	LM	CRI	⏻	↕	ACABADO	PVR
BL22	25W	120-277V	3000K	2400	90	1-10V	600x600	Aluminio Extrusionado	300 €
BL22	25W	120-277V	3500K	2500	90	1-10V	600x600	Aluminio Extrusionado	300 €
BL22	25W	120-277V	4000K	2600	90	1-10V	600x600	Aluminio Extrusionado	300 €
BL22	35W	120-277V	3000K	3300	90	1-10V	600x600	Aluminio Extrusionado	325 €
BL22	35W	120-277V	3500K	3500	90	1-10V	600x600	Aluminio Extrusionado	325 €
BL22	35W	120-277V	4000K	3600	90	1-10V	600x600	Aluminio Extrusionado	325 €

* Las medidas dadas son en milímetros. Consultar otros modos de regulación - Consultar disponibilidad



ART

ARC, es la síntesis de la luz perfecta y el diseño. Luminaria de carril de **diseño ultra delgado con disipador de calor optimizado** para una mejor administración térmica del calor.

Incorporando la **tecnología Vivid** con muy alta reproducción de los colores y los blancos,

ART es la solución perfecta para definir a la perfección los haces de luz y el aprovechamiento de luz en el objeto ó espacio deseado. Gracias a su cuidado diseño de vanguardia, **ART** se mimetiza perfectamente en cualquier espacio.

Añádele las lentes para lograr un efecto único ya sea modificando el haz de luz ó la temperatura de color de luz.

Idóneo para museos, galerías, exposiciones, comercios y residencial.



uni**pro**
CARRILES
DISPONIBLES



ART 50 mm

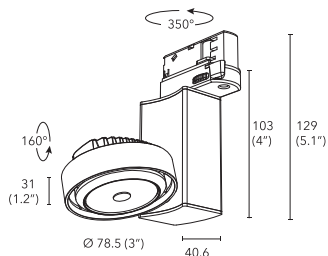

MODELO	V	W	∠	TC	LM	CARRIL	COLOR	SNAP	PVR
ART50	220-240V	11W	10°	2700	535	Trifásico	● ● ●	SI	220 €
				3000					250 €
		18W	15°	2700	930			NO	250 €
				3000					250 €
36°	2700	1000	NO	250 €					
				3000	250 €				

* Las medidas dadas son en milímetros. Consultar otros modos de regulación - Consultar disponibilidad



ART 100 mm

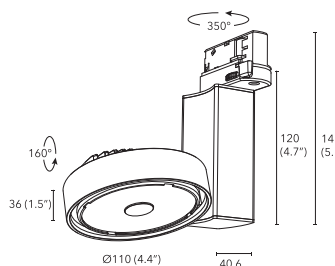

MODELO	V	W	∠	TC	LM	CARRIL	COLOR	SNAP	PVR
ART100	220-240V	20W	9°	2700	1000	Trifásico	● ● ●	NO	275 €
				3000					260 €
				4000					260 €
36°	2700	1050	NO	260 €					
				3000	260 €				

* Las medidas dadas son en milímetros. Consultar otros modos de regulación - Consultar disponibilidad



ARP

ARP, bajo el mismo motor y disipación que el modelo ART.

ARP es una **luminaria en suspensión mediante dos cables de acero protegidos** que a su vez hacen de conducción.

Una luminaria de reducidas dimensiones con mucha potencia y alta reproducción de los colores y los blancos (CRI95). Basculante y ajustable a la posición que se desee para obtener excelentes resultados lumínicos.





ARP 50 mm

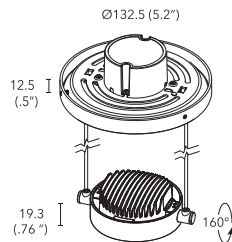

MODELO	V	W	TC	LM	INSTALACIÓN	COLOR	SNAP	PVR
ART50	220-240V	11W	10°	2700	535	● ○ ●	SI	300 €
				3000				325 €
		18W	25°	2700	1000			325 €
				3000				325 €
18W	36°	2700	1000	325 €				
		3000		325 €				

* Las medidas dadas son en milímetros. Consultar otros modos de regulación. El modelo en suspensión incluye un cable eléctrico recubierto de 1981 mm en cada lado, las longitudes pueden ajustarse - Consultar disponibilidad



ARP 100 mm

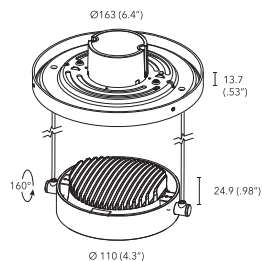

MODELO	V	W	TC	LM	INSTALACIÓN	COLOR	SNAP	PVR	
ART100	220-240V	20W	9°	2700	950	● ○ ●	SI	356 €	
				3000				346 €	
				2700				1050	346 €
				3000					346 €
2700	1050	346 €							
		3000	346 €						

* Las medidas dadas son en milímetros. Consultar otros modos de regulación. El modelo en suspensión incluye un cable eléctrico recubierto de 1981 mm en cada lado, las longitudes pueden ajustarse - Consultar disponibilidad



ARA

ARA, Luminaria de superficie empotrada con accesorio para techo de escayola. **ARA** al igual que los modelos ARC y ARP incorpora la misma tecnología y las mismas posibilidades que ofrece esta familia.

ARA puede generar efectos de luz nunca vistos desde el techo en largas distancias.

ARA Semiempotrada



ARA Empotrada





ARA 50 mm

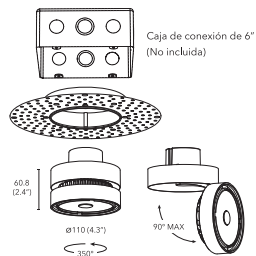

MODELO	V	W	△	TC	LM	INSTALACIÓN	COLOR	SNAP	PVR
ARA50 *	220-240V	11W	10°	2700	535	Semiempotrada superficie	● ○ ●	SI	300 €
				3000					325 €
		18W	25°	2700	1000			3000	325 €
				4000				325 €	
		36°	2700	3000	4000	NO	325 €		

* ARO EMPOTRABLE PARA LA INSTALACIÓN DE ARA - PVR 22€

* Las medidas dadas son en milímetros. Consultar otros modos de regulación - Consultar disponibilidad



ARA 100 mm

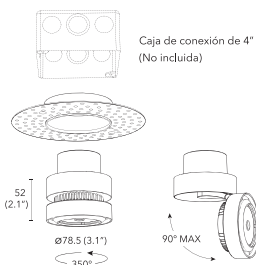

MODELO	V	W	△	TC	LM	INSTALACIÓN	COLOR	SNAP	PVR	
ARA100 *	220-240V	20W	9°	2700	950	Semiempotrada superficie	● ○ ●	SI	356 €	
				3000					346 €	
				25°	2700			1050	3000	346 €
					4000				346 €	
		36°	2700	3000	4000	NO	346 €			
		60°	2700	3000	4000	NO	346 €			

* ARO EMPOTRABLE PARA LA INSTALACIÓN DE ARA - PVR 26€

* Las medidas dadas son en milímetros. Consultar otros modos de regulación - Consultar disponibilidad



ARC DOWNLIGHT

ARC, primer **Downlight basculante** de Soraa con infinitas posibilidades y de reducido tamaño.

Diseño de vanguardia para crear un ambiente de luz homogénea de gran calidad y color.

Luminaria de empotrar redonda ó cuadrada con la posibilidad de intercambiar el aro embellecedor.



Cuadrado con marco



Cuadrado sin marco



Marco cuadrado

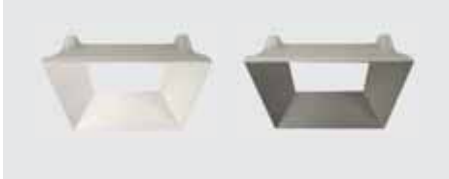

Redondo con marco



Redondo sin marco



Marco redondo





ARC REDONDO

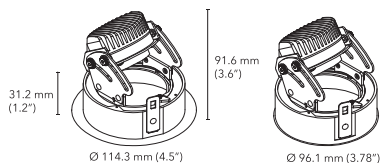

MODELO	V	W	∠	TC	LM	INSTALACIÓN	COLOR	SNAP	PVR
ARC50 REDONDO	220-240V	11W	10°	2700	535	Empotrada	● ○ ●	SI	300 €
				3000					930
		4000	1000	NO	325 €				
		2700			1000			NO	325 €
36°	2700	3000	4000						

* Las medidas dadas son en milímetros. Consultar otros modos de regulación - Consultar disponibilidad y precio



ARC CUADRADO

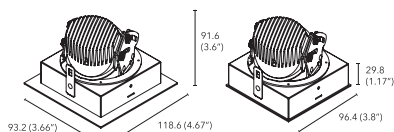

MODELO	W	V	∠	TC	LM	INSTALACIÓN	COLOR	SNAP	PVR
ARC50 CUADRADO	220-240V	11W	10°	2700	535	Empotrada	● ○ ●	SI	Consultar
				3000					930
		4000	1000	NO	Consultar				
		2700			1000			NO	Consultar
36°	2700	3000	4000						

* Las medidas dadas son en milímetros. Consultar otros modos de regulación - Consultar disponibilidad y precio



CLEAR

Crea el ambiente y el efecto cromático preciso que desee en cualquier entorno.

Ø	REF. INT	Transmisión de lúmenes	Grosor
50 mm	AC-CL-0000-00	93%	2 mm
84 mm	AC-E-CL-0000-00	93%	3,1 mm



ENHANCE

Un filtro que realza el color diseñado para modificar el espectro de las luminarias **Soraa VIVID** e **incrementar la intensidad de los colores cálidos** (rojos, naranjas y rosas) **y los verdes**. Utilice Enhance en aquellas aplicaciones donde se busque un color aún más intenso y vibrante.

Ø	REF. INT	Transmisión de lúmenes	Grosor
50 mm	AC-EN-0001-00	75%	2 mm
84 mm	AC-E-EN-0001-00	75%	2 mm



SPREADER

Utilizar para aquellas aplicaciones en las que se necesita **reducir el ángulo de luz**. Disminuye los costes de inventario, reduce la especificación, el diseño y los ciclos de venta. Ofrece la máxima flexibilidad hasta el momento de su instalación.

Ø	REF. INT	Transmisión de lúmenes	Grosor
50 mm	AC-GC-1717-00	17°	2 mm
50 mm	AC-GC-2525-00	25°	2 mm
50 mm	AC-GC-3636-00	36°	2 mm
50 mm	AC-GC-6060-00	60°	2 mm
84 mm	AC-E-GC-1717-00	17°	3,1 mm
84 mm	AC-E-GC-2525-00	25°	3,1 mm
84 mm	AC-E-GC-3636-00	36°	3,1 mm
84 mm	AC-E-GC-6060-00	60°	3,1 mm



LINEAR

Utilizar para **baños de luz sobre pared** y la **iluminación de objetos asimétricos**. Reduce el número necesario de luminarias y la pérdida de luz sobre los objetos iluminados.

Ø	REF. INT	Transmisión de lúmenes	Grosor
50 mm	AC-GE-1025-00	10-25°	2 mm
50 mm	AC-GE-1036-00	10-36°	2 mm
50 mm	AC-GE-1060-00	10-60°	2 mm
84 mm	AC-E-GE-1036-00	10-36°	3,1 mm
84 mm	AC-E-GE-1060-00	10-60°	3,1 mm



FLAT TOP

Ofrece **iluminación uniforme del centro a los bordes**.
Crea un efecto de luz cuadrada.

Ø	REF. INT	△	Transmisión de lúmenes	Grosor
50 mm	AC-FR-2525-00	25x25°	90%	2 mm
50 mm	AC-FR-3636-00	36x36°	90%	2 mm
84 mm	AC-E-FR-3636-00	36x36°	90%	2 mm



AIM

El **Aim Snap** consta de dos lentes y **dobra el haz de 0° a un ángulo de desviación máximo de 20°**, a la vez que mantiene un color y una forma uniforme y constante.

Ø	REF. INT	△	Transmisión de lúmenes	Grosor
50 mm	AC-AM-0020-00	13°	85%	4 mm
84 mm	AC-E-AM-0020-00	13°	85%	6,2 mm



LOUVER

Elimina el deslumbramiento de la luz, haciendo desaparecer los haces de luz en las aplicaciones de downlights. Reduce la intensidad angular a un 0,1 % máximo con un ángulo completo de 40°. Se acopla alrededor de la superficie de la luminaria. Puede utilizarse en combinación con los accesorios de **Soraa ARC**.

Ø	REF. INT	△	Transmisión de lúmenes	Grosor
51,1 mm	AC-LU-4040-00	40°	63%	9 mm
84 mm	AC-E-LU-4040-00	40°	63%	9 mm

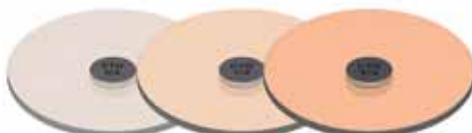

CCT SHIFTER

Utilizar en aplicaciones de hostelería y restaurantes para simular **una iluminación cálida y atenuada**. Crea ambientes personalizados.

Ø	REF. INT	TC	Transmisión de lúmenes	Grosor
50 mm	AC-CC-0001-00	2700K	90%	2 mm
50 mm	AC-CC-0002-00	2400K	75%	2 mm
50 mm	AC-CC-0003-00	2200K	60%	2 mm
84 mm	AC-E-CC-0001-00	2700K	90%	3,1 mm
84 mm	AC-E-CC-0002-00	2400K	75%	3,1 mm
84 mm	AC-E-CC-0002-00	2200K	60%	3,1 mm



PAR16 - MR16

La lámpara que lo cambió todo. Diseñadas para aquellos que exigen la luz de más alta calidad disponible, las lámparas SORAA PAR16 y MR16. El único LED PAR16 y MR16 con tecnologías VP₃ y POINT SOURCE OPTICS.



COD	MODELO	W	V	TC	LM	◀	■	↗	⌚	SNAP	PVR
43434	MR16	7,5W	12V	2700K	390	10°	GU5.3	45,5	50,1	SI	35,83 €
43441	MR16	7,5W	12V	2700K	410	25°	GU5.3	45,5	50,1	NO	31,67 €
43458	MR16	7,5W	12V	2700K	410	36°	GU5.3	45,5	50,1	NO	31,67 €
52009	MR16	7,5W	12V	3000K	410	10°	GU5.3	45,5	50,1	SI	35,83 €
52016	MR16	7,5W	12V	3000K	435	25°	GU5.3	45,5	50,1	NO	31,67 €
52023	MR16	7,5W	12V	3000K	435	36°	GU5.3	45,5	50,1	NO	31,67 €
43465	MR16	7,5W	12V	4000K	430	10°	GU5.3	45,5	50,1	SI	35,83 €
43472	MR16	7,5W	12V	4000K	455	25°	GU5.3	45,5	50,1	NO	31,67 €
43489	MR16	7,5W	12V	4000K	455	36°	GU5.3	45,5	50,1	NO	31,67 €
43625	PAR16	7,5W	230V	2700K	390	10°	GU10	53,5	49,9	SI	39,17 €
43632	PAR16	7,5W	230V	2700K	410	25°	GU10	53,5	49,9	NO	35,83 €
43649	PAR16	7,5W	230V	2700K	410	36°	GU10	53,5	49,9	NO	35,83 €
43656	PAR16	7,5W	230V	2700K	410	60°	GU10	53,5	49,9	NO	35,83 €
52030	PAR16	7,5W	230V	3000K	410	10°	GU10	53,5	49,9	SI	39,17 €
52047	PAR16	7,5W	230V	3000K	435	25°	GU10	53,5	49,9	NO	35,83 €
52054	PAR16	7,5W	230V	3000K	435	36°	GU10	53,5	49,9	NO	35,83 €
52061	PAR16	7,5W	230V	3000K	435	60°	GU10	53,5	49,9	NO	35,83 €
43663	PAR16	7,5W	230V	4000K	430	10°	GU10	53,5	49,9	SI	39,17 €
43670	PAR16	7,5W	230V	4000K	455	25°	GU10	53,5	49,9	NO	35,83 €
43687	PAR16	7,5W	230V	4000K	455	36°	GU10	53,5	49,9	NO	35,83 €
43694	PAR16	7,5W	230V	4000K	455	60°	GU10	53,5	49,9	NO	35,83 €

* Las medidas dadas son en milímetros

SNAP LENTES PAR16 - MR16



COD	MODELO	TC	◀	■	PVR
43519	LENTE VIVID 1/4	2700K	-	GU5.3	12,50 €
43526	LENTE VIVID 1/2	2400K	-	GU5.3	12,50 €
43533	LENTE VIVID 3/4	2200K	-	GU5.3	12,50 €
43540	LENTE VIVID CIRCULAR	-	25°	GU5.3	5,83 €
43557	LENTE VIVID CIRCULAR	-	36°	GU5.3	5,83 €
43564	LENTE VIVID CIRCULAR	-	60°	GU5.3	5,83 €
43571	LENTE VIVID ELIPSE	-	25°	GU5.3	12,50 €
43588	LENTE VIVID ELIPSE	-	36°	GU5.3	12,50 €
43595	LENTE VIVID CUADRADA	-	25°	GU5.3	12,50 €
43601	LENTE VIVID CUADRADA	-	36°	GU5.3	12,50 €
43618	LENTE VIVID CONFORT	-	40°	GU5.3	12,50 €



G53 - 12V

GU10 - 230V



AR111 VIVID

Para aquellos que exigen una iluminación perfecta con el factor de forma **AR111** de bajo perfil, presentamos la unidad **SORAA AR111**. La **AR111** es una importante lámpara para iluminar instalaciones comerciales, que requieren haces de luz puntuales, con bordes muy bien definidos, y que no deslumbren. La **AR111 8°** de **SORAA** con tecnologías **VP3** y **POINT SOURCE OPTICS**, es el único producto LED que coincide con niveles de halógeno.

COD	W	V	TC	LM	△	□	↗	⊙	SNAP	PVR
43816	12,5W	12V	2700K	575	8°	G53	57	111	SI	54,17 €
43823	12,5W	12V	2700K	575	25°	G53	57	111	NO	50 €
43830	12,5W	12V	2700K	575	36°	G53	57	111	NO	50 €
51767	12,5W	12V	3000K	620	8°	G53	57	111	SI	54,17 €
51774	12,5W	12V	3000K	620	25°	G53	57	111	NO	50 €
51781	12,5W	12V	3000K	620	36°	G53	57	111	NO	50 €
51804	12,5W	12V	4000K	645	8°	G53	57	111	SI	54,17 €
51811	12,5W	12V	4000K	645	25°	G53	57	111	NO	50 €
51828	12,5W	12V	4000K	645	36°	G53	57	111	NO	50 €
43854	18,5W	12V	2700K	930	9°	G53	57	111	SI	62,50 €
43861	18,5W	12V	2700K	930	25°	G53	57	111	NO	56,67 €
43878	18,5W	12V	2700K	930	36°	G53	57	111	NO	56,67 €
51842	18,5W	12V	3000K	1000	9°	G53	57	111	SI	62,50 €
51859	18,5W	12V	3000K	1000	25°	G53	57	111	NO	56,67 €
51866	18,5W	12V	3000K	1000	36°	G53	57	111	NO	56,67 €
43892	18,5W	12V	4000K	1040	10°	G53	57	111	SI	62,50 €
43908	18,5W	12V	4000K	1040	25°	G53	57	111	NO	56,67 €
43915	18,5W	12V	4000K	1040	36°	G53	57	111	NO	56,67 €
★ 51897	18,5W	230V	2700K	930	25°	GU10	57	111	NO	65 €

* Las medidas dadas son en milímetros - ★ Últimas unidades



PAR30L Y PAR30S VIVID

La lámpara que lo cambió todo. Diseñadas para aquellos que exigen la luz de más alta calidad disponible, las lámparas SORAA PAR30. El único LED PAR30 con tecnologías VP₃ y POINT SOURCE OPTICS.

PAR30 LARGE

PAR30 SHORT



COD	MODELO	W	V	TC	LM					SNAP	PVR
53037	PAR30S	18,5W	230V	2700K	930	9°	E27	82	96	SI	73,33 €
55000	PAR30S	18,5W	230V	2700K	930	25°	E27	82	96	NO	66,67 €
55017	PAR30S	18,5W	230V	2700K	930	36°	E27	82	96	NO	66,67 €
54256	PAR30S	18,5W	230V	3000K	1000	9°	E27	82	96	SI	73,33 €
55024	PAR30S	18,5W	230V	3000K	1000	25°	E27	82	96	NO	66,67 €
54263	PAR30S	18,5W	230V	3000K	1000	36°	E27	82	96	NO	66,67 €
54232	PAR30L	18,5W	230V	2700K	930	9°	E27	113	96	SI	73,33 €
55031	PAR30L	18,5W	230V	2700K	930	25°	E27	113	96	NO	66,67 €
55048	PAR30L	18,5W	230V	2700K	930	36°	E27	113	96	NO	66,67 €
55055	PAR30L	18,5W	230V	3000K	1000	9°	E27	113	96	SI	73,33 €
55062	PAR30L	18,5W	230V	3000K	1000	25°	E27	113	96	NO	66,67 €
55079	PAR30L	18,5W	230V	3000K	1000	36°	E27	113	96	NO	66,67 €

* Las medidas dadas son en milímetros





PAR38

La lámpara que lo cambió todo. Diseñadas para aquellos que exigen la luz de más alta calidad disponible, las lámparas SORAA PAR38 está disponible en la versión 230V. El único LED PAR38 con tecnologías VP₃ y POINT SOURCE OPTICS.



COD	W	V	TC	LM	△	■	↗	⊙	SNAP	PVR
54249	18,5W	230V	2700K	930	9°	E27	124,6	122,3	SI	75 €
55093	18,5W	230V	2700K	930	25°	E27	124,6	122,3	NO	66,67 €
55109	18,5W	230V	2700K	930	36°	E27	124,6	122,3	NO	66,67 €
54270	18,5W	230V	3000K	1000	9°	E27	124,6	122,3	SI	75 €
55116	18,5W	230V	3000K	1000	25°	E27	124,6	122,3	NO	66,67 €
55123	18,5W	230V	3000K	1000	36°	E27	124,6	122,3	NO	66,67 €
★ 55130	18,5W	230V	4000K	1040	36°	E27	124,6	122,3	NO	66,67 €

* Las medidas dadas son en milímetros - ★ Últimas unidades

SNAP LENTES AR111 - PAR30 - PAR38

COD	MODELO	TC	△	■	PVR
43939	LENTE VIVID 1/4	2700K	-	AR111	18,33 €
43946	LENTE VIVID 1/2	2400K	-	AR111	18,33 €
43953	LENTE VIVID 3/4	2200K	-	AR111	18,33 €
43960	LENTE VIVID CIRCULAR	-	25°	AR111	8,33 €
43977	LENTE VIVID CIRCULAR	-	36°	AR111	8,33 €
43984	LENTE VIVID CIRCULAR	-	60°	AR111	8,33 €
43991	LENTE VIVID ELIPSE	-	36°	AR111	18,33 €
44004	LENTE VIVID CUADRADA	-	36°	AR111	18,33 €
44011	LENTE VIVID CONFORT	-	40°	AR111	18,33 €





PLUMEN

DESIGNER LOW ENERGY LIGHTING

PASIÓN POR EL DISEÑO Y LA ELEGANCIA

Plumen nace de la inspiración y creatividad de jóvenes diseñadores de iluminación en la capital británica. Crear productos de vanguardia eficientes para generar espacios exclusivos donde tecnología y diseño vayan unidos.

El arte de iluminar con gusto requiere de muchos aspectos humanos y técnicos para obtener un acabado exclusivo. Plumen diseña y fabrica lámparas led, luminarias y colgantes para iluminar comercios, restaurantes, hogares, hoteles etc... Galardonada con premios internacionales de diseño y decoración.

LÁMPARAS



001 188



002 189



003 190



WATT NOTT 192



WILBUR 193

LUMINARIAS

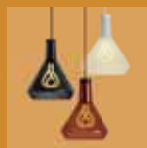

Drop Top 194



Drop Hat 195



Chandelier 196



Drop Pendant 198

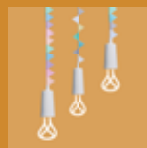

Modern Family 200

001

Plumen 001 fue la primera compacta fluorescente con un verdadero diseño. Ganadora de varios premios como diseño innovador. Una lámpara para verse vista y no estar escondida. 80% de ahorro energético y dura hasta ocho veces más que las lámparas tradicionales. Su temperatura de color 2700K genera un ambiente acogedor y confortable.

Diseñado por HULGER y Samuel Wilkinson.



ACCESORIOS PLUMEN



Colgante Suspensión
Pag - 198



Colgante Sombrero
Pag - 199



Pantalla Suspensión
Pag - 199



Colgante Candelabro
Pag - 196

	W	V	TC	LM	■	CRI	●	↗	⊘	⌚	PVR
LED	10,7W	220-240V	2700K	727	E27	90	SI	-	-	20000h	39 €
CFL	15W	220-240V	2700K	820	E27	80	NO	192x100	91	8000h	34,95 €

* Las medidas dadas son en milímetros



002 NEW

Plumen 002 es la transformación a Led de su antecesor modelo 001. Una lámpara led de diseño exclusivo y diferente. Cuando se combina con un colgante o pantalla ofrece un resultado innovador generando un ambiente cálido y cómodo para los clientes. Regulable con un dimmer a 230V.

Diseñado por HULGER y Bertrand Clerc.



ACCESORIOS PLUMEN



COD	W	V	TC	LM	■	CRI	●	↕	⊘	🕒	PVR
55352	4W	220-240V	2200K	245	E27	80	SI	163x65	65	15000h	44,95 €

* Las medidas dadas son en milímetros



PLUMEN

DESIGNER LOW ENERGY LIGHTING

003

PURA INNOVACIÓN
Y ELEGANCIA



darc awards
/ DECORATIVE

CELEBRATING THE BEST IN LIGHTING DESIGN

003

NEW



Plumen 003 no es solo es una lámpara led bonita de ver, te hace lucir un diseño y una luz nunca vistos antes. Una lámpara Híbrida que combina muchos aspectos funcionales.

Su efecto de luz directa es asombroso y su acento de luz inferior para darle luz al espacio deseado. Luminaria ó lámpara de colgar según por donde , es idónea para iluminar una barra, mesas de comedor, mesillas de noche, comedores de cocina, salones, recepciones de hotel , etc... Premiada con el prestigioso Darc Awards del diseño .

Diseñado por HULGER, Claire Norcross y Marie Laure Giroux.



COD	W	V	TC	LM	■	CRI	●	↗	○	🕒	PVR
55345	6,5W	220-240V	2400K	250	E27	80	SI	135x225	135	15000h	175 €

* Las medidas dadas son en milímetros



LÁMPARA DOBLE FUNCIÓN

Iluminación perfecta y acogedora. Luz ambiental y de acento.

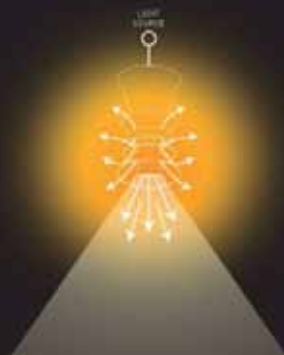

CREA ESPACIOS ÚNICOS CON LAS LÁMPARAS

WATT
NOTT



WATT
WOTT NEW



WILMA



WILLOW



WILBUR

Nuevas y modernas lámparas Vintage de diseño exclusivo.

Desde el lanzamiento de nuestra gama de lámparas vintage **WATTNOTT**, hemos estado explorando la tecnología led con filamentos, buscando nuevas posibilidades y formas para darle un diseño exclusivo tanto si son vistas de forma indirecta como de forma directa generando unos efectos de luz únicos. El vidrio está soplado a mano para darle un toque contemporáneo y diferente entre sí.

Los **modelos Wilma, Willow y Wilbur** ofrecen un color incandescente sin deslumbramiento y generando a su vez un ambiente bien iluminado y confortable a la vista.



COD	MODELO	W	V	TC	LM	■	CRI	●	↗	⊘	⌚	PVR
55383	WILMA	4,3W	220-240V	2100K	300	E27	80	SI	150x175	150	15000h	38,95 €
55376	WILLOW	4,4W	220-240V	2100K	290	E27	80	SI	95x110	95	15000h	27,95 €
55369	WILBUR	4,5W	220-240V	2000K	310	E27	80	SI	60x115	60	15000h	16,95 €

* Las medidas dadas son en milímetros

ACCESORIOS PLUMEN



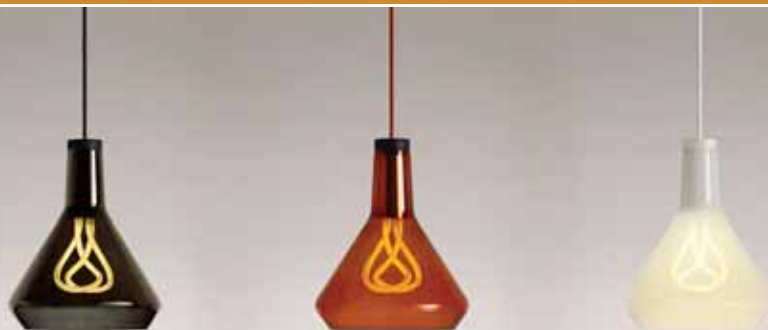

DROP TOP

El **Drop Top** es una pantalla de vidrio tintado soplado que suaviza el brillo de la luz desde cualquier punto de vista, al tiempo que permite ver y disfrutar de la bombilla **Plumen** de cualquier modelo. Las superficies de debajo se iluminan por completo, lo que hace que esta luminaria sea práctica para innumerables aplicaciones.

La pantalla **Drop Top** está diseñada para encajar en nuestro **Drop Pendant Set** y así elegir la combinación que mejor se adapte a sus necesidades.

Diseñado por HULGER

COD	V	COLOR	COLOR COLGANTE	↕	PVR
55444	220-240V	●	●	293x250x2000	135 €
55437	220-240V	○	○	293x250x2000	135 €
55451	220-240V	●	●	293x250x2000	135 €
55468	220-240V	●	○	293x250x2000	135 €

* Las medidas dadas son en milímetros - No incluye lámpara - Incluye Colgante de suspensión (**DROP PENDANT**), cable de suspensión de 2 metros



ACCESORIOS PLUMEN





DROP HAT

El **Drop Hat** es un elegante disco de metal, ideal para quienes desean disfrutar de la belleza de una bombilla desnuda con una pieza de iluminación refinada y elegante.

Perfectamente proporcionado para bombillas Plumen, **Drop Hat** crea impresionantes reflejos y brillos de colores en el ambiente de cualquier espacio.

La pantalla **Drop Hat** está hecha para encajar en nuestro **Drop Pendant Set** y así elegir la combinación que mejor se adapte a sus necesidades.

Diseñado por HULGER

COD	V	COLOR	↗	PVR
55505	220-240V	●	307x15x2000	70 €
55512	220-240V	○	307x15x2000	70 €
55499	220-240V	○	307x15x2000	70 €

* Las medidas dadas son en milímetros - No incluye lámpara - Incluye Colgante de suspensión (**DROP PENDANT**), cable de suspensión de 2 metros



ACCESORIOS PLUMEN





CHANDELIER

Chandelier de **Plumen** es un candelabro en suspensión con 3 ó 4 brazos donde podrás incluir **Drop top**, **Drop Hat** y **Drop pendant** y generar un diseño y ambientes a tu gusto. Podrás combinarlos de la forma que tú quieras.

Incluyendo las lámparas de **Plumen**, el resultado final es espectacular.



COLORES DISPONIBLES

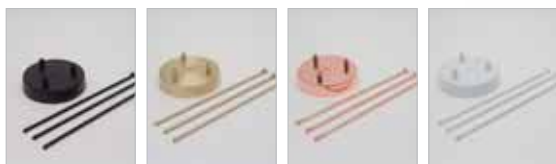



COLGANTE CANDELABRO
BLANCO 3 CABLES
+ 3 ESPACIADORES
+ 3 COLGANTE DE SUSPENSIÓN
(DROP PENDANT)

COD. 55925

144€

3

BLANCO

* Bombillas y pantallas no incluidas



COLGANTE CANDELABRO
NEGRO 3 CABLES
+ 3 ESPACIADORES
+ 3 COLGANTE DE SUSPENSIÓN
(DROP PENDANT)

COD. 55932

144€

3

NEGRO

* Bombillas y pantallas no incluidas



COLGANTE CANDELABRO
DORADO 3 CABLES
+ 3 ESPACIADORES
+ 3 COLGANTE DE SUSPENSIÓN
(DROP PENDANT)

COD. 55949

144€

3

DORADO

* Bombillas y pantallas no incluidas



COLGANTE CANDELABRO
COBRE 3 CABLES
+ 3 ESPACIADORES
+ 3 COLGANTE DE SUSPENSIÓN
(DROP PENDANT)

COD. 55956

144€

3

COBRE

* Bombillas y pantallas no incluidas



COLGANTE CANDELABRO
BLANCO 4 CABLES
+ 4 ESPACIADORES
+ 4 COLGANTE DE SUSPENSIÓN
(DROP PENDANT)

COD. 55963

185€

4

BLANCO

* Bombillas y pantallas no incluidas



COLGANTE CANDELABRO
NEGRO 4 CABLES
+ 4 ESPACIADORES
+ 4 COLGANTE DE SUSPENSIÓN
(DROP PENDANT)

COD. 55970

185€

4

NEGRO

* Bombillas y pantallas no incluidas



COLGANTE CANDELABRO
DORADO 4 CABLES
+ 4 ESPACIADORES
+ 4 COLGANTE DE SUSPENSIÓN
(DROP PENDANT)

COD. 55987

185€

4

DORADO

* Bombillas y pantallas no incluidas



COLGANTE CANDELABRO
COBRE 4 CABLES
+ 4 ESPACIADORES
+ 4 COLGANTE DE SUSPENSIÓN
(DROP PENDANT)

COD. 55994

185€

4

COBRE

* Bombillas y pantallas no incluidas

DROP PENDANT

LUMINARIAS | SUSPENSIÓN

PLUMEN
DESIGNER LOW ENERGY LIGHTING



DROP PENDANT

220 -
240V

NEW

Luminaria con cable de suspensión.

Florón, cable de **2 metros** y portalámparas con embellecedor disponible en 5 colores. Diseñados para alojar lámparas de **Plumen**.

COD	COLOR		PVR
55390	○	55x55x125	34,95 €
55406	●	55x55x125	34,95 €
55413	●	55x55x125	34,95 €
55420	○	55x55x125	34,95 €
55918	●	55x55x125	34,95 €

* Las medidas dadas son en milímetros



ACCESORIOS PLUMEN





ACCESORIOS

PANTALLA DROP TOP



COD	COLOR		ACABADO	PVR
56007	○	240x304	Vidrio soplado	100 €
56014	●	240x304	Vidrio soplado	100 €
56021	●	240x304	Vidrio soplado	100 €

* Las medidas dadas son en milímetros

ACCESORIO DROP HAT



COD	COLOR		ACABADO	PVR
56038	○	Ø307x15	Metal	46 €
56045	●	Ø307x15	Metal	46 €
56052	●	Ø307x15	Metal	46 €

* Las medidas dadas son en milímetros



ACCESORIO CEILING HOOK

Gancho para sujeción de cables en techo

COD	COLOR		MAX. PESO	PVR
55482	○	Ø15x41	2 kg	6,95 €
55475	●	Ø15x41	2 kg	6,95 €

* Las medidas dadas son en milímetros



MODERN FAMILY

Creados por un diseñador, los colgantes Modern Family son únicos en su forma y color. Colgantes de colores vanguardistas y contemporáneos para darle un aire moderno a tu hogar o negocio.



COLGANTE FAMILY HAPPY
+ CABLE PLUMEN de 1,25 m

COD. 55529
89,95€

* Bombillas y pantallas no incluidas



COLGANTE FAMILY SWEET
DREAMS + CABLE PLUMEN de
1,25 m

COD. 56069
89,95€

* Bombillas y pantallas no incluidas



COLGANTE FAMILY RAINBOW
+ CABLE PLUMEN de 1,25 m

COD. 55543
89,95€

* Bombillas y pantallas no incluidas



COLGANTE FAMILY P.A.W
+ CABLE PLUMEN de 1,25 m

COD. 55536
89,95€

* Bombillas y pantallas no incluidas



PLUMEN



unipro®

Lighting track intelligence.



SOLUCIONES AVANZADAS PARA ILUMINACIÓN.

Unipro es una fábrica de origen Finlandés donde producen una amplia gama de carriles trifásicos y accesorios para la industria de la iluminación. Con más de 60 años de experiencia en la fabricación de carriles de aluminio, los productos Unipro se comercializan en más de 50 países y en

estos momentos considerados como uno de los principales fabricantes de carriles a nivel mundial. Los productos Unipro cumplen con las más exigentes certificaciones de calidad en Europa y donde el diseño y la facilidad de instalación les hacen ser una apuesta segura.

CARRILES



Trifásico de Superficie 204



Trifásico de Empotrar 204



Trifásico DALI de Superficie 208



Trifásico DALI de Empotrar 208

CONEXIONES Y ACCESORIOS



Conexiones Trifásico 206



Conexiones Trifásico DALI 210



Tapas 212



Sujeciones - Anclajes 213



Toma de conexión 216



Conexión Luminaria 216



CARRIL TRIFÁSICO

Una amplia gama de carriles trifásicos fabricados en extrusión de aluminio. Los conectores fase y neutro son de cobre rectangular de 2.5 mm². El material de los accesorios es de policarbonato clase V0.

Las alternativas para los carriles de superficie son en color blanco pulverizado (RAL9010), gris (RAL 7040), negro (RAL9005) y color natural anodizado. Todos los demás **colores RAL pintados** y **revestimientos Decoral®** están disponibles bajo pedido expreso.

Medidas del carril:

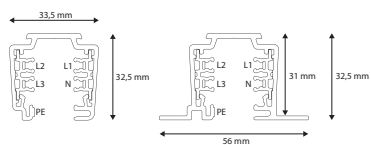

Capacidad de carga:

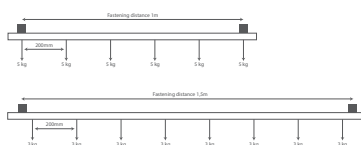

SURPERFICIE TRIFASICO



16A	250/400 VAC	50Hz	Class I	IP20
-----	----------------	------	------------	------

COD	REF. INT.	COLOR	↕	PVR
57943	-	○	1 m	23,50 €
56144	1459103 - T32W	○	2 m	45,00 €
56151	1459104 - T33W	○	3 m	67,50 €
57950	-	●	1 m	23,50 €
57011	1459233 - T32G	●	2 m	45,00 €
57028	1459234 - T33G	●	3 m	67,50 €
57967	-	●	1 m	23,50 €
56168	1459303 - T32B	●	2 m	45,00 €
56175	1459304 - T33B	●	3 m	67,50 €
57974	-	○	1 m	27,00 €
57035	1459203 - T32AD	○	2 m	54,00 €
57042	1459204 - T33AD	○	3 m	81,00 €
57097	1459133 - T32D	Decoral®	2 m	126,50 €
57103	1459134 - T33D	Decoral®	3 m	189,50 €
58025	-	RAL	1 m	40,00 €
57110	1459143 - T32S	RAL	2 m	79,50 €
57127	1459144 - T33S	RAL	3 m	119,00 €

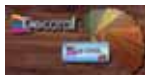

* Las medidas dadas son en metros

EMPOTRADO TRIFASICO



16A	250/400 VAC	50Hz	Class I	IP20
-----	----------------	------	------------	------

COD	REF. INT.	COLOR	↕	PVR
57981	-	○	1 m	25,00 €
56182	1459113 - T32FW	○	2 m	50,00 €
56915	1459114 - T33FW	○	3 m	75,00 €
57998	-	●	1 m	25,00 €
57059	1459183 - T32FG	●	2 m	50,00 €
57066	1459184 - T33FG	●	3 m	75,00 €
58001	-	●	1 m	25,00 €
56199	1459313 - T32FB	●	2 m	50,00 €
56922	1459314 - T33FB	●	3 m	75,00 €
58018	-	○	1 m	32,00 €
57073	1459213 - T32FAD	○	2 m	64,00 €
57080	1459214 - T33FAD	○	3 m	95,00 €
58032	-	RAL	1 m	43,75 €
57134	1459173 - T32FS	RAL	2 m	87,50 €
57141	1459174 - T33FS	RAL	3 m	130,70 €



* Las medidas dadas son en metros

CONECTORES PARA CARRIL TRIFÁSICO

Conectores de corriente de alta calidad para hilos de un máximo de 2,5mm.



CONECTOR CORRIENTE

COD	REF. INT.	COLOR	TIPO	PVR
56205	1459121 - CU3AW	○	A	8,50 €
56212	1459122 - CU3BW	○	B	8,50 €
57158	1459221 - CU3AG	●	A	8,50 €
57165	1459222 - CU3BG	●	B	8,50 €
56229	1459321 - CU3AB	●	A	8,50 €
56236	1459322 - CU3BB	●	B	8,50 €



CONECTOR MEDIO DE UNIÓN

COD	REF. INT.	COLOR	PVR
56243	1459131 - MCU3W	○	21,00 €
57172	1459231 - MCU3G	●	21,00 €
56250	1459331 - MCU3B	●	21,00 €



EMPALME DE UNIÓN

COD	REF. INT.	PVR
56267	1459199 - JU3	5,70 €

CORNER RÍGIDO EN L

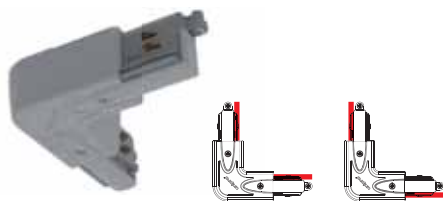

COD	REF. INT.	COLOR	PVR
56274	1459141 - LC3W	○	23,00 €
57189	1459241 - LC3G	●	23,00 €
56281	1459341 - LC3B	●	23,00 €

La posición de la línea de tierra se puede cambiar de posición, atornillando la tapa, girando el marco 180° y volviendo atornillar la tapa.

CORNER AJUSTABLE



COD	REF. INT.	COLOR	PVR
57196	1459151 - ALC3W	○	32,00 €
57202	1459251 - ALC3G	●	32,00 €
57219	1459351 - ALC3B	●	32,00 €

Rango de ajuste horizontal 0 ± 120°.

UNIÓN EN FORMA DE T

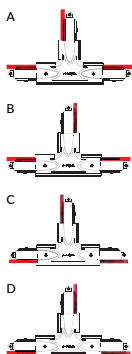

COD	REF. INT.	COLOR	TIPO	PVR
56298	1459161 - TA3AW	○	A	37,50 €
56304	1459162 - TA3BW	○	B	37,50 €
56311	1459163 - TA3CW	○	C	37,50 €
56328	1459164 - TA3DW	○	D	37,50 €
57226	1459261 - TA3AG	●	A	37,50 €
57233	1459262 - TA3BG	●	B	37,50 €
57240	1459263 - TA3CG	●	C	37,50 €
57257	1459264 - TA3DG	●	D	37,50 €
56335	1459361 - TA3AB	●	A	37,50 €
56342	1459362 - TA3BB	●	B	37,50 €
56359	1459363 - TA3CB	●	C	37,50 €
56366	1459364 - TA3DB	●	D	37,50 €

UNIÓN EN FORMA DE X

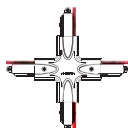

COD	REF. INT.	COLOR	PVR
56373	1459171 - XA3W	○	50,00 €
57264	1459271 - XA3G	●	50,00 €
56380	1459371 - XA3B	●	50,00 €



CARRIL TRIFÁSICO DALI

UNIPRO carriles dimables DALI los conductores de corriente de cobre son redondos de 4mm². El material de los accesorios es de policarbonato clase VO.

Las alternativas para los carriles de superficie son en color blanco pulverizado (RAL9010), gris (RAL 7040), negro (RAL9005) y color natural anodizado. Todos los demás **colores RAL pintados** y **revestimientos Decoral®** están disponibles bajo pedido expreso.

Medidas del carril:

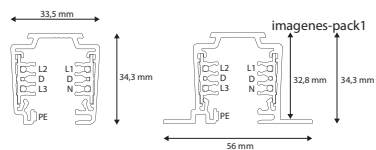

Capacidad de carga:

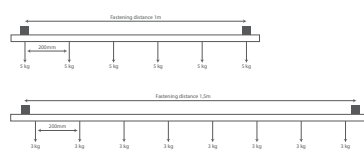

ALICATES DE CORTE PARA CARRIL DALI

COD	REF. INT.	PVR
57929	1459190 - TCCP	Consultar

Alicates de corte de cobre para conductores de fase Control-DALI (L1, L2, L3, N).

SUPERFICIE TRIFÁSICO - Regulación-DALI

16A	250/400 VAC	50Hz	FELV ≤50VAC ≤1A	Class I	IP20
-----	----------------	------	-----------------------	------------	------

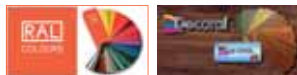

COD	REF. INT.	COLOR	↗	PVR
58049	-	○	1 m	35,00 €
56397	1459108 - TC32W	○	2 m	70,00 €
56939	1459109 - TC33W	○	3 m	105,00 €
58056	-	●	1 m	35,00 €
57271	1459238 - TC32G	●	2 m	70,00 €
57288	1459239 - TC33G	●	3 m	105,00 €
58063	-	●	1 m	35,00 €
56403	1459308 - TC32B	●	2 m	70,00 €
56946	1459309 - TC33B	●	3 m	105,00 €
58070	-	○	1 m	42,00 €
57295	1459208 - TC32AD	○	2 m	80,85 €
57301	1459209 - TC33AD	○	3 m	119,33 €
57356	1459138 - TC32D	Decoral®	2 m	123,00 €
57363	1459139 - TC33D	Decoral®	3 m	182,00 €
58124	-	RAL	1 m	50,00 €
57370	1459148 - TC32S	RAL	2 m	95,00 €
57387	1459149 - TC33S	RAL	3 m	140,00 €

* Las medidas dadas son en metros

EMPOTRADO TRIFÁSICO - Regulación-DALI

16A	250/400 VAC	50Hz	FELV ≤50VAC ≤1A	Class I	IP20
-----	----------------	------	-----------------------	------------	------



COD	REF. INT.	COLOR	↗	PVR
58087	-	○	1 m	49,00 €
56953	1459118 - TC332FW	○	2 m	97,00 €
56960	1459119 - TC33FW	○	3 m	133,50 €
58094	-	●	1 m	49,00 €
57318	1459188 - TC32FG	●	2 m	97,00 €
57325	1459189 - TC33FG	●	3 m	133,50 €
58100	-	●	1 m	49,00 €
56977	1459318 - TC32FB	●	2 m	97,00 €
56984	1459319 - TC33FB	●	3 m	133,50 €
58117	-	○	1 m	58,00 €
57332	1459218 - TC32FAD	○	2 m	110,50 €
57349	1459219 - TC33FAD	○	3 m	150,00 €
58131	-	RAL	1 m	60,00 €
57394	1459178 - TC32FS	RAL	2 m	115,00 €
57400	1459179 - TC33FS	RAL	3 m	155,00 €

* Las medidas dadas son en metros

CONECTORES PARA CARRIL TRIFÁSICO DALI

Conectores de corriente de alta calidad para hilos de un máximo de 2,5 mm.



CONECTOR CORRIENTE - Regulación-DALI

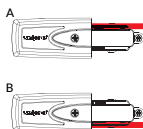

COD	REF. INT.	COLOR	TIPO	PVR
56410	1459125 - CCU3AW	○	A	17,50 €
56427	1459126 - CCU3BW	○	B	17,50 €
57417	1459225 - CCU3AG	●	A	17,50 €
57424	1459226 - CCU3BG	●	B	17,50 €
56434	1459325 - CCU3AB	●	A	17,50 €
56441	1459326 - CCU3BB	●	B	17,50 €

CONECTOR MEDIO DE UNIÓN - Regulación-DALI



COD	REF. INT.	COLOR	PVR
56458	1459129 - CMCU3W	○	35,00 €
57431	1459228 - CMCU3G	●	35,00 €
56465	1459335 - CMCU3B	●	35,00 €

EMPALME DE UNIÓN - Regulación-DALI



COD	REF. INT.	PVR
56472	1459198 - CJU3	13,25 €

CONER RIGIDO EN L - Regulación-DALI

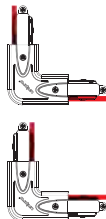

COD	REF. INT.	COLOR	PVR
56489	1459153 - CLC3W	○	35,00 €
57448	1459245 - CLC3G	●	35,00 €
56496	1459345 - CLC3B	●	35,00 €

La posición de la línea de tierra se puede cambiar de posición, atornillando la tapa, girando el marco 180° y volviendo atornillar la tapa.

UNIÓN EN FORMA T - Regulación-DALI

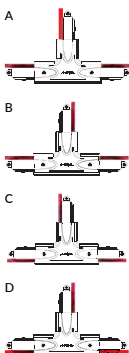

COD	REF. INT.	COLOR	TIPO	PVR
57455	1459155 - CTA3AW	○	A	53,50 €
57462	1459156 - CTA3BW	○	B	53,50 €
57479	1459157 - CTA3CW	○	C	53,50 €
57486	1459158 - CTA3DW	○	D	53,50 €
57493	1459255 - CTA3AG	●	A	53,50 €
57509	1459256 - CTA3BG	●	B	53,50 €
57516	1459257 - CTA3CG	●	C	53,50 €
57523	1459258 - CTA3DG	●	D	53,50 €
57530	1459355 - CTA3AB	●	A	53,50 €
57547	1459356 - CTA3BB	●	B	53,50 €
57554	1459357 - CTA3CB	●	C	53,50 €
57561	1459358 - CTA3DB	●	D	53,50 €

UNIÓN EN FORMA DE X - Regulación-DALI

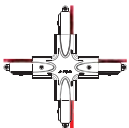

COD	REF. INT.	COLOR	PVR
57578	1459167 - CXA3W	○	76,50 €
57585	1459275 - CXA3G	●	76,50 €
57592	1459375 - CXA3B	●	76,50 €

ACCESORIOS PARA CARRIL

Los carriles **UNIPRO** tiene todo tipo de accesorios para su instalación y funcionamiento. Puedes encontrar tapas, accesorios de sujeción, de conexión para luminarias, etc.



TAPA FINAL

COD	REF. INT.	CONTROL DALI	COLOR	PVR
56502	1459181 - EC3W	NO	○	1,50 €
57608	1459281 - EC3G	NO	●	1,50 €
56519	1459381 - EC3B	NO	●	1,50 €
56526	1459196 - CEC3W	SI	○	1,70 €
57615	1459285 - CEC3G	SI	●	1,70 €
56533	1459385 - CEC3B	SI	●	1,70 €



TAPA BAJO CONEXIONES

COD	REF. INT.	COLOR	PVR
56540	1459191 - CP3W	○	2,90 €
57622	1459291 - CP3G	●	2,90 €
56557	1459391 - PC3B	●	2,90 €

* Pedido mínimo 10 unidades



TAPA BAJO CARRIL

Longitud 2m.

COD	REF. INT.	COLOR	PVR
56564	1459444 - CS3W	○	14,25 €
56571	1459445 - CS3B	●	14,25 €



GRAPA DE SUJECIÓN 15KG

COD	REF. INT.	COLOR	PVR
56588	1459421 - QCB W	○	1,21 €
57639	1459422 - QCB G	●	1,21 €
56595	1459423 - QCB B	●	1,21 €



GRAPA CONEXIÓN RÁPIDA 8KG

COD	REF. INT.	COLOR	PVR
56601	1459100 - QC3G	●	1,10 €



GRAPA DE SUJECIÓN 20KG PARA CABLE DE SUSPENSIÓN

COD	REF. INT.	COLOR	PVR
56618	1459401 - CB3W	○	1,15 €
57653	1459402 - CB3G	●	1,15 €
56625	1459403 - CB3B	●	1,15 €



GRAPA DE SUJECIÓN 5KG PARA CABLE DE SUSPENSIÓN

COD	REF. INT.	COLOR	PVR
56632	1459451 - CB3W T-BAR	○	4,96 €
57660	1459452 - CB3G T-BAR	●	4,96 €
56649	1459453 - CB3B T-BAR	●	4,96 €



GRAPA DE SUJECIÓN GANCHO 20KG PARA CABLE DE SUSPENSIÓN

COD	REF. INT.	COLOR	PVR
56656	1459407 - PB W	○	2,55 €
57677	1459408 - PB G	●	2,55 €
56663	1459409 - PB B	●	2,55 €



GRAPA SUJECIÓN LINEAL 20KG PARA CABLE DE SUSPENSIÓN

COD	REF. INT.	COLOR	PVR
57684	1459431 - PC W	○	7,50 €
57691	1459432 - PC G	●	7,50 €
57707	1459433 - PC B	●	7,50 €



GRAPA AJUSTABLE 20KG PARA CABLE DE SUSPENSIÓN

COD	REF. INT.	COLOR	PVR
56670	1459404 - PBA W	○	10,83 €
57714	1459405 - PBA G	●	10,83 €
56687	1459406 - PBA B	●	10,83 €



GRAPA CON FLORON 10KG PARA CABLE DE SUSPENSIÓN

COD	REF. INT.	COLOR	PVR
56694	1459434 - CBC W	○	3,00 €
56700	1459435 - CBC B	●	3,00 €



GRAPA MURO / TECHO 3KG

COD	REF. INT.	COLOR	PVR
57721	1459436 - WB W	○	1,90 €
57738	1459437 - WB B	●	1,90 €



ABRAZADERA PARA CABLE DE SUSPENSIÓN

COD	REF. INT.	COLOR	PVR
57745	1459440 - SC3W	○	1,25 €
57752	1459441 - SC3G	●	1,25 €
57769	1459442 - SC3B	●	1,25 €



ABRAZADERA GANCHO 1KG PARA CABLE DE SUSPENSIÓN

COD	REF. INT.	COLOR	PVR
57776	1459443 - SH	●	0,70 €



CABLE DE SUSPENSIÓN

COD	REF. INT.	↕	COLOR	PVR
56717	1459410 - WS15	1,5 m	●	7,50 €
57783	1459411 - WS40	4 m	●	11,96 €
57790	1459412 - WS60	6 m	●	21,22 €
56724	1459415 - WS15 B	1,5 m	●	10,25 €
57806	1459416 - WS40 B	4 m	●	14,81 €
57813	1459414 - WS60 B	6 m	●	13,52 €

Medidas dadas en metros.



ACCESORIOS DE MONTAJE

COD	REF. INT.	PRODUCTO	COLOR	PVR
56731	1459420 - GT-6 L=1000 EG	Tija de suspensión M6 de 1m	-	6,00 €
56748	1459425 - JM M6 EG	Tuerca de extensión para tija M6	-	0,38 €
56755	1459427 - MU M6 EG	Tuerca M6	-	0,15 €

Nipple ALN

NM10

HERRAMIENTAS Y EQUIPO



CC70

T1L



COD	REF. INT.	PRODUCTO	↕	PVR
56823	1459091 - ALN10R8	Rosca rotatoria *	8 mm	1,50 €
56830	1459092 - ALN10R12	Rosca rotatoria *	12 mm	1,50 €
56847	1459428 - NM10	Tuerca para rosca rotatoria *	-	0,22 €
56854	1459010 - CC70	Prisionero para cable *	-	0,47 €
56861	1459099 - T1L	LLlave adaptador	-	31,00 €

Medidas dadas en milímetros. * pedido mínimo 100 unidades

CONEXIONES PARA CARRIL

Conexiones para carril Europeo universal **UNIPRO**.



ADAPTADOR UNIVERSAL 5KG

COD	REF. INT.	CONTROL DALI	COLOR	PVR
56762	1459014 - A75W	NO	○	7,50 €
56779	1459016 - A75G	NO	●	7,50 €
57837	1459015 - A75B	NO	●	7,50 €

LLAVE ADAPTADOR UNIVERSAL 5KG *

COD	REF. INT.	CONTROL DALI	COLOR	PVR
57844	1459004 - L70W	NO	○	0,31 €
57851	1459006 - L70G	NO	●	0,31 €
57868	1459005 - L70B	NO	●	0,31 €

* pedido mínimo 100 unidades



ADAPTADOR UNIVERSAL 10KG

COD	REF. INT.	CONTROL DALI	COLOR	PVR
56806	1459029 - A90W	NO	○	10,00 €
56793	1459031 - A90G	NO	●	10,00 €
57875	1459030 - A90B	NO	●	10,00 €



ADAPTADOR UNIVERSAL 10KG - Regulación-DALI

COD	REF. INT.	CONTROL DALI	COLOR	PVR
56809	1459026 - A90CW	SI	○	19,00 €
56816	1459028 - A90CG	SI	●	19,00 €
57882	1459027 - A90CB	SI	●	19,00 €



ADAPTADOR UNIVERSAL BLUETOOTH 5KG *

COD	REF. INT.	COLOR	PVR
57899	1459017 - AB80BT W	○	168,00 €
57905	1459019 - AB80BT G	●	168,00 €
57912	1459418 - AB80BT B	●	168,00 €

* Pedido mínimo 5 unidades



TOMA DE CORRIENTE

COD	REF. INT.	COLOR	PVR
56991	1459011 - A100W	○	15,00 €
57820	1459013 - A100G	●	15,00 €
57004	1459012 - A100B	●	15,00 €



BASE SUPERFICIE 5KG

COD	REF. INT.	COLOR	PVR
56878	1459040 - MP W	○	18,00 €
57936	1459042 - MP G	●	18,00 €
56885	1459041 - MP B	●	18,00 €



MM Electric

MM electric marca de vanguardia para soluciones de iluminacion led. Amplia gama de luminarias y lámparas de diferentes tipologías para un cliente que busca un resultado con garantías.

CHIP

The logo for Bridgelux, featuring the word "bridgelux" in a lowercase, sans-serif font with a red arc above the "i" and "l".The logo for Citizen, with the word "CITIZEN" in a bold, uppercase, sans-serif font and "Micro-lluminattech" in a smaller font below it.The logo for Cree, with the word "CREE" in a bold, uppercase, sans-serif font and a stylized diamond shape to the right.The logo for Samsung, with the word "SAMSUNG" in a bold, uppercase, sans-serif font inside a blue oval.The logo for Epistar, with the word "EPISTAR" in a bold, uppercase, sans-serif font.The logo for Edison, with a stylized "E" containing a lightbulb icon and the word "EDISON" in a bold, uppercase, sans-serif font.The logo for Nichia, with a stylized "N" and the word "NICHIA" in a bold, uppercase, sans-serif font.

DRIVER

The logo for Mean Well, with the letters "MW" in a bold, white, sans-serif font inside a red square, and the words "MEAN WELL" in a smaller, white, sans-serif font below it.



LUMINARIAS



Downlight Redondo 223



Downlight Cuadrado 224



Tile 225



Shoplighter 226



Downlight Superficie 227



Tiras Led 228



Ricco 229



Decco 230



Campana Fresh 232



Campana Pink 233



Campana Bay 236



Campana Storm 234



Delta Slim 237

DOWNLIGHT

LUMINARIAS | EMPOTRAR FIJO

MM *Electric*



DOWNLIGHT

EMPOTRAR FIJO





DOWNLIGHT REDONDOS



	COD	W	V	TC	LM	CRI	COLOR	●	↗	↻	🕒	PVR
NEW	45926	6W	230V	3000K	510	80	○	NO	120	105	25000h	11,67 €
NEW	51002	6W	230V	3000K	510	80	●	NO	120	105	25000h	11,67 €
NEW	44936	6W	230V	4000K	510	80	○	NO	120	105	25000h	11,67 €
NEW	51019	6W	230V	4000K	510	80	●	NO	120	105	25000h	11,67 €
NEW	45933	12W	230V	3000K	1020	80	○	NO	170	155	25000h	16,67 €
NEW	51026	12W	230V	3000K	1020	80	●	NO	170	155	25000h	16,67 €
NEW	44943	12W	230V	4000K	1020	80	○	NO	170	155	25000h	16,67 €
NEW	51033	12W	230V	4000K	1020	80	●	NO	170	155	25000h	16,67 €
	42079	18W	230V	3000K	1450	80	○	NO	225	200	25000h	21,67 €
	43274	18W	230V	3000K	1450	80	●	NO	225	200	25000h	21,67 €
	42086	18W	230V	4000K	1450	80	○	NO	225	200	25000h	21,67 €
	43281	18W	230V	4000K	1450	80	●	NO	225	200	25000h	21,67 €
	42277	18W	230V	6000K	1450	80	○	NO	225	200	25000h	21,67 €
	44844	18W	230V	6000K	1450	80	●	NO	225	200	25000h	21,67 €
	41218	20W	230V	3000K	1620	80	○	NO	240	225	25000h	25 €
	43298	20W	230V	3000K	1620	80	●	NO	240	225	25000h	25 €
	41201	20W	230V	4000K	1620	80	○	NO	240	225	25000h	25 €
	42871	20W	230V	4000K	1620	80	●	NO	240	225	25000h	25 €
	42307	20W	230V	6000K	1620	80	○	NO	240	225	25000h	25 €
	44851	20W	230V	6000K	1620	80	●	NO	240	225	25000h	25 €

* Consultar otras temperaturas de color - Las medidas dadas son en milímetros



DOWNLIGHT CUADRADOS



COD	W	V	TC	LM	CRI	COLOR	●	↗	↙	🕒	PVR
42888	6W	230V	3000K	510	80	○	NO	120x120	100x100	25000h	11,67 €
42895	6W	230V	4000K	510	80	○	NO	120x120	100x100	25000h	11,67 €
42901	12W	230V	3000K	1020	80	○	NO	170x170	150x150	25000h	16,67 €
42918	12W	230V	4000K	1020	80	○	NO	170x170	150x150	25000h	16,67 €
42093	18W	230V	3000K	1450	80	○	NO	225x225	200x200	25000h	21,67 €
42802	18W	230V	3000K	1450	80	●	NO	225x225	200x200	25000h	21,67 €
42109	18W	230V	4000K	1450	80	○	NO	225x225	200x200	25000h	21,67 €
44837	18W	230V	4000K	1450	80	●	NO	225x225	200x200	25000h	21,67 €

* Consultar otras temperaturas de color - Las medidas dadas son en milímetros





TILE
EMPOTRAR FIJO



	COD	W	V	TC	LM	CRI	COLOR	☐	↗	MT	🕒	PVR
★	42550	36W	230V	4000K	2850	80	○	NO	600x600	595x595	30000h	30 €
★	42567	36W	230V	6000K	2850	80	○	NO	600x600	595x595	30000h	30 €
★	42581	48W	230V	4000K	3800	80	○	NO	600x600	595x595	30000h	40 €
★	42598	48W	230V	6000K	3800	80	○	NO	600x600	595x595	30000h	40 €

* Driver incluido - Consultar otras medidas. - Las medidas dadas son en milímetros. - ★ Últimas unidades

SHOP LIGHTER

LUMINARIAS | EMPOTRAR ORIENTABLE

MM Electric



SHOP LIGHTER

EMPOTRAR ORIENTABLE

Luminaria rectangular basculante idónea para la iluminación de escaparates o bañador de muro para resaltar los productos expuestos.

Novedad versión **PINK** para la iluminación de productos carnicos.

bridgelux®



	COD	W	V	TC	LM	CRI	COLOR	☉	↕	LTZ	USO	🕒	PVR
★	41935	28W	230V	5000K	2399	90	○	SI	240x145	220x135	-	40000h	100 €
★	45902	28W	230V	●	2660	90	○	SI	240x145	220x135	📱 📺 📺	40000h	116,67 €
★	41959	48W	230V	5000K	4041	90	○	SI	240x145	220x135	-	40000h	141,67 €

* Las medidas dadas son en milímetros. - 🇪🇸 Últimas unidades

DOWNLIGHT SUPERFICIE



REDONDOS



	COD	W	V	TC	LM	CRI	COLOR				PVR
NEW	45940	12W	230V	3000K	1000	80	○	NO	170	25000h	20 €
NEW	45957	12W	230V	4000K	1000	80	●	NO	170	25000h	20 €
	42314	20W	230V	3000K	1600	80	○	NO	240	25000h	30 €
	42321	20W	230V	4000K	1600	80	●	NO	240	25000h	30 €
NEW	52498	36W	230V	3000K	2950	80	○	NO	400	25000h	48,33 €
NEW	52504	36W	230V	4000K	2950	80	●	NO	400	25000h	48,33 €
NEW	52511	48W	230V	3000K	3950	80	○	NO	600	25000h	65 €
NEW	52528	48W	230V	4000K	3950	80	●	NO	600	25000h	65 €

* Las medidas dadas son en milímetros



CUADRADOS



	COD	W	V	TC	LM	CRI	COLOR				PVR
NEW	51064	12W	230V	3000K	1000	80	○	NO	170x170	25000h	20 €
NEW	51071	12W	230V	4000K	1000	80	●	NO	170x170	25000h	20 €
	42338	20W	230V	3000K	1600	80	○	NO	240x240	25000h	30 €
	42345	20W	230V	4000K	1600	80	●	NO	240x240	25000h	30 €

* Las medidas dadas son en milímetros



TIRAS LED



5 M



COD	W	V	TC	IP			PVR
38218	24W	12V	4000K	IP67	5 m	25000h	25 €
44110	108W	12V	3000K	IP55	5 m	25000h	100 €
44127	108W	12V	6000K	IP55	5 m	25000h	100 €
25119	72W	12V		-	5 m	25000h	133,33 €
25126	72W	12V		-	5 m	25000h	133,33 €
25133	72W	12V		-	5 m	25000h	133,33 €
-	72W	24V		IP55	5 m	25000h	133,33 €
44035	24W	24V	3000K	IP20	5 m	25000h	26,67 €
44042	24W	24V	6000K	IP20	5 m	25000h	26,67 €
44073	36W	24V	3000K	IP55	5 m	25000h	41,67 €
44080	36W	24V	6000K	IP55	5 m	25000h	41,67 €
44059	48W	24V	3000K	IP20	5 m	25000h	41,67 €
44066	48W	24V	6000K	IP20	5 m	25000h	41,67 €
44097	72W	24V	3000K	IP55	5 m	25000h	58,33 €
44103	72W	24V	6000K	IP55	5 m	25000h	58,33 €

* Las medidas dadas son en metros

VINTAGE GOLDEN

COD	W	V	TC	IP			PVR
51491	48W	24V	2300K	IP20	5 m	25000h	54,17 €
51507	48W	24V	2300K	IP65	5 m	25000h	62,50 €
51514	72W	24V	2300K	IP20	5 m	25000h	66,67 €
51507	72W	24V	2300K	IP65	5 m	25000h	76,67 €
53778	96W	24V	2300K	IP20	5 m	25000h	98 €
53785	96W	24V	2300K	IP65	5 m	25000h	145 €

* Las medidas dadas son en metros

DRIVER



COD	W	V	PVR	COD	W	V	PVR
32995	25W	12V	20 €	33008	100W	12V	40,42 €
44790	25W	24V	20 €	39055	100W	24V	40,42 €
35293	50W	12V	24,58 €	44806	150W	12V	42,50 €
35286	50W	24V	24,58 €	44813	150W	24V	42,50 €

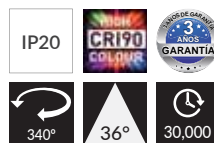

RICCO



	CÓDIGO	W	V	TC	LM	CRI	ACABADO	●	↕	⊙	🕒	PVR
★	44271	30W	230V	3000K	2700	90	●	NO	225	77	30000h	80 €
★	44288	30W	230V	4000K	2700	90	●	NO	225	77	30000h	80 €
★	44318	40W	230V	3000K	3600	90	○	NO	225	77	30000h	80 €
★	44325	40W	230V	4000K	3600	90	○	NO	225	77	30000h	80 €
★	44417	50W	230V	3000K	4000	90	●	NO	225	77	30000h	120 €
★	44400	50W	230V	4000K	4000	90	●	NO	225	77	30000h	120 €
★	44424	50W	230V	4000K	4000	90	●	NO	225	77	30000h	120 €

* Las medidas dadas son en milímetros - 🇪🇸 Últimas unidades





DECCO **NEW**



	CÓDIGO	W	V	TC	LM	CRI	ACABADO	●	↕	⊙	🕒	PVR
★	51149	35W	230V	3000K	3150	90	○	NO	150	106	30000h	80 €
★	51156	35W	230V	3000K	3150	90	●	NO	150	106	30000h	80 €
★	51170	35W	230V	4000K	3150	90	○	NO	150	106	30000h	80 €
★	51187	35W	230V	4000K	3150	90	●	NO	150	106	30000h	80 €

* Las medidas dadas son en milímetros - 🇪🇸 Últimas unidades



MM *Electric*

SUSPENSIÓN CAMPANAS LED

MM ELECTRIC presenta la familia de Campanas Led **FRESH** para comercios, fruterías, panaderías, hostelería, cocinas, supermercados y carnicerías. Tecnología Led CITIZEN / BRIDGELUX con un alto índice CRI90 para respetar los colores y realzar los productos que se quieren iluminar. Tres potencias distintas, cuatro temperaturas de color y cuatro colores a elegir.

Campanas Fresh Led **PINK** ideal para carnicería por su resaltado color de luz en rosa / natural con índice CRI 90.

Potencia, diseño y garantía unido a una familia de campanas led de reducido tamaño con cable de sujeción y de alimentación incluidos.

Las campanas **BAY** se utilizan para un uso industrial en sustitución de iluminación de lámparas de descarga, hasta un 70% de ahorro de energía.

CAMPANA FRESH

LUMINARIAS | SUSPENSIÓN

MM Electric



ESPECIAL ALIMENTACIÓN
CAMPANAS LED

Fresh

CITIZEN
Micro HumanTech



IP40



COD	W	V	TC	LM	CRI	COLOR	☉	☒	🕒	PVR
45520	30W	230V	3000K	1700	90	●	NO	29	30000h	133,33 €
45469	30W	230V	3000K	1700	90	○	NO	29	30000h	133,33 €
43304	30W	230V	3000K	1700	90	●	NO	29	30000h	133,33 €
43311	30W	230V	3000K	1700	90	●	NO	29	30000h	133,33 €
43328	30W	230V	3000K	1700	90	●	NO	29	30000h	133,33 €
45476	40W	230V	3000K	2300	90	○	NO	29	30000h	150 €
43359	40W	230V	3000K	2300	90	●	NO	29	30000h	150 €
43366	40W	230V	3000K	2300	90	●	NO	29	30000h	150 €
43373	40W	230V	3000K	2300	90	●	NO	29	30000h	150 €

* Las medidas dadas son en centímetros - Consultar la versión en 4000K y 5000K - Consultar disponibilidad



ESPECIAL ALIMENTACIÓN
CAMPANAS LED

PINK



bridgelux.

	COD	W	V	TC	LM	CRI	COLOR	☐	⊘	🕒	PVR
NEW	45537	30W	230V	PINK	1700	90	●	NO	29	30000h	150 €
NEW	45513	30W	230V	PINK	1700	90	●	NO	29	30000h	150 €
	43342	30W	230V	PINK	1700	90	●	NO	29	30000h	150 €
	43380	40W	230V	PINK	2300	90	●	NO	29	30000h	166,67 €

* Las medidas dadas son en centímetros - Consultar otros colores ● ● - Consultar disponibilidad

CAMPANA STORM

NEW



STORM es la nueva generación de campanas led fabricadas con un nuevo diseño innovador que mejora la eficiencia energética y lumínica.

- Fabricada con materiales y componentes de primera calidad.
- Hasta 140 lúmenes x watio.
- Sustitución real de campanas de halogenuro metálico de 250W y 400W, ahorrando hasta un 60% de energía.
- Temperatura de color blanco neutro 4.000K.
- Vida útil de 50.000h y garantía de hasta 5 años de funcionamiento *
- 90° de apertura de para focalizar la luz donde realmente se necesita.
- Menor deslumbramiento gracias a su UGR 22.
- Opcional: versión regulable 0-10V y regulable Dali.
- Dimensiones y peso reducidos.
- Se suministra con gancho y cable de 30cm para su fácil conexión.

Mejores soluciones para las Campanas Led STORM



Resistentes al agua **IP65**



AC100-277V 50/60Hz



Fácil instalación



140 Lm/W





COD	W	V	TC	LM	∠	CRI	COLOR	↗	⊘	⌚	PVR
54041	100W	230V	4000K	11000	90°	80	●	191,3	340	50000h	175 €
54058	150W	230V	4000K	21000	90°	80	●	191,3	340	50000h	220 €

Medidas dadas en milímetros - Consultar la versión Dimable 0-10V y Dimable DALI - * Consultar condiciones de garantía - Consultar disponibilidad





ESPECIAL INDUSTRIA CAMPANAS LED

BAY

bridgelux®

MW
MEAN WELL

3 AÑOS
GARANTÍA

IP65

CRI
80

30,000

COD	W	V	TC	LM	△	CRI	☉	☉	🕒	PVR
38836	80W	230V	3000K	6800	45° - 90° - 120°	80	NO	-	30000h	233,33 €
38843	80W	230V	5000K	6800	45° - 90° - 120°	80	NO	-	30000h	233,33 €
38850	100W	230V	3000K	9000	45° - 90° - 120°	80	NO	-	30000h	300 €
38867	100W	230V	5000K	9000	45° - 90° - 120°	80	NO	-	30000h	300 €
38874	120W	230V	3000K	10800	45° - 90° - 120°	80	NO	-	30000h	333,33 €
38881	120W	230V	5000K	10800	45° - 90° - 120°	80	NO	-	30000h	333,33 €
38898	150W	230V	3000K	14000	45° - 90° - 120°	80	NO	-	30000h	383,33 €
38904	150W	230V	5000K	14000	45° - 90° - 120°	80	NO	-	30000h	383,33 €

* Las medidas dadas son en milímetros - Consultar otras potencias - El reflector se suministra aparte - Consultar disponibilidad



REFLECTORES

COD	△	📦
44462	45°	29,17 €
44479	90°	29,17 €
44486	120°	29,17 €



DELTA SLIM PROYECTOR



IP66

CRI
80



COD	W	V	TC	LM	CRI	COLOR	☾	↗	🕒	PVR
45223	24W	230V	3000K	2000	80	○	NO	170x220	50000h	75 €
45230	24W	230V	3000K	2000	80	●	NO	170x220	50000h	75 €
45247	24W	230V	5700K	2200	80	○	NO	170x220	50000h	75 €
45254	24W	230V	5700K	2200	80	●	NO	170x220	50000h	75 €
45261	48W	230V	3000K	4000	80	○	NO	225x290	50000h	150 €
45278	48W	230V	3000K	4000	80	●	NO	225x290	50000h	150 €
45285	48W	230V	5700K	4500	80	○	NO	225x290	50000h	150 €
45292	48W	230V	5700K	4500	80	●	NO	225x290	50000h	150 €
45308	72W	230V	3000K	5700	80	○	NO	250x372	50000h	208,33 €
45315	72W	230V	3000K	5700	80	●	NO	250x372	50000h	208,33 €
45322	72W	230V	5700K	6500	80	○	NO	250x372	50000h	208,33 €
45339	72W	230V	5700K	6500	80	●	NO	250x372	50000h	208,33 €

* Las medidas dadas son en milímetros - Consultar temperatura de color en 4000K - Consultar disponibilidad

BRAZO SUJECCIÓN



COD	COLOR	↗	PVR
45421	○	500	29,17 €
45438	●	500	29,17 €
45445	○	800	58,33 €
45452	●	800	58,33 €

* Las medidas dadas son en milímetros



NINE BY GLASS / ВИНО ПО Б

150ML

RED WINES / ВИНО ПО Б

- BORDEAUX PINOT NOIR 450
- CABERNET SAUVIGNON 450
- MERLOT 450
- PINOT NOIR 450
- SYRAH 450
- ZINFANDEL 450

WHITE WINES / БЕЛЫЕ ВИНО

- CHARDONNAY 450
- SAUVIGNON BLANC 450
- PINOT GRIS 450
- RIESLING 450
- SHARONNEAU 450
- VITIGNA NERO 450

BEER

- PILSENER BEER 450
- LAGER BEER 450
- IPA 450
- STOUT 450
- PORTER 450
- GUINNESS 450



LÁMPARAS



LightBeer 240



LightWatter 242



LightWine 243



Vintage Golden 244



Twitter Golden 247



Ambar Golden 248

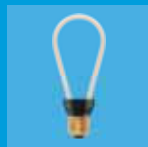

Golden Ring 249



Golden Curve 250



Cable de Colores 249



Titán 252



Street Lamp 254



Reflectoras 255



Par 16 256



MR16 257



Bi-pin G9 258



Tubos 259



Piscina 261



AR70 261

NEW
Light Beer[®]

La Original



Lo último en lámparas vintage, las **LightBeer** son lámpara led con temperatura de color desde 1800K a 4200K y regulables, con forma de botella de cerveza y disponible en cuatro colores.



COD	ACABADO	W	V	TC	LM	■	CRI	●	↗	🕒	PVR
53426 + 53440	●	8W	240V	4200K	160	E27	90	SI	205x56	15000h	34 €
53433 + 53440	●	8W	240V	1800K	160	E27	90	SI	192x57	15000h	34 €
53402 + 53440	Transparente	8W	240V	2200K	360	E27	90	SI	218x57	15000h	34 €
53419 + 53440	●	8W	240V	2800K	250	E27	90	SI	202x56	15000h	34 €

* Las medidas dadas son en milímetros



DISEÑO EXCLUSIVO
E INNOVADOR

Light
Beer®

NEW



LIGHTBEER SIN ETIQUETA



COD	ACABADO	W	V	TC	LM	E27	CRI	☾	↗	🕒	PVR
53426	●	8W	240V	4200K	160	E27	90	SI	205x56	15000h	27 €
53433	●	8W	240V	1800K	160	E27	90	SI	192x57	15000h	27 €
53402	Transparente	8W	240V	2200K	360	E27	90	SI	218x57	15000h	27 €
53419	●	8W	240V	2800K	250	E27	90	SI	202x56	15000h	27 €

* Las medidas dadas son en milímetros

Personaliza tu Lámpara
LightBeer con la imagen
que tu quieras.

Envíanos tu diseño o
nosotros te lo diseñamos.

Light
Beer®

+



Light
Water®



NEW

High
CR190
COLOUR

360°

DIMABLE

Lo último en lámparas vintage, las **Lightwater** son lámparas led con forma de botella de agua con temperatura de color desde 2200K a 2800k y regulables. Disponibles en cinco acabados diferentes. Decora e ilumina tu negocio de una forma elegante y diferente.

**TU
DISEÑO**

Personaliza tu Lámpara *LightWater* con la imagen que tu quieras.

COD	ACABADO	W	V	TC	LM		CRI				PVR
53846	●	8W	240V	2200K	325	E27	90	SI	230x56	15000h	28 €
53822	●	8W	240V	2200K	390	E27	90	SI	230x56	15000h	28 €
53808	●	8W	240V	2200K	320	E27	90	SI	230x56	15000h	28 €
53815	●	8W	240V	2200K	400	E27	90	SI	230x56	15000h	28 €
53839	●	8W	240V	2800K	350	E27	90	SI	230x56	15000h	28 €

* Las medidas dadas son en milímetros





Light Wine®

Lo último en lámparas vintage, las **Lightwine** son lámparas led con forma de botella de vino con temperatura de color desde 1800K a 2800K y regulables. Disponibles en dos acabados diferentes. Decora e ilumina tu negocio de una forma elegante y diferente.



COD	ACABADO	W	V	TC	LM	■	CRI	●	↗	🕒	PVR
55314	●	12W	220-240V	2800K	250	E27	90	SI	330x63	15000h	32 €
55321	●	12W	220-240V	1800K	150	E27	90	SI	330x63	15000h	32 €

* Las medidas dadas son en milímetros

Personaliza tu Lámpara *LightWine* con la imagen que tu quieras.

Envíanos tu diseño o nosotros te lo diseñamos.





NUEVA GAMA VINTAGE GOLDEN LED

2200K Y DIMABLE



Descubre la familia completa de lámparas vintage golden led más famosas del mercado. Lámparas led de estilo vintage con temperatura de color 1800k y 2200k, dimables y alto índice de reproducción cromática.

Nuestra gama de lámparas Vintage Golden están construidas con un filamento led largo para crear un efecto visual como las lámparas de carbono tradicionales y así evitar el deslumbramiento. Crean un efecto único y de estilo verdaderamente Vintage



SERIE EDISON

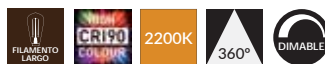

COD	MODELO	W	V	TC	LM	■	CRI	●	↗	○	🕒	PVR
42956	EDISON CLASSIC	6W	230V	2200K	560	E27	90	SI	135	60	15000h	16 €
46084	EDISON BLACK SMOOTH	6W	230V	2200K	300	E27	90	SI	135	60	15000h	17,50 €
46091	MINI EDISON	4W	230V	2200K	350	E14	90	SI	109	45	15000h	12,50 €

* Las medidas dadas son en milímetros

SERIE CLASSIC

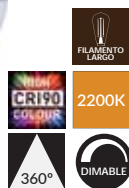

SERIE BULLET

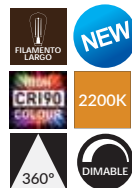

COD	MODELO	W	V	TC	LM	■	CRI	●	↗	○	🕒	PVR
42970	CLASSIC	6W	230V	2200K	560	E27	90	SI	108	60	15000h	14,90 €
46145	CLASSIC MATE	8W	230V	2200K	640	E27	90	SI	108	60	15000h	17 €
46077	CLASSIC CUPULA	6W	230V	2200K	400	E27	90	SI	108	60	15000h	18 €
53013	BULLET	2,7W	230V	2200K	180	E27	90	SI	70	45	15000h	9,50 €

* Las medidas dadas son en milímetros

SERIE GLOBO



COD	MODELO	W	V	TC	LM	■	CRI	●	↗	○	🕒	PVR
42963	GLOBO TRANSPARENTE	8W	230V	2200K	750	E27	90	SI	160	125	15000h	24 €
46121	GLOBO ORO	8W	230V	2200K	450	E27	90	SI	160	125	15000h	29 €
46138	GLOBO PLATA	8W	230V	2200K	450	E27	90	SI	160	125	15000h	29 €
46114	GLOBO COBRE	8W	230V	2200K	450	E27	90	SI	160	125	15000h	29 €
53891	GLOBO OPAL	8W	230V	2200K	450	E27	90	SI	160	125	15000h	25 €

* Las medidas dadas son en milímetros

SERIE VELA

SERIE TUBULAR

SERIE LINEAL

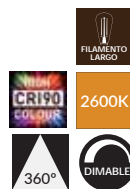
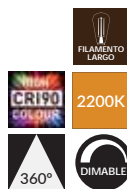
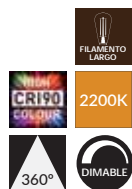

COD	MODELO	W	V	TC	LM	■	CRI	●	↗	○	🕒	PVR
42949	VELA	4W	230V	2200K	280	E14	90	SI	95	35	15000h	9,50 €
45971	TUBULAR	4,7W	230V	2200K	400	E27	90	SI	108	45	15000h	10 €
46107	LINEAL	8W	230V	2600K	800	R7s	90	SI	118	28	15000h	23,33 €

* Las medidas dadas son en milímetros

SERIE MAGNUM



COD	MODELO	W	V	TC	LM	■	CRI	●	↗	⊘	🕒	PVR
46152	MAGNUM	6W	230V	2200K	450	E27	90	SI	185	30	15000h	24 €

NEW

* Las medidas dadas son en milímetros

TWISTER



Edison
Black Smooth

Globo
Black Smooth

Globo

Alhambra

Softone

Plus

SERIE TWISTER LED

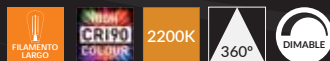

COD	MODELO	W	V	TC	LM	■	CRI	●	↗	⊘	🕒	PVR
51668	EDISON BLACK SMOOTH	4W	230V	2200K	100	E27	90	SI	135	60	15000h	18 €
51675	GLOBO BLACK SMOOTH	4W	230V	2200K	100	E27	90	SI	185	125	15000h	22 €
52078	GLOBO	4W	230V	2200K	180	E27	90	SI	185	125	15000h	21 €
51705	ALHAMBRA	4W	230V	2200K	180	E27	90	SI	140	95	15000h	20,50 €
51699	SOFTONE	4W	230V	2200K	180	E27	90	SI	100	60	15000h	19,50 €
51682	PLUS	4W	230V	2200K	180	E14	90	SI	130	45	15000h	19,50 €

* Las medidas dadas son en milímetros

≡ VINTAGE ≡

AMBAR

★ GOLDEN LED ★

1800K

DIMABLE

La gama Ambar Golden led ofrece una temperatura de color muy baja de 1800K y regulables.

El color característico y exclusivo de estas lámpara las hacen ser recomendadas en ambientes confortables y acogedores como restaurantes, cafeterías, hoteles, hogares, comercios, etc...

Disponibles en cuatro formatos distintos : Edison, Elipsoidal, Globo 125 mm y Globo 95 mm.



ELIPSOIDAL



EDISON



NEW VELA



GLOBO



MAXI GLOBO

VINTAGE AMBAR GOLDEN



1800K



COD	MODELO	W	V	TC	LM	☐	CRI	☉	↗	⊘	🕒	PVR
44929	ELIPSOIDAL	2,5W	230V	1800K	200	E27	80	SI	158	75	10000h	15,80 €
44899	EDISON	2,5W	230V	1800K	200	E27	80	SI	148	60	10000h	15,80 €
44905	GLOBO	2,5W	230V	1800K	200	E27	80	SI	135	95	10000h	15,80 €
44912	MAXI GLOBO	2,5W	230V	1800K	200	E27	80	SI	175	125	10000h	15,80 €
NEW 53099	VELA	4W	230V	1800K	200	E14	80	SI	100	35	15000h	14 €

* Las medidas dadas son en milímetros

DISEÑO EXCLUSIVO
E INNOVADOR

NEW



GOLDEN RING

Lámpara led de diseño exclusivo e innovador. Crea un ambiente único y de diseño con los nuevos modelos GOLDEN RING.

Efecto de luz nunca visto antes con temperatura de color 2.200K y regulable.



COD	MODELO	W	V	TC	LM	■	CRI	🕒	↕	⊙	🕒	PVR
52993	EDISON RING	8W	230V	2200K	440	E27	90	SI	155	68	15000h	22,50 €
52986	GLOBO RING	8W	230V	2200K	440	E27	90	SI	145	86	15000h	22,50 €

* Las medidas dadas son en milímetros

CABLES DE COLORES

Cable textil de 1,5 m de longitud.
Hasta 8 colores a elegir. Incluye
florón, cable y portalámparas E27.



COD	COLOR	↕	PVR
43236	●	1,5	15 €
43212	●	1,5	15 €
43229	●	1,5	15 €
43250	●	1,5	15 €

COD	COLOR	↕	PVR
43205	○	1,5	15 €
43267	●	1,5	15 €
43243	●	1,5	15 €
44431	●	1,5	15 €

* Las medidas dadas son en metros

GOLDEN CURVE

DIMABLE - 2200K

La gama GOLDEN CURVE led ofrece un diseño innovador y exclusivo.

La forma característica del filamento led hacen una solución perfecta para decorar cualquier espacio.

Con un alto índice de reproducción cromática y regulables.

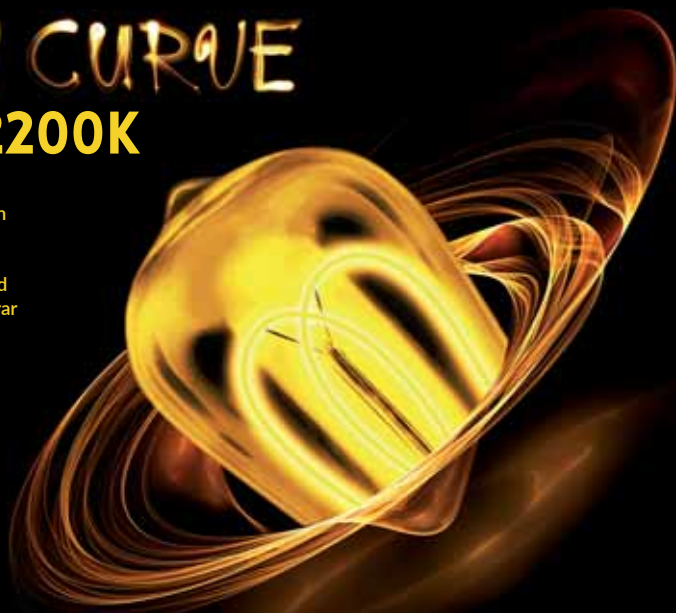

NEW



MINI EDISON



EDISON



GLOBO



COD	MODELO	W	V	TC	LM	—	CRI	●	↗	⊘	⌚	PVR
46442	MINI EDISON	2,7W	230V	2200K	120	E14	90	SI	108	45	15000h	13 €
46428	EDISON	4W	230V	2200K	200	E27	90	SI	135	60	15000h	17 €
46435	GLOBO	4W	230V	2200K	200	E27	90	SI	130	95	15000h	17,50 €

* Las medidas dadas son en milímetros



VIN AU VERRE
WINE BY THE GLASS

VIANCS & ROUGES

- MEURSAUX - CORDON ROUGE
- CREUZER - CORDON ROUGE
- CHATELAIN - CORDON ROUGE
- HUSCHARDT - CORDON ROUGE
- LOTS DE - CORDON ROUGE
- DURAS - CORDON ROUGE
- BICHES - CORDON ROUGE
- METSES - CORDON ROUGE
- ALSACE - CORDON ROUGE

VINTAGE GOLDEN TITAN

Descubre *TITAN*, la familia de lámparas led para sustituir las lámparas de sodio alta presión, baja presión y vapor mercurio. Mismo diseño elipsoidal con casquillo E27 y E40. Las lámparas *TITAN* pueden ser instaladas en cualquier posición y en luminarias para interior y exterior (IP44 y superior).

Para alumbrado vial y residencial o para crear ambientes acogedores en techos con altura en restaurantes, hoteles, paradores, castillos, salones de boda, etc...

Reproducción cromática CRI90, 100lm x watio, factor de potencia 0.92 y L70.

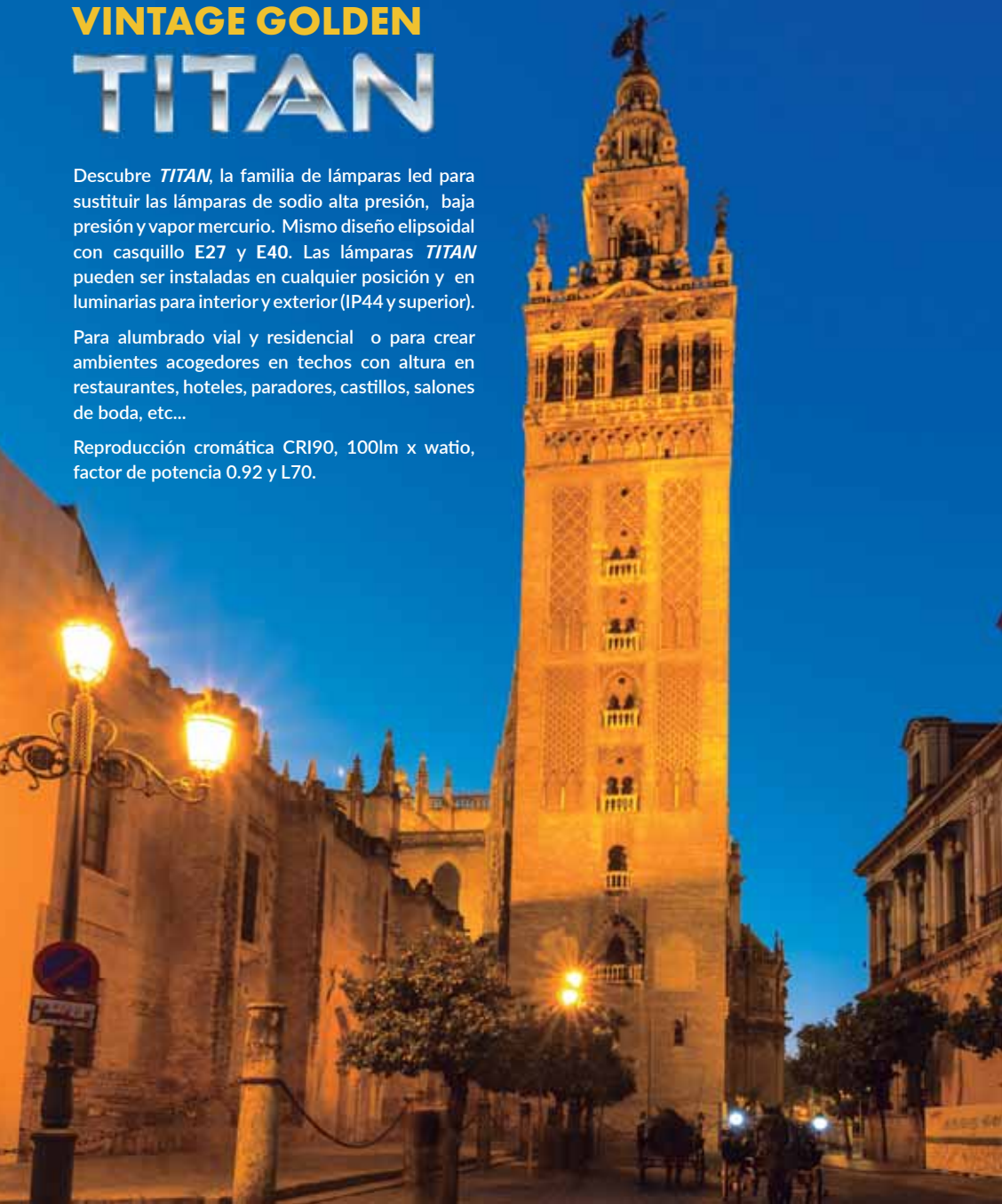

VINTAGE GOLDEN
TITAN

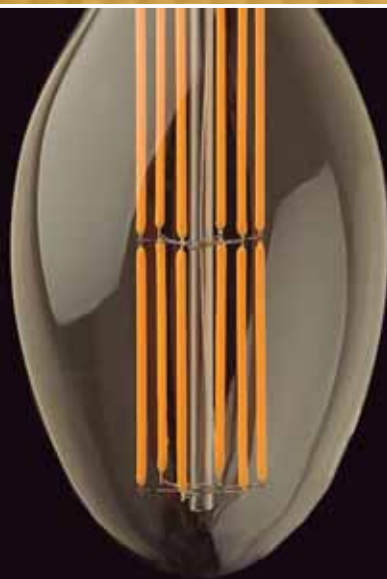

COD	W	V	TC	LM		CRI					PVR
53457	20W	230V	2200K	2000	E27	90	NO	225	90	15000h	52 €
53464	20W	230V	5600K	2000	E27	90	NO	225	90	15000h	52 €
53471	30W	230V	2200K	3000	E40	90	NO	290	118	15000h	68 €
53488	30W	230V	5600K	3000	E40	90	NO	290	118	15000h	68 €
53495	40W	230V	2200K	4000	E40	90	NO	290	118	15000h	88 €
53501	40W	230V	5600K	4000	E40	90	NO	290	118	15000h	88 €

* Las medidas dadas son en milímetros





360° STREET LAMP



COD	W	V	TC	LM	Base	CRI	Beam	Height	Width	Lifetime	PVR
42444	27W	110V-265V	4000K	3240	E27	80	NO	234	93	40000h	75 €
42451	27W	110V-265V	3000K	3240	E27	80	NO	234	93	40000h	75 €
42468	36W	110V-265V	4000K	4320	E27	80	NO	234	93	40000h	90 €
42475	36W	110V-265V	3000K	4320	E27	80	NO	234	93	40000h	90 €
42482	45W	110V-265V	4000K	5400	E27	80	NO	279	93	40000h	110 €
42499	45W	110V-265V	3000K	5400	E27	80	NO	279	93	40000h	110 €
42505	54W	110V-265V	4000K	6480	E40	80	NO	279	93	40000h	145 €
42512	54W	110V-265V	3000K	6480	E40	80	NO	279	93	40000h	145 €

* Las medidas dadas son en milímetros - Consultar otras potencias - Incluye cable de acero de seguridad - Consultar disponibilidad



REFLECTORAS
R50 - R63 - R80 - R90

CRI 80

120°

15,000

COD	MODELO	W	V	TC	LM	■	CRI	●	↗	○	⌚	PVR
★ 35989	R50	5W	230V	6500K	370	E14	80	NO	80	50	15000h	8 €
35996	R63	8W	230V	2800K	600	E27	80	NO	105	63	15000h	8 €
36009	R63	8W	230V	6500K	650	E27	80	NO	105	63	15000h	8 €
45544	R80	12W	230V	2800K	900	E27	80	NO	115	80	15000h	10 €
36016	R90	12W	230V	2800K	900	E27	80	NO	115	90	15000h	10 €
36023	R90	12W	230V	6500K	1000	E27	80	NO	115	90	15000h	10 €

* Las medidas dadas son en milímetros - ★ Últimas unidades



PAR 16 - COLORES



COD	W	V	TC	◻	▬	CRI	●	↗	⊘	⌚	PVR
43014	5W	230V	●	60°	GU10	80	NO	55	50	25000h	18 €
43007	5W	230V	●	60°	GU10	80	NO	55	50	25000h	18 €
42987	5W	230V	●	60°	GU10	80	NO	55	50	25000h	18 €
42994	5W	230V	●	60°	GU10	80	NO	55	50	25000h	18 €
43021	5W	230V	●	60°	GU10	80	NO	55	50	25000h	18 €

* Las medidas dadas son en milímetros



MR16 - COLORES



CRI
80

60°

25,000



COD	W	V	TC	△	■	CRI	●	↗	⊘	🕒	PVR
45032	5W	12V	●	60°	GU5.3	80	NO	50	50	25000h	18 €
45049	5W	12V	●	60°	GU5.3	80	NO	50	50	25000h	18 €
45025	5W	12V	●	60°	GU5.3	80	NO	50	50	25000h	18 €
45056	5W	12V	●	60°	GU5.3	80	NO	50	50	25000h	18 €
45063	5W	12V	●	60°	GU5.3	80	NO	50	50	25000h	18 €

* Las medidas dadas son en milímetros





BI-PIN G9
SILICONA



COD	W	V	TC	LM		CRI					PVR
42833	5W	230V	2700K	350	G9	80	NO	60	16	20000h	6,67 €
42840	5W	230V	4000K	350	G9	80	NO	60	16	20000h	6,67 €

* Las medidas dadas son en milímetros







 **TUBOS T8**
ESPECIAL ALIMENTACIÓN

Tubos de led para sustituir los tradicionales fluorescentes NATURA / GROLUX, con múltiples ventajas como:

- Ahorro energético de hasta 70%.
- Índice de reproducción cromática RA95.
- Mejora aspecto visible de los productos expuestos.
- Hasta 40.000 horas de vida.
- Compatible con reactancia magnética o directo a 230V.
- Conexión por los dos extremos.



COD	MODELO	W	V	TC	LM		CRI				PVR
42239	T8	8W	230V	●+○	300 - 400	G13	< 95	NO	60	40000h	24 €
42253	T8	16W	230V	●+○	800 - 900	G13	< 95	NO	120	40000h	35 €
42260	T8	22W	230V	●+○	1500 - 1700	G13	< 95	NO	150	40000h	42 €

* Las medidas dadas son en centímetros

TUBOS T8

LÁMPARAS

MM Electric



ECONOMY TUBO

CRISTAL

CRISTAL



CRI
80



	COD	MODELO	W	V	TC	LM	☐	CRI	⦿	↗	🕒	PVR
★	45131	T8	9W	230V	6500K	900	G13	80	NO	60	35000h	6 €
★	45148	T8	18W	230V	6500K	1800	G13	80	NO	120	35000h	10 €
★	45155	T8	28W	230V	6500K	2800	G13	80	NO	150	35000h	13 €

* Las medidas dadas son en centímetros - 🇪🇸 Últimas unidades

BASIC TUBO

GIRATORIO



CRI
80



	COD	MODELO	W	V	TC	LM	☐	CRI	⦿	↗	🕒	PVR
★	38225	T8	10W	230V	3000K	850	G13	80	NO	60	40000h	6 €
★	38232	T8	10W	230V	4000K	850	G13	80	NO	60	40000h	6 €
★	38256	T8	20W	230V	3000K	1700	G13	80	NO	120	40000h	10 €
★	38287	T8	25W	230V	3000K	2200	G13	80	NO	150	40000h	13 €
★	38294	T8	25W	230V	4000K	2200	G13	80	NO	150	40000h	13 €
★	38300	T8	25W	230V	5000K	2200	G13	80	NO	150	40000h	13 €

* Las medidas dadas son en centímetros - 🇪🇸 Últimas unidades



PAR 56
ESPECIAL PISCINAS

COD	W	V	TC	LM	CRI	☉	🕒	PVR
42116	18W - 21W	12V	6000K	-	80	NO	20000h	129,17 €
42222	18W - 21W	12V	RGB	-	80	NO	20000h	166,67 €

* Las medidas dadas son en milímetros - Incluye mando multifunción - Consultar disponibilidad



AR70 **NEW**

CREE



CRI 80

35°

25,000



COD	W	V	TC	LM	☐	CRI	☉	↗	🕒	🕒	PVR
51354	8W	12V	3000K	670	Ba15d	80	NO	53	70	25000h	34 €
51361	8W	12V	4000K	700	Ba15d	80	NO	53	70	25000h	34 €

* Las medidas dadas son en milímetros - Transformador electrónico recomendado cod:28622 página 274





LÁMPARAS



R7s

264



Linestra

264



Color Ball

265



LINEAL

COD	W	V	TC	LM		CRI				PVR
46350	4,5W	230V	3000K	470	R7s	80	NO	78	25000h	13 €
46343	8W	230V	3000K	810	R7s	80	NO	118	25000h	15 €

* Las medidas dadas son en milímetros



LINESTRA

COD	MODELO	W	V	TC	LM		CRI				PVR
46374	1 polo	5W	230V	2700K	300	S14s	80	NO	300	25000h	18,33 €
46367	2 polo	5W	230V	2700K	300	S14d	80	NO	300	25000h	18,33 €
46398	1 polo	8W	230V	2700K	500	S14s	80	NO	500	25000h	23,33 €
46381	2 polo	8W	230V	2700K	500	S14d	80	NO	500	25000h	23,33 €
46404	2 polo	16W	230V	2700K	1000	S14d	80	NO	1000	25000h	33,33 €

* Las medidas dadas son en milímetros



COLOR BALL

NEW



COD	REF. INT	W	V	TC	■	●	○	↗	🕒	PVR
55550	LM85310	4W	230V	●	E14	NO	45	78	15000h	5 €
55567	LM85311	4W	230V	●	E14	NO	45	78	15000h	5 €
55574	LM85312	4W	230V	●	E14	NO	45	78	15000h	5 €
55581	LM85313	4W	230V	●	E14	NO	45	78	15000h	5 €
55598	LM85314	4W	230V	●	E27	NO	45	77	15000h	5 €
55604	LM85315	4W	230V	●	E27	NO	45	77	15000h	5 €
55611	LM85316	4W	230V	●	E27	NO	45	77	15000h	5 €
55628	LM85317	4W	230V	●	E27	NO	45	77	15000h	5 €

* Las medidas dadas son en milímetros



Lumotech

Fulham es una compañía americana que se dedica al desarrollo de fuentes de alimentación y módulos LED. Los productos Fulham ofrecen una gran variedad de soluciones donde además podrás controlar la luz de forma inteligente.

La excelente calidad de sus fabricados y poseedor de las certificaciones de calidad

más exigentes dan la capacidad a Fulham de trabajar con una red de fabricantes y distribuidores de todo el mundo. Gracias a la apertura de su centro logístico y de diseño en Alkmaar (Países Bajos) podemos ofrecer un servicio técnico y de entrega ágil y eficiente en Europa.

DRIVER



Standar 268



Dimable 269



Dimable
DALI 269



Dimable
1-10V 270



Voltaje
constante 271



Kit de
Emergencia 272





STANDAR

Características

1. Input: AC100 - 240V; Output: DC3 - 60V.
2. Potencia: 6W - 40W.
3. IP20.

Aplicaciones

Downlights, Paneles, Luminarias de Carril, etc...

COD	MODELO	W	Input (V)	Output (V)	mA	PF	↗	PVR
52184	L05150	6W	100 - 240	3 - 16	350	0.98	46 x 42 x 22	12,10 €
52191	L05050	7W	100 - 240	3 - 12	700	0.98	46 x 42 x 22	12,10 €
52214	L05020-40250	11W	115 - 240	20 - 43	200/250	0.98	99 x 39 x 23	15,85 €
52221	L05020	12W	110 - 240	3 - 32	350/700	0.98	99 x 39 x 23	15,85 €
52252	L05020-390	12W	115 - 240	3 - 32	270/390	0.98	99 x 39 x 23	15,85 €
52269	L05020-500	12W	115 - 240	3 - 24	500/700	0.98	99 x 39 x 23	15,85 €
52276	L05020-40300	12W	115 - 240	20 - 43	180/300	0.98	99 x 39 x 23	15,85 €
52306	L05012	20W	115 - 240	3 - 33	350/1400	0.98	110 x 52 x 24	21,25 €
52313	L05013	20W	115 - 240	3 - 33	700	0.98	110 x 52 x 24	20,00 €
52535	L05013-1050	20W	115 - 240	3 - 19	1050	0.98	110 x 52 x 24	19,16 €
52542	L05013-1300	20W	115 - 240	3 - 17	1200	0.98	110 x 52 x 24	19,16 €
52559	L05013-48350	20W	115 - 240	3 - 48	350	0.98	110 x 52 x 24	17,50 €
52566	L05013-40500	20W	115 - 240	3 - 40	500	0.98	110 x 52 x 24	19,16 €
52610	L05032R	33W	180 - 240	15 - 48	500/1050	0.98	110 x 52 x 24	19,16 €
52627	L05033-48700	33W	220 - 240	30 - 48	700	0.98	110 x 52 x 24	17,50 €
52641	L05044	40W	160 - 240	15 - 32	300/1400	0.98	157 x 42 x 32	25,85 €
52672	L05049-601000-ND	40W	110 - 240	22 - 60	245/1050	0.98	157 x 42 x 32	23,75 €

* Las medidas dadas son en milímetros (Largo x Ancho x Alto)

DIMABLE, 1-10V, TRIAC POTENCIÓMETRO



Características

1. Input: AC220 - 240V; Output: DC3 - 43V.
2. Potencia: Max. 25W.
3. Dimable 1-10V y Dimable con potenciómetro.
4. Selección de corriente por interruptor DIP
4. IP20.

Aplicaciones

Lámparas, Downlights, Paneles, Luminarias de Carril, etc...

COD	MODELO	W	Input (V)	Output (V)	mA	PF	↗	PVR
53563	L05023-A	25W	220 - 240	3 - 43	100-1050	0.98	99 x 39 x 23	37 €

* Las medidas dadas son en milímetros (Largo x Ancho x Alto)



DIMABLE

Características

1. Input: AC220 - 240V; Output: DC20 - 40V.
2. Potencia: 10W - 12W.
3. Dimable Trailing Edge.
4. IP20.

Aplicaciones

Downlights, Paneles, Luminarias de Carril, etc...

COD	MODELO	W	Input (V)	Output (V)	mA	PF		PVR
52207	L05021-40250	10W	220 - 240	20 - 40	200/250	0.98	99 x 39 x 23	16,66 €
52238	L05021	12W	220 - 240	3 - 32	350/700	0.98	99 x 39 x 23	16,25 €
52283	L05021E	12W	220 - 240	3 - 32	350/700	0.98	99 x 39 x 23	16,25 €
52290	L05021-40300	12W	220 - 240	20 - 40	180/300	0.98	99 x 39 x 23	16,66 €

* Las medidas dadas son en milímetros (Largo x Ancho x Alto)



DIMABLE DALI

Características

1. Input: AC180 - 240V; Output: DC7 - 55V.
2. Potencia: 30W - 40W.
3. Dimable DALI.
4. IP20.

Aplicaciones

Downlights, Paneles, Luminarias de Carril, etc...

COD	MODELO	W	Input (V)	Output (V)	mA	PF		PVR
52597	L05025	30W	180 - 240	7 - 43	100/1000	0.98	157 x 42 x 32	30,00 €
52634	L05040	40W	180 - 240	7 - 55	100/1000	0.98	157 x 42 x 32	36,66 €

* Las medidas dadas son en milímetros (Largo x Ancho x Alto)

DIMABLE 1-10V

DRIVER LED | INDOOR

FULHAM
Lighting... Global. Intelligent. Sustainable.

MADE IN POLAND



DIMABLE 1-10V

Características

1. Input: AC110 - 240V; Output: DC3 - 60V.
2. Potencia: 20W - 100W.
3. Dimable 1-10V.
4. IP20.

Aplicaciones

Downlights, Paneles, Luminarias de Carril, etc...

COD	MODELO	W	Input (V)	Output (V)	mA	PF	↗	PVR
52320	L05016Ci	20W	110 - 240	3 - 43	110/500	0.98	110 x 52 x 24	24,16 €
-	L05016CiD	20W	110 - 240	3 - 43	1C: 200/600 2C: 100/300	0.98	110 x 52 x 24	-
52337	L05016i	20W	110 - 240	3 - 33	110/500	0.98	110 x 52 x 24	24,16 €
52351	L05011i2	20W	180 - 240	6 - 42	100/1200	0.98	110 x 52 x 24	25,85 €
52580	L05011i3	24W	180 - 240	6 - 42	20W: 200/1200 24W: 600/900	0.98	110 x 52 x 24	25 €
52603	L05031	30W	180 - 240	6 - 43	100/1400	0.98	110 x 52 x 24	30 €
52658	L05045	40W	110 - 240	15 - 32	300/1400	0.98	157 x 42 x 32	26,66 €
52665	L05049-601000	40W	110 - 240	22 - 60	245/1050	0.98	157 x 42 x 32	24,15 €
52689	L05055	60W	220 - 240	18 - 60	245/2000	0.98	157 x 42 x 32	35 €
52474	L05059	60W	220 - 240	18 - 60	280/1400	0.98	157 x 42 x 32	33,10 €
52696	L05060	100W	110 - 240	20 - 60	350/2800	0.98	212 x 76 x 46	66,66 €

* Las medidas dadas son en milímetros (Largo x Ancho x Alto)



VOLTAJE COSTANTE

Características

1. Input: AC110 - 240V; Output: DC3 - 60V.
2. Potencia: 20W - 100W.
3. Dimable 1-10V.
4. IP20.

Aplicaciones

Downlights, Paneles, Luminarias de Carril, etc...

COD	MODELO	W	Input (V)	Output (V)	DIMABLE	mA	PF	↗	PVR
52344	L05011i	20W	180 - 240	3 - 33	1-10V	0/1000	0.98	110 x 52 x 24	25,85 €
52351	L05011i2	20W	110 - 240	6 - 42	1-10V	100/1200	0.98	110 x 52 x 24	25,85 €
52702	L05032-24CV1050	32W	110 - 240	24	POTENCIO- METRO	0/1050	0.98	110 x 52 x 24	20 €
52719	L05046	36W	110 - 240	24	NO	0/1500	0.98	157 x 42 x 32	22,50 €
52726	L05058-24CV2000	48W	220 - 240	24	NO	245/2000	0.98	157 x 42 x 32	33,33 €

* Las medidas dadas son en milímetros (Largo x Ancho x Alto)

GAMA DE PRODUCTOS *FULHAM*



KIT DE EMERGENCIA

DRIVER LED | INDOOR

FULHAM
Lighting... Global. Intelligent. Sustainable.

MADE IN POLAND



NEW

FULHAM
HOTSPOT LED™



DRIVER EMERGENCIA PARA LUMINARIAS LED

El revolucionario HotSpot Plus LED Driver & Emergency System combina las funciones de un controlador de LED programable y regulable, un controlador de LED de emergencia y una batería de respaldo reemplazable en una sola unidad compacta.

En condiciones normales, esta solución todo en uno funciona como un controlador de corriente constante de 40/45 W; durante un corte de energía, la batería integrada se activa automáticamente, proporcionando 5 W de potencia durante 180 minutos o 10 W durante 90 minutos *. Los beneficios incluyen costos más bajos, instalación simplificada y la capacidad de llevar la capacidad de LED de emergencia a luminarias más pequeñas.

COD	MODELO	W	Input (V)	Output (V)	mA	PF	↗	PVR
53556	FHSAC1-230-45CE	58W	220 - 240	11 - 50	250/1400	0.90	200 x 82 x 34	128 €

* Las medidas dadas son en milímetros (Largo x Ancho x Alto)



CARACTERÍSTICAS

- Controlador LED integrado, controlador LED de emergencia y batería reemplazable
- Oscurecimiento 0-10V (100% -1%)
- Potencia de emergencia: 5 W durante 180 min o 10 W durante 90 min (seleccionable por el usuario). Versión europea: salida de emergencia 1W-6W; fábrica configurada para 3W por 180 min.
- Corriente de salida programable: 250-1400mA en incrementos de 1mA
- Compatible con la plataforma de programación Fulham SmartSet
- Interruptor de prueba iluminado / indicador de alimentación de CA
- Autodiagnóstico conmutable
- Garantía: 5 años a TC máx. 70 ° C. 3 años para la batería -C y -BLS a TC máx. 80 ° C

Controlador SmartSet



Software SmartSet

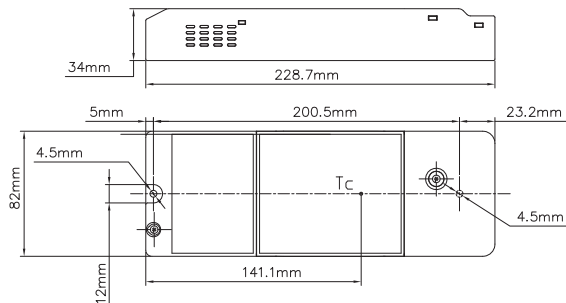

FULHAM
HOTSPOT LED™



Kit de emergencia tradicional

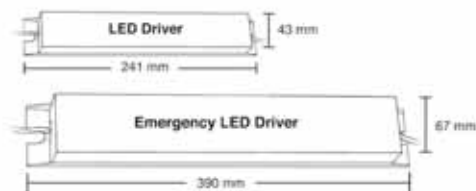



LUMINARIAS

PANTALLA MX

COD	W	TC	ACABADO	PVR
18333	2 X 21W	-	T5	41,67 €



PANTALLA ULTRA SLIM

COD	W	TC	ACABADO	PVR
18180	16W	3500K	T4	13,33 €
18197	16W	6400K	T4	13,33 €
18210	20W	6400K	T4	14,58 €



PANTALLA SUNLIT

COD	W	TC	ACABADO	PVR
06224	15W	4200K	T8	12,50 €
06132	13W	6400K	T5	13,33 €



TANSFORMADORES

ELECTRÓNICO 12V

COD	W	Input (V)	Output (V)	A	PVR
28622	0 - 60W	230V	11,5V	0,27A	7,25 €

* Funciona con lámparas Led y halógenas



LUXIA LED

ELECTRÓNICO 12V



COD	DESCRIPCIÓN	W	Input (V)	Output (V)	A	PVR
03797	ELECTRÓNICO 12V	0 - 60W	230V	11,5 V	5A	21,67 €
38553	ELECTRÓNICO 12	0 - 105W	230V	11,5 V	5A	30 €

* Funciona con lámparas Led y halógenas

00185	137	03483	136	27243	91	36016	255
00192	137	03537	136	27809	91	36023	255
00284	137	03568	136	28516	112	36108	155
00291	137	03599	136	28622	274	36115	155
00307	137	03612	136	28660	102	36122	155
00314	137	03629	136	29322	92	36153	156
00390	137	03636	136	29476	138	36177	153
00406	137	03681	136	30007	92	36214	153
00482	138	03704	136	30045	92	36238	160
00550	138	03711	136	30076	92	36245	160
00574	138	03728	136	30083	92	36252	160
00642	138	03735	136	30144	112	36269	161
00895	138	03742	136	32995	228	36276	161
00901	138	03759	136	33008	228	36283	158
00949	138	03797	274	33015	88	36290	158
01090	138	06132	274	33022	88	36306	158
01113	138	06224	274	33039	88	36313	158
01304	138	06927	139	33046	88	36320	159
01335	138	06934	139	33152	117	36337	159
01458	137	06958	28	33169	117	36344	159
01502	137	06965	28	33176	117	36368	165
01519	137	06972	28	33206	118	36382	165
01526	137	07009	51	33275	123	36399	165
01557	137	07016	51	33329	114	36412	26
01571	137	07023	51	33336	114	36429	26
01601	137	07030	51	33343	127	36436	26
01687	137	07092	138	33381	125	36498	117
01816	138	18180	274	33978	128	36504	117
01861	139	18197	274	33985	128	36542	92
01885	139	18210	274	33992	59	36665	115
01915	139	18333	274	34005	59	36672	115
02004	120	20343	63	34050	78	36702	80
02011	120	20367	51	34067	78	36719	20
02028	139	20374	51	34302	93	36726	20
02059	139	22026	43	34463	106	36917	127
02066	139	22033	43	34630	127	36979	153
02202	139	22088	138	34647	129	37129	155
02127	139	22460	138	34654	129	37709	161
02134	139	22552	136	34661	62	37747	162
02141	139	22613	136	35286	228	37754	162
02172	139	22620	136	35293	228	37778	162
02219	139	22637	136	35330	88	37808	162
02257	139	22699	103	35354	88	38096	159
02318	79	23009	102	35361	59	38102	159
02424	27	23931	112	35378	59	38201	113
02431	27	24198	102	35385	59	38218	228
02455	50	24303	112	35392	59	38225	260
02462	50	24310	139	35422	62	38232	260
02929	139	24327	139	35811	128	38256	260
02936	139	25119	228	35828	128	38287	260
02981	138	25126	228	35873	126	38294	260
02998	138	25133	228	35880	126	38300	260
03001	138	26833	103	35897	126	38348	113
03049	138	27014	63	35989	255	38355	20
03070	138	27137	63	35996	255	38362	20
03247	139	27229	91	36009	255	38379	20

ÍNDICE NÚMÉRICO

38386	20	42239	259	43090	93	43892	183
38553	274	42253	259	43106	93	43908	183
38652	88	42260	259	43120	133	43915	183
38683	32	42277	223	43137	133	43939	185
38690	32	42307	223	43144	133	43946	185
38720	33	42314	227	43151	133	43953	185
38737	33	42321	227	43175	82	43960	185
38744	33	42338	227	43205	249	43977	185
38751	33	42345	227	43212	249	43984	185
38768	33	42352	131	43229	249	43991	185
38836	236	42369	131	43236	249	44004	185
38843	236	42376	120	43243	249	44011	185
38850	236	42406	119	43250	249	44035	228
38867	236	42413	119	43267	249	44042	228
38874	236	42420	127	43274	223	44059	228
38881	236	42444	254	43281	223	44066	228
38898	236	42451	254	43298	223	44073	228
38904	236	42468	254	43304	232	44080	228
39055	228	42475	254	43311	232	44097	228
39093	76	42482	254	43328	232	44103	228
39154	129	42499	254	43342	233	44110	228
39161	129	42505	254	43359	232	44127	228
39314	157	42512	254	43366	232	44196	123
39444	163	42550	225	43373	232	44219	109
39512	163	42567	225	43380	233	44226	117
39529	163	42581	225	43434	182	44233	117
41201	223	42598	225	43441	182	44271	229
41218	223	42611	44	43458	182	44288	229
41416	60	42628	44	43465	182	44318	229
41423	61	42635	36	43472	182	44325	229
41430	61	42642	36	43489	182	44400	229
41447	61	42659	37	43519	182	44417	229
41621	102	42666	37	43526	182	44424	229
41638	102	42673	126	43533	182	44431	249
41645	103	42741	118	43540	182	44790	228
41652	103	42802	224	43557	182	44806	228
41669	134	42833	258	43564	182	44813	228
41676	134	42840	258	43571	182	44837	224
41683	134	42871	223	43588	182	44844	223
41713	134	42888	224	43595	182	44851	223
41720	134	42895	224	43601	182	44875	107
41768	130	42901	224	43618	182	44899	248
41775	130	42918	224	43625	182	44905	248
41782	130	42949	246	43632	182	44912	248
41799	130	42956	245	43649	182	44929	248
41805	130	42963	246	43656	182	44936	223
41812	130	42970	245	43663	182	44943	223
41935	226	42987	256	43670	182	45025	257
41959	226	42994	256	43687	182	45032	257
41966	118	43007	256	43694	182	45049	257
42079	223	43014	256	43816	183	45056	257
42086	223	43021	256	43823	183	45063	257
42093	224	43045	124	43830	183	45131	260
42109	224	43052	125	43854	183	45148	260
42116	261	43069	131	43861	183	45155	260
42222	261	43083	93	43878	183	45223	237

45230	237	46121	246	46794	22	50616	81
45247	237	46138	246	46800	22	50623	81
45254	237	46145	245	46817	22	50630	81
45261	237	46152	247	46824	22	50647	81
45278	237	46183	115	46831	38	50654	81
45285	237	46190	120	46848	38	50661	81
45292	237	46206	109	46855	38	50678	81
45308	237	46213	109	46862	38	50685	81
45315	237	46220	120	46879	38	50692	81
45322	237	46237	108	46886	38	50708	81
45339	237	46244	108	46893	38	50715	81
45421	237	46251	128	46909	38	50722	83
45438	237	46268	113	46916	38	50760	113
45445	237	46275	113	46923	39	50784	109
45452	237	46299	125	46930	39	50791	109
45469	232	46312	109	46947	39	50814	109
45476	232	46336	60	46954	89	51002	223
45513	233	46343	264	46961	89	51019	223
45520	232	46350	264	46978	89	51026	223
45537	233	46367	264	46985	89	51033	223
45544	255	46374	264	46992	89	51064	227
45568	127	46381	264	47005	89	51071	227
45575	117	46398	264	47012	89	51149	230
45582	117	46404	264	47029	89	51156	230
45599	117	46428	250	47036	89	51170	230
45605	123	46435	250	47043	89	51187	230
45612	123	46442	250	47050	89	51200	32
45629	126	46473	40	47067	89	51279	33
45636	126	46480	40	47074	89	51286	33
45643	123	46503	40	47081	89	51354	261
45650	123	46510	47	47098	53	51361	261
45667	92	46527	47	47104	53	51415	110
45674	123	46534	47	47111	53	51422	108
45681	130	46541	47	47128	53	51439	108
45698	130	46558	31	47142	83	51446	22
45704	130	46565	31	47166	83	51453	120
45759	93	46572	31	47180	83	51460	113
45773	117	46589	31	47227	83	51491	228
45797	119	46596	52	50425	20	51507	228
45827	123	46602	52	50432	39	51507	228
45834	123	46619	52	50449	39	51514	228
45841	123	46626	52	50456	39	51538	100
45858	123	46633	133	50463	39	51545	100
45865	110	46657	123	50470	39	51552	108
45872	110	46664	120	50487	39	51569	110
45902	226	46671	128	50500	60	51576	110
45926	223	46688	113	50517	64	51583	110
45933	223	46695	125	50524	64	51590	95
45940	227	46701	123	50531	64	51606	95
45957	227	46718	123	50548	69	51613	95
45971	246	46725	123	50555	69	51620	95
46077	245	46749	131	50562	69	51637	95
46084	245	46756	131	50579	69	51644	95
46091	245	46763	22	50586	69	51651	75
46107	246	46770	22	50593	69	51668	247
46114	246	46787	22	50609	81	51675	247

ÍNDICE NÚMÉRICO

51682	247	52504	227	53297	58	54041	235
51699	247	52511	227	53303	127	54058	235
51705	247	52528	227	53310	119	54065	67
51743	109	52535	268	53327	119	54232	184
51750	109	52542	268	53334	95	54249	185
51767	183	52559	268	53341	95	54256	184
51774	183	52566	268	53358	95	54263	184
51781	183	52580	270	53365	95	54270	185
51804	183	52597	269	53372	95	55000	184
51811	183	52603	270	53389	95	55017	184
51828	183	52610	268	53396	131	55024	184
51842	183	52627	268	53402 + 53440	240	55031	184
51859	183	52634	269	53402	241	55048	184
51866	183	52641	268	53419 + 53440	240	55055	184
51897	183	52658	270	53419	241	55062	184
52009	182	52665	270	53426 + 53440	240	55079	184
52016	182	52672	268	53426	241	55093	185
52023	182	52689	270	53433 + 53440	240	55109	185
52030	182	52696	270	53433	241	55116	185
52047	182	52702	271	53457	251	55123	185
52054	182	52719	271	53464	251	55130	185
52061	182	52726	271	53471	251	55314	243
52078	247	52757	99	53488	251	55321	243
52184	268	52764	99	53495	251	55345	191
52191	268	52771	119	53501	251	55352	189
52207	269	52788	119	53525	79	55369	193
52214	268	52801	123	53556	272	55376	193
52221	268	52818	123	53563	268	55383	193
52238	269	52825	75	53570	56	55390	198
52252	268	52986	249	53587	56	55406	198
52269	268	52993	249	53594	56	55413	198
52276	268	53013	245	53600	56	55420	198
52283	269	53037	184	53617	56	55437	194
52290	269	53044	33	53624	56	55444	194
52306	268	53051	106	53631	56	55451	194
52313	268	53068	106	53648	103	55468	194
52320	270	53075	106	53655	104	55475	199
52337	270	53082	106	53662	65	55482	199
52344	271	53099	248	53679	65	55499	195
52351	270	53105	106	53686	85	55505	195
52351	271	53112	106	53693	85	55512	195
52368	42	53129	58	53723	126	55529	200
52375 + 47241	24	53136	58	53730	127	55536	200
52375 + 47395	24	53143	58	53761	108	55543	200
52375 + 47425	24	53150	58	53778	228	55550	265
52382 + 47258	24	53167	58	53785	228	55567	265
52382 + 47401	24	53174	58	53808	242	55574	265
52382 + 47432	24	53204	58	53815	242	55581	265
52405	77	53211	58	53822	242	55598	265
52412	77	53228	58	53839	242	55604	265
52429	77	53235	58	53846	242	55611	265
52443	67	53242	58	53853	104	55628	265
52450	124	53259	58	53860	41	55635	142
52467	131	53266	58	53877	41	55642	142
52474	270	53273	58	53884	41	55659	144
52498	227	53280	58	53891	246	55666	143

55673	143	56458	210	57066	205	57639	213
55680	145	56465	210	57073	205	57653	213
55697	145	56472	210	57080	205	57660	213
55703	147	56489	211	57097	205	57677	213
55710	147	56496	211	57103	205	57684	214
55727	147	56502	212	57110	205	57691	214
55734	147	56519	212	57127	205	57707	214
55741	146	56526	212	57134	205	57714	214
55758	146	56533	212	57141	205	57721	214
55826	67	56540	212	57158	206	57738	214
55918	198	56557	212	57165	206	57745	214
55925	197	56564	212	57172	206	57752	214
55932	197	56571	212	57189	207	57769	214
55949	197	56588	213	57196	207	57776	215
55956	197	56595	213	57202	207	57783	215
55963	197	56601	213	57219	207	57790	215
55970	197	56618	213	57226	207	57806	215
55987	197	56625	213	57233	207	57813	215
55994	197	56632	213	57240	207	57820	217
56007	199	56649	213	57257	207	57837	216
56014	199	56656	213	57264	207	57844	216
56021	199	56663	213	57271	209	57851	216
56038	199	56670	214	57288	209	57868	216
56045	199	56687	214	57295	209	57875	216
56052	199	56717	215	57301	209	57882	217
56069	200	56724	215	57318	209	57899	217
56144	205	56731	215	57325	209	57905	217
56151	205	56748	215	57332	209	57912	217
56168	205	56755	215	57349	209	57936	217
56175	205	56762	216	57356	209	57943	205
56182	205	56779	216	57363	209	57950	205
56199	205	56793	216	57370	209	57967	205
56205	206	56806	216	57387	209	57974	205
56212	206	56809	217	57394	209	57981	205
56229	206	56816	217	57400	209	57998	205
56236	206	56823	215	57417	210	58001	205
56243	206	56830	215	57424	210	58018	205
56250	206	56847	215	57431	210	58025	205
56267	206	56854	215	57448	211	58032	205
56274	207	56861	215	57455	211	58049	209
56281	207	56878	217	57462	211	58056	209
56298	207	56885	217	57479	211	58063	209
56304	207	56915	205	57486	211	58070	209
56311	207	56922	205	57493	211	58087	209
56328	207	56939	209	57509	211	58094	209
56335	207	56946	209	57516	211	58100	209
56342	207	56953	209	57523	211	58117	209
56359	207	56960	209	57530	211	58124	209
56366	207	56977	209	57547	211	58131	209
56373	207	56984	209	57554	211	58148	57
56380	207	56991	217	57561	211	58155	57
56397	209	57004	217	57578	211	58162	97
56403	209	57011	205	57585	211	58179	97
56410	210	57028	205	57592	211	58223	110
56427	210	57035	205	57608	212		
56434	210	57042	205	57615	212		
56441	210	57059	205	57622	212		

CONDICIONES GENERALES

MEGAMAN ELÉCTRICA



CONDICIONES GENERALES DE VENTA Y SUMINISTRO MEGAMAN ELÉCTRICA S.A.

1 OFERTAS

Nuestras ofertas, bien sean escritas u orales, se entienden que son a título informativo y sin compromiso de aceptación por ninguna de las partes, salvo que se pactara lo contrario.

2 PEDIDOS

Los pedidos realizados por los clientes serán aceptados mediante documento firmado, correo electrónico, fax, telefónicamente o enviados a nuestra red de ventas identificando con número de pedido, firma y sello.

Los pedidos serán aceptados bajo este procedimiento. En caso de modificación o anulación de pedido deberá efectuarse en el plazo legal antes de la salida de la mercancía.

3 SUMINISTRO

Los pedidos que con valor neto superen los 350€ serán entregados a portes pagados en Península.

Los pedidos que con valor neto superen los 750€ serán entregados a portes pagados en Islas Baleares.

Los pedidos que con valor neto superen los 1000€ serán entregados a portes pagados en Islas Canarias, Ceuta y Melilla.

Los pedidos que no superen este valor neto, se podrá hacer entrega de ellos con cargo a portes debidos o bajo autorización expresa de nuestro cliente quien indicará el nombre y forma de la compañía que se hará cargo de la mercancía en cuestión.

La mercancía que viaje a portes pagados bajo las agencias de transporte autorizadas será responsabilidad de Megaman Eléctrica S.A. tanto de su estado como de su entrega.

La mercancía que viaje a cuenta de el cliente correrá bajo su responsabilidad desde el mismo momento que se hiciera cargo de la mercancía o desde el mismo momento de su salida de las instalaciones.

El envío de mercancía para demostraciones o muestras serán enviadas bajo autorización expresa a portes pagados si así se requiere en cada caso.

Se podrá hacer suministro de cualquier cantidad o número de unidades.

4 GARANTÍAS

Los productos marcados con un distintivo de garantía tendrá una validez desde el mismo momento de la compra hasta el cumplimiento del plazo de garantía. Aquellos artículos donde no figure el distintivo de garantía tendrán una validez de dos años ya sea por la naturaleza de su construcción o por una fuente de alimentación externa cuya vida útil es muy inferior a la vida de la fuente de luz led. En cualquiera de los casos la garantía de los artículos led se basan en 4.000 horas de uso anual como regla estándar marcada por el fabricante.

En el caso de solicitar un servicio de garantía extendida póngase en contacto en ventas@megamanelectrica.com.

5 PLAZOS

Los plazos de entrega de material siempre serán considerados aproximados y no podrá exigirse responsabilidad a causa de retrasos por fuerza mayor u otras circunstancias ajenas a la voluntad de Megaman Eléctrica S.A., no dando derecho al comprador a indemnizaciones ni anulaciones en los pagos por pedidos realizados.

6 PAGOS

Se efectuarán según la ley vigente en cada momento. En caso de demora en los pagos, se cargará al comprador el interés correspondiente, así como cualquier gasto de renovación o aplazamiento si lo hubiere. Queda reservada por parte de Megaman Eléctrica la facultad de fijar el límite o cuantía de máxima de crédito a conceder, así como de suspender el suministro en el caso de tener el cliente pagos atrasados.

7 DEVOLUCIONES

No se admitirán devoluciones de material sin previa solicitud por escrito de el cliente y bajo aprobación por parte de Megaman Eléctrica. Para realizar la devolución deberá ser necesario indicar producto, cantidad, número de albarán y la fecha.

No se admitirán devoluciones de mercancía descatalogada, usada, en malas condiciones físicas o de los embalajes, fabricada o solicitada en expreso por el cliente.

No se admitirán devoluciones de mercancía pasados 10 días desde el momento de la entrega.

La devolución de la mercancía supondrá una depreciación del 20% en concepto de gastos de administración y manipulación de la mercancía.

Megaman Eléctrica S.A. no se hará cargo de las devoluciones que no sean remitidas a portes pagados. Salvo autorización de la empresa.

En los casos que el comprador acredite un defecto técnico en la mercancía, será necesario la comprobación y evaluación que confirme el fallo en el producto y no por motivos de manipulación, instalación o uso indebido. En los casos que resulte producto con fallo técnico Megaman Eléctrica S.A. procederá a el abono o sustitución gratuita de el material adquirido.

8 JURISDICCIÓN

Para cualquier discrepancia o litigio que se derive de las citadas Condiciones Generales de Venta, ambas partes se someten a la competencia de los Juzgados y Tribunales de Madrid.

9 PRECIOS

Los precios son de VENTA AL PÚBLICO (Recomendados) y pueden ser modificados sin previo aviso. Los precios no incluyen IVA.

Los precios vigentes no incluyen el efecto en el coste de los gastos medioambientales previstos en la directiva sobre residuos de aparatos eléctricos y electrónicos (raee).



www.megamanelectrica.com

ILUMINANDO DESDE 1981

Distribuidor:



Megaman Eléctrica. Impreso en España. 10 - 2018.

Toda la información puede ser susceptible de cambios sin previo aviso.