

# CATALOGUE 2024

NOVOLUX LIGHTING

C/ Ramon Berenguer, 8 (Pol. Ind. Can Vinyals)

08130 Santa Perpètua de Mogoda, Barcelona, Spain.

ESPANA – PORTUGAL: Tel. +34 93 274 52 52 – [info@novoluxlighting.com](mailto:info@novoluxlighting.com)

EXPORT: Tel. +34 93 516 20 25 – [export@novoluxlighting.com](mailto:export@novoluxlighting.com)

FRANCE: Tel. +34 93 516 20 25 – [france@novoluxlighting.com](mailto:france@novoluxlighting.com)

[www.novoluxlighting.com](http://www.novoluxlighting.com)





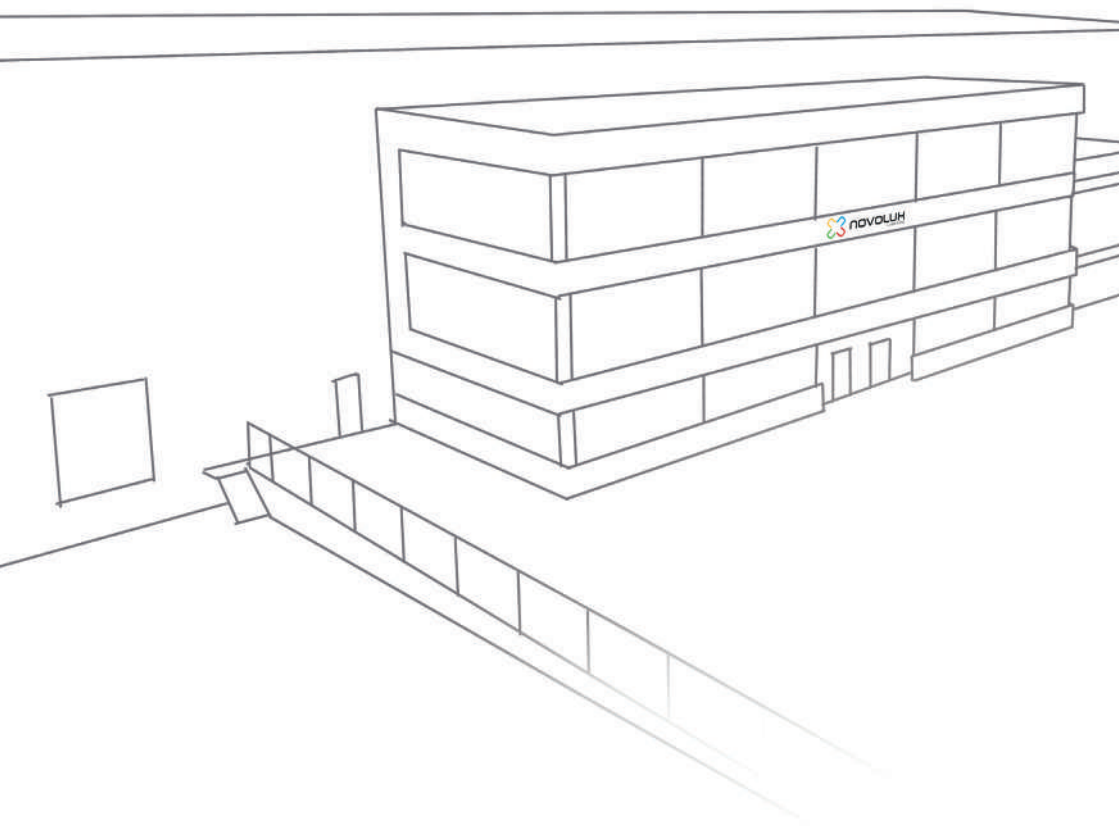

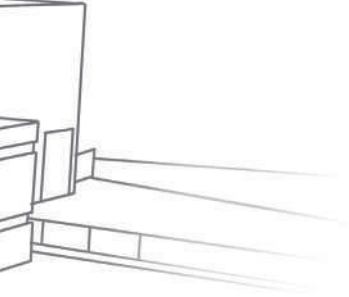

## Somos Novolux Lighting

En Novolux Lighting fabricamos y comercializamos una amplia gama de luminarias de calidad desde 1981, ofreciendo actualmente soluciones globales de iluminación para aplicaciones luminicas de interior y de exterior.

Con sede central en Barcelona y una sólida red de partners y distribuidores locales establecida en Europa, Oriente Medio, Latinoamérica, África y Asia, tenemos presencia internacional en más de 40 países.

## We are Novolux Lighting

Novolux Lighting has been manufacturing and commercialising a wide range of high-quality luminaires since 1981 and, nowadays, it offers global lighting solutions for indoor and outdoor lighting applications.

With headquarters in Barcelona and a strong network of local distributors and partners established in Europe, the Middle East, Latin America, Africa and Asia, the company has a worldwide presence in more than 40 countries.

# Nuestras gamas

## Our product lines



## indeluz

Luminarias técnicas de uso interior pensadas específicamente para espacios comerciales, hoteleros y oficinas.

Technical indoor luminaires specifically designed for shops, malls, hotels and offices.

## exo

Luminarias versátiles y decorativas de uso interior con enfoque a hospitality y contract.

Versatile and decorative indoor luminaires focused on hospitality and contract.

## Dopo

Luminarias de carácter funcional para todo tipo de aplicaciones de exterior.

Functional luminaires for all types of outdoor applications.

## Cristher

Luminarias de alta gama para exteriores residenciales y arquitecturales.

High range luminaires for residential and architectural outdoor settings.

## CANALED

SMART LIGHTING

Soluciones lineales de uso interior para grandes superficies comerciales, aparcamientos, fábricas, almacenes y centros logísticos, infraestructuras ferroviarias y oficinas.

Linear modular lighting solutions of a technical-industrial purpose for indoor use in shopping malls, parking areas, factories, warehouses and logistics hubs, railway infrastructures and offices.

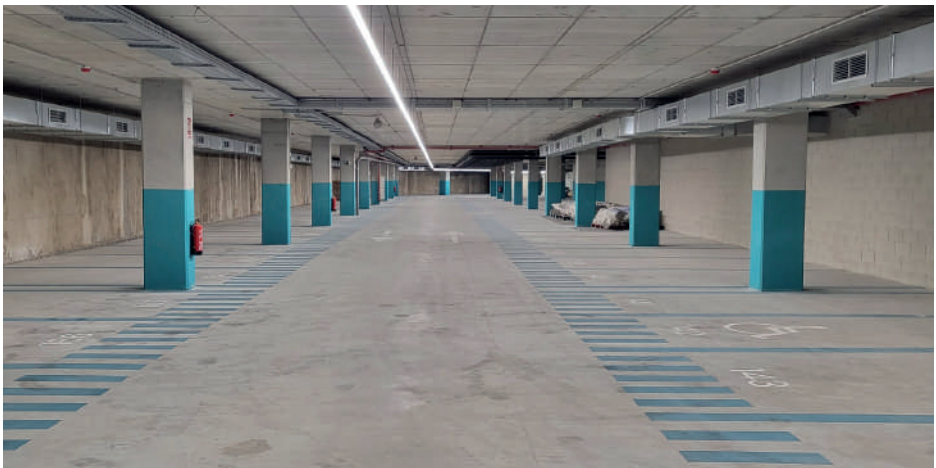
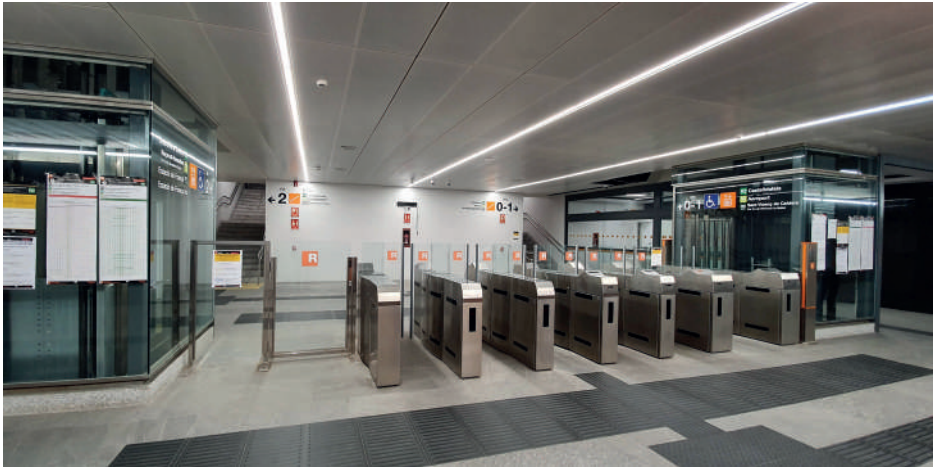

# Gama Canaled

En Canaled somos especialistas en iluminación lineal para grandes superficies comerciales, aparcamientos, fábricas, almacenes y centros logísticos, infraestructuras ferroviarias y oficinas desde 2011. Durante los primeros diez años de existencia, en Canaled hemos instalado más de 150.000 metros de iluminación lineal en varios países del mundo y para compañías como Amazon, Carrefour, Lidl, Decathlon, Renfe, Adif, HP, Seat, FNAC, SABA, etc. Estamos integrados dentro de Novolux Lighting desde enero de 2023.

En Canaled basamos nuestra estrategia en la elevada calidad y fiabilidad del producto, la utilización de tecnología de última generación y la innovación continua. También son elementos claves la fabricación km0 y la colaboración con proveedores de proximidad. Con el objetivo de reducir la huella ecológica a la vez que los costes económicos, proponemos una gama de productos de iluminación de bajo consumo y de bajo coste gracias a su fácil fabricación, instalación y mantenimiento.

# Range Canaled

Since 2011, Canaled has specialised in linear lighting for large shopping centres, car parks, factories, warehouses and logistics centres, railway infrastructures and offices. Canaled has installed more than 150.000 metres of linear lighting in various countries around the world during its first ten years of operation for companies such as Amazon, Carrefour, Lidl, Decathlon, Renfe, Adif, HP, Seat, FNAC, SABA, etc. We are integrated in Novolux Lighting since January 2023.

Our strategy at Canaled is based on high product quality and reliability, the usage of state-of-the-art technology and continuous innovation. Some other key elements are km0 manufacturing and collaboration with local suppliers. We offer a range of energy-saving and low-cost lighting products designed for easy manufacture, installation and maintenance, in order to reduce the ecological footprint as well as economic costs.









# Cultura de la luz

En Novolux Lighting estamos vinculados a varias asociaciones del sector y colaboramos con ellas con el objetivo de promover la cultura de la luz. A nuestro equipo de profesionales especializados en diseño industrial e I+D, también se suman las colaboraciones de diseñadores externos de prestigio en el sector de la iluminación.

En nuestros headquarters, de 12.000m2, disponemos de un centro logístico con capacidad para 10.000 palets de almacenamiento, además de nuestras oficinas centrales y nuestro showroom. También contamos con una zona de ensamblaje y mecanizados, e ingeniería especializada en diseño industrial e I+D. Adicionalmente, ofrecemos un servicio rápido de entrega, con más de 200 pedidos enviados al día; todos ellos habiendo superado exitosamente diversos controles técnicos y de calidad.

En Novolux Lighting, trabajamos y procedemos según el sistema de gestión de calidad que establece la norma ISO 9001:2015, aprobada por la empresa IQNet y AENOR.

## Light culture

In Novolux Lighting we are linked to several associations of the lighting industry, and we collaborate with them with the aim of promoting the culture of light. In addition to our team of professionals specialised in industrial design and R&D, we also have the help of renowned external designers in the lighting industry.

At our 12,000m2 headquarters, we boast a logistics center with a 10,000-pallet storage capacity, alongside our central offices and showroom. Our facility includes an assembly and machining area, complemented by specialized engineering in industrial design and R&D. Additionally, we provide swift delivery service, dispatching over 200 orders daily—each having successfully passed rigorous technical and quality controls.

At Novolux Lighting, we operate under the ISO 9001:2015 quality management system, accredited by IQNet and AENOR.\*

Colaboraciones  
Collaborations

**ambit**  
LIVING SPACES CLUSTER

**CICAT**

**Secartys**

**FEDAL**  
LIGHTING TEAM SPAIN

# Sostenibilidad y producción de proximidad

En Novolux Lighting apostamos cada vez más por la producción de proximidad, por lo que estamos comprometidos con la industria local y la producción cercana a nuestros centros productivos.

Además, nos preocupamos por el medio ambiente y cada año implantamos nuevas medidas para reducir nuestra huella de carbono en todos los procesos de producción.

# Sustainability and local production

In Novolux Lighting we are committed to local manufacturing, so we are engaged with local industry and production close to our manufacturing centres.

In addition, we care about the environment and every year we implement new measures to reduce our carbon footprint in all production processes.







# Ilumina tu imaginación

En Novolux Lighting disponemos de talleres de fabricación y montaje propios que nos permiten fabricar luminarias decorativas para proyectos y adaptarnos a cualquier necesidad de ensamblaje o de materiales que nos propongas. Damos luz a tus diseños haciendo realidad la luminaria que has soñado. Siempre con la supervisión y el soporte de nuestro departamento técnico y de diseño. Y fabricamos pantallas en medidas y acabados especiales a partir de 15 unidades (consultar plazos y precios).

# Light up your imagination

Novolux Lighting owns manufacturing and assembly workshops to manufacture decorative luminaires for projects, adapting to any assembly or material need. We give light to your designs, turning the luminaire you dreamed into a reality. Always under the supervision and support of our technical and design department. And We manufacture screens in special sizes and finishes from 15 units (check terms and prices).

# Pasión por la luz

Apasionados por la luz, entendemos la iluminación como un elemento vital para mejorar, no solo las características físicas de los espacios, sino también las actividades que ahí se desarrollan y el bienestar de las personas que habitan o hacen uso de los mismos. Nuestro equipo trabaja con el compromiso de ofrecer la mejor solución luminica a tu proyecto. Gracias a nuestro servicio de asesoría personalizada, estudiamos las necesidades específicas que requiere cada obra para brindarte una respuesta que cumpla con las exigencias de tu proyecto. Contacta con nuestro departamento de proyectos: [proyectos@novoluxlighting.com](mailto:proyectos@novoluxlighting.com)

# Passion for light

We are passionate for light and we understand lighting as a vital element to improve not only the physical characteristics of spaces but also the activities that are carried out there, as well as the well-being of the people that live or spend time in those spaces. Our team is committed to offering the best lighting solution for your project. Thanks to our customised consulting service, we study the specific needs of each task to provide a solution that meets the requirements of your project. Contact our Project Department: [proyectos@novoluxlighting.com](mailto:proyectos@novoluxlighting.com)

Biblioteca de la Universidad de Málaga — Library of the University of Malaga.

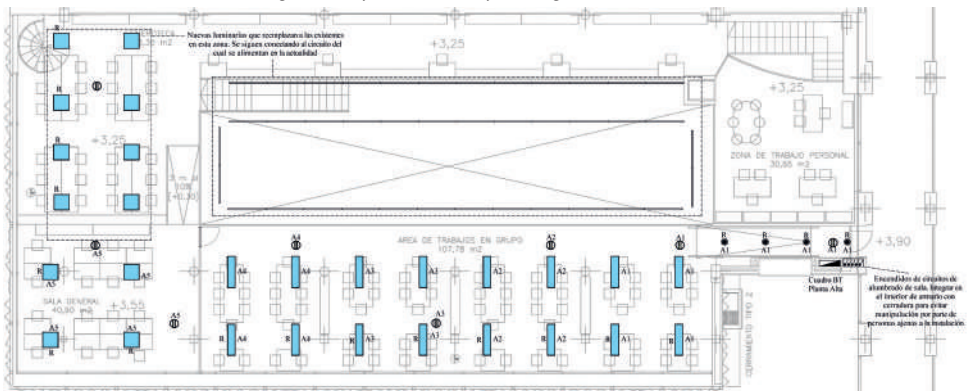



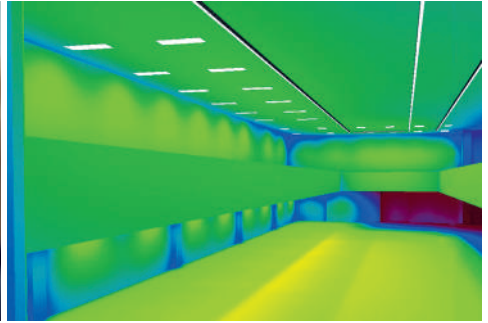
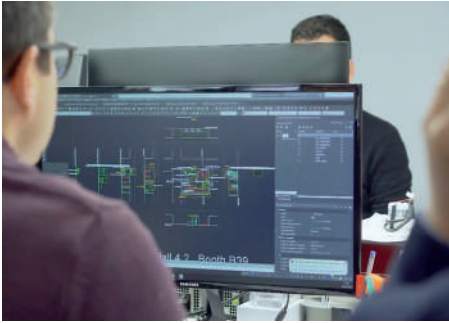

Biblioteca de la Universidad de Málaga — Library of the University of Malaga.





Panadería Domi Vélez de Lebrija, Sevilla — Domi Vélez Bakery in Lebrija, Seville.



# Ecommerce B2B

para nuestros clientes — For our clients



Seguimiento de tus pedidos  
Track your orders



Consulta de stock  
Check stock availability



Grandes descuentos  
Great discounts



Información de producto  
Product information



Atención por Live Chat  
Live chat customer support



Oficina Virtual  
Virtual office

¿Aun no te has registrado? ¡Contáctanos  
y nuestro equipo te ayudará online!  
Haven't you registered yet? Contact us  
and our team will help you online!

Despacho Señorita Templeton, Barcelona — Miss Templeton's Office, Barcelona.







# DOWNLIGHTS

indeluz

## Empotrables — Recessed



SCOP  
50



∅ 118-176

OUO  
52



∅ 95-145-195

VIP1  
54



∅ 60

VIP1T  
62



∅ 78

VIP2  
64



∅ 78

VIP2  
66



145 X 78

VIP2T  
68



∅ 78

VIP3  
70



∅ 78

VIP3  
72



145 X 78

VIP3T  
74



∅ 78

PALMA  
76



∅ 75 IP 65

CARPO  
78



∅ 74 IP 65

MINI LUNA  
80



∅ 95

NIX  
82



∅ 65 ∅ 75

INEL  
84



∅ 70 IP 65

LEDA  
86



∅ 76

KOS  
87



∅ 85

LEN  
88



∅ 124 ∅ 133

ATOLON  
90



∅ 152  
300 X 152  
450 X 152  
600 X 152  
∅ 300

MAB  
95



∅ 610

SPLAT  
97

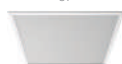

∅ 610

SINOPE  
100



212 X 131

## Superficie — Surface



BILOG  
93



MAB  
94



SPLAT  
96



VALGUS  
99



BUIS  
101



Suspensión — Pendant



LINEAR LIGHTS

Aplique pared — Wall-mounted



Empotrables — Recessed



Superficie — Surface



Suspensión — Pendant



SPOTLIGHTS

Proyectores — Spotlights

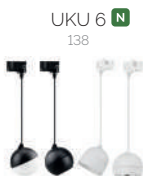

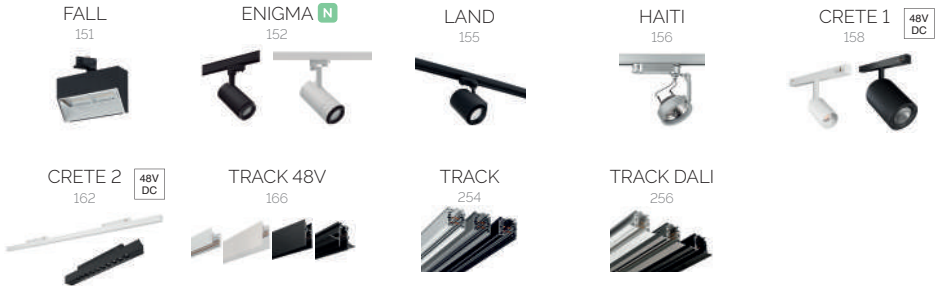

## LED STRIP



KRAO **N**  
214



NOK 1  
216



NOK 2  
216



NOK 3  
217



NOK 4  
217



ATOLON  
218

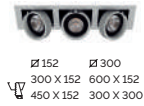

LEN  
220



PEGASO  
221



JANO  
221



PALMA  
222



MINI LUNA  
223



NIX  
224



CARPO  
226



INEL  
226



KOS  
227



KALE  
228



LEDA  
229



JANUS  
230



IBIZA  
231



CALYPSO 2  
232



HIMMEL  
233



GIA  
234



CARME **N**  
237



LAUTAN **N**  
239



CROUS  
240



COVER **N**  
243



WINDOW 2  
244



LIGUR  
245



OFFICE **N**  
247



TEN  
249



AMY  
251



HAITI  
252



TRACK  
254

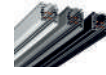

TRACK DALI  
256



# WALL LIGHTS

exo

Superficie — Surface



SIGN **N**  
265



TEC **N**  
267



EYE **N**  
266



KRISTA  
271



TOSCA  
273



TANIA  
274



OXY  
276



DIAGONAL  
277



CLASSICAL  
278



AMSTERDAM  
279



CORA  
280



NEMO  
281



COMPACT  
282



BRITTA  
283



FIRENZE  
285



A TU ESTILO  
287



VALAN  
287



MONTECARLO  
288



ARM  
289



TEAR  
290



BOOK **N**  
291



DIRK  
292



MINIMAL  
293



SKIN  
295



SERENE  
296



BALTIC  
298



TOSCANA  
299



ELFI  
300



OLVAS  
300



LEIDEN  
301



RETT **N**  
303



PETAL  
304



CIRCULAR **N**  
305



COOPER **N**  
307



IONA  
308



BRICK  
309



DENEK  
310



MENKAR  
311



ESPIGA  
311



PYRAMID  
311



CIRCUS  
311





# PENDANT & CEILING LAMPS

exo

## Suspensión — Pendant



TEC **N**  
315



FISH **N**  
317



TWIST  
321



KRISTA  
323



OXY **N**  
327



FLAKE **N**  
331



TOSCA  
333



TANIA  
336



DIAGONAL  
340



VALAN  
341



AKIRO  
343



NATURAL **N**  
345



THAIS **N**  
347



VIETNAM **N**  
349



MOLIN  
351



CORA  
352



FIRENZE  
353



VORADA  
354



FRED  
358



A TU ESTILO  
360



BAGUET  
363



ELGA  
364



A TU ESTILO  
365



TANNA  
367



EASY  
369



VINTAGE  
371



## Superficie — Surface



TANIA **N**  
335



VORADA  
354



FRED  
358



VINYL **N**  
357



# FLOOR & TABLE LAMPS

exo

Pie y sobremesa — Floor & Table lamps



GEOMETRICAL **N**  
375



TEC **N**  
377



TWIST **N**  
379



KRISTA  
381



CERAMIC  
383



TANIA  
385



AKIRO  
387



NEMO **N**  
389



DIAGONAL  
390



CLASSICAL  
392



AMSTERDAM  
394



CORA  
396



FIRENZE  
398



COMPACT  
400



BRITTA  
402



LARS  
405



WOOD  
407



KARA  
408



TAICHI **N**  
410



SINTRA  
412



ZANZIBAR  
413



MANTIS  
414



VALAN **N**  
415



BRANCH  
416



MONTECARLO  
417



# BATH

exo

## Superficie — Surface



ICY  
420



TILT  
421



DEW  
423



SLEET  
424



BLIZZARD  
427



SHEID  
428



LITS  
428



CARPI  
429



MINERVA  
431



AFRODITA  
433



## CEILING FANS

### Ventiladores con luz — Fans with light



MISTRAL **N**  
437



### Ventiladores sin luz — Fans without light



MISTRAL **N**  
437



FUJIL  
439



# WALL LIGHTS

Dopo

Superficie — Surface



ORBITA <sup>N</sup>  
444



MURA <sup>N</sup>  
445



EVEN <sup>N</sup>  
446



IKONA <sup>N</sup>  
448



CROMA <sup>N</sup>  
449



SIMIL  
450



LUG  
451



LOOP  
452



BUCKET  
453



AVON  
454



ADAY  
455



CASTELLO  
456



ARLEN  
457



BEAM  
458



RHIN  
459



FROST  
460



CLOUD  
460



CUB <sup>N</sup>  
462



SUEVIS  
466



CAIRO  
467



GUIU  
467



ARTAL  
468



CENADI  
468



CICLON  
469



NUMBER  
470



ABAR  
471



JEDY  
472



PAMPERO  
472



KIRA  
473



FLOC <sup>N</sup>  
475



ABREGO  
476



GALERNA  
476



CAYU  
477



ESTEL  
478



STORM  
479



CALM  
480



HAIL  
480



BELENLUX  
482



DELFI  
483



MIR  
483



PIRO  
484



TEIA  
485



FAR  
486



KAPPA  
488



PRIMA  
489



DEVON  
490



Empotrables — Recessed



DEVON  
492



∅ 96    √ 180X104 / 284X104

DAMBEL  
494



√ 65X171

LARA  
495



√ 98X160

AMBERES  
496



√ 240X74

DAS  
496



√ 65X240

XALOC  
497



√ 243X102

WIND  
498



√ 250X50

DONISI  
499



∅ 32

# DOWNLIGHTS

Dopo

Superficie — Surface



KIRA  
473



PAMPERO  
472



CAYU  
477



BELENLUX  
482



DELFI  
483



MIR  
483



PIRO  
484



TEIA  
485



FAR  
486



MIST  
500



CUB  
500



Empotrables — Recessed



DONISI  
499



☞ Ø 32

# UPLIGHTS

Empotrables — Recessed



SHINNY  
504



BERNA  
504



☞ Ø 62

SIO  
505



☞ Ø 114

BORA  
507



☞ Ø 92 / 106

ADGO  
508



☞ Ø 192

WALKER  
508



☞ Ø 166

PUELICHE  
509



☞ 630 X 73

MARTINA  
510



☞ Ø 118

BELGRADO  
511



☞ Ø 85-117-147

RAIN  
512



☞ Ø 47

# SPOTLIGHTS

Dopo

Proyectors — Spotlights



KERO **N**  
517



ABADIA  
518



NAGORE  
518



BARNI  
520



SENDAI  
521



TERRA  
522



GERONIMO  
523



LULU  
523



CATANIA  
524



ARAMO  
524



KOBE  
526



SEDNA  
527



RIGA  
529



RIGA RGB  
531



# BOLLARDS

Dopo

Balizas – Bollards



ORBITA **N**  
535



h 650

IKONA **N**  
537



h 400 / 750

SIMIL  
538



h 500

LUG  
539



h 350 / 650

BUCKET  
541



h 300 / 600

LOOP  
543



h 500 / 1000

AVON  
544



h 500

GUIU  
545



h 750

SUEVIS  
546



h 650

CAIRO  
547



h 650

CASTELLO  
548



h 495

ADAY  
549



h 900 / 2200

ARLEN  
550



h 230

ADRANO  
551



h 650

SIBILA  
552



h 800 / 650

ODIN  
553



h 250 / 500

LUA  
554



h 478

JASMIN  
554



h 650

OMO  
556



h 300 / 400 / 600 / 800

NATAN  
557



h 890

SIROCO  
557



h 650

SAURO  
558



h 500 / 800 / 1100

ABREGO  
559



h 450

GALERNA  
559



h 450





## Señalización solar – Solar signage

ERGO  
563



VERSA  
564



LUMBER  
565



TONA  
567



COMO  
568



SOLEI  
571



## DECORATIVE

### Decorativa – Decorative

LITTA  
575



BLOMMA  
576



ERICE  
577



BLED  
578



GLOU  
580



PORTOFINO  
581



Clásico residencial — Classic residential

OTTONE  
584



MEDI  
585



KEO  
585



VIC  
592



TROM  
586



BOOM  
588



CAST  
590



INDURA GLOBO  
592



GLOBI  
597



CLIC CLAC GLOBO  
598



GLOBOS Y SOPORTE  
(Ø45) — (Ø60) — (Ø75)  
600



POSTES  
(Ø60)  
602



ROUND  
605



QUADRA  
606



ROB  
608



POSTES  
(Ø45)  
611



CLIC CLAC 4

612



VILLA CHAP

614



CITY INDURA

615



INDURA MEDIUM 4

616



INDURA MINI 4

618



INDURA MINI 6

619



INDURA MEDIUM 6

620



INDURA BIG 6

622



CLIC CLAC 6

624



ELITE 6

626



POSTES

629



VILLA BIG

630



GUNTHER (Ø48)–(Ø60)

632



GUNTHER TOP

635



# WALL LIGHTS

**Cristher**

## Superficie — Surface



**DUOMO** <sup>N</sup>  
640



**DION**  
641



**STONE**  
642



**LANCE** <sup>N</sup>  
645



**GEOMETRIC**  
647



**HERA** <sup>N</sup>  
648



**ALDIOLA** <sup>N</sup>  
649



**ISORA** <sup>N</sup>  
651



**SETH**  
654



**SLIM**  
658



**RIMA**  
660



**VIENA** <sup>N</sup>  
662



**DAIRA**  
663



**PLAFF**  
664



**ALBA**  
665



## Empotrables — Recessed



**DAIN**  
646



∇ 150X150 ∇ 80X150

**SLIM**  
658



∇ 124X124 ∇ ∅ 143  
223

**RIMA**  
661



∇ ∅ 143

**COC**  
666



∇ 126 X 273

**DUBLIN**  
667



∇ 290 X 105

**ARGIN**  
668



∇ 242 X 67

**SYNA**  
669

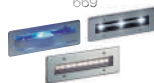

∇ 177 X 56

**NAT-LED**  
691



∇ ∅ 80

# DOWNLIGHTS

Cristher

## Superficie — Surface



STONE  
673



VIENA  
662



DAIRA  
663



PLAFF  
664



ALBA  
665



## Empotrables — Recessed



ATIC  
674



⌘ ∅ 90 / 130 / 165 / 210

NABUCO  
677



⌘ ∅ 32 / 50

# UPLIGHTS

## Empotrables — Recessed



NABUCO  
681



⌘ ∅ 75

ESTAMBUL  
683



⌘ ∅ 92

FOCUS  
683



⌘ ∅ 104

MALVA **N**  
684



⌘ ∅ 135 / 216 / 216 / 237

MALVA RGB  
687



⌘ ∅ 112

SOFIA  
689



⌘ ∅ 177 / 300

NAT-LED  
691



⌘ ∅ 80

GARDA **N**  
693



⌘ ∅ 80 / 135

NODY  
694



⌘ ∅ 46 / 56

SURI  
695



⌘ ∅ 110

SURI BIG  
695



⌘ ∅ 186

# WALL WASHERS

**Cristher**

Bañador de pared — Wall washers

LANCE  
699



WALK  
700



WALK RGB  
703



# SOLAR

Señalización solar — Solar signage



INTI  
706



MITRA  
707



UTU MINI  
707



UTU ROUND  
707



# SPOTLIGHTS

Proyectores — Spotlights



KALOS **N**  
711



STONE **N**  
713



BAMBOLA **N**  
714



HAMELIN  
715



DISC  
717



DADO **N**  
718



GIBSON  
721



LANCE  
723



TIR  
724



ABBI  
724



TINA  
725



LISBOA  
727



# BOLLARDS

Cristher

Balizas — Bollards



PALAU **N**  
730



h 500 / 800

DUOMO **N**  
733



h 300 / 600 / 900

STONE **N**  
735



h 535

DION **N**  
737



h 250 / 600 / 1000

DAIN  
739



h 300 / 700

TURRET  
740



h 500 / 750

AURA **N**  
742



h 260 / 400 / 680 / 2000

MAXIMA **N**  
744



h 593 / 1000 / 2000 / 2480 / 3000

BINDELLA **N**  
746



h 650

MINI NICO  
746



h 65 / 457

CLINA **N**  
748



h 558

ANTIBES  
749



h 135

NOVA  
750



h 500 / 650

COK  
751



320 / 420 / 620 / 820

FRAM  
752



h 705

MIRCO  
753



h 280 / 650

# URBAN LIGHTING

**Cristher**

Iluminación urbana — Urban lighting



FANAL **N**  
757



VENT **N**  
759



FENDER  
761



ARYA **N**  
762



VICO  
762



POSTES  
763



# DECORATIVE

Decorativa — Decorative

NELL **N**  
766



TASMANIA  
768



CYLINDER  
769



BALLON  
770



BLOCK  
771



# UNDERWATER LIGHTS

Sumergibles — Underwater lights



PAR 56  
774



KIT PAR 56  
775



CONTROL RGB  
776



BELT  
778



PRAGA  
778



CUP  
780



PAL  
782



NINO  
783



LYNN  
783



GAMBLE MAXI  
/ PLUS  
784



FOCUS  
786





# ACCESSORIES

---

LED T2  
790



LED FILAMENT  
791



LED PRO  
792



G9  
792



R7S  
792



CONNECTORES  
CONNECTORS  
793



FUENTES DE ALIMENTACIÓN  
POWER SUPPLIES  
794



# GENERAL INFORMATION

---

ACABADOS  
FINISHES

798

MATERIALES  
MATERIALS

800

RECOMENDACIONES DE USO E INSTALACIÓN  
PARA TIRAS LED  
RECOMMENDATIONS FOR USE AND INSTALLATION  
FOR LED STRIPS

803

RECOMENDACIONES DE USO E INSTALACIÓN  
RECOMMENDATIONS FOR USE AND INSTALLATION

805

PICTOGRAFÍA  
SYMBOLOLOGY

806

CONDICIONES GENERALES DE VENTA  
GENERAL CONDITIONS OF SALE

812

ÍNDICE DE REFERENCIAS  
INDEX OF REFERENCES

814

## FAMILY INDEX

### A

A TU ESTILO	EXO	287,360,365
ABADIA	DOPO	518
ABAR	DOPO	471
ABBI	CRISTHER	724
ABREGO	DOPO	476,559
ADAY	DOPO	455,549
ADGO	DOPO	508
ADRANO	DOPO	551
AFRODITA	EXO	432
AKIRO	EXO	342,386
ALBA	CRISTHER	665
ALDIOLA	CRISTHER	649
ALIMENTADORES	NX Lighting	211,794
AMBERES	DOPO	496
AMPLIFICADORES	INDELUZ	210
AMSTERDAM	EXO	279,394
AMY	INDELUZ	250
ANTIBES	CRISTHER	749
ARAMO	DOPO	524
ARGIN	CRISTHER	668,691
ARLEN	DOPO	457,550
ARM	EXO	289
ARROW	INDELUZ	142
ARTAL	DOPO	468
ARYA	CRISTHER	762
ATIC	CRISTHER	674
ATOLON	INDELUZ	90,218
AURA	CRISTHER	742
AVON	DOPO	454,544

### B

BAGUET	EXO	362
BALLON	CRISTHER	770
BALTIC	EXO	298
BAMBOLA	CRISTHER	714
BARNI	DOPO	520
BEAM	DOPO	458
BELENLUX	DOPO	482
BELGRADO	DOPO	511
BELT	CRISTHER	778
BERNA	DOPO	504
BILOG	INDELUZ	92
BINDELLA	CRISTHER	746
BLD	DOPO	578
BLIZZARD	EXO	426
BLOCK	CRISTHER	771
BLOMMA	DOPO	576
BOOK	EXO	291
BOOM	DOPO	588
BORA	DOPO	506
BRANCH	EXO	416
BRICK	EXO	309
BRITTA	EXO	283,402
BUCKET	DOPO	453,540
BUIS	INDELUZ	101

### C

CAIRO	DOPO	467,547
CALM	DOPO	480
CALYPSO2	INDELUZ	232
CARME	INDELUZ	237
CARPI	EXO	429
CARPO	INDELUZ	78,226
CAST	DOPO	590
CASTELLO	DOPO	456,548
CATANIA	DOPO	524
CAYU	DOPO	477
CENADI	DOPO	468
CERAMIC	EXO	382
CICLON	DOPO	469
CIRCULAR	EXO	305
CIRCUS	EXO	311
CITY INDURA	DOPO	615
CLASSICAL	EXO	278,392
CLIC-CLAC 4	DOPO	612
CLIC-CLAC 6	DOPO	624
CLIC-CLAC GLOBO	DOPO	598
CLINA	CRISTHER	748
CLOUD	DOPO	460
COC	CRISTHER	666
COK	CRISTHER	751
COMO	DOPO	568
COMPACT	EXO	282,400
CONECTORES	NX Lighting	793
CONTROLADORES	INDELUZ	202
COOPER	EXO	306
CORA	EXO	280,352,396
COVER	INDELUZ	242
CRETE1	INDELUZ	158
CROMA	DOPO	449
CROUS	INDELUZ	240
CUB	DOPO	462,500
CUP	CRISTHER	780
CYLINDER	CRISTHER	769

# FAMILY INDEX

## D

DADO	CRISTHER	718
DAIN	CRISTHER	646,738
DAIRA	CRISTHER	663
DAMBEL	DOPO	494
DAS	DOPO	496
DELFI	DOPO	483
DENEB	EXO	310
DEVON	DOPO	490
DEW	EXO	422
DIAGONAL	EXO	277,340,390
DION	CRISTHER	641,736
DIRK	EXO	292
DISC	CRISTHER	716
DONISI	DOPO	499
DUBE	INDELUZ	144
DUBLIN	CRISTHER	667
DUOMO	CRISTHER	640,732

## E

EASY	EXO	368
ELFI	EXO	300
ELGA	EXO	364
ELITE 6	DOPO	626
ENIGMA	INDELUZ	152
ERGO	DOPO	562
ERICE	DOPO	577
ESPIGA	EXO	311
ESTAMBUL	CRISTHER	682
ESTEL	DOPO	478
EVEN	DOPO	446
EYE	EXO	268

## F

FALL	INDELUZ	150
FANAL	CRISTHER	756
FAR	DOPO	486
FENDER	CRISTHER	760
FENIX	INDELUZ	104
FIRENZE	EXO	284,353,398
FISH	EXO	317
FLAKE	EXO	331
FLOC	DOPO	474
FOCUS	CRISTHER	683,786
FRAM	CRISTHER	752
FRED	EXO	358
FROST	DOPO	460
FUJIL	EXO	439

## G

G9	NX Lighting	792
GALERNA	DOPO	476,559
GAMBLE-MAXI	CRISTHER	784
GAMBLE-PLUS	CRISTHER	784
GARDA	CRISTHER	692
GEOMETRIC	CRISTHER	647
GEOMETRICAL	EXO	374
GERONIMO	DOPO	523
GIA	INDELUZ	234
GIBSON	CRISTHER	720
GLOBI	DOPO	597
GLOBOS	DOPO	600
GLOU	DOPO	580
GUIU	DOPO	467,545
GUNTHER 48	DOPO	632
GUNTHER 60	DOPO	634
GUNTHER TOP	DOPO	635

## H

HAIL	DOPO	480
HAITI	INDELUZ	156,252
HAMELIN	CRISTHER	715

HERA	CRISTHER	648
HIDRA	INDELUZ	148
HIMMEL	INDELUZ	233

## I

IBIZA	INDELUZ	231
ICY	EXO	420
IKONA	DOPO	448,536
INDURA BIG 6	DOPO	622
INDURA GLOBO	DOPO	592
INDURA MEDIUM 4	DOPO	616
INDURA MEDIUM 6	DOPO	620
INDURA MINI 4	DOPO	618
INDURA MINI 6	DOPO	619
INEL	INDELUZ	84,226
INTI	CRISTHER	706
IONA	EXO	308
ISORA	CRISTHER	650

## J

JANO	INDELUZ	221
JANUS	INDELUZ	230
JASMIN	DOPO	554
JEDY	DOPO	472

## K

KALE	INDELUZ	228
KALOS	CRISTHER	710
KAPPA	DOPO	488
KARA	EXO	408
KEO	DOPO	585
KERO	DOPO	516
KIRA	DOPO	473
KOBE	DOPO	526
KOS	INDELUZ	227
KRAO	INDELUZ	214
KRISTA	EXO	270,322,380

# FAMILY INDEX

## L

LANCE	CRISTHER	645,698,722
LAND	INDELUZ	154
LARA	DOPO	495
LARS	EXO	404
LAUTAN	INDELUZ	239
LED FILAMENT	NX Lighting	791
LED PRO	NX Lighting	792
LED T2	NX Lighting	790
LEDA	INDELUZ	86,229
LEIDEN	EXO	301
LEN	INDELUZ	88,220
LIGUR	INDELUZ	245
LISBOA	CRISTHER	726
LITS	EXO	428
LITTA	DOPO	574
LOOP	DOPO	452,542
LUA	DOPO	554
LUG	DOPO	451,539
LULU	DOPO	523
LUMBER	DOPO	565
LYNN	CRISTHER	783

## M

MAB	INDELUZ	94
MALVA	CRISTHER	684
MALVA RGB	CRISTHER	687
MANTIS	EXO	414
MARTINA	DOPO	510
MAXIMA	CRISTHER	744
MEDI	DOPO	585
MENKAR	EXO	311
MINERVA	EXO	430
MINI LUNA	INDELUZ	80,223
MINI NICO	CRISTHER	746
MINIMAL	EXO	293
MIR	DOPO	483

MIRCO	CRISTHER	753
MIST	DOPO	500
MISTRAL	EXO	436
MITRA	CRISTHER	707
MOLN	EXO	350
MONTECARLO	EXO	288,417
MURA	DOPO	445

## N

NABUCO	CRISTHER	676,680
NAGORE	DOPO	518
NATAN	DOPO	557
NAT-LED	CRISTHER	690
NATURAL	EXO	344
NELL	CRISTHER	766
NEMO	EXO	281,388
NILO 5	INDELUZ	182
NILO 8-10	INDELUZ	178
NILO BASIC	INDELUZ	176
NILO DUAL	INDELUZ	187
NILO EFFICIENCY	INDELUZ	188
NILO RGB	INDELUZ	184
NILO RGB+W	INDELUZ	186
NINO	CRISTHER	783
NIX	INDELUZ	82,224

NODY	CRISTHER	694
NOK	INDELUZ	216
NOVA	CRISTHER	750
NUMBER	DOPO	470

## O

ODIN	DOPO	553
OFFICE	INDELUZ	246
OLVAS	EXO	300
OMO	DOPO	556
ORBITA	DOPO	534

OTTONE	DOPO	584
OXY	EXO	276,326

## P

PAL	CRISTHER	782
PALAU	CRISTHER	730
PALMA	INDELUZ	76,222
PAMPERO	DOPO	472
PAR 56 LED	CRISTHER	774
PAR 56 ONLED	CRISTHER	775
PEGASO	INDELUZ	221
PERFILES TIRALED	INDELUZ	196
PETAL	EXO	304
PIRO	DOPO	484
PLAFF	CRISTHER	664
PORTOFINO	DOPO	581
POSTES	DOPO	602,611
PRAGA	CRISTHER	778
PRIMA	DOPO	489
PUELICHE	DOPO	509
PYRAMID	EXO	311

## Q

QUADRA	DOPO	606
QUO	INDELUZ	52

## R

R7s	NX Lighting	792
RAIN	DOPO	512
RETT	EXO	302
RHIN	DOPO	459
RIGA	DOPO	528
RIMA	CRISTHER	660
RINS	INDELUZ	190
ROB	DOPO	608
ROUND	DOPO	605

# FAMILY INDEX

## S

SAURO	DOPO	558
SCOP	INDELUZ	50
SEDNA	DOPO	527
SENA	INDELUZ	192
SENA RGB	INDELUZ	193
SENDAI	DOPO	521
SERENE	EXO	296
SETH	CRISTHER	654
SHEID	EXO	428
SHINNY	DOPO	504
SIBILA	DOPO	552
SIGMA	INDELUZ	118
SIGN	EXO	264
SIMIL	DOPO	450,538
SINOPE	INDELUZ	100
SINTRA	EXO	412
SIO	DOPO	505
SIROCO	DOPO	557
SKIN	EXO	294
SLEET	EXO	424
SLIM	CRISTHER	688
SOFIA	CRISTHER	691
SOLEI	DOPO	570
SPLAT	INDELUZ	96
STONE	CRISTHER	642,672, 712,734
STORM	DOPO	479
SUEVIS	DOPO	466,546
SURI	CRISTHER	695
SURI BIG	CRISTHER	695
SYNA	CRISTHER	668

## T

TAICHI	EXO	410
TANIA	EXO	274,334,384
TANNA	EXO	366
TASMANIA	CRISTHER	768
TEAR	EXO	290
TEC	EXO	266,314,376
TEIA	DOPO	485
TEN	INDELUZ	248
TERRA	DOPO	522
THAIS	EXO	346
TILT	EXO	421
TINA	CRISTHER	725
TIR	CRISTHER	724
TONA	DOPO	566
TOSCA	EXO	272,332
TOSCANA	EXO	299
TRACK	INDELUZ	254
TRACK 48V	INDELUZ	166
TROM	DOPO	586
TURRET	CRISTHER	740
TURT	INDELUZ	140
TWIST	EXO	320,378
U		
UKU	INDELUZ	126
UTU MINI	CRISTHER	707
UTU ROUND	CRISTHER	707

## V

VALAN	EXO	287,341,415
VALGUS	INDELUZ	98
VENT	CRISTHER	758
VERSA	DOPO	564
VIC	DOPO	596
VICO	CRISTHER	762
VIENA	CRISTHER	662
VIETNAM	EXO	348
VILLA BIG	DOPO	630
VILLA CHAP	DOPO	614
VINTAGE	EXO	370
VINYL	EXO	356
VIP	INDELUZ	58
VOLGA	INDELUZ	194
VORADA	EXO	354

## W

WALK	CRISTHER	700
WALKER	DOPO	508
WIND	DOPO	498
WINDOW 2	INDELUZ	244
WOOD	EXO	406

## X

XALOC	DOPO	497
-------	------	-----

## Z

ZANZIBAR	EXO	413
----------	-----	-----

# TECHNIC INDOOR







# Downlights



1004A-

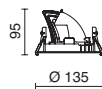



7,2W

13,2W

2700K	875lm	2700K	1448lm
3000K	889lm	3000K	1506lm
4000K	952lm	4000K	1613lm

Filtros / Filters



 Antideslumbrante / Anti-glare  
 ■ A04P-1002-02

 Prismático / Prismatic  
 ■ A47F-1002-92



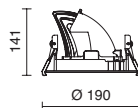

1004B-



17W

18,6W

29,7W

2000K <i>MEAT</i>	1741lm	2700K	2143lm	2700K	3325lm
2500K <i>BREAD</i>	2340lm	3000K	2221lm	3000K	3446lm
4000K <i>FISH</i>	2521lm	4000K	2436lm	4000K	3780lm
3000K <i>VEG+FRUIT</i>	2141lm	3250K <i>FASHION</i>	2180lm	3250K <i>FASHION</i>	3382lm

UGR <19

Filtros / Filters

 Antideslumbrante / Anti-glare  
 ■ A04P-1004-02

 Prismático / Prismatic  
 ■ A47H-1004-92



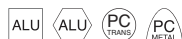
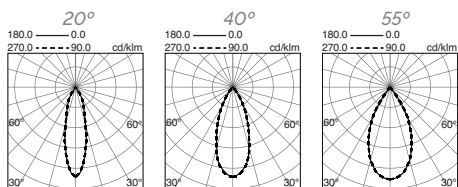

Acabado blanco con embellecedor blanco o cromado  
 White finish with white or chrome baffle

Con Driver remoto  
 With Remote Driver

Campos / Fields

Acabados/Finishes

<b>1</b>	<b>2</b>	<b>3</b>	<b>4</b>	<b>5</b>	<b>6</b>	<b>7</b>	<b>8</b>	<b>9</b>	<b>10</b>
----------	----------	----------	----------	----------	----------	----------	----------	----------	-----------

Familia Family	Modelo Model	Fuente de luz Lighting source	CRI / °K	Potencia (W) Power (W)	Voltaje Voltage	Óptica Light beam	Regulación Dimmable	Aro Ring	Embellecedor Baffle
-------------------	-----------------	----------------------------------	----------	---------------------------	--------------------	----------------------	------------------------	-------------	------------------------

<b>1</b>	<b>4</b>	<b>5</b>	<b>7</b>	<b>9</b>
1004 SCOP	38 CRI90 2700K 39 CRI90 3000K 40 CRI90 4000K 44 CRI82 2000K (MEAT) 46 CRI88 2500K (BREAD) 47 CRI92 4000K (FISH) 48 CRI96 3000K (VEG+FRUIT) 51 CRI95 3250K (FASHION)	08 7,2W 14 13,2W 17 18,6W 21 17W 33 29,7W	2 20° 4 40° 5 55°	01 <input type="checkbox"/>
<b>2</b>		<b>6</b>	<b>8</b>	<b>10</b>
A Small B Large		A AC110-240V B AC220-240V	0 ON-OFF F L.C (Trailing and leading edge) 1 PUSH/1-10V D DALI M CASAMBI	01 <input type="checkbox"/> 32 <input checked="" type="checkbox"/>
<b>3</b>				
L LED COB				

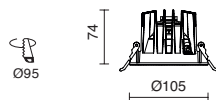

<b>1</b>	<b>2</b>	<b>3</b>	<b>4</b>	<b>5</b>	<b>6</b>	<b>7</b>	<b>8</b>	<b>9</b>	<b>10</b>
1004	A	L	38 39 40	08	A		0	01	01 32
					B	2	F		
					B	4	D		
					A	5	1		
					B		M		
					A		0		
				14	B	2	F		
					A	4	D		
					A	5	1		
					B		M		
					A		0		
					B	2	F		
	21		A	4	D				
			A	5	1				
			B		M				
			A		0				
			B	2	F				
			A	4	D				
	33		A	5	1				
			B		M				
			A		0				
			B	2	F				
			A	4	D				
			A	5	1				
17	B		M						
	A		0						
	B	2	F						
	A	4	D						
	A	5	1						
	B		M						
51	A		0						
	B	2	F						
	A	4	D						
	A	5	1						
	B		M						
	A		0						
33	A	2	F						
	A	4	D						
	A	5	1						
	B		M						
	A		0						
	B	2	F						



7,2W		13,2W	
2700K	875lm	2700K	1448lm
3000K	889lm	3000K	1506lm
4000K	952lm	4000K	1613lm

**Filtros / Filters**

**Antideslumbrante / Anti-glare**  
 ■ AO4P-1004-02

**Prismatic / Prismatic**  
 ■ A47H-1004-92 

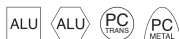

Acabado blanco con embellecedor blanco o cromado  
 White finish with white or chrome baffle

Con Driver remoto  
 With Remote Driver

1005B- (Large)    1005C- (Jumbo)

p.54	p.56
	

Campos / Fields

Acabados/Finishes

<b>1</b>	<b>2</b>	<b>3</b>	<b>4</b>	<b>5</b>	<b>6</b>	<b>7</b>	<b>8</b>	<b>9</b>	<b>10</b>
----------	----------	----------	----------	----------	----------	----------	----------	----------	-----------

Familia Family	Modelo Model	Fuente de luz Lighting source	CRI / °K	Potencia (W) Power (W)	Voltaje Voltage	Óptica Light beam	Regulación Dimmable	Aro Ring	Embellecedor Baffle
-------------------	-----------------	----------------------------------	----------	---------------------------	--------------------	----------------------	------------------------	-------------	------------------------

<b>1</b>	<b>4</b>	<b>5</b>	<b>7</b>	<b>9</b>
1005 <i>QUO</i>	38 <i>CR190 2700K</i> 39 <i>CR190 3000K</i> 40 <i>CR190 4000K</i>	08 <i>7,2W</i> 14 <i>13,2W</i>	2 <i>20°</i> 4 <i>40°</i> 5 <i>55°</i>	01 <input type="checkbox"/>
<b>2</b>		<b>6</b>	<b>8</b>	<b>10</b>
A <i>Small</i>		A <i>AC110-240V</i> B <i>AC220-240V</i>	0 <i>ON-OFF</i> F <i>LC</i> <i>(Trailing and leading edge)</i> 1 <i>PUSH/1-10V</i> D <i>DALI</i> M <i>CASAMBI</i>	01 <input type="checkbox"/> 32 <input checked="" type="checkbox"/>
<b>3</b>				
L <i>LED COB</i>				

<b>1</b>	<b>2</b>	<b>3</b>	<b>4</b>	<b>5</b>	<b>6</b>	<b>7</b>	<b>8</b>	<b>9</b>	<b>10</b>
1005	A	L	38 39 40	08  14	A B B A B  A B A A B	2 4 5  2 4 5	O F D 1 M  O F D 1 M	01	32

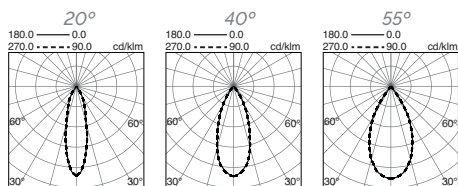

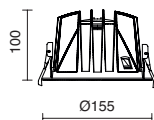

17W		18.6W		29.7W	
2000K MEAT	1741lm	2700K	2143lm	2700K	3325lm
2500K BREAD	2340lm	3000K	2221lm	3000K	3446lm
4000K FISH	2521lm	4000K	2436lm	4000K	3780lm
3000K VEG+FRUIT	2141lm	3250K FASHION	2180lm	3250K FASHION	3382lm

Filtros / Filters

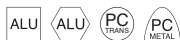
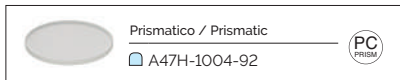
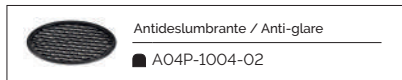

Acabado blanco con embellecedor blanco o cromado  
White finish with white or chrome baffle

Con Driver remoto  
With Remote Driver

1005A- (Small) 1005C- (Jumbo)



Campos / Fields

Acabados/Finishes

<b>1</b>	<b>2</b>	<b>3</b>	<b>4</b>	<b>5</b>	<b>6</b>	<b>7</b>	<b>8</b>	<b>9</b>	<b>10</b>
----------	----------	----------	----------	----------	----------	----------	----------	----------	-----------

Familia Family	Modelo Model	Fuente de luz Lighting source	CRI / %K	Potencia (W) Power (W)	Voltaje Voltage	Óptica Light beam	Regulación Dimmable	Aro Ring	Embelecedor Baffle
-------------------	-----------------	----------------------------------	----------	---------------------------	--------------------	----------------------	------------------------	-------------	-----------------------

<b>1</b>	<b>4</b>	<b>5</b>	<b>7</b>	<b>9</b>
1005 QUO	38 CRI90 2700K 39 CRI90 3000K 40 CRI90 4000K	17 17W 21 18,6W 33 29,7W	2 20° 4 40° 5 55°	01 <input type="checkbox"/>
<b>2</b>	44 CRI82 2000K (MEAT) 46 CRI88 2500K (BREAD) 47 CRI92 4000K (FISH) 48 CRI96 3000K (VEG+FRUIT) 51 CRI95 3250K (FASHION)			
B Large		<b>6</b>	<b>8</b>	<b>10</b>
<b>3</b>		A AC110-240V B AC220-240V	O ON-OFF F L,C (Trailing and leading edge) 1 PUSH/1-10V D DALI M CASAMBI	01 <input type="checkbox"/> 32 <input checked="" type="checkbox"/>
L LED COB				

1	2	3	4	5	6	7	8	9	10	
1005	B	L	44	17	A			O	01	01 32
			46		B	2	F			
			47		A	4	D			
			48		A	5	1			
					B		M			
			38	21	A		O			
			39		B	2	F			
			40		A	4	D			
					A	5	1			
					B		M			
			51	33	A		O			
					B	2	F			
					A	4	D			
					A	5	1			
					B		M			
						38	33	A		
			39	A	2	D				
			40	A	4	D				
				A	5	1				
				B		M				
			51		A	2	O			
					A	4	D			
					A	5	1			
					B		M			

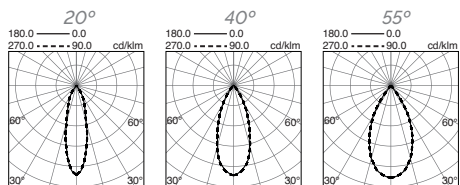

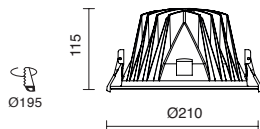



33,8W

2700K	3694lm
3000K	3993lm
4000K	4200lm
3250K <i>FASHION</i>	3758lm

**Filtros / Filters**

 Antideslumbrante / Anti-glare  
 ■ AO4P-1004-02

 Prismatico / Prismatic  
 ■ A47H-1004-92





Acabado blanco con embellecedor blanco o cromado  
 White finish with white or chrome baffle

Con Driver remoto  
 With Remote Driver

1005A- (Small)      1005B- (Large)





Campos / Fields

Acabados/Finishes

<b>1</b>	<b>2</b>	<b>3</b>	<b>4</b>	<b>5</b>	<b>6</b>	<b>7</b>	<b>8</b>	<b>9</b>	<b>10</b>
----------	----------	----------	----------	----------	----------	----------	----------	----------	-----------

Familia Family	Modelo Model	Fuente de luz Lighting source	CRI / %K	Potencia (W) Power (W)	Voltaje Voltage	Óptica Light beam	Regulación Dimmable	Aro Ring	Embellecedor Baffle
-------------------	-----------------	----------------------------------	----------	---------------------------	--------------------	----------------------	------------------------	-------------	------------------------

<b>1</b>	<b>4</b>	<b>5</b>	<b>7</b>	<b>9</b>
1005 QUO	38 CRI90 2700K 39 CRI90 3000K 40 CRI90 4000K 51 CRI95 3250K (FASHION)	36 33,8W	2 20° 4 40° 5 55°	01 <input type="checkbox"/>
<b>2</b>		<b>6</b>	<b>8</b>	<b>10</b>
C Jumbo		A AC110-240V B AC220-240V	0 ON-OFF F LC (Trailing and leading edge) 1 PUSH/1-10V D DALI M CASAMBI	01 <input type="checkbox"/> 32 <input type="checkbox"/>
<b>3</b>				
L LED COB				

<b>1</b>	<b>2</b>	<b>3</b>	<b>4</b>	<b>5</b>	<b>6</b>	<b>7</b>	<b>8</b>	<b>9</b>	<b>10</b>
1005	C	L	38 39 40	36	A A A B	2 4 5	O D 1 M	01	01 32
			51		A A A B	2 4 5	O D 1 M		

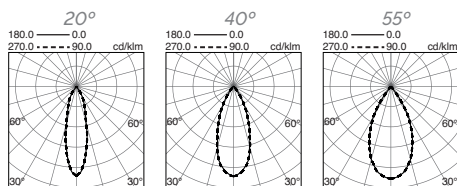

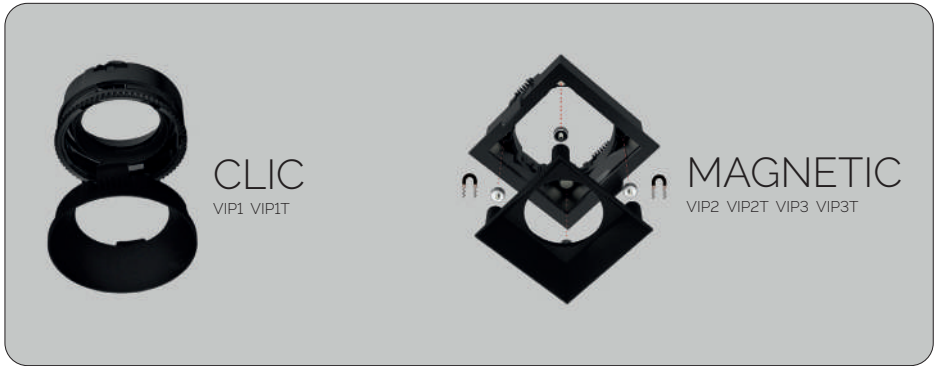

CLIC  
VIP1 VIP1T

MAGNETIC  
VIP2 VIP2T VIP3 VIP3T

- CRI 90
- CRI >97
- CRI >95 DTW
- TUNNABLE WHITE

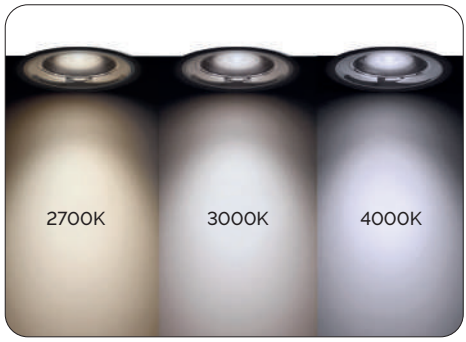

- ON-OFF
- L.C PHASE CUT
- PUSH 1-10V
- DALI
- CASAMBI

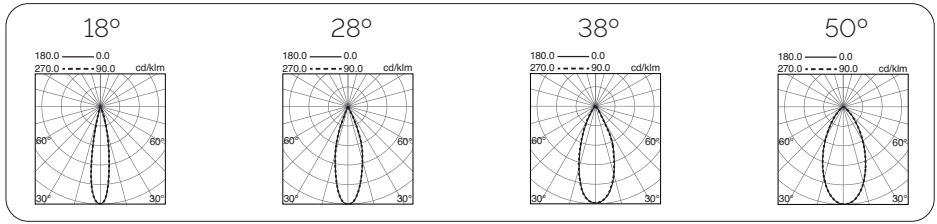
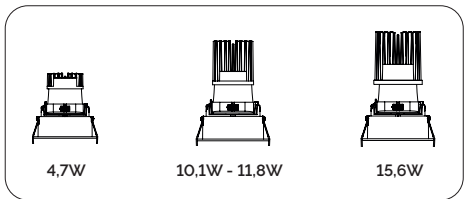



RECESSED

VIP 1

p.60



VIP 2

p.64



VIP 3

p.70

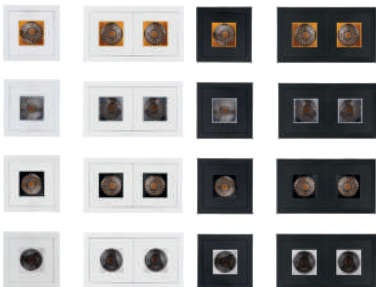

TRIMLESS

VIP 1T

p.62



VIP 2T

p.68



VIP 3T

p.74



Filtros / Filters



Antideslumbrante  
Anti-glare

■ A40Q-1006-02



Oval



A47Q-1006-92



(VIP1, VIP1T)



A47R-1006-92



(VIP2, VIP2T)



A47T-1006-92



Ø75

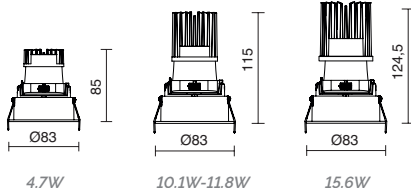

4,7W

10,1W-11,8W

15,6W

1006A-

CRI >90		
4,7W	10,6W	15,6W
2700K 650lm	2700K 1317lm	2700K 1940lm
3000K 680lm	3000K 1376lm	3000K 2028lm
4000K 719lm	4000K 1456lm	4000K 2145lm

CRI >97
10,1W
2700K 923lm
3000K 949lm
4000K 1031lm

CRI >95 DTW
11,8W
2000K 28lm
3000K 1179lm

TUNNABLE WHITE
10,6W
2700K 1278lm
6500K 1563lm

 FILTERS p.59



Acabado blanco o negro con embellecedor blanco, negro, cromado u oro / White or black finish with white, black, chrome or gold baffle



-01-01

-01-02

-01-32

-01-47

-02-01

-02-02

-02-32

-02-47

- 9 - 10

Con Driver remoto  
With Remote Driver

Campos / Fields

Acabados/Finishes

<b>1</b>	<b>2</b>	<b>3</b>	<b>4</b>	<b>5</b>	<b>6</b>	<b>7</b>	<b>8</b>	<b>9</b>	<b>10</b>
----------	----------	----------	----------	----------	----------	----------	----------	----------	-----------

Familia Family	Modelo Model	Fuente de luz Lighting source	CRI / °K	Potencia (W) Power (W)	Voltaje Voltage	Óptica Light beam	Regulación Dimmable	Aro Ring	Embellecedor Baffle
-------------------	-----------------	----------------------------------	----------	---------------------------	--------------------	----------------------	------------------------	-------------	------------------------

<p><b>1</b></p> <p>1006 VIP 1</p> <hr/> <p><b>2</b></p> <p>A Round Convex</p> <hr/> <p><b>3</b></p> <p>L LED COB</p>	<p><b>4</b></p> <p>38 CRI90 2700K 39 CRI90 3000K 40 CRI90 4000K 53 CRI97 2700K 54 CRI97 3000K 55 CRI97 4000K 56 TUNABLE WHITE 2700-6500K 57 CRI95 DIM TO WARM 2000K-3000K</p>	<p><b>5</b></p> <p>06 4,7W 13 10,1W- 11,8W 18 15,6W</p> <hr/> <p><b>6</b></p> <p>A AC110-240V B AC220-240V</p>	<p><b>7</b></p> <p>1 18° 2 28° 3 38° 5 50°</p> <hr/> <p><b>8</b></p> <p>O ON-OFF L C (Trailing and leading edge) 1 PUSH/1-10V D DALI M CASAMBI</p>	<p><b>9</b></p> <p>01 □ 02 ■</p> <hr/> <p><b>10</b></p> <p>01 □ 02 ■ 32 □ 47 ■</p>
--	---	--	--	--

1006	A	L	38 39 40	06	A			O	01 02	01 02 32 47
					B	1		O		
					B	2		F		
					A	3		1		
					A	5		D		
				B			M			
				13	B			O		
					B	1		F		
					A	2		1		
					A	3		D		
			A		5		D			
			18	B			O			
				B	1		F			
				B	2		1			
				B	3		D			
				B	5		D			
			53 54 55	13	B			O		
					B	1		F		
					A	2		1		
					A	3		D		
A	5				D					
56	13	B			D					
57	13	A	1		1					
		B	2		D					
		B	3		D					
		B	5		M					

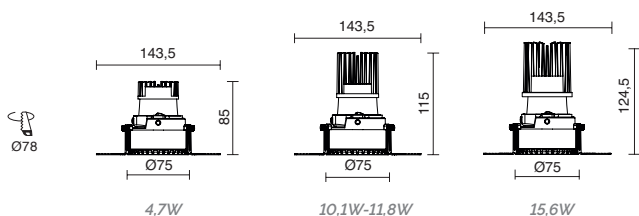

1009A-

CRI >90		
4,7W	10,6W	15,6W
2700K 650lm	2700K 1317lm	2700K 1940lm
3000K 680lm	3000K 1376lm	3000K 2028lm
4000K 719lm	4000K 1456lm	4000K 2145lm

CRI >97
10,1W
2700K 923lm
3000K 949lm
4000K 1031lm

CRI >95 DTW
11,8W
2000K 28lm
3000K 1179lm

TUNNABLE WHITE
10,6W
2700K 1278lm
6500K 1563lm

FILTERS p.59



Acabado blanco con embellecedor blanco, negro, cromado u oro / White finish with white, black, chrome or gold baffle



9 10

Con Driver remoto  
With Remote Driver

Campos / Fields

Acabados/Finishes

<b>1</b>	<b>2</b>	<b>3</b>	<b>4</b>	<b>5</b>	<b>6</b>	<b>7</b>	<b>8</b>	<b>9</b>	<b>10</b>
----------	----------	----------	----------	----------	----------	----------	----------	----------	-----------

Familia Family	Modelo Model	Fuente de luz Lighting source	CRI / °K	Potencia (W) Power (W)	Voltaje Voltage	Óptica Light beam	Regulación Dimmable	Aro Ring	Embellecedor Baffle
-------------------	-----------------	----------------------------------	----------	---------------------------	--------------------	----------------------	------------------------	-------------	------------------------

<b>1</b>	<b>4</b>	<b>5</b>	<b>7</b>	<b>9</b>
1009 VIP IT	38 CRI90 2700K 39 CRI90 3000K 40 CRI90 4000K 53 CRI97 2700K 54 CRI97 3000K 55 CRI97 4000K	06 4,7W 13 10,1W- 11,8W 18 15,6W	1 18° 2 28° 3 38° 5 50°	01 □
<b>2</b>		<b>6</b>		<b>10</b>
A Round Convex	56 TUNABLE WHITE 2700-6500K 57 CRI95 DIM TO WARM 2000K-3000K	A AC110-240V B AC220-240V		01 □ 02 ■ 32 ■ 47 ■
<b>3</b>			<b>8</b>	
L LED COB			0 ON-OFF F L.C (Trailing and leading edge) 1 PUSH/1-10V D DALI M CASAMBI	

<b>1</b>	<b>2</b>	<b>3</b>	<b>4</b>	<b>5</b>	<b>6</b>	<b>7</b>	<b>8</b>	<b>9</b>	<b>10</b>
1009	A	L	38 39 40	06	A B B A A	1 2 3 5	0 0 F 1 D	01	01 02 32 47
			53 54 55	13	B B A A B	1 2 3 5	0 F 1 D M		
			56	13	B		D		
			57	13	A B B	1 2 3 5	1 D M		



78x78

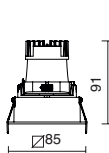

4,7W

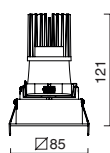

10,1W-11,8W

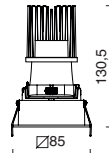

15,6W

1007A-

CRI >90		
4,7W	10,6W	15,6W
2700K 650lm	2700K 1317lm	2700K 1940lm
3000K 680lm	3000K 1376lm	3000K 2028lm
4000K 719lm	4000K 1456lm	4000K 2145lm

CRI >97
10,1W
2700K 923lm
3000K 949lm
4000K 1031lm

CRI >95 DTW
11,8W
2000K 28lm
3000K 1179lm

TUNNABLE WHITE
10,6W
2700K 1278lm
6500K 1563lm

 FILTERS p.59

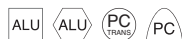

Acabado blanco o negro con embellecedor blanco, negro, cromado u oro / White or black finish with white, black, chrome or gold baffle



-01-01



-01-02



-01-32



-01-47



-02-01



-02-02



-02-32



-02-47

- 9 - 10

Con Driver remoto  
With Remote Driver



Campos / Fields

Acabados/Finishes

<b>1</b>	<b>2</b>	<b>3</b>	<b>4</b>	<b>5</b>	<b>6</b>	<b>7</b>	<b>8</b>	<b>9</b>	<b>10</b>
----------	----------	----------	----------	----------	----------	----------	----------	----------	-----------

Familia Family	Modelo Model	Fuente de luz Lighting source	CRI / °K	Potencia (W) Power (W)	Voltaje Voltage	Óptica Light beam	Regulación Dimmable	Aro Ring	Embellecedor Baffle
-------------------	-----------------	----------------------------------	----------	---------------------------	--------------------	----------------------	------------------------	-------------	------------------------

<b>1</b>	<b>4</b>	<b>5</b>	<b>7</b>	<b>9</b>
1007 VIP 2	38 CRI90 2700K 39 CRI90 3000K 40 CRI90 4000K 53 CRI97 2700K 54 CRI97 3000K 55 CRI97 4000K 56 TUNABLE WHITE 2700-6500K 57 CRI95 DIM TO WARM 2000K-3000K	06 4,7W 13 10,1W- 11,8W 18 15,6W	1 18° 2 28° 3 38° 5 50°	01 □ 02 ■
<b>2</b>		<b>6</b>	<b>8</b>	<b>10</b>
A Square Round		A AC110-240V B AC220-240V	0 ON-OFF F L.C (Trailing and leading edge) 1 PUSH/1-10V D DALI M CASAMBI	01 □ 02 ■ 32 □ 47 ■
<b>3</b>				
L LED COB				

<b>1</b>	<b>2</b>	<b>3</b>	<b>4</b>	<b>5</b>	<b>6</b>	<b>7</b>	<b>8</b>	<b>9</b>	<b>10</b>
1007	A	L	38 39 40  53 54 55  56  57	06  13  18  13	A B B A A  B B A A B  B B A A B	1 2 3 5  1 2 3 5  1 2 3 5	0 0 F 1 D  0 F 1 D M  0 F 1 D M	01 02	01 02 32 47

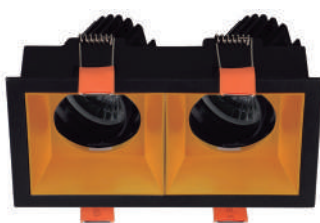

145x78

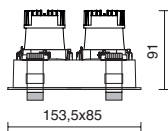

2x 4,7W

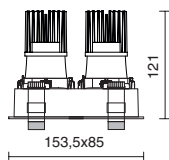

2x 10,1W-11,8W

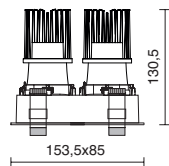

2x 15,6W

1007B-

CRI >90		
2x 4,7W	2x 10,6W	2x 15,6W
2700K 2x 650lm	2700K 2x 1317lm	2700K 2x 1940lm
3000K 2x 680lm	3000K 2x 1376lm	3000K 2x 2028lm
4000K 2x 719lm	4000K 2x 1456lm	4000K 2x 2145lm

CRI >97
2x 10,1W
2700K 2x 923lm
3000K 2x 949lm
4000K 2x 1031lm

CRI >95 DTW
2x 11,8W
2000K 2x 28lm
3000K 2x 1179lm

TUNNABLE WHITE
2x 10,6W
2700K 2x 1278lm
6500K 2x 1563lm

FILTERS p.59

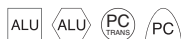

Acabado blanco o negro con embellecedor blanco, negro, cromado u oro / White or black finish with white, black, chrome or gold baffle



Con Driver remoto  
With Remote Driver

Campos / Fields

Acabados/Finishes

<b>1</b>	<b>2</b>	<b>3</b>	<b>4</b>	<b>5</b>	<b>6</b>	<b>7</b>	<b>8</b>	<b>9</b>	<b>10</b>
----------	----------	----------	----------	----------	----------	----------	----------	----------	-----------

Familia Family	Modelo Model	Fuente de luz Lighting source	CRI / °K	Potencia (W) Power (W)	Voltaje Voltage	Óptica Light beam	Regulación Dimmable	Aro Ring	Embellecedor Baffle
-------------------	-----------------	----------------------------------	----------	---------------------------	--------------------	----------------------	------------------------	-------------	------------------------

<b>1</b>	<b>4</b>	<b>5</b>	<b>7</b>	<b>9</b>
1007 VIP 2	38 CRI90 2700K 39 CRI90 3000K 40 CRI90 4000K 53 CRI97 2700K 54 CRI97 3000K 55 CRI97 4000K	06 2x 4,7W 13 2x 10,1W- 11,8W 18 2x 15,6W	1 18° 2 28° 3 38° 5 50°	01 □ 02 ■
<b>2</b>		<b>6</b>	<b>8</b>	<b>10</b>
B 2x Square Round	56 TUNABLE WHITE 2700-6500K 57 CRI95 DIM TO WARM 2000K-3000K	A AC110-240V B AC220-240V	0 ON-OFF F L.C (Trailing and leading edge) 1 PUSH/1-10V D DALI M CASAMBI	01 □ 02 ■ 32 □ 47 ■
<b>3</b>				
L LED COB				

<b>1</b>	<b>2</b>	<b>3</b>	<b>4</b>	<b>5</b>	<b>6</b>	<b>7</b>	<b>8</b>	<b>9</b>	<b>10</b>
1007	B	L	38 39 40	06	A B B A A	1 2 3 5	0 0 F 1 D	01 02	01 02 32 47
			53 54 55	13	B B A A B	1 2 3 5	0 F 1 D M		
			56	13	B		D		
			57	13	A B B	1 2 3 5	1 D M		

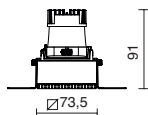

4,7W

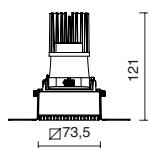

10,1W-11,8W

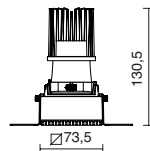

15,6W

## 1010A-

CRI >90		
4,7W	10,6W	15,6W
2700K 650lm	2700K 1317lm	2700K 1940lm
3000K 680lm	3000K 1376lm	3000K 2028lm
4000K 719lm	4000K 1456lm	4000K 2145lm

CRI >97
10,1W
2700K 923lm
3000K 949lm
4000K 1031lm

CRI >95 DTW
11,8W
2000K 28lm
3000K 1179lm

TUNNABLE WHITE
10,6W
2700K 1278lm
6500K 1563lm

 FILTERS p.59



Acabado blanco con embellecedor blanco, negro, cromado u oro / White finish with white, black, chrome or gold baffle



Con Driver remoto  
With Remote Driver

Campos / Fields

Acabados/Finishes

<b>1</b>	<b>2</b>	<b>3</b>	<b>4</b>	<b>5</b>	<b>6</b>	<b>7</b>	<b>8</b>	<b>9</b>	<b>10</b>
----------	----------	----------	----------	----------	----------	----------	----------	----------	-----------

Familia Family	Modelo Model	Fuente de luz Lighting source	CRI / °K	Potencia (W) Power (W)	Voltaje Voltage	Óptica Light beam	Regulación Dimmable	Aro Ring	Embellecedor Baffle
-------------------	-----------------	----------------------------------	----------	---------------------------	--------------------	----------------------	------------------------	-------------	------------------------

<b>1</b>	<b>4</b>	<b>5</b>	<b>7</b>	<b>9</b>
1010	VIP 2T	38 CRI90 2700K 39 CRI90 3000K 40 CRI90 4000K	06 4,7W 13 10,1W- 11,8W 18 15,6W	01 <input type="checkbox"/>
<b>2</b>		53 CRI97 2700K 54 CRI97 3000K 55 CRI97 4000K	<b>6</b>	<b>10</b>
A	Square Round	56 TUNABLE WHITE 2700-6500K 57 CRI95 DIM TO WARM 2000K-3000K	A AC110-240V B AC220-240V	01 <input type="checkbox"/> 02 <input type="checkbox"/> 32 <input type="checkbox"/> 47 <input type="checkbox"/>
<b>3</b>			<b>8</b>	
L	LED COB		0 ON-OFF F L.C (Trailing and leading edge) 1 PUSH/1-10V D DALI M CASAMBI	

<b>1</b>	<b>2</b>	<b>3</b>	<b>4</b>	<b>5</b>	<b>6</b>	<b>7</b>	<b>8</b>	<b>9</b>	<b>10</b>
1010	A	L	38 39 40	06	A B B A A	1 2 3 5	0 0 F 1 D	01	01 02 32 47
			53 54 55	13	B B A A B	1 2 3 5	0 F 1 D M		
			56	13	B		D		
			57	13	A B B	1 2 3 5	1 D M		

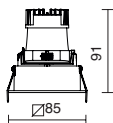
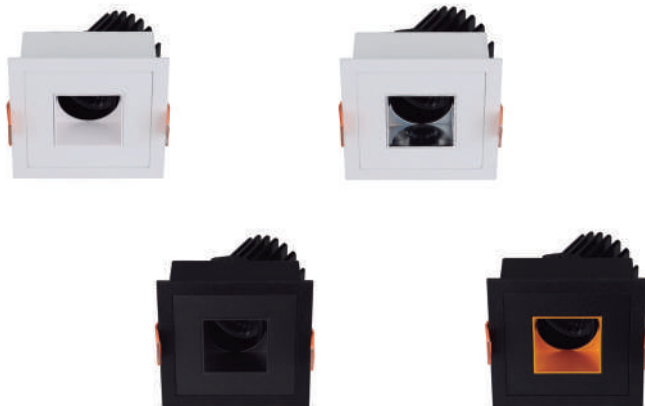

4,7W

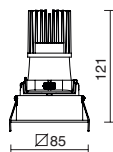

10,1W-11,8W

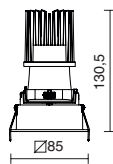

15,6W

## 1008A-

CRI >90		
4,7W	10,6W	15,6W
2700K 650lm	2700K 1317lm	2700K 1940lm
3000K 680lm	3000K 1376lm	3000K 2028lm
4000K 719lm	4000K 1456lm	4000K 2145lm

CRI >97
10,1W
2700K 923lm
3000K 949lm
4000K 1031lm

CRI >95 DTW
11,8W
2000K 28lm
3000K 1179lm

TUNNABLE WHITE
10,6W
2700K 1278lm
6500K 1563lm

 FILTERS p.59



Acabado blanco o negro con embellecedor blanco, negro, cromado u oro / White or black finish with white, black, chrome or gold baffle



-01-01   -01-02   -01-32   -01-47   -02-01   -02-02   -02-32   -02-47

- 9 - 10

Con Driver remoto  
With Remote Driver

Campos / Fields

Acabados/Finishes

<b>1</b>	<b>2</b>	<b>3</b>	<b>4</b>	<b>5</b>	<b>6</b>	<b>7</b>	<b>8</b>	<b>9</b>	<b>10</b>
----------	----------	----------	----------	----------	----------	----------	----------	----------	-----------

Familia Family	Modelo Model	Fuente de luz Lighting source	CRI / °K	Potencia (W) Power (W)	Voltaje Voltage	Óptica Light beam	Regulación Dimmable	Aro Ring	Embellecedor Baffle
-------------------	-----------------	----------------------------------	----------	---------------------------	--------------------	----------------------	------------------------	-------------	------------------------

<b>1</b>	<b>4</b>	<b>5</b>	<b>7</b>	<b>9</b>
1008 VIP 3	38 CRI90 2700K 39 CRI90 3000K 40 CRI90 4000K 53 CRI97 2700K 54 CRI97 3000K 55 CRI97 4000K 56 TUNABLE WHITE 2700-6500K 57 CRI95 DIM TO WARM 2000K-3000K	06 4,7W 13 10,1W- 11,8W 18 15,6W	1 18° 2 28° 3 38° 5 50°	01 □ 02 ■
<b>2</b>		<b>6</b>	<b>8</b>	<b>10</b>
A Square Square		A AC110-240V B AC220-240V	0 ON-OFF F L.C (Trailing and leading edge) 1 PUSH/1-10V D DALI M CASAMBI	01 □ 02 ■ 32 □ 47 ■
<b>3</b>				
L LED COB				

<b>1</b>	<b>2</b>	<b>3</b>	<b>4</b>	<b>5</b>	<b>6</b>	<b>7</b>	<b>8</b>	<b>9</b>	<b>10</b>
1008	A	L	38 39 40  53 54 55  56  57	06  13  18  13  13	A B B A A  B B A A B  B B A A B  A B B	1 2 3 5  1 2 3 5  1 2 3 5  1 2 3 5	0 0 F 1 D  0 F 1 D M  0 F 1 D M  D  1 D M	01 02	01 02 32 47

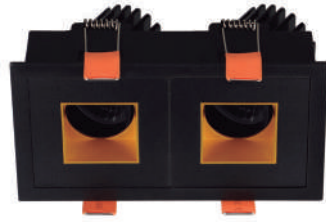

145x78

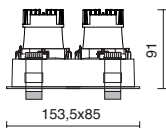

2x 4,7W

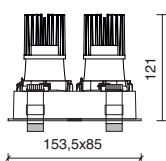

2x 10,1W-11,8W

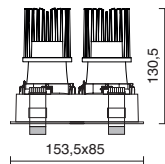

2x 15,6W

## 1008B-

CRI >90			CRI >97	CRI >95 DTW	TUNNABLE WHITE
2x 4,7W	2x 10,6W	2x 15,6W	2x 10,1W	2x 11,8W	2x 10,6W
2700K 2x 650lm	2700K 2x 1317lm	2700K 2x 1940lm	2700K 2x 923lm	2000K 2x 28lm	2700K 2x 1278lm
3000K 2x 680lm	3000K 2x 1376lm	3000K 2x 2028lm	3000K 2x 949lm	3000K 2x 1179lm	6500K 2x 1563lm
4000K 2x 719lm	4000K 2x 1456lm	4000K 2x 2145lm	4000K 2x 1031lm		

 FILTERS p.59



Acabado blanco o negro con embellecedor blanco, negro, cromado u oro / White or black finish with white, black, chrome or gold baffle



- 9  
- 10

Con Driver remoto  
With Remote Driver



# VIP 3

DOWNLIGHTS

Campos / Fields

Acabados/Finishes

<b>1</b>	<b>2</b>	<b>3</b>	<b>4</b>	<b>5</b>	<b>6</b>	<b>7</b>	<b>8</b>	<b>9</b>	<b>10</b>
----------	----------	----------	----------	----------	----------	----------	----------	----------	-----------

Familia Family	Modelo Model	Fuente de luz Lighting source	CRI / °K	Potencia (W) Power (W)	Voltaje Voltage	Óptica Light beam	Regulación Dimmable	Aro Ring	Embellecedor Baffle
-------------------	-----------------	----------------------------------	----------	---------------------------	--------------------	----------------------	------------------------	-------------	------------------------

<b>1</b>	<b>4</b>	<b>5</b>	<b>7</b>	<b>9</b>
1008 VIP 3	38 CRI90 2700K 39 CRI90 3000K 40 CRI90 4000K 53 CRI97 2700K 54 CRI97 3000K 55 CRI97 4000K 56 TUNABLE WHITE 2700-6500K 57 CRI95 DIM TO WARM 2000K-3000K	06 2x 4,7W 13 2x 10,1W- 11,8W 18 2x 15,6W	1 18° 2 28° 3 38° 5 50°	01 □ 02 ■
<b>2</b>		<b>6</b>	<b>8</b>	<b>10</b>
B 2x Square Square		A AC110-240V B AC220-240V	0 ON-OFF F L,C (Trailing and leading edge) 1 PUSH/1-10V D DALI M CASAMBI	01 □ 02 ■ 32 □ 47 ■
<b>3</b>				
L LED COB				

<b>1</b>	<b>2</b>	<b>3</b>	<b>4</b>	<b>5</b>	<b>6</b>	<b>7</b>	<b>8</b>	<b>9</b>	<b>10</b>
1008	B	L	38 39 40	06	A B B A A	1 2 3 5	O O F 1 D	01 02	01 02 32 47
				13	B B A A B	1 2 3 5	O F 1 D M		
				18	B B B B	1 2 3 5	O F 1 D M		
			53 54 55	13	B B A A B	1 2 3 5	O F 1 D M		
			56	13	B		D		
			57	13	A B B	1 2 3 5	1 D M		

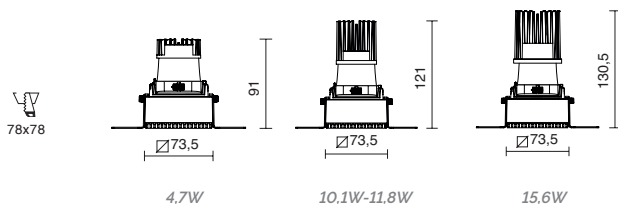
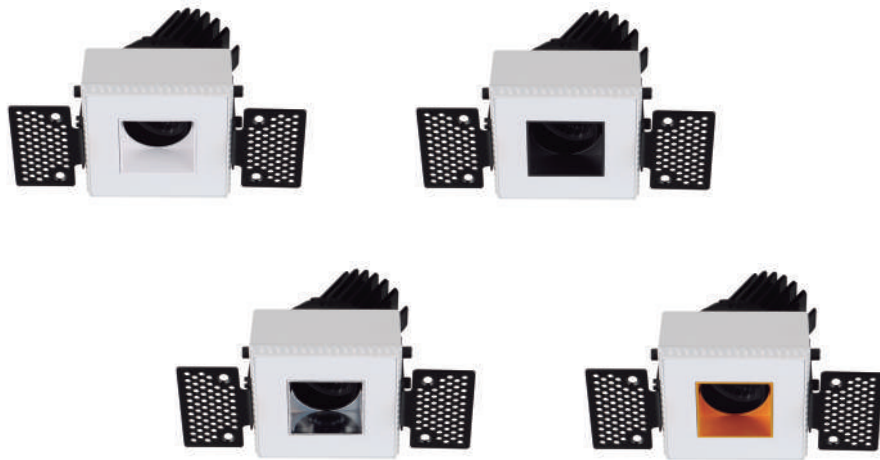

## 1011A-

CRI >90		
4,7W	10,6W	15,6W
2700K 650lm	2700K 1317lm	2700K 1940lm
3000K 680lm	3000K 1376lm	3000K 2028lm
4000K 719lm	4000K 1456lm	4000K 2145lm

CRI >97
10,1W
2700K 923lm
3000K 949lm
4000K 1031lm

CRI >95 DTW
11,8W
2000K 28lm
3000K 1179lm

TUNNABLE WHITE
10,6W
2700K 1278lm
6500K 1563lm

 FILTERS p.59



Acabado blanco con embellecedor blanco, negro, cromado u oro / White finish with white, black, chrome or gold baffle

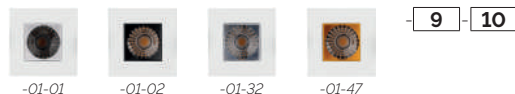

Con Driver remoto  
With Remote Driver

Campos / Fields

Acabados/Finishes

<b>1</b>	<b>2</b>	<b>3</b>	<b>4</b>	<b>5</b>	<b>6</b>	<b>7</b>	<b>8</b>	<b>9</b>	<b>10</b>
----------	----------	----------	----------	----------	----------	----------	----------	----------	-----------

Familia Family	Modelo Model	Fuente de luz Lighting source	CRI / °K	Potencia (W) Power (W)	Voltaje Voltage	Óptica Light beam	Regulación Dimmable	Aro Ring	Embelledor Baffle
-------------------	-----------------	----------------------------------	----------	---------------------------	--------------------	----------------------	------------------------	-------------	----------------------

<b>1</b>	<b>4</b>	<b>5</b>	<b>7</b>	<b>9</b>
1011 VIP 3T	38 CRI90 2700K 39 CRI90 3000K 40 CRI90 4000K 53 CRI97 2700K 54 CRI97 3000K 55 CRI97 4000K 56 TUNNABLE WHITE 2700K-6500K 57 CRI95 DIM TO WARM 2000K-3000K	06 4,7W 13 10,1W- 11,8W 18 15,6W	1 18° 2 28° 3 38° 5 50°	01 □
<b>2</b>		<b>6</b>	<b>8</b>	<b>10</b>
A Square Square		A AC110-240V B AC220-240V	0 ON-OFF F L.C (Trailing and leading edge) 1 PUSH/1-10V D DALI M CASAMBI	01 □ 02 ■ 32 ■ 47 ■
<b>3</b>				
L LED COB				

<b>1</b>	<b>2</b>	<b>3</b>	<b>4</b>	<b>5</b>	<b>6</b>	<b>7</b>	<b>8</b>	<b>9</b>	<b>10</b>
1011	A	L	38 39 40  53 54 55  56  57	06  13  18  13  13	A B B A A  B B A A B  B B A A B	1 2 3 5  1 2 3 5  1 2 3 5  1 2 3 5	0 0 F 1 D  0 F 1 D M  0 F 1 D M  1 1 D M	01	01 02 32 47



-01



-02



-30



-32



-45



-48

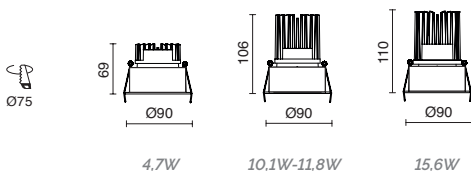

750A-

CRI >90		
4,7W	10,6W	15,6W
2700K 650lm	2700K 1317lm	2700K 1940lm
3000K 680lm	3000K 1376lm	3000K 2028lm
4000K 719lm	4000K 1456lm	4000K 2145lm

CRI >97
10,1W
2700K 923lm
3000K 949lm
4000K 1031lm

CRI >95 DTW
11,8W
2000K 28lm
3000K 1179lm

TUNNABLE WHITE
10,6W
2700K 1278lm
6500K 1563lm

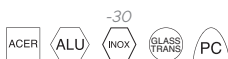
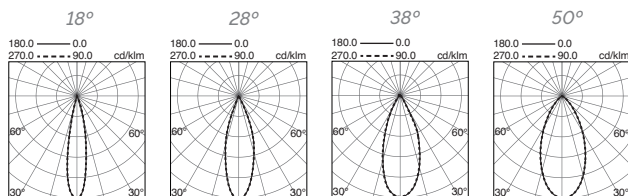

-30



Acabado blanco, negro, inox (-30), cromado (-32), cromado mate (-45) o níquel mate (-48)  
 White, black, stainless steel (-30), chrome (-32), matt chrome (-45) or matt nickel finish (-48)

Con Driver remoto  
 With Remote Driver

Campos / Fields

<b>1</b>	<b>2</b>	<b>3</b>	<b>4</b>	<b>5</b>	<b>6</b>	<b>7</b>	<b>8</b>	<b>9</b>
----------	----------	----------	----------	----------	----------	----------	----------	----------

Familia Family	Modelo Model	Fuente de luz Lighting source	CRI / °K	Potencia (W) Power (W)	Voltage Voltage	Óptica Light beam	Regulación Dimmable	Acabado Finish
-------------------	-----------------	----------------------------------	----------	---------------------------	--------------------	----------------------	------------------------	-------------------

<p><b>1</b></p> <p>750 PALMA</p> <hr/> <p><b>2</b></p> <p>A Fixed Round</p> <hr/> <p><b>3</b></p> <p>L LED COB</p>	<p><b>4</b></p> <p>38 CRI90 2700K 39 CRI90 3000K 40 CRI90 4000K 53 CRI97 2700K 54 CRI97 3000K 55 CRI97 4000K 56 TUNABLE WHITE 2700-6500K 57 CRI95 DIM TO WARM 2000K-3000K</p>	<p><b>5</b></p> <p>06 4,7W 13 10,1W- 11,8W 18 15,6W</p> <hr/> <p><b>6</b></p> <p>A AC110-240V B AC220-240V</p>	<p><b>7</b></p> <p>1 18° 2 28° 3 38° 5 50°</p> <hr/> <p><b>8</b></p> <p>0 ON-OFF F L.C (Trailing and leading edge) 1 PUSH/1-10V D DALI M CASAMBI</p>	<p><b>9</b></p> <p>01 □ 02 ■ 30 □ 32 □ 45 □ 48 □</p>
--	---	--	--	--

1	2	3	4	5	6	7	8	9	
750	A	L	38 39 40	06	A		O		01 02 30 32 45 48
					B	1	O		
					B	2	F		
					A	3	1		
					A	5	D		
					A		D		
				53 54 55	13	B		O	
						B	1	F	
						A	2	1	
						A	3	D	
						A	5	D	
						B		M	
			56	13	B		O		
					B	1	F		
					B	2	1		
					B	3	D		
					B	5	D		
					B		M		
			57	13	A	1	1		
					B	2	D		
					B	3	D		
						5	M		

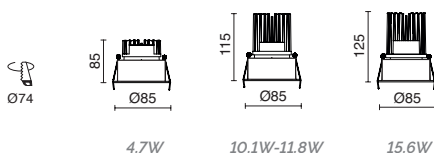
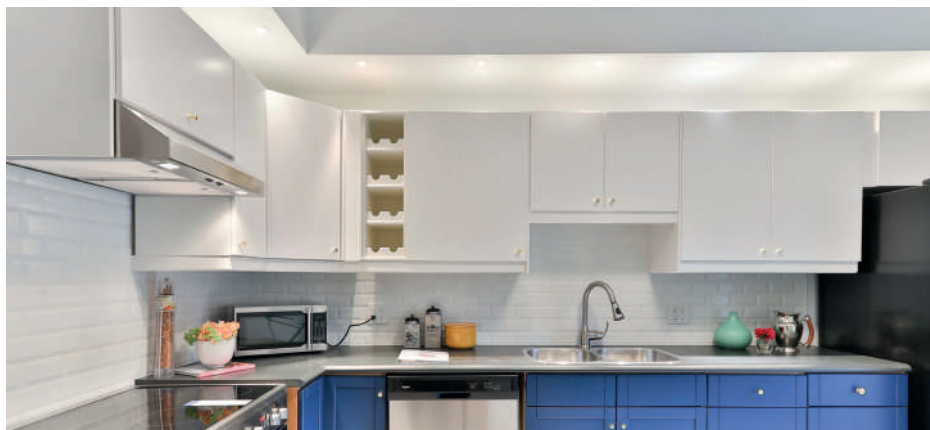

781B-

CRI >90		
4,7W	10,6W	15,6W
2700K 650lm	2700K 1317lm	2700K 1940lm
3000K 680lm	3000K 1376lm	3000K 2028lm
4000K 719lm	4000K 1456lm	4000K 2145lm

CRI >97
10,1W
2700K 923lm
3000K 949lm
4000K 1031lm

CRI >95 DTW
11,8W
2000K 28lm
3000K 1179lm

TUNNABLE WHITE
10,6W
2700K 1278lm
6500K 1563lm

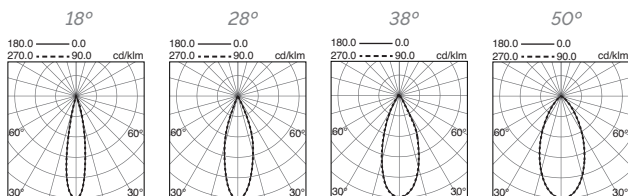

Acabado blanco / White finish

Con Driver remoto  
With Remote Driver

Campos / Fields

<b>1</b>	<b>2</b>	<b>3</b>	<b>4</b>	<b>5</b>	<b>6</b>	<b>7</b>	<b>8</b>	<b>9</b>
----------	----------	----------	----------	----------	----------	----------	----------	----------

Familia Family	Modelo Model	Fuente de luz Lighting source	CRI / °K	Potencia (W) Power (W)	Voltage Voltage	Óptica Light beam	Regulación Dimmable	Acabado Finish
-------------------	-----------------	----------------------------------	----------	---------------------------	--------------------	----------------------	------------------------	-------------------

<b>1</b>	<b>4</b>	<b>5</b>	<b>7</b>	<b>9</b>
781 CARPO	38 CRI90 2700K 39 CRI90 3000K 40 CRI90 4000K 53 CRI97 2700K 54 CRI97 3000K 55 CRI97 4000K	06 4,7W 13 10,1W- 11,8W 18 15,6W	1 18° 2 28° 3 38° 5 50°	01 □
<b>2</b>		<b>6</b>	<b>8</b>	
B Fixed Round	56 TUNABLE WHITE 2700-6500K 57 CRI95 DIM TO WARM 2000K-3000K	A AC110-240V B AC220-240V	0 ON-OFF F LC (Trailing and leading edge) 1 PUSH/1-10V D DALI M CASAMBI	
<b>3</b>				
L LED COB				

1	2	3	4	5	6	7	8	9
781	B	L	38 39 40	06	A		O	01
					B	1	O	
					B	2	F	
					A	3	1	
					A	5	D	
					A		D	
				53 54 55	13	B		O
						B	1	F
						A	2	1
						A	3	D
						A	5	M
						B		M
			56	13	B		O	
					B	1	F	
					B	2	1	
					B	3	D	
					B	5	M	
					B		M	
			57	13	B		O	
					A	1	F	
					B	2	1	
					B	3	D	
					B	5	M	
					B		M	

# MINI LUNA

DOWNLIGHTS

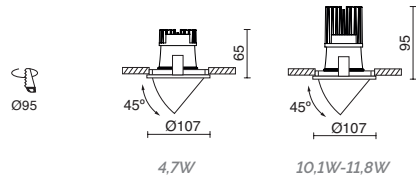

741A-

CRI >90			
4,7W		10,6W	
2700K	650lm	2700K	1317lm
3000K	680lm	3000K	1376lm
4000K	719lm	4000K	1456lm

CRI >97	
10,1W	
2700K	923lm
3000K	949lm
4000K	1031lm

CRI >95 DTW	
11,8W	
2000K	28lm
3000K	1179lm

TUNNABLE WHITE	
10,6W	
2700K	1278lm
6500K	1563lm



Acabado blanco, negro, gris, cromo, cromo mate o níquel mate / White, black, grey, chrome, matt chrome or matt nickel finish

Con Driver remoto  
With Remote Driver



# MINI LUNA

DOWNLIGHTS

Campos / Fields

<b>1</b>	<b>2</b>	<b>3</b>	<b>4</b>	<b>5</b>	<b>6</b>	<b>7</b>	<b>8</b>	<b>9</b>
----------	----------	----------	----------	----------	----------	----------	----------	----------

Familia Family	Modelo Model	Fuente de luz Lighting source	CRI / °K	Potencia (W) Power (W)	Voltage Voltage	Óptica Light beam	Regulación Dimmable	Acabado Finish
-------------------	-----------------	----------------------------------	----------	---------------------------	--------------------	----------------------	------------------------	-------------------

<p><b>1</b></p> <p>741 MINI LUNA</p> <hr/> <p><b>2</b></p> <p>A Adjustable Round</p> <hr/> <p><b>3</b></p> <p>L LED</p>	<p><b>4</b></p> <p>38 CRI90 2700K 39 CRI90 3000K 40 CRI90 4000K 53 CRI97 2700K 54 CRI97 3000K 55 CRI97 4000K 56 TUNABLE WHITE 2700-6500K 57 CRI95 DIM TO WARM 2000K-3000K</p>	<p><b>5</b></p> <p>06 4,7W 13 10,1W- 11,8W</p> <hr/> <p><b>6</b></p> <p>A AC110-240V B AC220-240V</p>	<p><b>7</b></p> <p>1 18° 2 28° 3 38° 5 50°</p> <hr/> <p><b>8</b></p> <p>O ON-OFF L C F (Trailing and leading edge) 1 PUSH/1-10V D DALI M CASAMBI</p>	<p><b>9</b></p> <p>01 <input type="checkbox"/> 02 <input checked="" type="checkbox"/> 03 <input type="checkbox"/> 32 <input type="checkbox"/> 45 <input type="checkbox"/> 48 <input type="checkbox"/></p>
---	---	---	--	---

<b>1</b>	<b>2</b>	<b>3</b>	<b>4</b>	<b>5</b>	<b>6</b>	<b>7</b>	<b>8</b>	<b>9</b>
741	A	L	38 39 40	06	A B B A A	1 2 3 5	O O F 1 D	01 02 03 32 45 48
			53 54 55	13	B B A A B	1 2 3 5	O F 1 D M	
			56	13	B		D	
			57	13	A B B	1 2 3 5	1 D M	

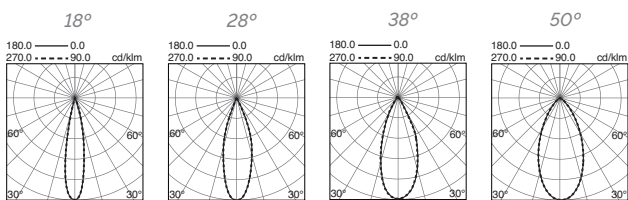

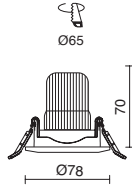

780A-

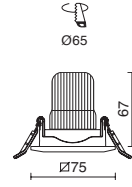

780B-

**6,2W**

3000K 734lm

4000K 797lm

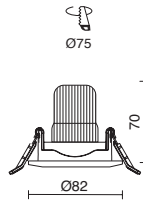

780E-

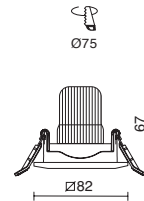

780F-

**6,2W**

3000K 734lm

4000K 797lm

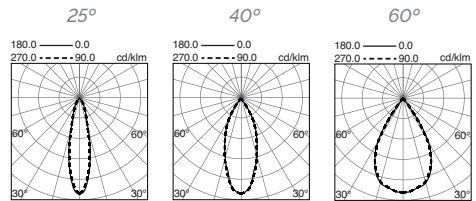

Acabado blanco, cromado mate o niquel mate / White chrome, matt chrome or matt nickel finish

Con Driver remoto  
With Remote Driver

Campos / Fields

<b>1</b>	<b>2</b>	<b>3</b>	<b>4</b>	<b>5</b>	<b>6</b>	<b>7</b>	<b>8</b>	<b>9</b>
----------	----------	----------	----------	----------	----------	----------	----------	----------

Familia  
Family

Modelo  
Model

Fuente de luz  
Lighting source

CRI / °K

Potencia (W)  
Power (W)

Voltage  
Voltage

Óptica  
Light beam

Regulación  
Dimmable

Acabado  
Finish

## 1

780 NIX

## 2

- A Fixed round
- B Fixed square
- E Adjustable round
- F Adjustable square

## 3

L LED

## 4

39 CRI90 3000K  
40 CRI90 4000K

## 5

08 6,2W

## 6

- A AC110-240V
- B AC220-240V

## 7

2 25°  
4 40°  
6 60°

## 8

- O ON-OFF
- F L.C  
(Trailing and leading edge)
- 1 PUSH/1-10V
- D DALI

## 9

01   
45   
48

1	2	3	4	5	6	7	8	9
780	A	L	39 40	08	A		O	01 45 48
	B				2	F		
	A				4	1		
	A				6	D		
	A					O		
	B				2	F		
	A				4	1		
	A				6	D		
	A					O		
	B				2	F		
	A				4	1		
	A				6	D		
	A					O		
	B				2	F		
	A				4	1		
	A				6	D		



A13A-

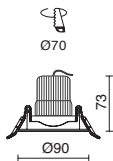

A13B-

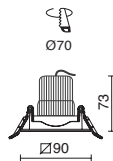

6,2W

3000K 734lm  
4000K 797lm



A13C-

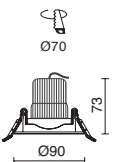

A13D-

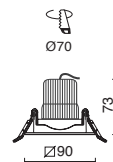

6,2W

3000K 734lm  
4000K 797lm

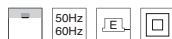
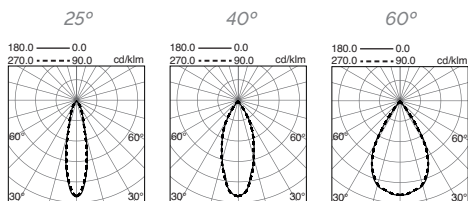

Acabado blanco / White finish

Con Driver remoto  
With Remote Driver

Campos / Fields

<b>1</b>	<b>2</b>	<b>3</b>	<b>4</b>	<b>5</b>	<b>6</b>	<b>7</b>	<b>8</b>	<b>9</b>
----------	----------	----------	----------	----------	----------	----------	----------	----------

Familia  
Family

Modelo  
Model

Fuente de luz  
Lighting source

CRI / °K

Potencia (W)  
Power (W)

Voltage  
Voltage

Óptica  
Light beam

Regulación  
Dimmable

Acabado  
Finish

**1**

A13 INEL

**2**

- A Fixed round
- B Fixed square
- C Adjustable round
- D Adjustable square

**3**

L LED

**4**

39 CRI90 3000K  
40 CRI90 4000K

**5**

08 6,2W

**6**

- A AC110-240V
- B AC220-240V

**7**

2 25°  
4 40°  
6 60°

**8**

- 0 ON-OFF  
L.C  
(Trailing and  
leading edge)
- 1 PUSH/1-10V
- D DALI

**9**

01 □

<b>1</b>	<b>2</b>	<b>3</b>	<b>4</b>	<b>5</b>	<b>6</b>	<b>7</b>	<b>8</b>	<b>9</b>
A13	A	L	39 40	08	A	2 4 6	O	01
					B		F	
					A		1	
					A		D	
	B				A	O		
					B	F		
					A	1		
					A	D		
	C				A	O		
					B	F		
					A	1		
					A	D		
	D				A	O		
					B	F		
					A	1		
					A	D		

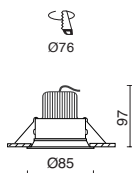

6.2W

3000K 734lm  
4000K 797lm

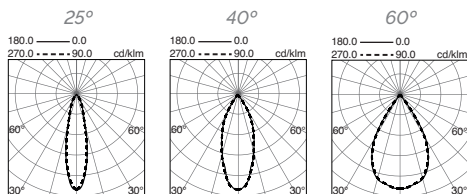

Acabado blanco, negro o gris / White, black or grey finish

Con Driver remoto  
With Remote Driver

Campos / Fields

<b>1</b>	<b>2</b>	<b>3</b>	<b>4</b>	<b>5</b>	<b>6</b>	<b>7</b>	<b>8</b>	<b>9</b>
----------	----------	----------	----------	----------	----------	----------	----------	----------

Familia Family    Modelo Model    Fuente de luz Lighting source    CRI / °K    Potencia (W) Power (W)    Voltage Voltage    Óptica Light beam    Regulación Dimmable    Acabado Finish

<b>1</b> 752 LEDA	<b>2</b> A Adjustable round	<b>3</b> L LED	<b>4</b> 39 CRI90 + 3000K 40 CRI90 + 4000K	<b>5</b> 08 6.2W	<b>6</b> A AC110-240V B AC220-240V	<b>7</b> 2 25° 4 40° 6 60°	<b>8</b> O ON-OFF F L.C (Trailing and leading edge) 1 PUSH/1-10V D DALI	<b>9</b> 01 02 03
----------------------	--------------------------------	-------------------	--	---------------------	--	-------------------------------------	--	----------------------------

<b>1</b>	<b>2</b>	<b>3</b>	<b>4</b>	<b>5</b>	<b>6</b>	<b>7</b>	<b>8</b>	<b>9</b>
752	A	L	39 40	08	A B A A	2 4 6	O F 1 D	01 02 03

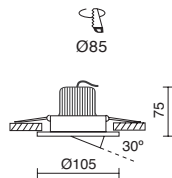

6,2W

3000K 734lm  
4000K 797lm

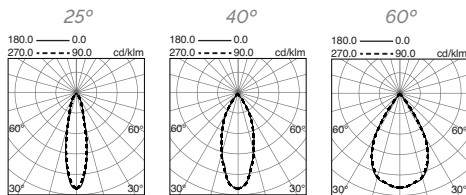

Acabado blanco / White finish

Con Driver remoto  
With Remote Driver

Campos / Fields

1	2	3	4	5	6	7	8	9
Familia Family	Modelo Model	Fuente de luz Lighting source	CRI / °K	Potencia (W) Power (W)	Voltage Voltage	Óptica Light beam	Regulación Dimmable	Acabado Finish
1	2	3	4	5	6	7	8	9
749 KOS		39 CRI90 3000K 40 CRI90 4000K		08 6.2W		2 25° 4 40° 6 60°		01 □
2	B Adjustable round			6	A AC110-240V B AC220-240V		8	
3	L LED						0 ON-OFF F L.C (Trailing and leading edge) 1 PUSH/1-10V D DALI	

1	2	3	4	5	6	7	8	9
749	B	L	39 40	08	A B A A	2 4 6	O F 1 D	01



798A-

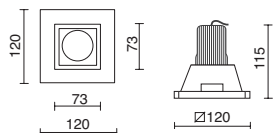

TRIMLESS



124x124



798B-

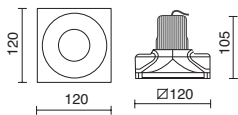

TRIMLESS



124x124



798C-

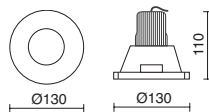

TRIMLESS



Ø133

6,2W

3000K 734lm

4000K 797lm

9<15 mm

Para techo de yeso / For plaster ceiling

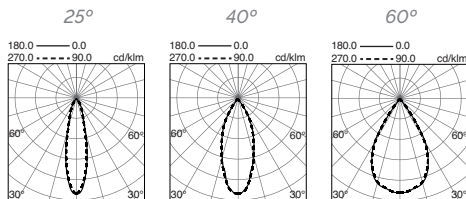
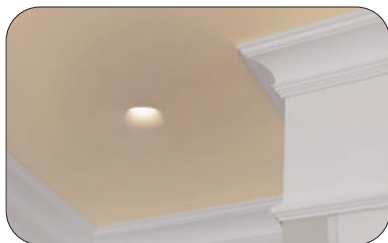

Acabado blanco / White finish

Con Driver remoto  
With Remote Driver



Campos / Fields

1	2	3	4	5	6	7	8	9
Familia Family	Modelo Model	Fuente de luz Lighting source	CRI / °K	Potencia (W) Power (W)	Voltage Voltage	Óptica Light beam	Regulación Dimmable	Acabado Finish

**1**

798 LEN

**2**

A Square  
B Square round  
C Round

**3**

L LED COB

**4**

39 CRI90 3000K  
40 CRI90 4000K

**5**

08 6,2W

**6**

A AC110-240V  
B AC220-240V

**7**

2 25°  
4 40°  
6 60°

**8**

O ON-OFF  
L L.C  
(Trailing and leading edge)  
1 PUSH/1-10V  
D DALI

**9**

01 □

1	2	3	4	5	6	7	8	9
798	A	L	39 40	08	A	2 4 6	O	01
	B				F			
	A				1			
	A				D			
	A				O			
	B				F			
	A				1			
	A				D			
	A				O			
	B				F			
	A				1			
	A				D			

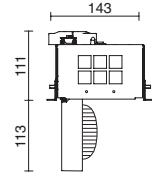

**3000K**  
LED COB 17W 2180lm

- 738Q-L3125B-01
- 738Q-L3125B-02
- 738Q-L3125B-03

**4000K**  
LED COB 17W 2250lm

- 738Q-L3325B-01
- 738Q-L3325B-02
- 738Q-L3325B-03

- 738Q-L31R2B-01
- 738Q-L31R2B-02
- 738Q-L31R2B-03

- 738Q-L33R2B-01
- 738Q-L33R2B-02
- 738Q-L33R2B-03



- 738Q-L3117B1M-01
- 738Q-L3117B1M-02
- 738Q-L3117B1M-03

- 738Q-L3317B1M-01
- 738Q-L3317B1M-02
- 738Q-L3317B1M-03

**CASAMBI**



**3000K**  
LED COB 17W 2210lm

- 738R-L3125B-01
- 738R-L3125B-02
- 738R-L3125B-03

**4000K**  
LED COB 17W 2280lm

- 738R-L3325B-01
- 738R-L3325B-02
- 738R-L3325B-03

- 738R-L31R2B-01
- 738R-L31R2B-02
- 738R-L31R2B-03

- 738R-L33R2B-01
- 738R-L33R2B-02
- 738R-L33R2B-03



- 738R-L3117B2M-01
- 738R-L3117B2M-02
- 738R-L3117B2M-03

- 738R-L3317B1M-01
- 738R-L3317B1M-02
- 738R-L3317B1M-03

**CASAMBI**

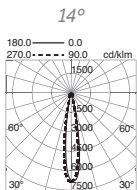

3000K			
h (m)	d (m)	E (lux)	
1,00	0,29	12485	
2,00	0,58	3121	
3,00	0,87	1387	
4,00	1,16	780	
5,00	1,45	499	

4000K			
h (m)	d (m)	E (lux)	
1,00	0,29	14782	
2,00	0,58	3696	
3,00	0,87	1642	
4,00	1,16	924	
5,00	1,45	591	

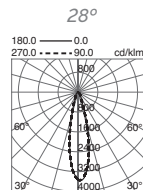

3000K			
h (m)	d (m)	E (lux)	
1,00	0,54	6537	
2,00	1,08	1634	
3,00	1,62	726	
4,00	2,16	409	
5,00	2,70	261	



4000K			
h (m)	d (m)	E (lux)	
1,00	0,54	7027	
2,00	1,08	1757	
3,00	1,62	781	
4,00	2,16	439	
5,00	2,70	281	



Acabado blanco, negro o gris / White, black or grey finish

Con Driver remoto  
With Remote Driver

Marcos / Frames





	<ul style="list-style-type: none"> <li>□ A45A-738-01</li> <li>■ A45A-738-02</li> <li>■ A45A-738-03</li> </ul>		152x152	
	<ul style="list-style-type: none"> <li>□ A45B-738-01</li> <li>■ A45B-738-02</li> <li>■ A45B-738-03</li> </ul>		300x152	
	<ul style="list-style-type: none"> <li>□ A45C-738-01</li> <li>■ A45C-738-02</li> <li>■ A45C-738-03</li> </ul>		450x152	
	<ul style="list-style-type: none"> <li>□ A45D-738-01</li> <li>■ A45D-738-02</li> <li>■ A45D-738-03</li> </ul>		600x152	
	<ul style="list-style-type: none"> <li>□ A45E-738-01</li> <li>■ A45E-738-02</li> <li>■ A45E-738-03</li> </ul>		300x300	

ACER

Acabado blanco, negro o gris / White, black or grey finish





Filtros de conversión para pescado, marisco, verdura, carne o pan  
Conversion for fish, seafood, vegetables, meat or bread

	SEAFOOD	A14A-738-00	<i>for 3000K</i>
	VEG+FRUIT	A14A-738-00	
<hr/>			
	FISH	A14A-738-00	<i>for 4000K</i>
	MEAT	A14B-738-00	
	BREAD	A14C-738-00	



Porta filtros / Support for filters

	<ul style="list-style-type: none"> <li>□ A44A-772-01</li> <li>■ A44A-772-02</li> <li>■ A44A-772-03</li> </ul>	
---	---	--

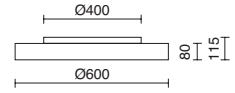

**3000K**

LED SMD 44W 3980lm

- 801A-L3148B-01
- 801A-L3148B-02

**4000K**

LED SMD 44W 4563lm

- 801A-L3348B-01
- 801A-L3348B-02



- 801A-L31RDB-01
- 801A-L31RDB-02

- 801A-L33RDB-01
- 801A-L33RDB-02

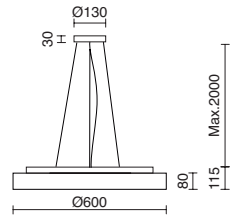

**3000K**

LED SMD 44W 3980lm

- 801C-L3148B-01
- 801C-L3148B-02

**4000K**

LED SMD 44W 4563lm

- 801C-L3348B-01
- 801C-L3348B-02



- 801C-L31RDB-01
- 801C-L31RDB-02

- 801C-L33RDB-01
- 801C-L33RDB-02

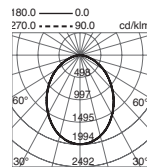

801A / 801C		
h (m)	d (m)	E (lux)
1,00	3,45	1535
2,00	6,90	384
3,00	10,35	171
4,00	13,80	96
5,00	17,25	61

801A / 801C		
h (m)	d (m)	E (lux)
1,00	3,45	1760
2,00	6,90	440
3,00	10,35	196
4,00	13,80	110
5,00	17,25	70



Acabado blanco o negro / White or negro finish

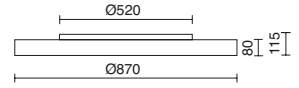

**3000K**  
LED SMD 96W 7944lm

**4000K**  
LED SMD 96W 9108lm

- 801B-L31A3B-01
- 801B-L31A3B-02

- 801B-L33A3B-01
- 801B-L33A3B-02



- 801B-L31RDB-01
- 801B-L31RDB-02

- 801B-L33RDB-01
- 801B-L33RDB-02

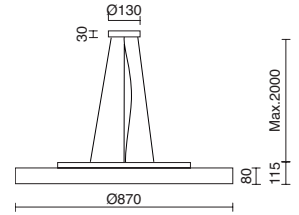

**3000K**  
LED SMD 96W 7944lm

**4000K**  
LED SMD 96W 9108lm

- 801D-L31A3B-01
- 801D-L31A3B-02

- 801D-L33A3B-01
- 801D-L33A3B-02



- 801D-L31RDB-01
- 801D-L31RDB-02

- 801D-L33RDB-01
- 801D-L33RDB-02

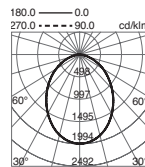

801B / 801D			801B / 801D		
h (m)	d (m)	E (lux)	h (m)	d (m)	E (lux)
1,00	2,75	3064	1,00	2,75	4073
2,00	5,50	766	2,00	5,50	1018
3,00	8,25	341	3,00	8,25	453
4,00	11,00	191	4,00	11,00	255
5,00	13,75	122	5,00	13,75	163



Acabado blanco o negro / White or negro finish



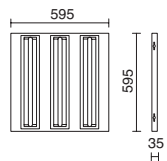

<b>3000K</b> LED SMD 45W 3939lm	<b>4000K</b> LED SMD 45W 4210lm
<input type="checkbox"/> 783A-L3145B-01	<input type="checkbox"/> 783A-L3345B-01
<input type="checkbox"/> 783A-L31R2B-01	<input type="checkbox"/> 783A-L33R2B-01
<input type="checkbox"/> 783A-L3145ABM-01	<input type="checkbox"/> 783A-L3345ABM-01



CASAMBI

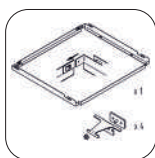

Kit de superficie  
Surface mounted kit

A20B-783-01

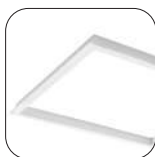
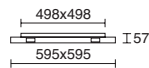

Marco para techo continuo  
Frame for continuous ceilings

A20C-804-01

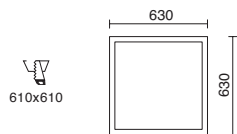

Kit de suspensión (L=2m)  
Suspension kit (L=2m)

A20A-783-39

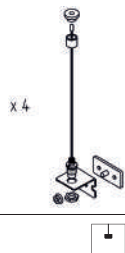

Acabado blanco / White finish

Con Driver remoto  
With Remote Driver





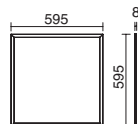

**3000K**

LED SMD 42W 3700lm

804A-L3142B-01

804A-L31RDB-01

804A-L3142A9M-01

**4000K**

LED SMD 42W 3900lm

804A-L3342B-01

804A-L33RDB-01

804A-L3342A9M-01



CASAMBI



**Kit de superficie**  
**Surface mounted kit**

A20B-583-01

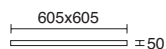

**Marco para techo continuo**  
**Frame for continuous ceilings**

A20C-804-01

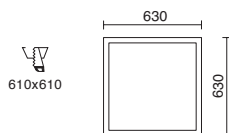

**Kit de suspensión (L=2m)**  
**Suspension kit (L=2m)**

A20B-804-38



Acabado blanco / White finish

Con Driver remoto  
With Remote Driver



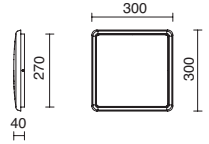

**3000K**  
LED SMD 18W 1494lm

**4000K**  
LED SMD 18W 1584lm

□ 806B-L31RCB-01

□ 806B-L33RCB-01

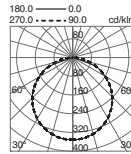

**806B-L31RCB**

h (m)	d (m)	E (lux)
1,00	3,15	518
2,00	6,30	130
3,00	9,45	58
4,00	12,60	32
5,00	15,75	21

**806B-L33RCB**

h (m)	d (m)	E (lux)
1,00	3,15	550
2,00	6,30	138
3,00	9,45	61
4,00	12,60	34
5,00	15,75	22

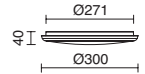

**3000K**  
LED SMD 18W 1530lm

**4000K**  
LED SMD 18W 1600lm

□ 806A-L31RCA-01

□ 806A-L33RCA-01



□ 806A-L3118Z-01

□ 806A-L3318Z-01



□ 806A-L3118R-01

□ 806A-L3318R-01



*EMERGENCY (3h) 4W 340lm*

*EMERGENCY (3h) 4W 355lm*

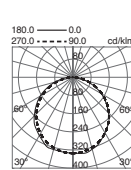

**806A-L31RCA**  
**806A-L3118Z**  
**806A-L3118R**

h (m)	d (m)	E (lux)
1,00	3,15	516
2,00	6,30	129
3,00	9,45	57
4,00	12,60	32
5,00	15,75	21

**806A-L33RCA**  
**806A-L3318Z**  
**806A-L3318R**

h (m)	d (m)	E (lux)
1,00	3,15	540
2,00	6,30	135
3,00	9,45	60
4,00	12,60	34
5,00	15,75	22



Acabado blanco / White finish

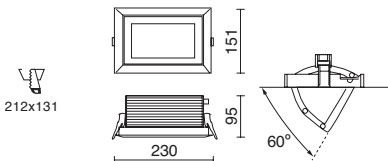

**3000K**  
LED COB 42W 3650lm

**4000K**  
LED COB 42W 3650lm

□ 759A-L3142B-01

□ 759A-L3342B-01

CRI >82

□ 759A-L31R2B-01

□ 759A-L33R2B-01

CRI >82

PUSH



□ 759A-L3142ASM-01

□ 759A-L3342ASM-01

CRI >82

CASAMBI

Filtros de conversión para pescado, ropa, verdura, carne o pan  
Conversion for fish, clothing, vegetables, meat or bread



**MEAT**  
LED COB 42W 2734lm



**BREAD**  
LED COB 42W 4267lm



**FISH**  
LED COB 42W 4739lm

□ 759A-L4442B-01

□ 759A-L4642B-01

□ 759A-L4742B-01

CRI >90



**VEG+FRUIT**  
LED COB 42W 5654lm



**FASHION**  
LED COB 42W 4268lm

□ 759A-L4842B-01

□ 759A-L5142B-01

CRI >90

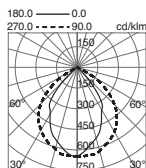

**759A-L3142**

**759A-L3342B**

759A-L3142				759A-L3342B			
h (m)	d (m)	d (m)	E (lux)	h (m)	dH (m)	dV (m)	E (lux)
1,00	1,35	2,25	2480	1,00	1,35	2,25	2700
2,00	2,70	4,50	620	2,00	2,70	4,50	675
3,00	4,05	6,75	276	3,00	4,05	6,75	300
4,00	5,40	9,00	155	4,00	5,40	9,00	169
5,00	6,75	11,25	99	5,00	6,75	11,25	108



Acabado blanco / White finish

Con Driver remoto  
With Remote Driver



### 3000K

LED COB 14W 1200lm

- 805A-L3115B-01
- 805A-L3115B-03

LED COB 24W 2320lm

- 805B-L3125B-01
- 805B-L3125B-03

LED COB 32W 3320lm

- 805C-L3135B-01
- 805C-L3135B-03

### 4000K

LED COB 14W 1280lm

- 805A-L3315B-01
- 805A-L3315B-03

LED COB 24W 2420lm

- 805B-L3325B-01
- 805B-L3325B-03

LED COB 32W 3430lm

- 805C-L3335B-01
- 805C-L3335B-03

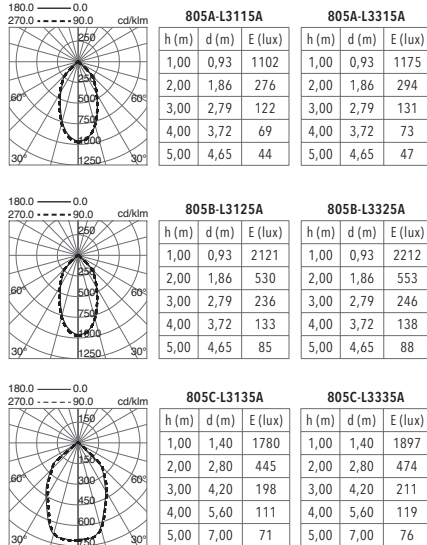

Acabado blanco o gris / White or grey finish



# Linear lights







*Biblioteca de la Universidad de Málaga*



Wall



2	*	(A) 581mm	(B) 861mm	(C) 1141mm	(D) 1431mm	(E) 1711mm	(F) 1991mm	(G) 2271mm
5		(12) 11.65W	(18) 17.50W	(24) 23.30W	(30) 29.15W	(35) 34.95W	(41) 40.80W	(47) 46.60W
4	(30) CR80 2700K	1905lm	2855lm	3810lm	4760lm	5715lm	6665lm	7620lm
	(31) CR80 3000K	1960lm	2940lm	3920lm	4900lm	5880lm	6860lm	7840lm
	(33) CR80 4000K	2070lm	3105lm	4140lm	5175lm	6210lm	7245lm	8280lm
	(39) CR90 3000K	1670lm	2505lm	3340lm	4175lm	5010lm	5845lm	6680lm
	(40) CR90 4000K	1745lm	2620lm	3490lm	4365lm	5235lm	6110lm	6980lm



Acabado blanco, negro o gris / White, black or grey finish

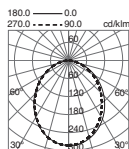

Ceiling	Recessed	Recessed Trimless	Pendant Dir	Pendant Dir/Indir.
p. 108	p. 110	p. 112	p. 114	p. 116

Campos / Fields

Acabados/Finishes

<b>1</b>	<b>2</b>	<b>3</b>	<b>4</b>	<b>5</b>	<b>6</b>	<b>7</b>	<b>8</b>	<b>9</b>
----------	----------	----------	----------	----------	----------	----------	----------	----------

<i>Familia</i> <i>Family</i>	<i>Modelo</i> <i>Model</i>	<i>Fuente de luz</i> <i>Lighting source</i>	<i>CRI / °K</i>	<i>Potencia (W)</i> <i>Power (W)</i>	<i>Voltaje</i> <i>Voltage</i>	<i>Óptica</i> <i>Light beam</i>	<i>Regulación</i> <i>Dimmable</i>	<i>Aro</i> <i>Ring</i>
---------------------------------	-------------------------------	--	-----------------	---	----------------------------------	------------------------------------	--------------------------------------	---------------------------

<b>1</b>	<b>3</b>	<b>5</b>	<b>6</b>	<b>8</b>
1066 <i>Fenix</i> <i>Wall</i>	L <i>LED COB</i>	12 <i>11,65W</i> 18 <i>17,50W</i> 24 <i>23,30W</i> 30 <i>29,15W</i> 35 <i>34,95W</i> 31 <i>CRI80 3000K</i> 41 <i>40,80W</i> 33 <i>CRI80 4000K</i> 39 <i>CRI90 3000K</i> 47 <i>46,60W</i> 40 <i>CRI90 4000K</i>	A <i>AC110-240V</i>	O <i>ON-OFF</i> D <i>DALI</i>
<b>2</b>	<b>4</b>	<b>7</b>	<b>9</b>	
A <i>581mm</i> B <i>861mm</i> C <i>1141mm</i> D <i>1431mm</i> E <i>1711mm</i> F <i>1991mm</i> G <i>2271mm</i>	30 <i>CRI80 2700K</i> 31 <i>CRI80 3000K</i> 33 <i>CRI80 4000K</i> 39 <i>CRI90 3000K</i> 40 <i>CRI90 4000K</i>	A <i>108°</i>	O1 <input type="checkbox"/> O2 <input checked="" type="checkbox"/> O3 <input checked="" type="checkbox"/>	

<b>1</b>	<b>2</b>	<b>3</b>	<b>4</b>	<b>5</b>	<b>6</b>	<b>7</b>	<b>8</b>	<b>9</b>
1066	A B C D E F G	L	30 31 33 39 40	12 18 24 30 35 41 47	A	A	O D	O1 O2 O3

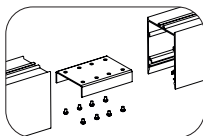

Unión línea continua / Continuous line connection

A58E-1061-41





2	*	(A) 581mm	(B) 861mm	(C) 1141mm	(D) 1431mm	(E) 1711mm	(F) 1991mm	(G) 2271mm
5		(12) 11.65W	(18) 17.50W	(24) 23.30W	(30) 29.15W	(35) 34.95W	(41) 40.80W	(47) 46.60W
4	(30) CR80 2700K	1905lm	2855lm	3810lm	4760lm	5715lm	6665lm	7620lm
	(31) CR80 3000K	1960lm	2940lm	3920lm	4900lm	5880lm	6860lm	7840lm
	(33) CR80 4000K	2070lm	3105lm	4140lm	5175lm	6210lm	7245lm	8280lm
	(39) CR90 3000K	1670lm	2505lm	3340lm	4175lm	5010lm	5845lm	6680lm
	(40) CR90 4000K	1745lm	2620lm	3490lm	4365lm	5235lm	6110lm	6980lm



Acabado blanco, negro o gris / White, black or grey finish

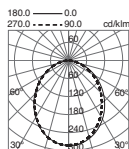

Wall (Down)	Recessed	Recessed Trimless	Pendant Dir	Pendant Dir/Indir.
p. 106	p. 110	p. 112	p. 114	p. 116

Campos / Fields

Acabados/Finishes

<b>1</b>	<b>2</b>	<b>3</b>	<b>4</b>	<b>5</b>	<b>6</b>	<b>7</b>	<b>8</b>	<b>9</b>
----------	----------	----------	----------	----------	----------	----------	----------	----------

<i>Familia</i> <i>Family</i>	<i>Modelo</i> <i>Model</i>	<i>Fuente de luz</i> <i>Lighting source</i>	<i>CRI / °K</i>	<i>Potencia (W)</i> <i>Power (W)</i>	<i>Voltaje</i> <i>Voltage</i>	<i>Óptica</i> <i>Light beam</i>	<i>Regulación</i> <i>Dimmable</i>	<i>Aro</i> <i>Ring</i>
---------------------------------	-------------------------------	--	-----------------	---	----------------------------------	------------------------------------	--------------------------------------	---------------------------

<b>1</b>	<b>3</b>	<b>5</b>	<b>6</b>	<b>8</b>
1062 <i>Fenix Ceiling</i>	L <i>LED COB</i>	12 11,65W 18 17,50W 24 23,30W 30 29,15W 35 34,95W 41 40,80W 47 46,60W	A AC110-240V	O ON-OFF D DALI
<b>2</b>	<b>4</b>	<b>7</b>	<b>9</b>	
A 581mm B 861mm C 1141mm D 1431mm E 1711mm F 1991mm G 2271mm	30 CRI80 2700K 31 CRI80 3000K 33 CRI80 4000K 39 CRI90 3000K 40 CRI90 4000K	A 108°	O1 <input type="checkbox"/> O2 <input checked="" type="checkbox"/> O3 <input checked="" type="checkbox"/>	

<b>1</b>	<b>2</b>	<b>3</b>	<b>4</b>	<b>5</b>	<b>6</b>	<b>7</b>	<b>8</b>	<b>9</b>
1062	A B C D E F G	L	30 31 33 39 40	12 18 24 30 35 41 47	A	A	O D	O1 O2 O3

Accesorios / Accessories



<b>1</b>	<b>3</b>	<b>5</b>	<b>8</b>
B61 <i>Fenix Acc.</i>	L <i>LED COB</i>	O6 5,84W	O ON-OFF D DALI
<b>2</b>	<b>4</b>	<b>6</b>	<b>9</b>
A <i>Codo 90°</i>	30 CRI80 2700K (950lm) 31 CRI80 3000K (980lm) 33 CRI80 4000K (1040lm) 39 CRI90 3000K (860lm) 40 CRI90 4000K (900lm)	A AC110-240V B AC220-240V	O1 <input type="checkbox"/> O2 <input checked="" type="checkbox"/> O3 <input checked="" type="checkbox"/>
		<b>7</b>	
		A 108°	

<b>1</b>	<b>2</b>	<b>3</b>	<b>4</b>	<b>5</b>	<b>6</b>	<b>7</b>	<b>8</b>	<b>9</b>
B61	A	L	30 31 33 39 40	O6	A B	A	O D	O1 O2 O3

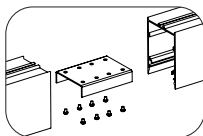

Unión línea continua / Continuous line connection

A58E-1061-41

ACER



2	*	(A) 596mm	(B) 876mm	(C) 1156mm	(D) 1442mm	(E) 1722mm	(F) 2002mm	(G) 2282mm
		582x68mm	862x68mm	1142x68mm	1428x68mm	1708x68mm	1988x68mm	2268x68mm
5		(12) 11,65W	(18) 17,50W	(24) 23,30W	(30) 29,15W	(35) 34,95W	(41) 40,80W	(47) 46,60W
4	(30) CR80 2700K	1905lm	2855lm	3810lm	4760lm	5715lm	6665lm	7620lm
	(31) CR80 3000K	1960lm	2940lm	3920lm	4900lm	5880lm	6860lm	7840lm
	(33) CR80 4000K	2070lm	3105lm	4140lm	5175lm	6210lm	7245lm	8280lm
	(39) CR90 3000K	1670lm	2505lm	3340lm	4175lm	5010lm	5845lm	6680lm
	(40) CR90 4000K	1745lm	2620lm	3490lm	4365lm	5235lm	6110lm	6980lm



Acabado blanco, negro o gris / White, black or grey finish

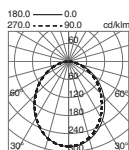

<p>Wall (Down)</p> <p>p. 106</p>	<p>Ceiling</p> <p>p. 108</p>	<p>Recessed Trimless</p> <p>p. 112</p>	<p>Pendant Dir</p> <p>p. 114</p>	<p>Pendant Dir/Indir.</p> <p>p. 116</p>
----------------------------------	------------------------------	--	----------------------------------	---

Campos / Fields

Acabados/Finishes

<b>1</b>	<b>2</b>	<b>3</b>	<b>4</b>	<b>5</b>	<b>6</b>	<b>7</b>	<b>8</b>	<b>9</b>
----------	----------	----------	----------	----------	----------	----------	----------	----------

<i>Familia</i> <i>Family</i>	<i>Modelo</i> <i>Model</i>	<i>Fuente de luz</i> <i>Lighting source</i>	<i>CRI / °K</i>	<i>Potencia (W)</i> <i>Power (W)</i>	<i>Voltaje</i> <i>Voltage</i>	<i>Óptica</i> <i>Light beam</i>	<i>Regulación</i> <i>Dimmable</i>	<i>Aro</i> <i>Ring</i>
---------------------------------	-------------------------------	--	-----------------	---	----------------------------------	------------------------------------	--------------------------------------	---------------------------

<b>1</b>	<b>3</b>	<b>5</b>	<b>6</b>	<b>8</b>
1065 <i>Fenix Recessed</i>	L <i>LED COB</i>	12 <i>11,65W</i> 18 <i>17,50W</i> 24 <i>23,30W</i> 30 <i>29,15W</i> 35 <i>34,95W</i> 41 <i>40,80W</i> 47 <i>46,60W</i>	A <i>AC110-240V</i>	O <i>ON-OFF</i> D <i>DALI</i>
<b>2</b>	<b>4</b>	<b>7</b>	<b>9</b>	
A <i>596mm</i> B <i>876mm</i> C <i>1156mm</i> D <i>1442mm</i> E <i>1722mm</i> F <i>2002mm</i> G <i>2282mm</i>	30 <i>CRI80 2700K</i> 31 <i>CRI80 3000K</i> 33 <i>CRI80 4000K</i> 39 <i>CRI90 3000K</i> 40 <i>CRI90 4000K</i>	A <i>108°</i>	O1 <input type="checkbox"/> O2 <input checked="" type="checkbox"/> O3 <input checked="" type="checkbox"/>	

<b>1</b>	<b>2</b>	<b>3</b>	<b>4</b>	<b>5</b>	<b>6</b>	<b>7</b>	<b>8</b>	<b>9</b>
1065	A	L	30 31 33 39 40	12	A	A	O D	O1 O2 O3
	B			18				
	C			24				
	D			30				
	E			35				
	F			41				
	G			47				

Accesorios / Accessories



<b>1</b>	<b>3</b>	<b>5</b>	<b>8</b>
B65 <i>Fenix Acc.</i>	L <i>LED COB</i>	O6 <i>5,84W</i>	O <i>ON-OFF</i> D <i>DALI</i>
<b>2</b>	<b>4</b>	<b>6</b>	<b>9</b>
A <i>Codo 90°</i>	30 <i>CRI80 2700K (950lm)</i> 31 <i>CRI80 3000K (980lm)</i> 33 <i>CRI80 4000K (1040lm)</i> 39 <i>CRI90 3000K (860lm)</i> 40 <i>CRI90 4000K (900lm)</i>	A <i>AC110-240V</i> B <i>AC220-240V</i>	O1 <input type="checkbox"/> O2 <input checked="" type="checkbox"/> O3 <input checked="" type="checkbox"/>
		<b>7</b>	
		A <i>108°</i>	

<b>1</b>	<b>2</b>	<b>3</b>	<b>4</b>	<b>5</b>	<b>6</b>	<b>7</b>	<b>8</b>	<b>9</b>
B65	A	L	30 31 33 39 40	O6	A	A	O D	O1 O2 O3
			B					

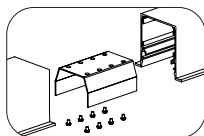

Unión línea continua / Continuous line connection

A58F-1065-41



 Recessed Trimless



Sistema Trimless / Trimless system

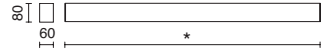
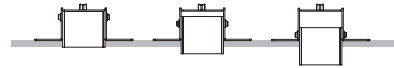



2	*	(A) 581mm	(B) 861mm	(C) 1141mm	(D) 1431mm	(E) 1711mm	(F) 1991mm	(G) 2271mm
		583x62mm	863x62mm	1143x62mm	1433x62mm	1713x62mm	1993x62mm	2273x62mm
5		(12) 11,65W	(18) 17,50W	(24) 23,30W	(30) 29,15W	(35) 34,95W	(41) 40,80W	(47) 46,60W
4	(30) CR80 2700K	1905lm	2855lm	3810lm	4760lm	5715lm	6665lm	7620lm
	(31) CR80 3000K	1960lm	2940lm	3920lm	4900lm	5880lm	6860lm	7840lm
	(33) CR80 4000K	2070lm	3105lm	4140lm	5175lm	6210lm	7245lm	8280lm
	(39) CR90 3000K	1670lm	2505lm	3340lm	4175lm	5010lm	5845lm	6680lm
	(40) CR90 4000K	1745lm	2620lm	3490lm	4365lm	5235lm	6110lm	6980lm

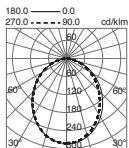

Acabado blanco, negro o gris / White, black or grey finish



 <p>Wall (Down) p. 106</p>	 <p>Ceiling p. 108</p>	 <p>Recessed p. 110</p>	 <p>Pendant Dir p. 114</p>	 <p>Pendant Dir/Indir. p. 116</p>
---	---	--	---	--



Campos / Fields

Acabados/Finishes

<b>1</b>	<b>2</b>	<b>3</b>	<b>4</b>	<b>5</b>	<b>6</b>	<b>7</b>	<b>8</b>	<b>9</b>
----------	----------	----------	----------	----------	----------	----------	----------	----------

<i>Familia</i> <i>Family</i>	<i>Modelo</i> <i>Model</i>	<i>Fuente de luz</i> <i>Lighting source</i>	<i>CRI / °K</i>	<i>Potencia (W)</i> <i>Power (W)</i>	<i>Voltaje</i> <i>Voltage</i>	<i>Óptica</i> <i>Light beam</i>	<i>Regulación</i> <i>Dimmable</i>	<i>Aro</i> <i>Ring</i>
---------------------------------	-------------------------------	--	-----------------	---	----------------------------------	------------------------------------	--------------------------------------	---------------------------

<b>1</b>	<b>3</b>	<b>5</b>	<b>6</b>	<b>8</b>
1063 <i>Fenix</i> <i>Recessed Trimless</i>	L <i>LED COB</i>	12 <i>11,65W</i> 18 <i>17,50W</i> 24 <i>23,30W</i> 30 <i>29,15W</i> 35 <i>34,95W</i> 41 <i>40,80W</i> 47 <i>46,60W</i>	A <i>AC110-240V</i>	O <i>ON-OFF</i> D <i>DALI</i>
<b>2</b>	<b>4</b>	<b>7</b>	<b>9</b>	
A <i>581mm</i> B <i>861mm</i> C <i>1141mm</i> D <i>1431mm</i> E <i>1711mm</i> F <i>1991mm</i> G <i>2271mm</i>	30 <i>CRI80 2700K</i> 31 <i>CRI80 3000K</i> 33 <i>CRI80 4000K</i> 39 <i>CRI90 3000K</i> 40 <i>CRI90 4000K</i>	A <i>108°</i>	O1 <input type="checkbox"/> O2 <input checked="" type="checkbox"/> O3 <input checked="" type="checkbox"/>	

<b>1</b>	<b>2</b>	<b>3</b>	<b>4</b>	<b>5</b>	<b>6</b>	<b>7</b>	<b>8</b>	<b>9</b>
1063	A B C D E F G	L	30 31 33 39 40	12 18 24 30 35 41 47	A	A	O D	O1 O2 O3

Accesorios / Accessories



<b>1</b>	<b>3</b>	<b>5</b>	<b>8</b>
B61 <i>Fenix Acc.</i>	L <i>LED COB</i>	O6 <i>5,84W</i>	O <i>ON-OFF</i> D <i>DALI</i>
<b>2</b>	<b>4</b>	<b>6</b>	<b>9</b>
A <i>Codo 90°</i>	30 <i>CRI80 2700K (950lm)</i> 31 <i>CRI80 3000K (980lm)</i> 33 <i>CRI80 4000K (1040lm)</i> 39 <i>CRI90 3000K (860lm)</i> 40 <i>CRI90 4000K (900lm)</i>	A <i>AC110-240V</i> B <i>AC220-240V</i>	O1 <input type="checkbox"/> O2 <input checked="" type="checkbox"/> O3 <input checked="" type="checkbox"/>
		<b>7</b>	
		A <i>108°</i>	

<b>1</b>	<b>2</b>	<b>3</b>	<b>4</b>	<b>5</b>	<b>6</b>	<b>7</b>	<b>8</b>	<b>9</b>
B61	A	L	30 31 33 39 40	O6	A B	A	O D	O1 O2 O3

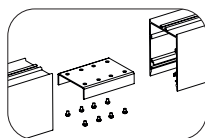

Unión línea continua / Continuous line connection

A58E-1061-41

ACER

 *Pendant Dir.*

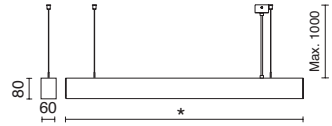



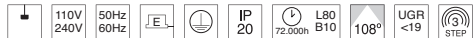

2	*	(A) 581mm	(B) 861mm	(C) 1141mm	(D) 1431mm	(E) 1711mm	(F) 1991mm	(G) 2271mm
5		(12) 11.65W	(18) 17.50W	(24) 23.30W	(30) 29.15W	(35) 34.95W	(41) 40.80W	(47) 46.60W
4	(30) CR80 2700K	1905lm	2855lm	3810lm	4760lm	5715lm	6665lm	7620lm
	(31) CR80 3000K	1960lm	2940lm	3920lm	4900lm	5880lm	6860lm	7840lm
	(33) CR80 4000K	2070lm	3105lm	4140lm	5175lm	6210lm	7245lm	8280lm
	(39) CR90 3000K	1670lm	2505lm	3340lm	4175lm	5010lm	5845lm	6680lm
	(40) CR90 4000K	1745lm	2620lm	3490lm	4365lm	5235lm	6110lm	6980lm

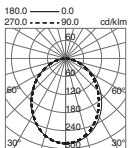

Acabado blanco, negro o gris / White, black or grey finish



<i>Wall (Down)</i>  p. 106	<i>Ceiling</i>  p. 108	<i>Recessed</i>  p. 110	<i>Recessed Trimless</i>  p. 112	<i>Pendant Dir./Indir.</i>  p. 116
---	---	--	---	---

Campos / Fields

Acabados/Finishes

<b>1</b>	<b>2</b>	<b>3</b>	<b>4</b>	<b>5</b>	<b>6</b>	<b>7</b>	<b>8</b>	<b>9</b>
----------	----------	----------	----------	----------	----------	----------	----------	----------

<i>Familia</i> <i>Family</i>	<i>Modelo</i> <i>Model</i>	<i>Fuente de luz</i> <i>Lighting source</i>	<i>CRI / °K</i>	<i>Potencia (W)</i> <i>Power (W)</i>	<i>Voltaje</i> <i>Voltage</i>	<i>Óptica</i> <i>Light beam</i>	<i>Regulación</i> <i>Dimmable</i>	<i>Aro</i> <i>Ring</i>
---------------------------------	-------------------------------	--	-----------------	---	----------------------------------	------------------------------------	--------------------------------------	---------------------------

<b>1</b>	<b>3</b>	<b>5</b>	<b>6</b>	<b>8</b>
1061 <i>Fenix</i> <i>Pendant Dir</i>	L <i>LED COB</i>	12 11,65W 18 17,50W 24 23,30W 30 29,15W 35 34,95W 41 40,80W 47 46,60W	A AC110-240V	O ON-OFF D DALI
<b>2</b>	<b>4</b>	<b>7</b>	<b>9</b>	
A 581mm B 861mm C 1141mm D 1431mm E 1711mm F 1991mm G 2271mm	30 CRI80 2700K 31 CRI80 3000K 33 CRI80 4000K 39 CRI90 3000K 40 CRI90 4000K	A 108°	O1 <input type="checkbox"/> O2 <input checked="" type="checkbox"/> O3 <input checked="" type="checkbox"/>	

<b>1</b>	<b>2</b>	<b>3</b>	<b>4</b>	<b>5</b>	<b>6</b>	<b>7</b>	<b>8</b>	<b>9</b>
1061	A B C D E F G	L	30 31 33 39 40	12 18 24 30 35 41 47	A	A	O D	O1 O2 O3

Accesorios / Accessories



<b>1</b>	<b>3</b>	<b>5</b>	<b>8</b>
B61 <i>Fenix Acc.</i>	L <i>LED COB</i>	O6 5,84W	O ON-OFF D DALI
<b>2</b>	<b>4</b>	<b>6</b>	<b>9</b>
A <i>Codo 90°</i>	30 CRI80 2700K (950lm) 31 CRI80 3000K (980lm) 33 CRI80 4000K (1040lm) 39 CRI90 3000K (860lm) 40 CRI90 4000K (900lm)	A AC110-240V B AC220-240V	O1 <input type="checkbox"/> O2 <input checked="" type="checkbox"/> O3 <input checked="" type="checkbox"/>
		<b>7</b>	
		A 108°	

<b>1</b>	<b>2</b>	<b>3</b>	<b>4</b>	<b>5</b>	<b>6</b>	<b>7</b>	<b>8</b>	<b>9</b>
B61	A	L	30 31 33 39 40	O6	A B	A	O D	O1 O2 O3

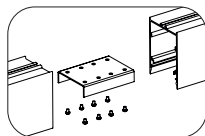

Unión línea continua / Continuous line connection

A58E-1061-41



 Pendant Dir./Indir.

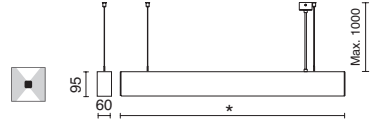
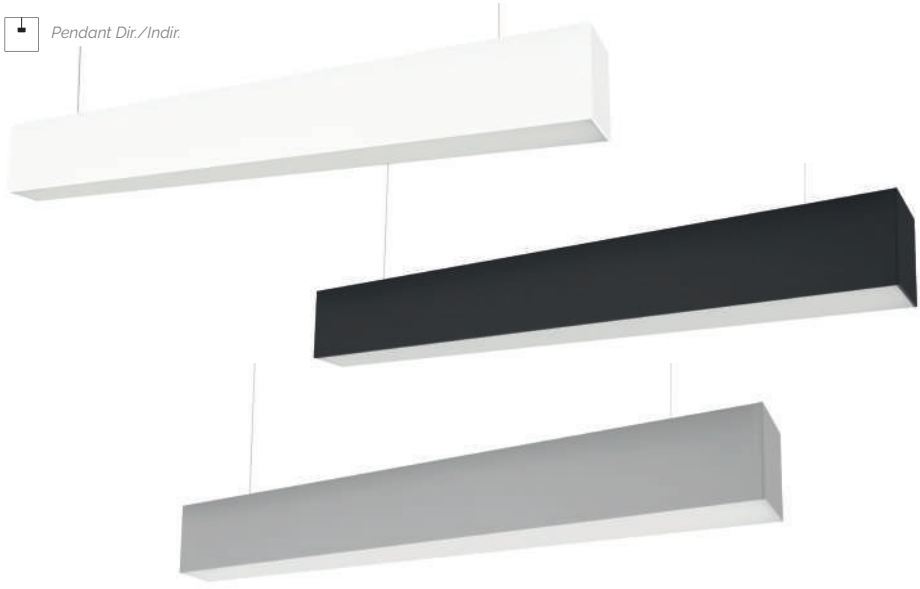







2	*	(A) 591mm	(B) 871mm	(C) 1157mm	(D) 1437mm	(E) 1717mm	(F) 1979mm	(G) 2259mm
5		(23) 23.3W	(35) 35W	(47) 46.6W	(58) 58.3W	(70) 70W	(82) 81.6W	(93) 93.3W
4	(30) CR80 2700K	3810lm	5710lm	7620lm	9520lm	11430lm	13330lm	15240lm
	(31) CR80 3000K	3920lm	5880lm	7840lm	9800lm	11760lm	13720lm	15680lm
	(33) CR80 4000K	4140lm	6210lm	8280lm	10350lm	12420lm	14490lm	16560lm
	(39) CR90 3000K	3340lm	5010lm	6680lm	8350lm	10020lm	11690lm	13360lm
	(40) CR90 4000K	3490lm	5240lm	6980lm	8730lm	10470lm	12220lm	13960lm

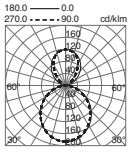

Acabado blanco, negro o gris / White, black or grey finish

Incluye 2 grapas para la suspensión  
Includes 2 clips for suspension



Wall (Down)	Ceiling	Recessed	Recessed Trimless	Pendant Dir
 p. 106	 p. 108	 p. 110	 p. 112	 p. 114

Campos / Fields

Acabados/Finishes

1	2	3	4	5	6	7	8	9
Familia Family	Modelo Model	Fuente de luz Lighting source	CRI / °K	Potencia (W) Power (W)	Voltaje Voltage	Óptica Light beam	Regulación Dimmable	Aro Ring
<b>1</b>	<b>3</b>	<b>5</b>	<b>6</b>	<b>8</b>				
1064 Fenix Pendant Dir./Indir.	L LED COB	23 23,3W 35 35W 47 46,6W 58 58,3W 70 70W 82 81,6W 93 93,3W	A AC110-240V	O ON-OFF D DALI				
<b>2</b>	<b>4</b>	<b>7</b>	<b>9</b>					
A 591mm B 871mm C 1157mm D 1437mm E 1717mm F 1979mm G 2259mm	30 CRI80 2700K 31 CRI80 3000K 33 CRI80 4000K 39 CRI90 3000K 40 CRI90 4000K	A 108°	O1 <input type="checkbox"/> O2 <input checked="" type="checkbox"/> O3 <input checked="" type="checkbox"/>					

1	2	3	4	5	6	7	8	9
1064	A	L	30 31 33 39 40	12	A	A	O D	O1 O2 O3
	B			18				
	C			24				
	D			30				
	E			35				
	F			41				
	G			47				

Accesorios / Accessories



1	2	3	4	5	6	7	8	9
<b>1</b>	<b>3</b>	<b>5</b>	<b>8</b>					
B64 Fenix Acc.	L LED COB	06 5,84W	O ON-OFF D DALI					
<b>2</b>	<b>4</b>	<b>6</b>	<b>9</b>					
A Codo 90°	30 CRI80 2700K (950lm) 31 CRI80 3000K (980lm) 33 CRI80 4000K (1040lm) 39 CRI90 3000K (860lm) 40 CRI90 4000K (900lm)	A AC110-240V B AC220-240V	O1 <input type="checkbox"/> O2 <input checked="" type="checkbox"/> O3 <input checked="" type="checkbox"/>					
		<b>7</b>						
		A 108°						

1	2	3	4	5	6	7	8	9
B64	A	L	30 31 33 39 40	06	A B	A	O D	O1 O2 O3



Unión línea continua / Continuous line connection

A58C-808-41

ACER



**CRI >90**  
**2700K**  
 LED SMD 6W 649lm

- 809C-L3806B-01
- 809C-L3806B-03

- 809C-L3806B4M-01
- 809C-L3806B4M-03

**CRI >80**  
**3000K**  
 LED SMD 6W 547lm

- 809C-L3106B-01
- 809C-L3106B-03

- 809C-L3106B4M-01
- 809C-L3106B4M-03

**CRI >80**  
**4000K**  
 LED SMD 6W 637lm

- 809C-L3306B-01
- 809C-L3306B-03

- 809C-L3306B4M-01
- 809C-L3306B4M-03

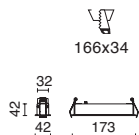

CASAMBI

**CRI >90**  
**2700K**  
 LED SMD 11W 1298lm

- 809D-L3813B-01
- 809D-L3813B-03

- 809D-L3813B4M-01
- 809D-L3813B4M-03

**CRI >80**  
**3000K**  
 LED SMD 11W 1185lm

- 809D-L3113B-01
- 809D-L3113B-03

- 809D-L3113B4M-01
- 809D-L3113B4M-03

**CRI >80**  
**4000K**  
 LED SMD 11W 1380lm

- 809D-L3313B-01
- 809D-L3313B-03

- 809D-L3313B4M-01
- 809D-L3313B4M-03

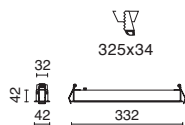

CASAMBI

**CRI >90**  
**2700K**  
 LED SMD 25W 2596lm

- 809E-L3825B-01
- 809E-L3825B-03

- 809E-L38RDB-01
- 809E-L38RDB-03

- 809E-L3825B4M-01
- 809E-L3825B4M-03

**CRI >80**  
**3000K**  
 LED SMD 25W 2280lm

- 809E-L3125B-01
- 809E-L3125B-03

- 809E-L31RDB-01
- 809E-L31RDB-03

- 809E-L3125B4M-01
- 809E-L3125B4M-03

**CRI >80**  
**4000K**  
 LED SMD 25W 2655lm

- 809E-L3325B-01
- 809E-L3325B-03

- 809E-L33RDB-01
- 809E-L33RDB-03

- 809E-L3325B4M-01
- 809E-L3325B4M-03

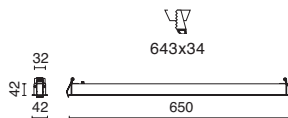

CASAMBI



Acabado blanco o gris / White or grey finish

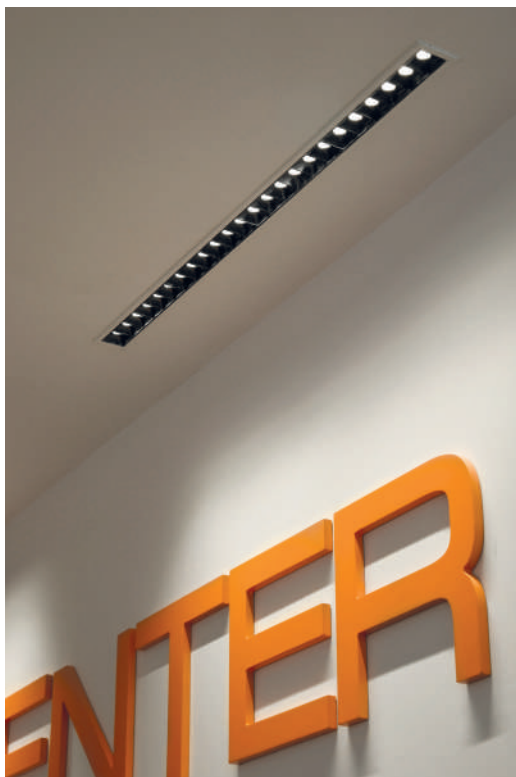

Mobilcenter (Marresa)

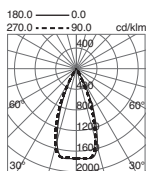

**809C-L3806B**

h (m)	d (m)	E (lux)
1,00	0,89	1137
2,00	1,78	284
3,00	2,67	126
4,00	3,56	71
5,00	4,45	45

**809C-L3106B**

h (m)	d (m)	E (lux)
1,00	0,89	958
2,00	1,78	240
3,00	2,67	106
4,00	3,56	60
5,00	4,45	38

**809C-L3306B**

h (m)	d (m)	E (lux)
1,00	0,89	1115
2,00	1,78	279
3,00	2,67	124
4,00	3,56	70
5,00	4,45	45

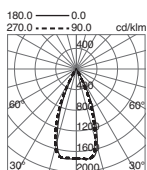

**809D-L3813B**

h (m)	d (m)	E (lux)
1,00	0,89	2273
2,00	1,78	568
3,00	2,67	252
4,00	3,56	142
5,00	4,45	91

**809D-L3113B**

h (m)	d (m)	E (lux)
1,00	0,89	2075
2,00	1,78	519
3,00	2,67	231
4,00	3,56	130
5,00	4,45	83

**809D-L3313B**

h (m)	d (m)	E (lux)
1,00	0,89	2416
2,00	1,78	604
3,00	2,67	268
4,00	3,56	151
5,00	4,45	97

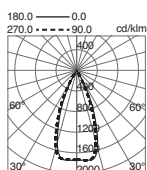

**809E-L3825B**



h (m)	d (m)	E (lux)
1,00	0,89	4545
2,00	1,78	1136
3,00	2,67	505
4,00	3,56	284
5,00	4,45	181

**809E-L3125B**

h (m)	d (m)	E (lux)
1,00	0,89	3992
2,00	1,78	998
3,00	2,67	444
4,00	3,56	250
5,00	4,45	160

**809E-L3325B**

h (m)	d (m)	E (lux)
1,00	0,89	4648
2,00	1,78	1162
3,00	2,67	516
4,00	3,56	291
5,00	4,45	186

<p>Recessed Trimless</p>  <p>p. 120</p>	<p>Pendant</p>  <p>p. 122</p>
--	--



**CRI >90**  
**2700K**  
 LED SMD 6W 649lm

- 809F-L3806B-01
- 809F-L3806B-03

- 809F-L3806B4M-01
- 809F-L3806B4M-03

**CRI >80**  
**3000K**  
 LED SMD 6W 547lm

- 809F-L3106B-01
- 809F-L3106B-03

- 809F-L3106B4M-01
- 809F-L3106B4M-03

**CRI >80**  
**4000K**  
 LED SMD 6W 637lm

- 809F-L3306B-01
- 809F-L3306B-03

- 809F-L3306B4M-01
- 809F-L3306B4M-03



CASAMBI



**CRI >90**  
**2700K**  
 LED SMD 11W 1298lm

- 809G-L3813B-01
- 809G-L3813B-03

- 809G-L3813B4M-01
- 809G-L3813B4M-03

**CRI >80**  
**3000K**  
 LED SMD 11W 1185lm

- 809G-L3113B-01
- 809G-L3113B-03

- 809G-L3113B4M-01
- 809G-L3113B4M-03

**CRI >80**  
**4000K**  
 LED SMD 11W 1380lm

- 809G-L3313B-01
- 809G-L3313B-03

- 809G-L3313B4M-01
- 809G-L3313B4M-03

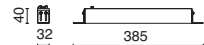

CASAMBI



**CRI >90**  
**2700K**  
 LED SMD 25W 2596lm

- 809H-L3825B-01
- 809H-L3825B-03

- 809H-L38RDB-01
- 809H-L38RDB-03

- 809H-L3825B4M-01
- 809H-L3825B4M-03

**CRI >80**  
**3000K**  
 LED SMD 25W 2280lm

- 809H-L3125B-01
- 809H-L3125B-03

- 809H-L31RDB-01
- 809H-L31RDB-03

- 809H-L3125B4M-01
- 809H-L3125B4M-03

**CRI >80**  
**4000K**  
 LED SMD 25W 2655lm

- 809H-L3325B-01
- 809H-L3325B-03

- 809H-L33RDB-01
- 809H-L33RDB-03

- 809H-L3325B4M-01
- 809H-L3325B4M-03

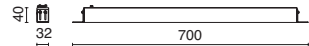

CASAMBI



Acabado blanco o gris / White or grey finish

Con Driver remoto  
 With Remote Driver





Sistema Trimless / Trimless system

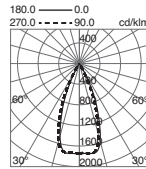

**809F-L3806B**

h (m)	d (m)	E (lux)
1,00	0,89	1137
2,00	1,78	284
3,00	2,67	126
4,00	3,56	71
5,00	4,45	45

**809F-L3106B**

h (m)	d (m)	E (lux)
1,00	0,89	958
2,00	1,78	240
3,00	2,67	106
4,00	3,56	60
5,00	4,45	38

**809F-L3306B**

h (m)	d (m)	E (lux)
1,00	0,89	1115
2,00	1,78	279
3,00	2,67	124
4,00	3,56	70
5,00	4,45	45

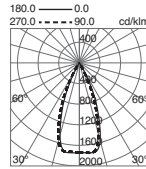

**809G-L3813B**

h (m)	d (m)	E (lux)
1,00	0,89	2273
2,00	1,78	568
3,00	2,67	252
4,00	3,56	142
5,00	4,45	91

**809G-L3113B**

h (m)	d (m)	E (lux)
1,00	0,89	2075
2,00	1,78	519
3,00	2,67	231
4,00	3,56	130
5,00	4,45	83

**809G-L3313B**

h (m)	d (m)	E (lux)
1,00	0,89	2416
2,00	1,78	604
3,00	2,67	268
4,00	3,56	151
5,00	4,45	97

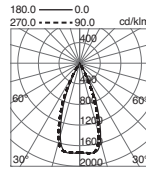

**809H-L3825B**

h (m)	d (m)	E (lux)
1,00	0,89	4545
2,00	1,78	1136
3,00	2,67	505
4,00	3,56	284
5,00	4,45	181

**809H-L3125B**

h (m)	d (m)	E (lux)
1,00	0,89	3992
2,00	1,78	998
3,00	2,67	444
4,00	3,56	250
5,00	4,45	160

**809H-L3325B**

h (m)	d (m)	E (lux)
1,00	0,89	4648
2,00	1,78	1162
3,00	2,67	516
4,00	3,56	291
5,00	4,45	186

<p>Recessed with frame</p> <p>p. 118</p>	<p>Pendant</p> <p>p. 122</p>
--	------------------------------

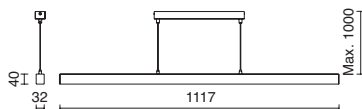

**CRI >90**  
**2700K**  
 LED SMD 44W 4543lm

- 809A-L3844B-01
- 809A-L3844B-03

- 809A-L38RDB-01
- 809A-L38RDB-03

**CRI >80**  
**3000K**  
 LED SMD 44W 4010lm

- 809A-L3144B-01
- 809A-L3144B-03

- 809A-L31RDB-01
- 809A-L31RDB-03

**CRI >80**  
**4000K**  
 LED SMD 44W 4670lm

- 809A-L3344B-01
- 809A-L3344B-03

- 809A-L33RDB-01
- 809A-L33RDB-03

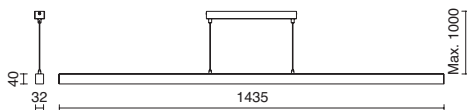

**CRI >90**  
**2700K**  
 LED SMD 57W 5840lm

- 809B-L3857B-01
- 809B-L3857B-03

- 809B-L38RDB-01
- 809B-L38RDB-03

**CRI >80**  
**3000K**  
 LED SMD 25W 2280lm

- 809B-L3157B-01
- 809B-L3157B-03

- 809B-L31RDB-01
- 809B-L31RDB-03

**CRI >80**  
**4000K**  
 LED SMD 57W 6050lm

- 809B-L3357B-01
- 809B-L3357B-03

- 809B-L33RDB-01
- 809B-L33RDB-03



Acabado blanco o gris / White or grey finish

Con Driver remoto  
 With Remote Driver

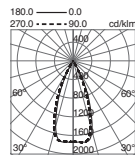

**809A-L3844B**

h (m)	d (m)	E (lux)
1,00	0,89	7954
2,00	1,78	1988
3,00	2,67	884
4,00	3,56	497
5,00	4,45	318

**809A-L3144B**

h (m)	d (m)	E (lux)
1,00	0,89	7021
2,00	1,78	1755
3,00	2,67	780
4,00	3,56	430
5,00	4,45	281

**809A-L3344B**

h (m)	d (m)	E (lux)
1,00	0,89	8176
2,00	1,78	2044
3,00	2,67	908
4,00	3,56	511
5,00	4,45	327

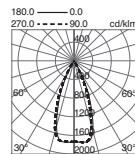

**809B-L3857B**



h (m)	d (m)	E (lux)
1,00	0,89	10225
2,00	1,78	2556
3,00	2,67	1136
4,00	3,56	639
5,00	4,45	409

**809B-L3157B**

h (m)	d (m)	E (lux)
1,00	0,89	9096
2,00	1,78	2274
3,00	2,67	1011
4,00	3,56	569
5,00	4,45	364

**809B-L3357B**

h (m)	d (m)	E (lux)
1,00	0,89	10592
2,00	1,78	2648
3,00	2,67	1177
4,00	3,56	662
5,00	4,45	424

<p>Recessed Trimless</p>  <p>p. 118</p>	<p>Recessed with frame</p>  <p>p. 120</p>
--	--



# Spotlights



	UKU 1	UKU 2	UKU 3	UKU 4	UKU 5	UKU 6
	1055	1056	1057	1058	1059	1060
A						
B						
C						
D						
	p.128	p.130	p.132	p.134	p.136	p.138



SPOTLIGHTS



W  
SELECT 6W / 9W

K  
SELECT 2700K / 3000K / 4000K



45°  
0° / 15° / 30° / 45°

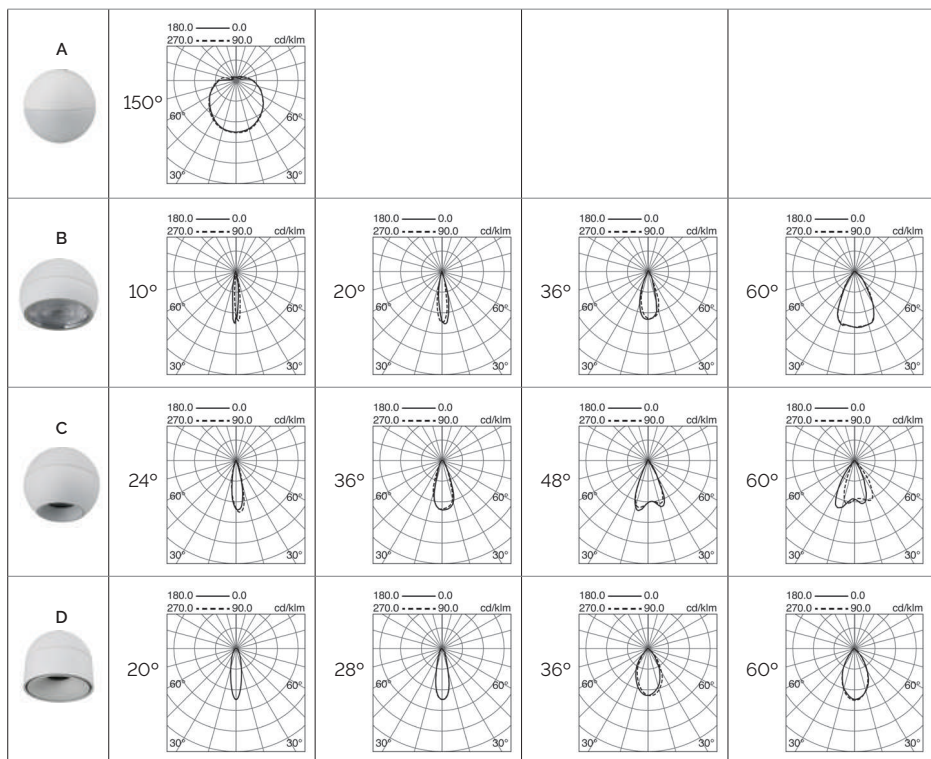



Empotrable techo / Recessed ceiling



ALU



220V  
240V

50Hz  
60Hz



JEL

IP  
20

50.000h

L80  
B20

CRI  
>90



W  
SELECT

K  
SELECT

45°

Acabado blanco o negro / White or black finish



Campos / Fields

Acabados/Finishes

<b>1</b>	<b>2</b>	<b>3</b>	<b>4</b>	<b>5</b>	<b>6</b>	<b>7</b>	<b>8</b>	<b>9</b>	<b>10</b>
----------	----------	----------	----------	----------	----------	----------	----------	----------	-----------

<i>Familia</i> Family	<i>Modelo</i> Model	<i>Fuente de luz</i> Lighting source	<i>CRI / °K</i>	<i>Potencia (W)</i> Power (W)	<i>Voltaje</i> Voltage	<i>Óptica</i> Light beam	<i>Regulación</i> Dimmable	<i>Cuerpo</i> Body	<i>Embelledor</i> Baffle
--------------------------	------------------------	---	-----------------	----------------------------------	---------------------------	-----------------------------	-------------------------------	-----------------------	-----------------------------

**1**  
1055 UKU 1

**3**  
L LED COB

**6**  
B AC220-240V

**8**  
0 ON-OFF

**2**

A Opal half
B Short round half
C Long round half
D Cylindrical half

**4**  
41 CRI90  
(2700K/3000K/4000K)

**5**  
MP 6W/9W

<b>7</b>	1055A-	1055B-	1055C-	1055D-
F	150°			
1		10°		20°
2		20°	24°	28°
3		36°	36°	36°
4			48°	
6		60°	60°	60°

**9**

01 <input type="checkbox"/>
02 <input checked="" type="checkbox"/>

**10**

01 <input type="checkbox"/>
02 <input checked="" type="checkbox"/>
47 <input checked="" type="checkbox"/>

1	2	3	4	5	6	7	8	9	10
1055	A	L	41	MP	B	F	O	01 02	01 02 47
	B					1 2 3 6			
	C					2 3 4 6			
	D					1 2 3 6			



Proyector carril / Track spotlight



ALU

Acabado blanco o negro / White or black finish

Campos / Fields

Acabados/Finishes

<b>1</b>	<b>2</b>	<b>3</b>	<b>4</b>	<b>5</b>	<b>6</b>	<b>7</b>	<b>8</b>	<b>9</b>	<b>10</b>
----------	----------	----------	----------	----------	----------	----------	----------	----------	-----------

Familia Family	Modelo Model	Fuente de luz Lighting source	CRI / °K	Potencia (W) Power (W)	Voltaje Voltage	Óptica Light beam	Regulación Dimmable	Cuerpo Body	Embellecedor Baffle
-------------------	-----------------	----------------------------------	----------	---------------------------	--------------------	----------------------	------------------------	----------------	------------------------

**1**  
1056 UKU 2

**3**  
L LED COB

**6**  
B AC220-240V

**8**  
0 ON-OFF

**2**

A	Opal half
B	Short round half
C	Long round half
D	Cylindrical half

**4**

41	CRI90 (2700K/3000K/4000K)
----	------------------------------

**5**

MP	6W/9W
----	-------

**7** 1056A- 1056B- 1056C- 1056D-

F	150°		
1	10°	20°	
2	20°	24°	28°
3	36°	36°	36°
4	48°		
6	60°	60°	60°

**9**

01	<input type="checkbox"/>
02	<input checked="" type="checkbox"/>

**10**

01	<input type="checkbox"/>
02	<input checked="" type="checkbox"/>
47	<input checked="" type="checkbox"/>

<b>1</b>	<b>2</b>	<b>3</b>	<b>4</b>	<b>5</b>	<b>6</b>	<b>7</b>	<b>8</b>	<b>9</b>	<b>10</b>
1056	A	L	41	MP	B	F	O	01 02	01 02 47
	B					1 2 3 6			
	C					2 3 4 6			
	D					1 2 3 6			



Carril / Track p. 254-257



Aplique pared / Wall-mounted



Acabado blanco o negro / White or black finish

Campos / Fields

Acabados/Finishes

<b>1</b>	<b>2</b>	<b>3</b>	<b>4</b>	<b>5</b>	<b>6</b>	<b>7</b>	<b>8</b>	<b>9</b>	<b>10</b>
----------	----------	----------	----------	----------	----------	----------	----------	----------	-----------

Familia Family	Modelo Model	Fuente de luz Lighting source	CRI / °K	Potencia (W) Power (W)	Voltaje Voltage	Óptica Light beam	Regulación Dimmable	Cuerpo Body	Embelledor Baffle
-------------------	-----------------	----------------------------------	----------	---------------------------	--------------------	----------------------	------------------------	----------------	----------------------

**1**  
1057 UKU 3

**3**  
L LED COB

**6**  
B AC220-240V

**8**  
0 ON-OFF

**2**

A	Opal half
B	Short round half
C	Long round half
D	Cylindrical half

**4**

41	CRI90 (2700K/3000K/4000K)
----	------------------------------

**5**

MP	6W/9W
----	-------

**7** 1057A- 1057B- 1057C- 1057D-

F	150°		
1	10°	20°	
2	20°	24°	28°
3	36°	36°	36°
4	48°		
6	60°	60°	60°

**9**

01	<input type="checkbox"/>
02	<input checked="" type="checkbox"/>

**10**

01	<input type="checkbox"/>
02	<input checked="" type="checkbox"/>
47	<input checked="" type="checkbox"/>

<b>1</b>	<b>2</b>	<b>3</b>	<b>4</b>	<b>5</b>	<b>6</b>	<b>7</b>	<b>8</b>	<b>9</b>	<b>10</b>
1057	A	L	41	MP	B	F	O	01 02	01 02 47
	B					1 2 3 6			
	C					2 3 4 6			
	D					1 2 3 6			



Superficie techo / Ceiling surface

1058A-	1058B-	1058C-	1058D-

Acabado blanco o negro / White or black finish

Campos / Fields

Acabados/Finishes

<b>1</b>	<b>2</b>	<b>3</b>	<b>4</b>	<b>5</b>	<b>6</b>	<b>7</b>	<b>8</b>	<b>9</b>	<b>10</b>
----------	----------	----------	----------	----------	----------	----------	----------	----------	-----------

Familia Family	Modelo Model	Fuente de luz Lighting source	CRI / °K	Potencia (W) Power (W)	Voltaje Voltage	Óptica Light beam	Regulación Dimmable	Cuerpo Body	Embelecedor Baffle
-------------------	-----------------	----------------------------------	----------	---------------------------	--------------------	----------------------	------------------------	----------------	-----------------------

**1**  
1058 UKU 4

**3**  
L LED COB

**6**  
B AC220-240V

**8**  
0 ON-OFF

**2**

A	Opal half
B	Short round half
C	Long round half
D	Cylindrical half

**4**  
41 CRI90  
(2700K/3000K/4000K)

**5**  
MP 6W/9W

<b>7</b>	1058A-	1058B-	1058C-	1058D-
F	150°			
1		10°		20°
2		20°	24°	28°
3		36°	36°	36°
4			48°	
6		60°	60°	60°

**9**

01	<input type="checkbox"/>
02	<input checked="" type="checkbox"/>

**10**

01	<input type="checkbox"/>
02	<input checked="" type="checkbox"/>
47	<input checked="" type="checkbox"/>

<b>1</b>	<b>2</b>	<b>3</b>	<b>4</b>	<b>5</b>	<b>6</b>	<b>7</b>	<b>8</b>	<b>9</b>	<b>10</b>
1058	A	L	41	MP	B	F	O	01 02	01 02 47
	B					1 2 3 6			
	C					2 3 4 6			
	D					1 2 3 6			



Suspensión / Pendant



ALU

220V 240V
50Hz 60Hz

IP 20

L80 B20
CRI >90

W SELECT
K SELECT
45°

Acabado blanco o negro / White or black finish



Campos / Fields

Acabados/Finishes

<b>1</b>	<b>2</b>	<b>3</b>	<b>4</b>	<b>5</b>	<b>6</b>	<b>7</b>	<b>8</b>	<b>9</b>	<b>10</b>
----------	----------	----------	----------	----------	----------	----------	----------	----------	-----------

Familia Family	Modelo Model	Fuente de luz Lighting source	CRI / °K	Potencia (W) Power (W)	Voltaje Voltage	Óptica Light beam	Regulación Dimmable	Cuerpo Body	Embelecedor Baffle
-------------------	-----------------	----------------------------------	----------	---------------------------	--------------------	----------------------	------------------------	----------------	-----------------------

**1**  
1059 UKU 5

**3**  
L LED COB

**6**  
B AC220-240V

**8**  
0 ON-OFF

**2**  
A Opal half  
B Short round half  
C Long round half  
D Cylindrical half

**4**  
41 CRI90  
(2700K/3000K/4000K)  
**5**  
MP 6W/9W

<b>7</b>	1059A-	1059B-	1059C-	1059D-
F	150°			
1	10°		20°	
2	20°	24°	28°	
3	36°	36°	36°	
4		48°		
6	60°	60°	60°	

**9**  
01   
02   
**10**  
01   
02   
47

<b>1</b>	<b>2</b>	<b>3</b>	<b>4</b>	<b>5</b>	<b>6</b>	<b>7</b>	<b>8</b>	<b>9</b>	<b>10</b>
1059	A	L	41	MP	B	F	O	01 02	01 02 47
	B					1 2 3 6			
	C					2 3 4 6			
	D					1 2 3 6			





Suspensión carril / Track pendant

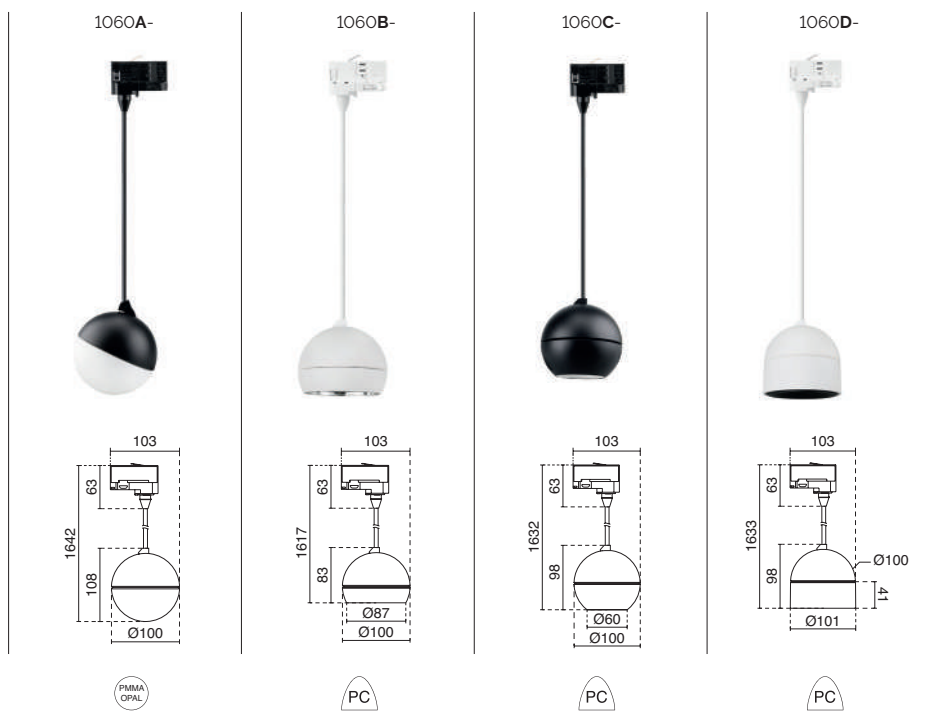

ALU



Acabado blanco o negro / White or black finish

Campos / Fields

Acabados/Finishes

<b>1</b>	<b>2</b>	<b>3</b>	<b>4</b>	<b>5</b>	<b>6</b>	<b>7</b>	<b>8</b>	<b>9</b>	<b>10</b>
----------	----------	----------	----------	----------	----------	----------	----------	----------	-----------

Familia Family	Modelo Model	Fuente de luz Lighting source	CRI / °K	Potencia (W) Power (W)	Voltaje Voltage	Óptica Light beam	Regulación Dimmable	Cuerpo Body	Embelledor Baffle
-------------------	-----------------	----------------------------------	----------	---------------------------	--------------------	----------------------	------------------------	----------------	----------------------

**1**  
1060 UKU 6

**3**  
L LED COB

**6**  
B AC220-240V

**8**  
0 ON-OFF

**2**

A	Opal half
B	Short round half
C	Long round half
D	Cylindrical half

**4**  
41 CRI90  
(2700K/3000K/4000K)

**5**  
MP 6W/9W

**7** 1060A- 1060B- 1060C- 1060D-

F	150°		
1	10°	20°	
2	20°	24°	28°
3	36°	36°	36°
4		48°	
6	60°	60°	60°

**9**

01	<input type="checkbox"/>
02	<input checked="" type="checkbox"/>

**10**

01	<input type="checkbox"/>
02	<input checked="" type="checkbox"/>
47	<input checked="" type="checkbox"/>

<b>1</b>	<b>2</b>	<b>3</b>	<b>4</b>	<b>5</b>	<b>6</b>	<b>7</b>	<b>8</b>	<b>9</b>	<b>10</b>
1060	A	L	41	MP	B	F	O	01 02	01 02 47
	B					1 2 3 6			
	C					2 3 4 6			
	D					1 2 3 6			



Carril / Track p. 254-257

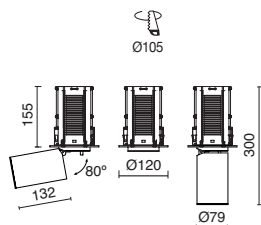

8,8W		18,6W	
2700K	1121lm	2700K	2157lm
3000K	1168lm	3000K	2342lm
4000K	1274lm	4000K	2449lm
FASHION	1380lm	FASHION	2389lm





-01-01

-01-32



### Filtros / Filters

	Antideslumbrante / Anti-glare ■ A04P-1002-02
	Prismatic / Prismatic ■ A47F-1002-92 

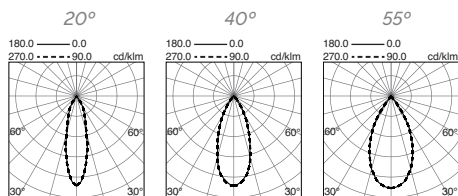

Acabado blanco con embellecedor blanco o cromado  
White finish with white or chrome baffle

Con Driver remoto  
With Remote Driver

Campos / Fields

Acabados/Finishes

<b>1</b>	<b>2</b>	<b>3</b>	<b>4</b>	<b>5</b>	<b>6</b>	<b>7</b>	<b>8</b>	<b>9</b>	<b>10</b>
----------	----------	----------	----------	----------	----------	----------	----------	----------	-----------

Familia Family	Modelo Model	Fuente de luz Lighting source	CRI / °K	Potencia (W) Power (W)	Voltaje Voltage	Óptica Light beam	Regulación Dimmable	Aro Ring	Embellecedor Baffle
-------------------	-----------------	----------------------------------	----------	---------------------------	--------------------	----------------------	------------------------	-------------	------------------------

<b>1</b>	<b>4</b>	<b>5</b>	<b>7</b>	<b>9</b>
1002 TURT	38 CRI90 2700K 39 CRI90 3000K 40 CRI90 4000K 51 CRI95 3250K (FASHION)	10 8,8W 20 18,6W	2 20° 4 40° 5 55°	01 <input type="checkbox"/>
<b>2</b>		<b>6</b>	<b>8</b>	<b>10</b>
A Medium		A AC110-240V B AC220-240V	O ON-OFF F LC (Trailing and leading edge) 1 PUSH/1-10V D DALI M CASAMBI	01 <input type="checkbox"/> 32 <input checked="" type="checkbox"/>
<b>3</b>				
L LED COB				

1	2	3	4	5	6	7	8	9	10
1002	A	L	38 39 40	10	B		O	01	01 32
					B	2	F		
					A	4	D		
					A	5	1		
					B		M		
					B		O		
			B	2	F				
			A	4	D				
			A	5	1				
			B		M				
			B		O				
			B	2	F				
		A	4	D					
		A	5	1					
		B		M					
		B		O					
		B	2	F					
		A	4	D					
		A	5	1					
		B		M					



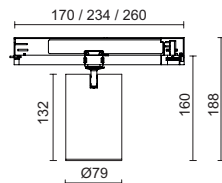

• Carril no incluido.  
• Track not included.

1003A-



8,8W		18,6W	
2700K	1121lm	2700K	2157lm
3000K	1168lm	3000K	2342lm
4000K	1274lm	4000K	2449lm
3250K <i>FASHION</i>	1380lm	3250K <i>FASHION</i>	2389lm

### Filtros / Filters

	Antideslumbrante / Anti-glare ■ A04P-1002-02	
	Prismatico / Prismatic ■ A47F-1002-92	



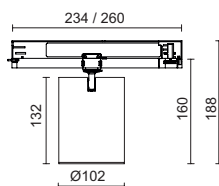

• Carril no incluido.  
• Track not included.

1003B-



24W		27,4W	
2000K <i>MEAT</i>	2349lm	2700K	3140lm
2500K <i>BREAD</i>	3169lm	3000K	3254lm
4000K <i>FISH</i>	3402lm	4000K	3570lm
3000K <i>VEG+FRUIT</i>	2896lm	3250K <i>FASHION</i>	3194lm

### Filtros / Filters

	Antideslumbrante / Anti-glare ■ A04P-1003-02	
	Prismatico / Prismatic ■ A47G-1003-92	



Carril / Track p. 254-257



Acabado negro o acabado blanco con embellecedor blanco o cromado  
Black finish or white finish with white or chrome baffle

Campos / Fields

Acabados/Finishes

<b>1</b>	<b>2</b>	<b>3</b>	<b>4</b>	<b>5</b>	<b>6</b>	<b>7</b>	<b>8</b>	<b>9</b>	<b>10</b>
----------	----------	----------	----------	----------	----------	----------	----------	----------	-----------

Familia Family	Modelo Model	Fuente de luz Lighting source	CRI / °K	Potencia (W) Power (W)	Voltaje Voltage	Óptica Light beam	Regulación Dimmable	Aro Ring	Embellecedor Baffle
-------------------	-----------------	----------------------------------	----------	---------------------------	--------------------	----------------------	------------------------	-------------	------------------------

<b>1</b>	<b>4</b>	<b>5</b>	<b>7</b>	<b>9</b>
1003 ARROW	38 CRI90 2700K 39 CRI90 3000K 40 CRI90 4000K 44 CRI82 2000K (MEAT) 46 CRI88 2500K (BREAD) 47 CRI92 4000K (FISH) 48 CRI96 3000K (VEG+FRUIT) 51 CRI95 3250K (FASHION)	10 8,8W 20 18,6W 24 24W 30 27,4W	2 20° 4 40° 5 55°	01 □ 02 ■
<b>2</b>		<b>6</b>	<b>8</b>	<b>10</b>
A Medium B Large		B AC220-240V	O ON-OFF D DALI M CASAMBI	01 □ 02 ■ 32 □
<b>3</b>				
L LED COB				

<b>1</b>	<b>2</b>	<b>3</b>	<b>4</b>	<b>5</b>	<b>6</b>	<b>7</b>	<b>8</b>	<b>9-10</b>	<b>9-10</b>
1003	A B	L	38 39 40 51 38 39 40 51 44 46 47 48 38 39 40 51	10 20 24 30	B	2 4 5	O D M O D M O D M	01 - 01 32	02 - 02

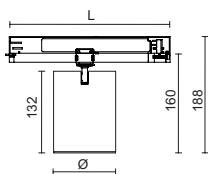

<b>1</b>	<b>2</b>	<b>5</b>	<b>8</b>	L(mm)	Ø(mm)
1003	A	10	O	170	79
		20	D	260	
			M	234	
	B	24 30	O	234	
			D	260	
			M	234	

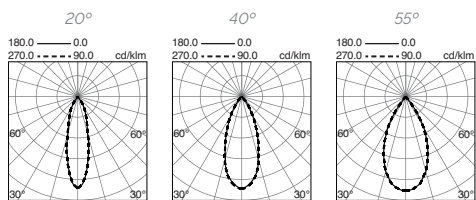



Añadir bases / Add bases (p.145)

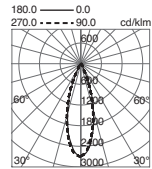

796B-L3110I

h (m)	d (m)	E (lux)
1,00	0,57	1913
2,00	1,14	478
3,00	1,71	213
4,00	2,28	120
5,00	2,85	77

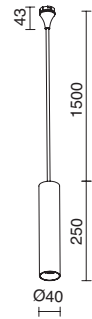

LED COB 9.2W 1250lm 3000K

□ 796B-L3110I-01

■ 796B-L3110I-02



Añadir bases / Add bases (p.145)

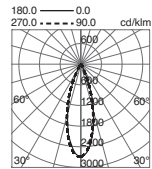

796A-L3110I

h (m)	d (m)	E (lux)
1,00	0,57	1913
2,00	1,14	478
3,00	1,71	213
4,00	2,28	120
5,00	2,85	77



LED COB 9.2W 1250lm 3000K

□ 796A-L3110I-01

■ 796A-L3110I-02



Acabado blanco o negro / White or black finish

Accesorios / Accessories

<p>Filtro suavizante Softener filter</p> <p>□ A47D-796-92</p>	<p>Filtro extensivo Extensive filter</p> <p>□ A47E-796-92</p>	<p>Filtro elongador Extension filter</p> <p>□ A47C-796-92</p>	<p>Rejilla antideslumbrante Anti-glare grille</p> <p>■ A04M-796-02</p>
<p>Embellecedor antideslumbrante / Anti-glare baffle</p> <p>■ A55A-796-02 ■ A55A-796-45 ■ A55A-796-46</p>			<p>796A-L3110I-01 A55A-796-45 A47C-796-92</p>
			<p>796A-L3110I-02 A55A-796-46 A04M-796-02</p>





**ON-OFF (10W) \***

**LC (inicio y fin / start and end) 10W**

- B19G-X3315A-01
- B19G-X3315A-02

- B19G-X33RFB-01
- B19G-X33RFB-02



**1-10V (10W)**

**DALI (10W)**

**CASAMBI (10W)**

- B19G-X33R1B-01
- B19G-X33R1B-02

- B19G-X33RDB-01
- B19G-X33RDB-02

- B19G-X33RMB-01
- B19G-X33RMB-02

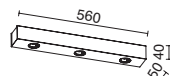
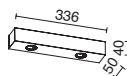
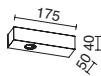
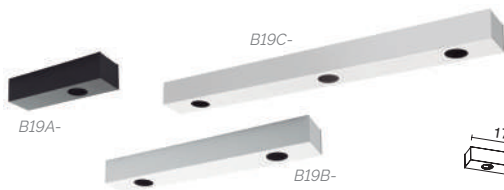

**L175 (10W)**

**L336 (20W)**

**L560 (30W)**

- B19A-X3310B-01
- B19A-X3310B-02

- B19B-X3340B-01
- B19B-X3340B-02

- B19C-X3330B-01
- B19C-X3330B-02



**Ø100 (10W)**

**Ø260 (30W)**

- B19E-X3310B-01
- B19E-X3310B-02

- B19F-X3330B-01
- B19F-X3330B-02

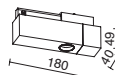

**10W**

*Carril / Track p. 254-257*

- B19H-X3310B-01
- B19H-X3310B-02



ALU

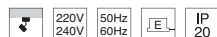

*Acabado blanco o negro / White or black finish*

*B19G, con Driver remoto  
B19G, with Remote Driver*



B19C-X3330B-02  
796A-L3110I-02  
2x 796B-L3110I-01



B19G-X3315A-01  
796A-L3110I-01



B19B-X3340B-02  
2x 796A-L3110I-02



B28A-X33X2B-02  
B19H-X3310B-02  
796B-L3110I-02



B19G-X33RFB-02  
796A-L3110I-02



B28A-X33X2B-01  
B19H-X3310B-01  
796A-L3110I-01



B19F-X3330B-01  
3x 796B-L3110I-01



# HIDRA



## SPOTLIGHTS

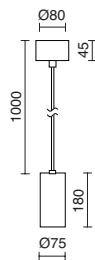

LED COB 18W 1575lm 3000K

- 832B-L3121B-01
- 832C-L3121B-01
- 832D-L3121B-01

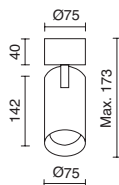

LED COB 18W 1575lm 3000K

- 834B-L3121B-01
- 834C-L3121B-01
- 834D-L3121B-01

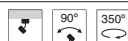

Acabado blanco con embellecedor plata, oro o negro / White finish with silver, gold or black baffle

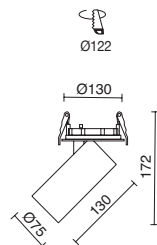

LED COB 18W 1575lm 3000K

- 833B-L3121B-01
- 833C-L3121B-01
- 833D-L3121B-01

Con Driver remoto  
With Remote Driver



• Carril no incluido.  
• Track not included.

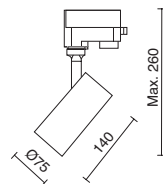

LED COB 18W 1575lm 3000K

- 836B-L3121B-01
- 836C-L3121B-01
- 836D-L3121B-01



Carril / Track p. 254-257



B-  
Plata / Silver

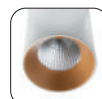

C-  
Oro / Gold



D-  
Negro / Black



Acabado blanco / White finish







LED SMD 30W / 40W / 50W

□ 983A-L41MPA-01

■ 983A-L41MPA-02



Adaptador para techo / Adapter for ceiling

□ B25-X33X2B-01

■ B25-X33X2B-02

SI



Ø99



Combinaciones / Combinations		
50W	3000K	5375lm
	4000K	5859lm
40W	3000K	4362lm
	4000K	4771lm
30W	3000K	3560lm
	4000K	3908lm



Carril / Track p. 254-257

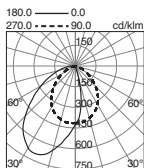

Acabado blanco o negro / White or black finish



• Carril no incluido.  
• Track not included.

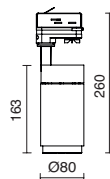

LED COB 25W

- 803B-L4125B6F-01
- 803B-L4125B6F-02



K SELECT	15°	60°
	2700K	1158lm
3000K	1280lm	2285lm
4000K	1224lm	2182lm

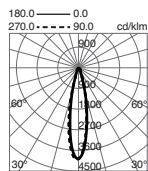

2700K

h (m)	d (m)	E (lux)
1,00	0,35	4700
2,00	0,70	522
3,00	1,05	522
4,00	1,40	294
5,00	1,75	188

3000K

h (m)	d (m)	E (lux)
1,00	0,35	5308
2,00	0,70	590
3,00	1,05	590
4,00	1,40	332
5,00	1,75	212

4000K

h (m)	d (m)	E (lux)
1,00	0,35	5153
2,00	0,70	573
3,00	1,05	573
4,00	1,40	322
5,00	1,75	206

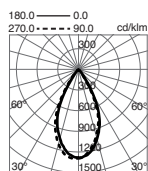
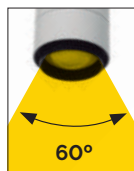

2700K

h (m)	d (m)	E (lux)
1,00	0,93	2654
2,00	1,86	295
3,00	2,79	295
4,00	3,72	166
5,00	4,65	106

3000K

h (m)	d (m)	E (lux)
1,00	0,93	2971
2,00	1,86	330
3,00	2,79	330
4,00	3,72	186
5,00	4,65	119

4000K

h (m)	d (m)	E (lux)
1,00	0,93	2867
2,00	1,86	319
3,00	2,79	319
4,00	3,72	179
5,00	4,65	115



Adaptador para techo / Adapter for ceiling

- B25-X33X2B-01
- B25-X33X2B-02

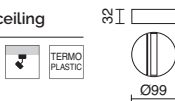

Carril / Track p. 254-257



Acabado blanco o negro / White or black finish



• Carril no incluido.  
• Track not included.

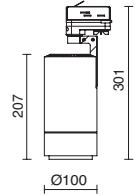

### 3000K

LED COB 35W 1570lm (10°)-3270lm (60°)

- 803A-L3135B-01
- 803A-L3135B-02

### 4000K

LED COB 35W 1790lm (10°)-3720lm (60°)

- 803A-L3335B-01
- 803A-L3335B-02



10°-60°

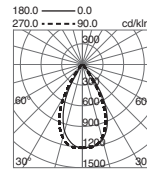
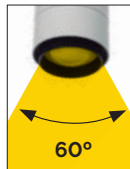
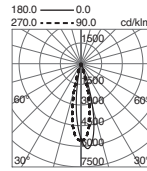

### 3000K

h (m)	d (m)	E (lux)
1,00	0,21	21818
2,00	0,42	5455
3,00	0,63	2424
4,00	0,84	1364
5,00	1,05	873

### 4000K

h (m)	d (m)	E (lux)
1,00	0,21	23602
2,00	0,42	5901
3,00	0,63	2622
4,00	0,84	1475
5,00	1,05	944

### 3000K

h (m)	d (m)	E (lux)
1,00	1,15	4595
2,00	2,30	1149
3,00	3,45	511
4,00	4,60	287
5,00	5,75	184

### 4000K

h (m)	d (m)	E (lux)
1,00	1,15	4941
2,00	2,30	1235
3,00	3,45	549
4,00	4,60	309
5,00	5,75	198



### Adaptador para techo / Adapter for ceiling

- B25-X33X2B-01
- B25-X33X2B-02

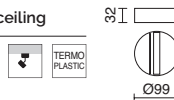

Carril / Track p. 254-257



Acabado blanco o negro / White or black finish



Textura La Roca Village, Barcelona

180.0 — 0.0  
270.0 - - - 90.0 cd/klm

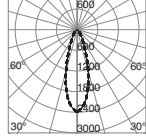

### 825Q-L3835B

h (m)	d (m)	E (lux)
1,00	0,60	5934
2,00	1,20	1484
3,00	1,80	659
4,00	2,40	371
5,00	3,00	237

### 825Q-L3135B

h (m)	d (m)	E (lux)
1,00	0,60	7808
2,00	1,20	1952
3,00	1,80	868
4,00	2,40	488
5,00	3,00	312

### 825Q-L3335B

h (m)	d (m)	E (lux)
1,00	0,60	8268
2,00	1,20	2067
3,00	1,80	919
4,00	2,40	517
5,00	3,00	331

180.0 — 0.0  
270.0 - - - 90.0 cd/klm

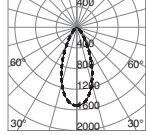

### 825R-L3835B

h (m)	d (m)	E (lux)
1,00	0,82	3898
2,00	1,64	975
3,00	2,46	433
4,00	3,28	244
5,00	4,10	156

### 825R-L3135B

h (m)	d (m)	E (lux)
1,00	0,82	5129
2,00	1,64	1282
3,00	2,46	570
4,00	3,28	321
5,00	4,10	205

### 825R-L3335B

h (m)	d (m)	E (lux)
1,00	0,82	5461
2,00	1,64	1365
3,00	2,46	607
4,00	3,28	341
5,00	4,10	218

180.0 — 0.0  
270.0 - - - 90.0 cd/klm

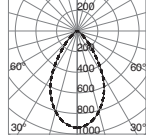

### 825S-L3835B

h (m)	d (m)	E (lux)
1,00	1,20	2174
2,00	2,40	544
3,00	3,60	242
4,00	4,80	136
5,00	6,00	87

### 825S-L3135B

h (m)	d (m)	E (lux)
1,00	1,20	2861
2,00	2,40	715
3,00	3,60	318
4,00	4,80	179
5,00	6,00	114

### 825S-L3335B

h (m)	d (m)	E (lux)
1,00	1,20	3062
2,00	2,40	766
3,00	3,60	340
4,00	4,80	191
5,00	6,00	122



• Carril no incluido.  
• Track not included.

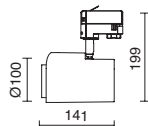

### 2700K

LED 35W 2296lm

- 825Q-L3835B-01
- 825Q-L3835B-02

- 825R-L3835B-01
- 825R-L3835B-02

- 825S-L3835B-01
- 825S-L3835B-02

### 3000K

LED 35W 3000lm

- 825Q-L3135B-01
- 825Q-L3135B-02

- 825R-L3135B-01
- 825R-L3135B-02

- 825S-L3135B-01
- 825S-L3135B-02

### 4000K

LED 35W 3200lm

- 825Q-L3335B-01
- 825Q-L3335B-02

- 825R-L3335B-01
- 825R-L3335B-02

- 825S-L3335B-01
- 825S-L3335B-02



### Accesorios / Accessories

ALU + ACER



Rejilla antideslumbrante  
Anti-glare grille

- A60A-825-01
- A60A-825-02



Embellecedor antideslumbrante  
Anti-glare embellisher

- A60B-825-01
- A60B-825-02



Visera antideslumbrante  
Anti-glare visor

- A60C-825-01
- A60C-825-02



Aletas antideslumbrantes  
Anti-glare barndoor

- A60D-825-02



Carril / Track p. 254-257



Adaptador para techo / Adapter for ceiling

- B25-X33X2B-01
- B25-X33X2B-02

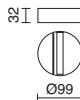

Acabado blanco o negro / White or black finish

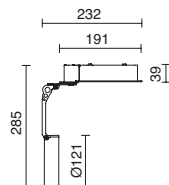

### 3000K

LED COB 17W 2180lm

- 772L-L3125B-01
- 772L-L3125B-02
- 772L-L3125B-03

### 4000K

LED COB 17W 2250lm

- 772L-L3325B-01
- 772L-L3325B-02
- 772L-L3325B-03



- 772L-L31RDB-01
- 772L-L31RDB-02
- 772L-L31RDB-03

- 772L-L33RDB-01
- 772L-L33RDB-02
- 772L-L33RDB-03



LED COB 17W 2210lm

- 772M-L3125B-01
- 772M-L3125B-02
- 772M-L3125B-03

LED COB 17W 2280lm

- 772M-L3325B-01
- 772M-L3325B-02
- 772M-L3325B-03



- 772M-L31RDB-01
- 772M-L31RDB-02
- 772M-L31RDB-03

- 772M-L33RDB-01
- 772M-L33RDB-02
- 772M-L33RDB-03



Filtros de conversión para pescado, marisco, verdura, carne o pan  
Conversion for fish, seafood, vegetables, meat or bread

	SEAFOOD	A14A-738-00	<i>for 3000K</i>
	VEG+FRUIT	A14A-738-00	
<hr/>			
	FISH	A14A-738-00	<i>for 4000K</i>
	MEAT	A14B-738-00	
	BREAD	A14C-738-00	

Porta filtros / Support for filters

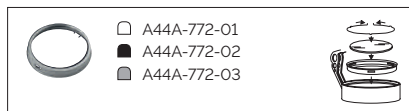

Aro customizable  
Customizable ring



Acabado blanco, negro o gris / White, black or grey finish



- Carril no incluído.
- Track not included.

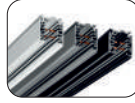

Carril / Track p. 254-257

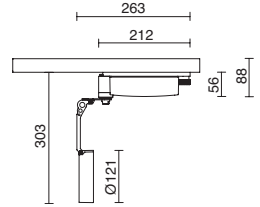

### 3000K

LED COB 17W 2180lm

- 772Q-L3125B-01
- 772Q-L3125B-02
- 772Q-L3125B-03

### 4000K

LED COB 17W 2250lm

- 772Q-L3325B-01
- 772Q-L3325B-02
- 772Q-L3325B-03

- 772Q-L3117B1M-01
- 772Q-L3117B1M-02
- 772Q-L3117B1M-03

- 772Q-L3317B1M-01
- 772Q-L3317B1M-02
- 772Q-L3317B1M-03

CASAMBI

LED COB 17W 2210lm

- 772R-L3125B-01
- 772R-L3125B-02
- 772R-L3125B-03

LED COB 17W 2280lm

- 772R-L3325B-01
- 772R-L3325B-02
- 772R-L3325B-03

- 772R-L3117B2M-01
- 772R-L3117B2M-02
- 772R-L3117B2M-03

- 772R-L3317B2M-01
- 772R-L3317B2M-02
- 772R-L3317B2M-03

CASAMBI

### Porta filtros / Support for filters

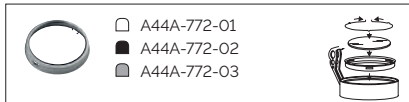

Filtros de conversión para pescado, marisco, verdura, carne o pan  
Conversion for fish, seafood, vegetables, meat or bread

	SEAFOOD	A14A-738-00	for 3000K
	VEG+FRUIT	A14A-738-00	
	FISH	A14A-738-00	for 4000K
	MEAT	A14B-738-00	
	BREAD	A14C-738-00	

Bar Mono, Sant Cugat del Vallès

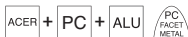

Acabado blanco, negro o gris / White, black or grey finish

# CRETE 1

SPOTLIGHTS

48V  
DC

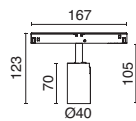

## 2700K

LED COB 6,6W 640lm

□ 1032A-L3807V20-01

■ 1032A-L3807V20-02

□ 1032A-L3807V2D-01

■ 1032A-L3807V2D-02

## 3000K

LED COB 6,6W 688lm

□ 1032A-L3907V20-01

■ 1032A-L3907V20-02

□ 1032A-L3907V2D-01

■ 1032A-L3907V2D-02



□ 1032A-L3807V30-01

■ 1032A-L3807V30-02

□ 1032A-L3807V3D-01

■ 1032A-L3807V3D-02

□ 1032A-L3907V30-01

■ 1032A-L3907V30-02

□ 1032A-L3907V3D-01

■ 1032A-L3907V3D-02



Carril 48V / 48V Track p. 166-173



Driver 48V p.795



Acabado blanco o negro / White or black finish

Con Driver remoto  
With Remote Driver

# CRETE 1

SPOTLIGHTS

48V  
DC

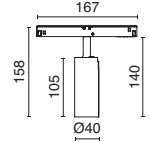

## 2700K

LED COB 11W 962lm

□ 1032B-L3811V10-01

■ 1032B-L3811V10-02

□ 1032B-L3811V1D-01

■ 1032B-L3811V1D-02

□ 1032B-L3811V20-01

■ 1032B-L3811V20-02

□ 1032B-L3811V2D-01

■ 1032B-L3811V2D-02

□ 1032B-L3811V30-01

■ 1032B-L3811V30-02

□ 1032B-L3811V3D-01

■ 1032B-L3811V3D-02

## 3000K

LED COB 11W 1011lm

□ 1032B-L3911V10-01

■ 1032B-L3911V10-02

□ 1032B-L3911V1D-01

■ 1032B-L3911V1D-02

□ 1032B-L3911V20-01

■ 1032B-L3911V20-02

□ 1032B-L3911V2D-01

■ 1032B-L3911V2D-02

□ 1032B-L3911V30-01

■ 1032B-L3911V30-02

□ 1032B-L3911V3D-01

■ 1032B-L3911V3D-02



Carril 48V / 48V Track p. 166-173

Driver 48V p.795



Acabado blanco o negro / White or black finish

Con Driver remoto  
With Remote Driver

# CRETE 1

SPOTLIGHTS

48V  
DC

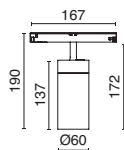

## 2700K

LED COB 18.1W 1783lm

- 1032C-L3818V20-01
- 1032C-L3818V20-02

## 3000K

LED COB 18.1W 1885lm

- 1032C-L3918V20-01
- 1032C-L3918V20-02



- 1032C-L3818V2D-01
- 1032C-L3818V2D-02

- 1032C-L3918V2D-01
- 1032C-L3918V2D-02



- 1032C-L3818V30-01
- 1032C-L3818V30-02

- 1032C-L3918V30-01
- 1032C-L3918V30-02



- 1032C-L3818V3D-01
- 1032C-L3818V3D-02

- 1032C-L3918V3D-01
- 1032C-L3918V3D-02



Carril 48V / 48V Track p. 166-173



Driver 48V p.795



Acabado blanco o negro / White or black finish

Con Driver remoto  
With Remote Driver



# CRETE 1

SPOTLIGHTS

48V  
DC

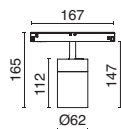

2700K

LED COB 12,9W 1151lm

□ 1032D-L3813VV0-01

■ 1032D-L3813VV0-02

□ 1032D-L3813VVD-01

■ 1032D-L3813VVD-02

3000K

LED COB 12,9W 1208lm

□ 1032D-L3913VV0-01

■ 1032D-L3913VV0-02

□ 1032D-L3913VVD-01

■ 1032D-L3913VVD-02



Driver 48V p.795



Carril 48V / 48V Track p. 166-173



Acabado blanco o negro / White or black finish

Con Driver remoto  
With Remote Driver

# CRETE 2

SPOTLIGHTS

48V  
DC

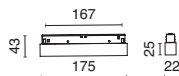

## 2700K

LED SMD 7,5W 750lm

- 1038A-L3808V10-01
- 1038A-L3808V10-02



## 3000K

LED SMD 7,5W 810lm

- 1038A-L3908V10-01
- 1038A-L3908V10-02

- 1038A-L3808V1D-01
- 1038A-L3808V1D-02

- 1038A-L3908V1D-01
- 1038A-L3908V1D-02



- 1038A-L3808V30-01
- 1038A-L3808V30-02

- 1038A-L3908V30-01
- 1038A-L3908V30-02

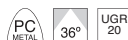

- 1038A-L3808V3D-01
- 1038A-L3808V3D-02

- 1038A-L3908V3D-01
- 1038A-L3908V3D-02



- 1038A-L3808V50-01
- 1038A-L3808V50-02

- 1038A-L3908V50-01
- 1038A-L3908V50-02



- 1038A-L3808V5D-01
- 1038A-L3808V5D-02

- 1038A-L3908V5D-01
- 1038A-L3908V5D-02



Carril 48V / 48V Track p. 166-173



Driver 48V p.795



ALU



Acabado blanco o negro / White or black finish

Con Driver remoto  
With Remote Driver

# CRETE 2

SPOTLIGHTS

48V  
DC

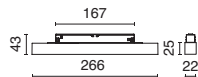

## 2700K

LED SMD 15W 1500lm

- 1038B-L3815V10-01
- 1038B-L3815V10-02

## 3000K

LED SMD 7.5W 810lm

- 1038B-L3915V10-01
- 1038B-L3915V10-02



- 1038B-L3815V1D-01
- 1038B-L3815V1D-02

- 1038B-L3915V1D-01
- 1038B-L3915V1D-02



- 1038B-L3815V30-01
- 1038B-L3815V30-02

- 1038B-L3915V30-01
- 1038B-L3915V30-02



- 1038B-L3815V3D-01
- 1038B-L3815V3D-02

- 1038B-L3915V3D-01
- 1038B-L3915V3D-02



- 1038B-L3815V50-01
- 1038B-L3815V50-02

- 1038B-L3915V50-01
- 1038B-L3915V50-02



- 1038B-L3815V5D-01
- 1038B-L3815V5D-02

- 1038B-L3915V5D-01
- 1038B-L3915V5D-02



Carril 48V / 48V Track p. 166-173



Driver 48V p.795



ALU



Acabado blanco o negro / White or black finish

Con Driver remoto  
With Remote Driver

# CRETE 2

SPOTLIGHTS

48V  
DC

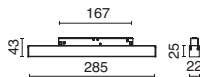

2700K

LED SMD 6.3W 660lm

1038C-L3806VBO-01

1038C-L3806VBO-02

3000K

LED SMD 6.3W 696lm

1038C-L3906VBO-01

1038C-L3906VBO-02

1038C-L3806VBD-01

1038C-L3806VBD-02

1038C-L3906VBD-01

1038C-L3906VBD-02

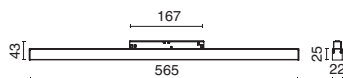

2700K

LED SMD 12.6W 1319lm

1038D-L3813VBO-01

1038D-L3813VBO-02

3000K

LED SMD 12.6W 1396lm

1038D-L3913VBO-01

1038D-L3913VBO-02

1038D-L3813VBD-01

1038D-L3813VBD-02

1038D-L3913VBD-01

1038D-L3913VBD-02



Carril 48V / 48V Track p. 166-173

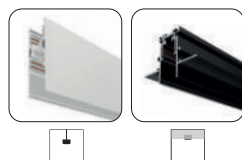
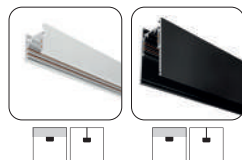

Driver 48V p.795



Acabado blanco o negro / White or black finish

Con Driver remoto  
With Remote Driver

# CRETE 2

SPOTLIGHTS

48V  
DC

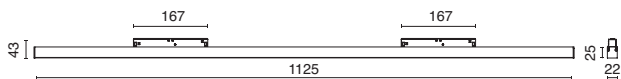

## 2700K

LED SMD 25,2W 2683lm

□ 1038E-L3825VBO-01

■ 1038E-L3825VBO-02

□ 1038E-L3825VBD-01

■ 1038E-L3825VBD-02

## 3000K

LED SMD 25,2W 2786lm

□ 1038E-L3925VBO-01

■ 1038E-L3925VBO-02

□ 1038E-L3925VBD-01

■ 1038E-L3925VBD-02



Acabado blanco o negro / White or black finish

Con Driver remoto  
With Remote Driver

# TRACK 48V

SPOTLIGHTS

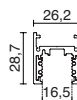
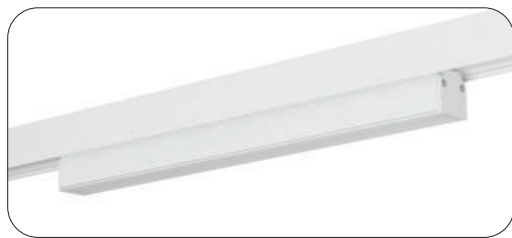

1m

- B32A-X33X2V-01
- B32A-X33X2V-02

2m

- B32B-X33X2V-01
- B32B-X33X2V-02

3m

- B32C-X33X2V-01
- B32C-X33X2V-02



ALU

48V DC



IP 20

Acabado blanco o negro / White or black finish



## EJEMPLOS DE INSTALACIÓN PARA TRACK 48V INSTALLATION EXAMPLES FOR TRACK 48V

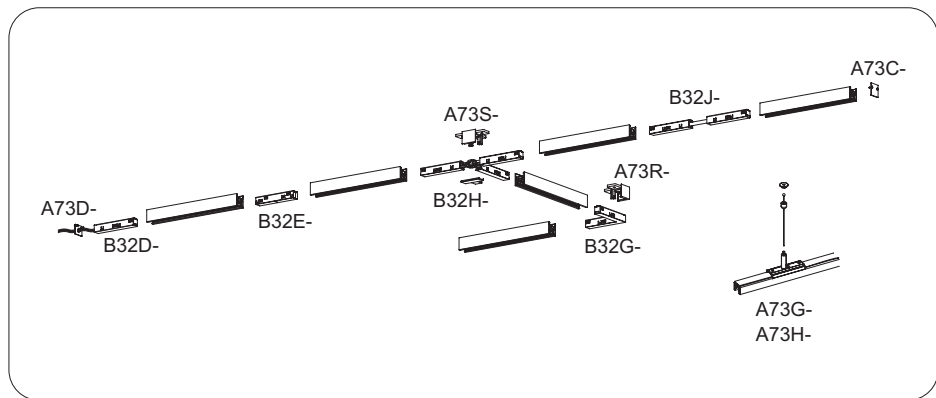

## Accesorios / Accessories

### Caja de conexión Box connection

- B32K-X33X2V-01
- B32K-X33X2V-02



### Kit suspension cable acero Suspension kit w/steel cable

- A73G-1032-38

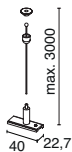

### Fuente de alimentación superficie Surface power supply

- B32L-X33A1V-01
- B32L-X33A1V-02

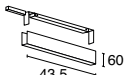

230Vac/48Vdc  
100W

### Kit suspension uniones cable acero Suspension kit for junctions w/steel cable

- A73H-1032-38

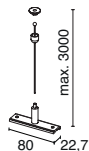

### Fuente de alimentación suspensión Power supply for suspension

- B32M-X33A1V-01
- B32M-X33A1V-02

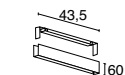

230Vac/48Vdc  
100W

### Herramienta de corte conductores Cutting tool for conductors

- A73U-1032-01



### Tapa final Dead end

- A73C-1032-01
- A73C-1032-02



### Unión mecánica en "L" Mechanical "L" junction

- A73R-1032-01
- A73R-1032-02

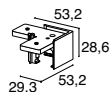

### Tapa final con agujero End cap with hole

- A73D-1032-01
- A73D-1032-02



### Unión mecánica en "T" Mechanical "T" junction

- A73S-1032-01
- A73S-1032-02

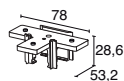

### Alimentación final Live end

- B32D-X33X2V-01
- B32D-X33X2V-02



### Codo con contactos 90° junction with contacts

- B32G-X33X2V-01
- B32G-X33X2V-02



### Unión con contacto Electrical straight coupling

- B32E-X33X2V-01
- B32E-X33X2V-02



### Unión en "T" con contactos "T" coupling with contacts

- B32H-X33X2V-01
- B32H-X33X2V-02

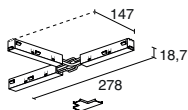

### Unión sin contacto Straight coupling w/o contacts

- B32F-X33X2V-01
- B32F-X33X2V-02

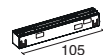

### Codo flexible con contactos Flexible junction with contacts

- B32J-X33X2V-01
- B32J-X33X2V-02



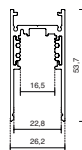

- 1m**
- B34A-X33X2V-01
  - B34A-X33X2V-02

- 2m**
- B34B-X33X2V-01
  - B34B-X33X2V-02

- 3m**
- B34C-X33X2V-01
  - B34C-X33X2V-02



ALU

48V DC  IP 20

Acabado blanco o negro / White or black finish



## EJEMPLOS DE INSTALACIÓN PARA TRACK 48V INSTALLATION EXAMPLES FOR TRACK 48V

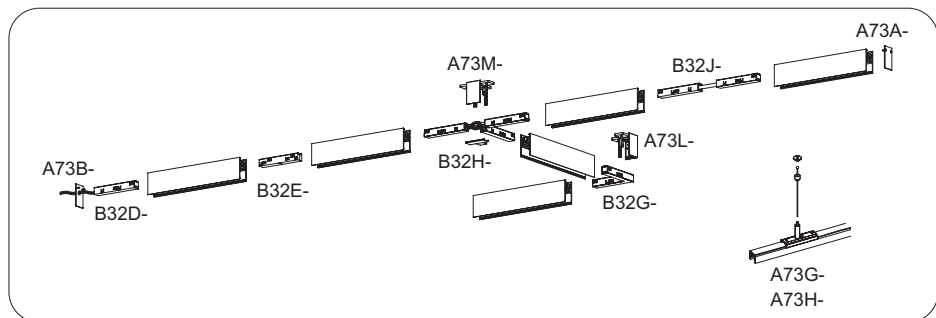



## Accesorios / Accessories

### Caja de conexión Box connection

- B32K-X33X2V-01
- B32K-X33X2V-02



### Kit suspension cable acero Suspension kit w/steel cable

- A73G-1032-38

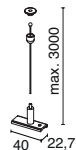

### Fuente de alimentación superficie Surface power supply

- B32L-X33A1V-01
- B32L-X33A1V-02

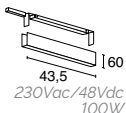

### Kit suspension uniones cable acero Suspension kit for junctions w/steel cable

- A73H-1032-38

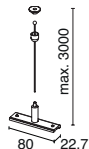

### Fuente de alimentación suspensión Power supply for suspension

- B32M-X33A1V-01
- B32M-X33A1V-02

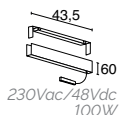

### Herramienta de corte conductores Cutting tool for conductors

- A73U-1032-01



### Tapa final Dead end

- A73A-1032-01
- A73A-1032-02



### Unión mecánica en "L" Mechanical "L" junction

- A73L-1032-01
- A73L-1032-02

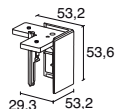

### Tapa final con agujero End cap with hole

- A73B-1032-01
- A73B-1032-02

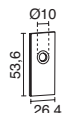

### Unión mecánica en "T" Mechanical "T" junction

- A73M-1032-01
- A73M-1032-02

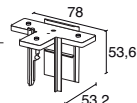

### Tapa frontal Dead end

- A73T-1032-01
- A73T-1032-02



### Codo con contactos 90° junction with contacts

- B32G-X33X2V-01
- B32G-X33X2V-02

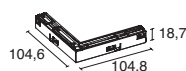

### Alimentación final Live end

- B32D-X33X2V-01
- B32D-X33X2V-02



### Unión en "T" con contactos "T" coupling with contacts

- B32H-X33X2V-01
- B32H-X33X2V-02

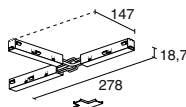

### Unión con contacto Electrical straight coupling

- B32E-X33X2V-01
- B32E-X33X2V-02

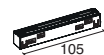

### Codo flexible con contactos Flexible junction with contacts

- B32J-X33X2V-01
- B32J-X33X2V-02



### Unión sin contacto Straight coupling w/o contacts

- B32F-X33X2V-01
- B32F-X33X2V-02

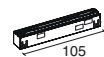

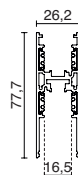

1m

- B33A-X33X2V-01
- B33A-X33X2V-02

2m

- B33B-X33X2V-01
- B33B-X33X2V-02

3m

- B33C-X33X2V-01
- B33C-X33X2V-02



ALU

48V DC IP 20

Acabado blanco o negro / White or black finish



## EJEMPLOS DE INSTALACIÓN PARA TRACK 48V INSTALLATION EXAMPLES FOR TRACK 48V

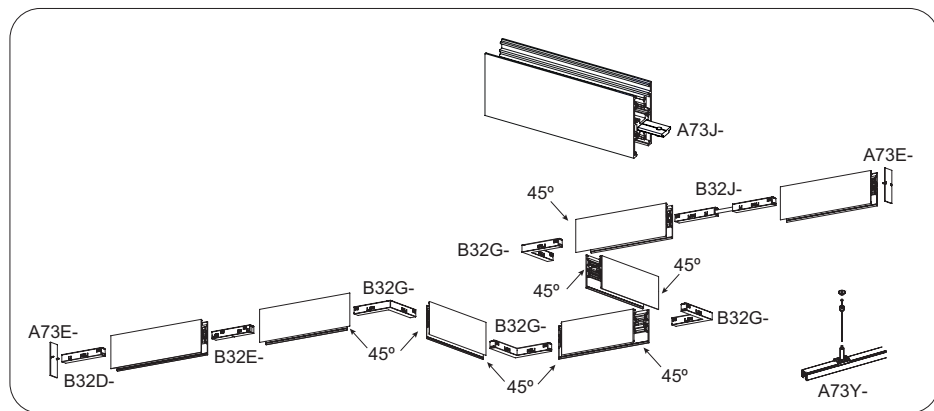

## Accesorios / Accessories

### Caja de conexión Box connection

- B32K-X33X2V-01
- B32K-X33X2V-02



### Kit suspension cable acero Suspension kit w/steel cable

- A73Y-1032-38

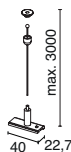

### Fuente de alimentación suspensión Power supply for suspension

- B32M-X33A1V-01
- B32M-X33A1V-02

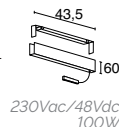

### Herramienta de corte conductores Cutting tool for conductors

- A73U-1032-01



### Tapa final Dead end

- A73E-1032-01
- A73E-1032-02



### Pletina de unión Joint plates

- A73J-1032-01
- A73J-1032-02

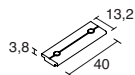

### Tapa frontal Dead end

- A73T-1032-01
- A73T-1032-02



### Codo con contactos 90° junction with contacts

- B32G-X33X2V-01
- B32G-X33X2V-02



### Alimentación final Live end

- B32D-X33X2V-01
- B32D-X33X2V-02



### Codo flexible con contactos Flexible junction with contacts

- B32J-X33X2V-01
- B32J-X33X2V-02



### Unión con contacto Electrical straight coupling

- B32E-X33X2V-01
- B32E-X33X2V-02



### Unión sin contacto Straight coupling w/o contacts

- B32F-X33X2V-01
- B32F-X33X2V-02

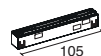

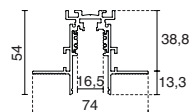
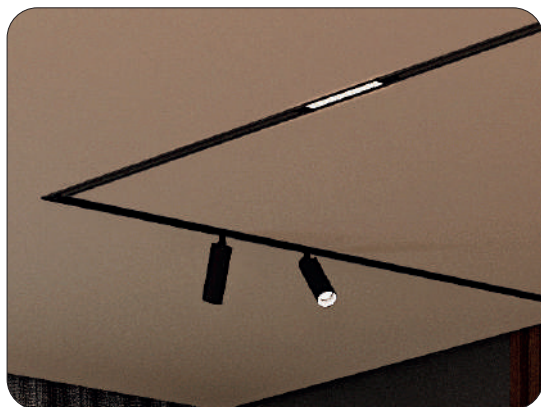
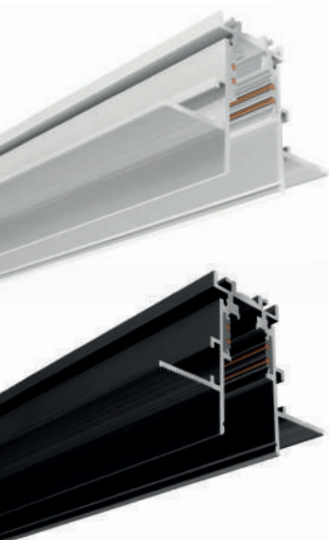

1m

- B35A-X33X2V-01
- B35A-X33X2V-02

2m

- B35B-X33X2V-01
- B35B-X33X2V-02

3m

- B35C-X33X2V-01
- B35C-X33X2V-02



ALU

48V DC



IP 20

Acabado blanco o negro / White or black finish



## EJEMPLOS DE INSTALACIÓN PARA TRACK 48V INSTALLATION EXAMPLES FOR TRACK 48V

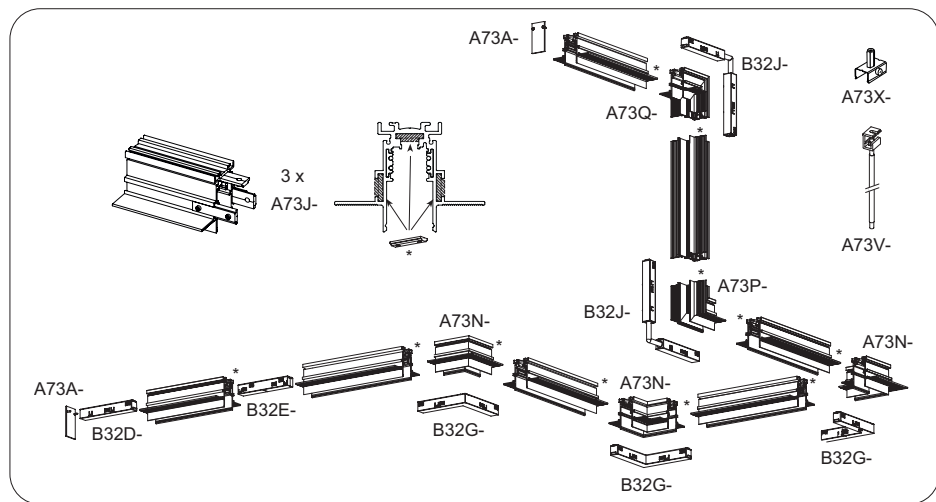

## Accesorios / Accessories

Codo horizontal trimless  
90° horizontal trimless junction

- A73N-1032-01
- A73N-1032-02

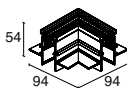

Kit suspension cable acero  
Suspension kit w/steel cable

- A73V-1032-39



Codo vertical externo trimless  
90° external trimless junction

- A73P-1032-01
- A73P-1032-02



Grapa fijación M6  
M6x1m clam

- A73X-1032-38

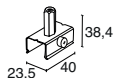

Codo vertical interno trimless  
90° internal trimless junction

- A73Q-1032-01
- A73Q-1032-02



Herramienta de corte conductores  
Cutting tool for conductors

- A73U-1032-01



Plantilla  
Template

- A73F-1032-38



Pletina de unión  
Joint plates

- A73J-1032-01
- A73J-1032-02

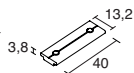

Tapa final  
Dead end

- A73A-1032-01
- A73A-1032-02



Tapa final con agujero  
End cap with hole

- A73B-1032-01
- A73B-1032-02

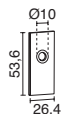

Alimentación final  
Live end

- B32D-X33X2V-01
- B32D-X33X2V-02



Codo con contactos  
90° junction with contacts

- B32G-X33X2V-01
- B32G-X33X2V-02



Unión con contacto  
Electrical straight coupling

- B32E-X33X2V-01
- B32E-X33X2V-02



Codo flexible con contactos  
Flexible junction with contacts

- B32J-X33X2V-01
- B32J-X33X2V-02



Unión sin contacto  
Straight coupling w/o contacts

- B32F-X33X2V-01
- B32F-X33X2V-02



Tapa frontal  
Dead end

- A73T-1032-01
- A73T-1032-02





# Led strips

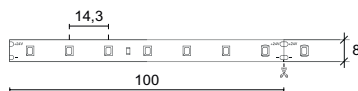
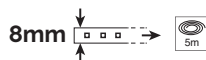

### 2700K

12,6W/m 1248lm/m

201AS-L3012FCO-00

### 3000K

12,6W/m 1344lm/m

201AS-L3112FCO-00

### 4000K

12,6W/m 1360lm/m

201AS-L3312FCO-00



**Conector tira-cable**  
Cable strip connector

CONAS-B03A-KIT

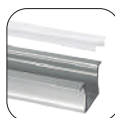

**Perfiles**  
Profiles

p.196



**Alimentadores**  
Power supplies

p.211

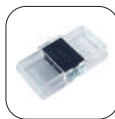

**Conector tira-tira**  
Strip-strip connector

CONAS-B03B-KIT



**Controladores**  
Controllers

p.202



Recomendaciones de uso e instalación / Recommendations for use and installation (p.804)



# NILO BASIC

IP 67

LED STRIP

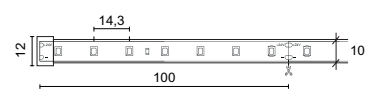
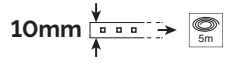
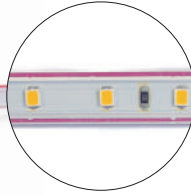

## 2700K

12,6W/m 1234lm/m

201DS-L3012FCO-00

## 3000K

12,6W/m 1329lm/m

201DS-L3112FCO-00

## 4000K

12,6W/m 1345lm/m

201DS-L3312FCO-00



**Conector tira-cable**  
Cable strip connector

CONDS-B03A-KIT

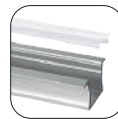

**Perfiles**  
Profiles

p.196



**Alimentadores**  
Power supplies

p.211



**Conector tira-tira**  
Strip-strip connector

CONDS-B03B-KIT



**Controladores**  
Controllers

p.202



Recomendaciones de uso e instalación / Recommendations for use and installation (p.804)

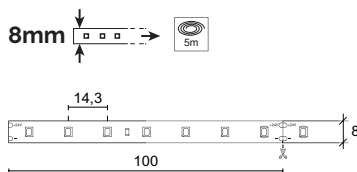

**2700K**

4.8W/m 505lm/m

200AS-L3805FCO-00

**3000K**

4.8W/m 530lm/m

200AS-L3905FCO-00

**4000K**

4.8W/m 580lm/m

200AS-L4005FCO-00

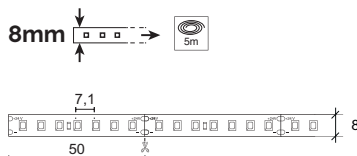
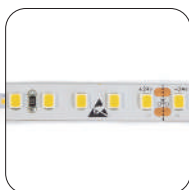

**2700K**

9.6W/m 979lm/m

200AS-L3810FCO-00

**3000K**

9.6W/m 1060lm/m

200AS-L3910FCO-00

**4000K**

9.6W/m 1150lm/m

200AS-L4010FCO-00



**Conector tira-cable**  
Cable strip connector

CONAS-B03A-KIT

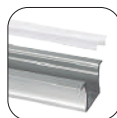

**Perfiles**  
Profiles

p.196



**Alimentadores**  
Power supplies

p.211

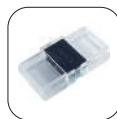

**Conector tira-tira**  
Strip-strip connector

CONAS-B03B-KIT



**Controladores**  
Controllers

p.202



Recomendaciones de uso e instalación / Recommendations for use and installation (p.804)

# NILO 8-10

IP 20

LED STRIP

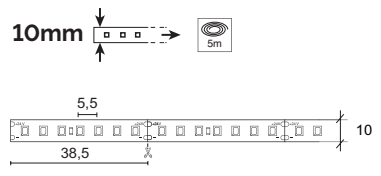

2700K	3000K	4000K
14,4W/m 1510lm/m	14,4W/m 1585lm/m	14,4W/m 1730lm/m
200AS-L3814FCO-00	200AS-L3914FCO-00	200AS-L4014FCO-00

180 LED/m 38,5mm

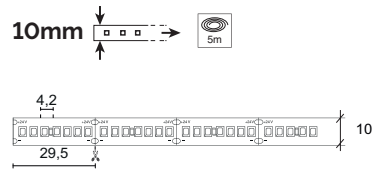
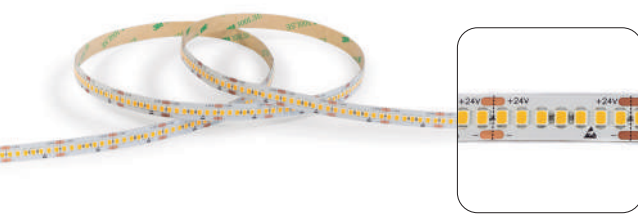

2700K	3000K	4000K
19,2W/m 2020lm/m	19,2W/m 2110lm/m	19,2W/m 2300lm/m
200AS-L3819FCO-00	200AS-L3919FCO-00	200AS-L4019FCO-00

238 LED/m 29,5mm



**Conector tira-cable**  
Cable strip connector

CONAS-B03A-KIT

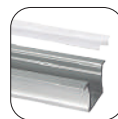

**Perfiles**  
Profiles

p.196



**Alimentadores**  
Power supplies

p.211

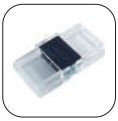

**Conector tira-tira**  
Strip-strip connector

CONAS-B03B-KIT



**Controladores**  
Controllers

p.202



Recomendaciones de uso e instalación / Recommendations for use and installation (p.804)

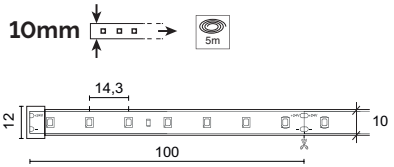
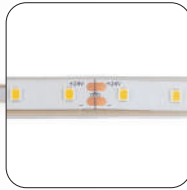

**2700K**  
4.8W/m 490lm/m

200DS-L3805FC0-00

**3000K**  
4.8W/m 510lm/m

200DS-L3905FC0-00

**4000K**  
4.8W/m 550lm/m

200DS-L4005FC0-00

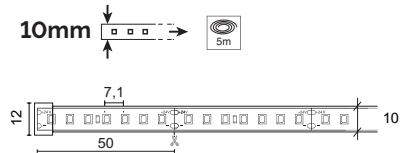
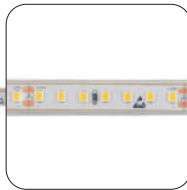

**2700K**  
9.6W/m 979/m

200DS-L3810FC0-00

**3000K**  
9.6W/m 1010lm/m

200DS-L3910FC0-00

**4000K**  
9.6W/m 1100lm/m

200DS-L4010FC0-00



**Conector tira-cable**  
Cable strip connector

CONDS-B03A-KIT

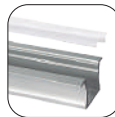

**Perfiles**  
Profiles

p.196



**Alimentadores**  
Power supplies

p.211



**Conector tira-tira**  
Strip-strip connector

CONDS-B03B-KIT



**Controladores**  
Controllers

p.202



Recomendaciones de uso e instalación / Recommendations for use and installation (p.804)

# NILO 8-10

IP 67

LED STRIP

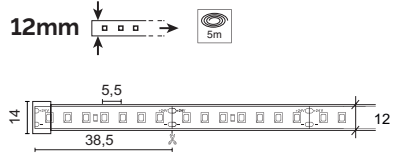

**2700K**

14.4W/m 1440lm/m

**3000K**

14.4W/m 1510lm/m

**4000K**

14.4W/m 1645lm/m

200DS-L3814FCO-00

200DS-L3914FCO-00

200DS-L4014FCO-00

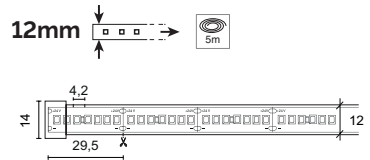

**2700K**

19.2W/m 1920lm/m

**3000K**

19.2W/m 2010lm/m

**4000K**

19.2W/m 2185lm/m

200DS-L3819FCO-00

200DS-L3919FCO-00

200DS-L4019FCO-00



**Conector tira-cable**  
Cable strip connector

CONDS-B03A-KIT

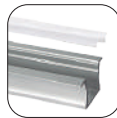

**Perfiles**  
Profiles

p.196



**Alimentadores**  
Power supplies

p.211



**Conector tira-tira**  
Strip-strip connector

CONDS-B03B-KIT



**Controladores**  
Controllers

p.202



Recomendaciones de uso e instalación / Recommendations for use and installation (p.804)

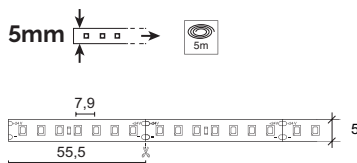
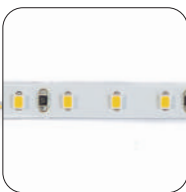

**2700K**

8,5W/m 950lm/m

203AS-L3809FCO-00

**3000K**

8,5W/m 980lm/m

203AS-L3909FCO-00

**4000K**

8,5W/m 1030lm/m

203AS-L4009FCO-00

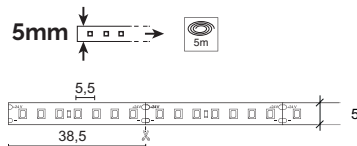

**2700K**

14,4W/m 1500lm/m

203AS-L3814FCO-00

**3000K**

14,4W/m 1550lm/m

203AS-L3914FCO-00

**4000K**

14,4W/m 1600lm/m

203AS-L4014FCO-00

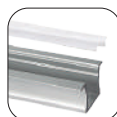

**Perfiles Profiles**

p.196



**Alimentadores Power supplies**

p.211



**Controladores Controllers**

p.202



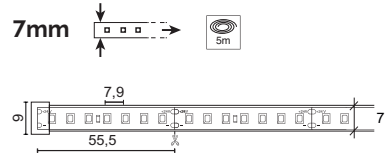

**2700K**

8,5W/m 920lm/m

203DS-L3809FCO-00

**3000K**

8,5W/m 950lm/m

203DS-L3909FCO-00

**4000K**

8,5W/m 1000lm/m

203DS-L4009FCO-00

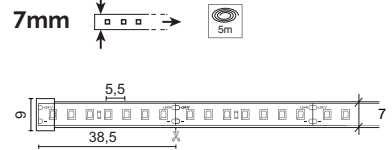

**2700K**

14,4W/m 1450lm/m

203DS-L3814FCO-00

**3000K**

14,4W/m 1500lm/m

203DS-L3914FCO-00

**4000K**

14,4W/m 1550lm/m

203DS-L4014FCO-00

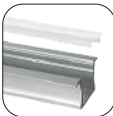

**Perfiles  
Profiles**

p.196



**Alimentadores  
Power supplies**

p.211



**Controladores  
Controllers**

p.202



Recomendaciones de uso e instalación / Recommendations for use and installation (p.804)

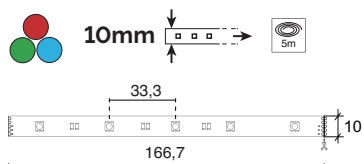

7,2W/m ● 65lm/m ● 130lm/m ● 55lm/m

200AS-L0407FC0-00

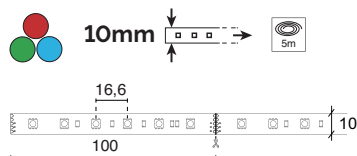

14,4W/m ● 132lm/m ● 360lm/m ● 108lm/m

200AS-L0414FC0-00

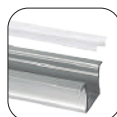

Perfiles  
Profiles

p.196



Alimentadores  
Power supplies

p.211



Controladores  
Controllers

p.202



Recomendaciones de uso e instalación / Recommendations for use and installation (p.804)



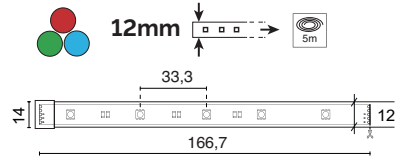

7,2W/m ● 65lm/m ● 130lm/m ● 55lm/m

200DS-L0407FCO-00

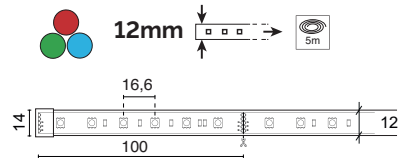

14,4W/m ● 132lm/m ● 360lm/m ● 108lm/m

200DS-L0414FCO-00

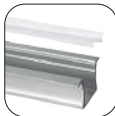

**Perfiles Profiles**  
p.196



**Alimentadores Power supplies**  
p.211



**Controladores Controllers**  
p.202



Recomendaciones de uso e instalación / Recommendations for use and installation (p.804)

# NILO RGB+W

IP 20

LED STRIP

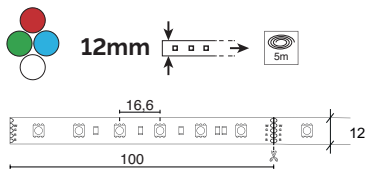
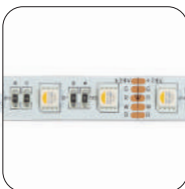

RGB 18,2W/m 838lm/m  
+  
W 5,5W/m 410lm/m **2700K**

RGB 18,2W/m 868lm/m  
+  
W 5,5W/m 440lm/m **3000K**

RGB 18,2W/m 868lm/m  
+  
W 5,5W/m 474lm/m **4000K**

200AS-L1416FCO-00

201AS-L1416FCO-00

202AS-L1416FCO-00



# NILO RGB+W

IP 67

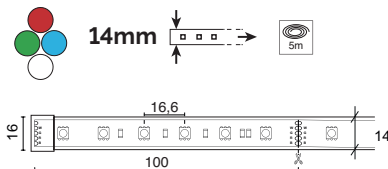
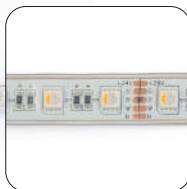

RGB 18,2W/m 838lm/m  
+  
W 5,5W/m 410lm/m **2700K**

RGB 18,2W/m 868lm/m  
+  
W 5,5W/m 440lm/m **3000K**

RGB 18,2W/m 868lm/m  
+  
W 5,5W/m 474lm/m **4000K**

200DS-L1416FCO-00

201DS-L1416FCO-00

202DS-L1416FCO-00

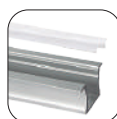

Perfiles  
Profiles  
p.196



Alimentadores  
Power supplies  
p.211



Controladores  
Controllers  
p.202

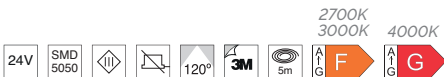

Recomendaciones de uso e instalación / Recommendations for use and installation (p.804)

# NILO DUAL

IP  
20

LED STRIP

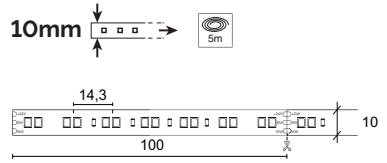

13.5W/m 700lm (2700K) 800lm (6500K)

206AS-L5213FC0-00



2700K ←

→ 6500K

**K SELECT** Temperatura de color seleccionable entre el rango indicado.  
Válida para adaptarse a nuestros ritmos biológicos (ciclo circadiano).

Selectable color temperature within the indicated range.  
Valid to adapt to our biological rhythms (circadian cycle).



En este caso, la Tira Led se ubica perimetralmente dentro de los paneles.  
In this case, the Led Strip is located perimeter inside the panels.

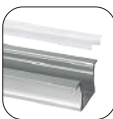

**Perfiles  
Profiles**  
p.196



**Alimentadores  
Power supplies**  
p.211



**Controladores  
Controllers**  
p.202



Recomendaciones de uso e instalación / Recommendations for use and installation (p.804)

# NILO EFFICIENCY

IP 20

LED STRIP

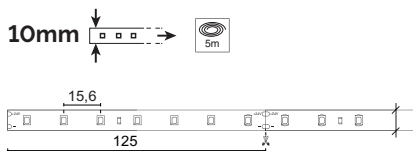

**2700K**

11W/m 1750lm/m

204AS-L3011FCO-00

**3000K**

11W/m 1950lm/m

204AS-L3111FCO-00

**4000K**

11W/m 2080lm/m

204AS-L3311FCO-00

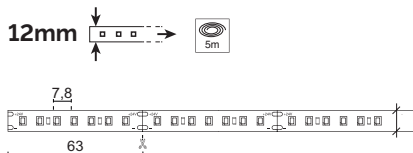

**2700K**

22W/m 3600lm/m

204AS-L3022FCO-00

**3000K**

22W/m 3700lm/m

204AS-L3122FCO-00

**4000K**

22W/m 4000lm/m

204AS-L3322FCO-00

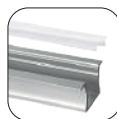

**Perfiles Profiles**

p.196



**Alimentadores Power supplies**

p.211



**Controladores Controllers**

p.202



2700K  
3000K  
4000K

Recomendaciones de uso e instalación / Recommendations for use and installation (p.804)

# NILO EFFICIENCY

IP 67

LED STRIP

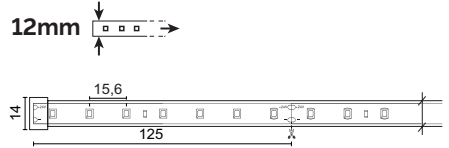
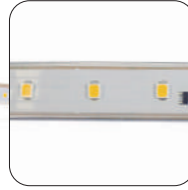

**2700K**  
11W/m 1750lm/m

**3000K**  
11W/m 1850lm/m

**4000K**  
11W/m 2000lm/m

204DS-L3011FC0-00

204DS-L3111FC0-00

204DS-L3311FC0-00

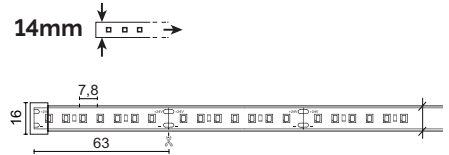

**2700K**  
22W/m 3550lm/m

**3000K**  
22W/m 3650lm/m

**4000K**  
22W/m 3850lm/m

204DS-L3022FC0-00

204DS-L3122FC0-00

204DS-L3322FC0-00

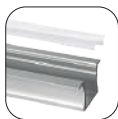

**Perfiles**  
**Profiles**  
p.196



**Alimentadores**  
**Power supplies**  
p.211



**Controladores**  
**Controllers**  
p.202



2700K  
3000K  
4000K

Recomendaciones de uso e instalación / Recommendations for use and installation (p.804)

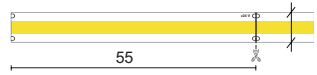
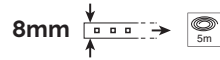
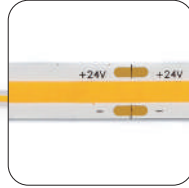
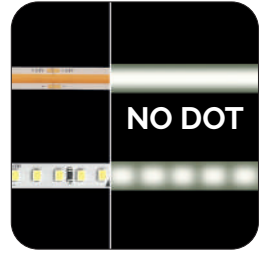

**2700K**

10W/m 900lm/m

202AC-L3810FCO-00

**3000K**

10W/m 950lm/m

202AC-L3910FCO-00

**4000K**

10W/m 1000lm/m

202AC-L4010FCO-00



**2700K**

14W/m 1250lm/m

202AC-L3814FCO-00

**3000K**

14W/m 1320lm/m

202AC-L3914FCO-00

**4000K**

14W/m 1400lm/m

202AC-L4014FCO-00

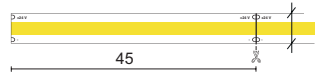

**Conector tira COB-cable**  
COB-cable strip connector

CONAC-B03A-KIT

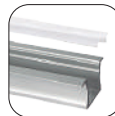

**Perfiles**  
Profiles

p.196



**Alimentadores**  
Power supplies

p.211



**Conector tira COB-tira**  
COB strip-COB strip connector

CONAC-B03B-KIT



**Controladores**  
Controllers

p.202



2700K  
3000K 4000K

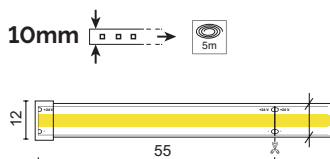
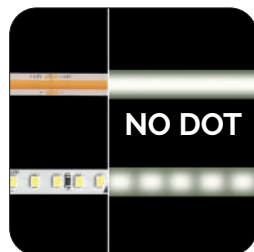

**2700K**  
10W/m 880lm/m.

202DC-L3810FC0-00

**3000K**  
10W/m 930lm/m

202DC-L3910FC0-00

**4000K**  
10W/m 980lm/m

202DC-L4010FC0-00



**2700K**  
14W/m 1225lm/m

202DC-L3814FC0-00

**3000K**  
14W/m 1290lm/m

202DC-L3914FC0-00

**4000K**  
14W/m 1360lm/m

202DC-L4014FC0-00

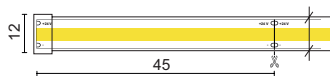

**Alimentadores  
Power supplies**

p.211



Recomendaciones de uso e instalación / Recommendations for use and installation (p.804)

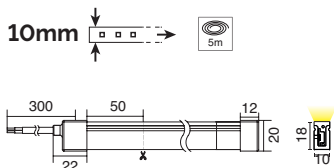

**2700K**  
12.7W/m 505lm/m

**3000K**  
12.7W/m 515lm/m

**4000K**  
12.7W/m 540lm/m

205CN-L3012FCO-00

205CN-L3112FCO-00

205CN-L3312FCO-00

140  
LED/m



**Accesorio**  
**Accessory**

TAP.SET.IP65.SENA205CN



*2 grapas de fijación/m incluidas*  
*2 fixing clips/m included*

**Grapas extra / Extra staples**

GRA\_205CN

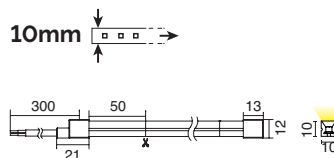
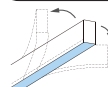

**2700K**  
12.7W/m 950lm/m

**3000K**  
12.7W/m 960lm/m

**4000K**  
12.7W/m 1020lm/m

207CN-L3012FCO-00

207CN-L3112FCO-00

207CN-L3312FCO-00

140  
LED/m



**Accesorio**  
**Accessory**

TAP.SET.IP65.SENA207CN



*2 grapas de fijación/m incluidas*  
*2 fixing clips/m included*

**Grapas extra / Extra staples**

GRA\_207CN



**Alimentadores**  
**Power supplies**

p.211



Recomendaciones de uso e instalación / Recommendations for use and installation (p.804)



# SENA RGB

IP 65

LED STRIP

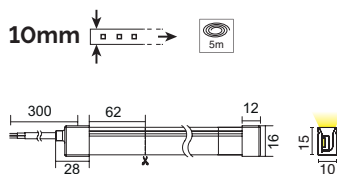

14,4W/m ● 50lm ● 150lm ● 35lm

205CN-L0414FC0-00

98 LED/m



Accesorio  
Accessory

TAP.SET.IP65.SENARGB



2 grapas de fijación/m incluidas  
2 fixing clips/m included

Grapas extra / Extra staples

GRA\_205CN

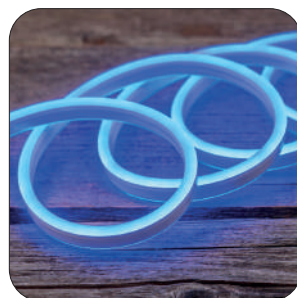
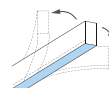

Alimentadores  
Power supplies

p.211



Recomendaciones de uso e instalación / Recommendations for use and installation (p.804)

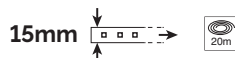
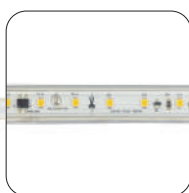

220V  
240V  
AC DIRECTO A RED  
MAINS VOLTAGE

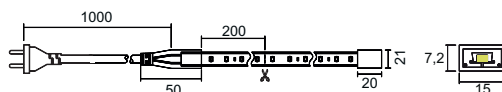

**2700K**

12W/m 1425lm/m

204CH-L3013BCO-00

**3000K**

12W/m 1475lm/m

204CH-L3113BCO-00

**4000K**

12W/m 1505lm/m

204CH-L3313BCO-00



Accesorio  
Accessory

CAB.SET.13.VOLGA

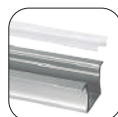

Perfiles  
Profiles

p.196



2700K

3000K

4000K



Recomendaciones de uso e instalación / Recommendations for use and installation (p.804)



12mm 20m

220V 240V AC DIRECTO A RED MAINS VOLTAGE

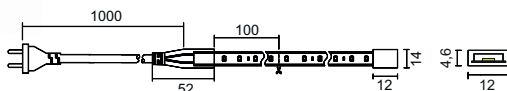

### 2700K

18W/m 1940lm/m

204CH-L3017BCO-00

### 3000K

18W/m 2070lm/m

204CH-L3117BCO-00

### 4000K

18W/m 2150lm/m

204CH-L3317BCO-00

140 LED/m



Accesorio  
Accessory

CAB.SET.19.VOLGA

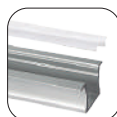

Perfiles  
Profiles

p.196



2700K 3000K 4000K

Recomendaciones de uso e instalación / Recommendations for use and installation (p.804)

# PERFILES / PROFILES

LED STRIP



Superficie / Surface



Perfil (3m)  
Profile (3m)



A50A-778-39

ALU

Difusor opal (3m)  
Opal diffuser (3m)



A50C-778-00

PC  
OPAL

Difusor transparente (3m)  
Transparent diffuser (3m)



A50D-778-00

PC  
TRANS

Tapa final  
End cap



A50G-778-03

Tapa final con agujero  
End cap with hole



A50H-778-03

Grapas  
Staples

A50I-778-00

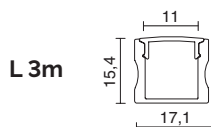

Perfil (3m)  
Profile (3m)



A63A-778-39

ALU

Difusor opal (3m)  
Opal diffuser (3m)



A63C-778-00

PC  
OPAL

Difusor transparente (3m)  
Transparent diffuser (3m)



A63D-778-00

PC  
TRANS

Tapa final  
End cap



A63G-778-03

Tapa final con agujero  
End cap with hole



A63H-778-03

Grapas  
Staples

A63I-778-00

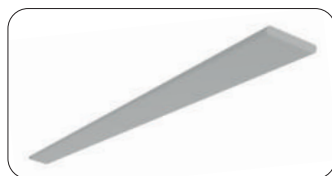

Perfil (3m)  
Profile (3m)

A67A-778-39



Acabado gris o aluminio anodizado / Grey or anodised aluminium finish

Recomendaciones de uso e instalación / Recommendations for use and installation (p.804)

# PERFILES / PROFILES

LED STRIP



Superficie / Surface

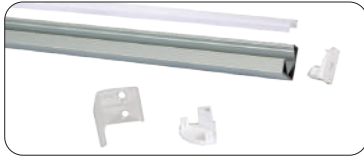

L 3m

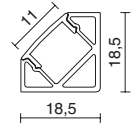

Perfil (3m)  
Profile (3m)



Difusor opal (3m)  
Opal diffuser (3m)



Difusor transparente (3m)  
Transparent diffuser (3m)



A52A-778-39

ALU

A50C-778-00

PC  
OPAL

A50D-778-00

PC  
TRANS

Tapa final  
End cap



Tapa final con agujero  
End cap with hole



Grapas  
Staples

A52G-778-03

A52H-778-03

A52I-778-00



L 3m

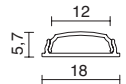

Perfil (3m)  
Profile (3m)



Difusor opal (3m)  
Opal diffuser (3m)



Difusor transparente (3m)  
Transparent diffuser (3m)



A66A-778-39

ALU

A66C-778-00

PC  
OPAL

A66D-778-00

PC  
TRANS

Tapa final  
End cap



Tapa final con agujero  
End cap with hole



Grapas  
Staples

A66G-778-03

A66H-778-03

A66I-778-00



L 3m

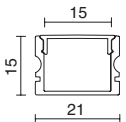

Perfil (3m)  
Profile (3m)



Difusor opal (3m)  
Opal diffuser (3m)



Difusor transparente (3m)  
Transparent diffuser (3m)



A71A-778-39

ALU

A71C-778-00

PC  
OPAL

A71D-778-00

PC  
TRANS

Tapa final  
End cap



Tapa final con agujero  
End cap with hole



Grapas  
Staples

A71G-778-03

A71H-778-03

A71I-778-00

Acabado gris o aluminio anodizado / Grey or anodised aluminium finish

Recomendaciones de uso e instalación / Recommendations for use and installation (p.804)

# PERFILES / PROFILES

LED STRIP



Empotrable / Recessed



L 3m

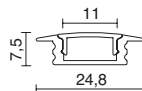

Perfil (3m)  
Profile (3m)



■ A51A-778-39

ALU

Difusor opal (3m)  
Opal diffuser (3m)



A50C-778-00

PC  
OPAL

Difusor transparente (3m)  
Transparent diffuser (3m)



A50D-778-00

PC  
TRANS

Tapa final  
End cap



■ A51G-778-03

Tapa final con agujero  
End cap with hole



■ A51H-778-03

Grapas  
Staples

A51I-778-00



L 3m

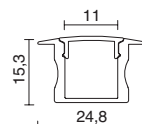

Perfil (3m)  
Profile (3m)



■ A64A-778-39

ALU

Difusor opal (3m)  
Opal diffuser (3m)



A50C-778-00

PC  
OPAL

Difusor transparente (3m)  
Transparent diffuser (3m)



A50D-778-00

PC  
TRANS

Tapa final  
End cap



■ A64G-778-03

Tapa final con agujero  
End cap with hole



■ A64H-778-03

Grapas  
Staples

A64I-778-00

Acabado gris o aluminio anodizado / Grey or anodised aluminium finish

Recomendaciones de uso e instalación / Recommendations for use and installation (p.804)

# PERFILES / PROFILES

LED STRIP



Empotrable / Recessed



L 3m

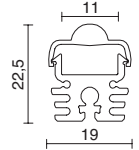

Perfil (3m)  
Profile (3m)



A68A-778-39

ALU

Difusor 30° (3m)  
30° diffuser (3m)



A68C-778-00

PC  
OPAL

Difusor 60° (3m)  
60° diffuser (3m)



A68D-778-00

PC  
TRANS

Tapa final  
End cap



A68G-778-03

Tapa final con agujero  
End cap with hole



A68H-778-03

Grapas  
Staples

A68I-778-00



L 3m

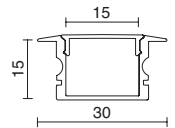

Perfil (3m)  
Profile (3m)

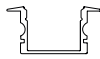

A72A-778-39

ALU

Difusor opal (3m)  
Opal diffuser (3m)



A71C-778-00

PC  
OPAL

Difusor transparente (3m)  
Transparent diffuser (3m)



A71D-778-00

PC  
TRANS

Tapa final  
End cap



A72G-778-03

Tapa final con agujero  
End cap with hole



A72H-778-03

Grapas  
Staples



A72I-778-00

Acabado gris o aluminio anodizado / Grey or anodised aluminium finish

Recomendaciones de uso e instalación / Recommendations for use and installation (p.804)

# PERFILES / PROFILES

LED STRIP



Suspensión / pendant



L 3m

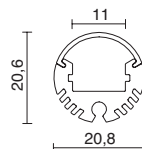

Perfil (3m)  
Profile (3m)



A69A-778-39

ALU

Difusor opal (3m)  
Opal diffuser (3m)



A69C-778-00

PC  
OPAL

Difusor transparente (3m)  
Transparent diffuser (3m)



A69D-778-00

PC  
TRANS

Tapa final  
End cap



A69G-778-03

Tapa final con agujero  
End cap with hole



A69H-778-03

Soporte armario  
Wardrobe support



A69I-778-00

Accesorio de suspensión (altura máxima 3m)  
Suspension accessory (maximum height 3m)



Recomendación: 1 unidad/metro  
Recommendation: 1 unit/meter

A69J-778-00

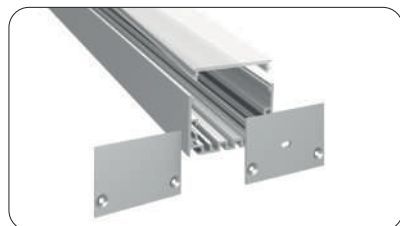

L 3m

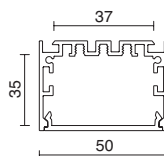

Perfil (3m)  
Profile (3m)

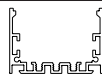

A70A-778-39

ALU

Difusor opal (3m)  
Opal diffuser (3m)



A70C-778-00

PC  
OPAL

Difusor transparente (3m)  
Transparent diffuser (3m)



A70D-778-00

PC  
TRANS

Tapa final  
End cap

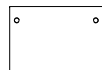

A70G-778-03

Tapa final con agujero  
End cap with hole



A70H-778-03



Accesorio de suspensión (altura máxima 3m)  
Suspension accessory (maximum height 3m)

A69J-778-00

Recomendación: 1 unidad/metro  
Recommendation: 1 unit/meter

Acabado gris o aluminio anodizado / Grey or anodised aluminium finish

Recomendaciones de uso e instalación / Recommendations for use and installation (p.804)



# COMPATIBILIDAD TIRA LED CON PERFIL

## LED STRIP COMPATIBILITY WITH PROFILE

		PERFILERIA ALUMINIO / ALUMINUM PROFILING											
		A50	A63	A52	A66	A51	A64	A68	A69	A70	A71	A72	
TIRAS LED / LED STRIPS	IP20	200AS-	●	●	●	●	●	●	●	●	●	●	●
		201AS-	●	●	●	●	●	●	●	●	●	●	●
		202AC	●	●	●	●	●	●	●	●	●	●	●
		203AS-	●	●	●	●	●	●	●	●	●	●	●
		204AS-	●	●	●	●	●	●	●	●	●	●	●
		206AS-	●	●	●	●	●	●	●	●	●	●	●
	IP67	200DS-									●	●	●
		201DS-									●	●	●
		202DS-									●	●	●
		203DS-	●	●	●	●	●	●	●	●	●	●	●
		204DS-										●	●
	IP65	204CH	<i>No requiere perfilera de aluminio</i> <i>Does not require aluminum profiles</i>										
205CN-													
207CN-													

Servicio de corte y soldadura, consultar con departamento de ventas.  
 Cutting and welding service, consult with sales department.

# CONTROL REMOTO DE RADIOFRECUENCIA RADIO FREQUENCY REMOTE CONTROL

LED STRIP



**Panel Táctil universal DMX / DMX universal Touch Panel** (86 x 86 x 36mm)

CONTT15

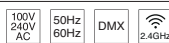

cableado  
wiring

- Diferentes tipos de controladores Monocolor, RGB, RGBW, etc. con un solo panel.
- Control cromático táctil.
- Distancia de 10 m.
- Capacidad de control en 4 zonas.

- Different types of controllers Monocolor, RGB, RGBW, etc. with a single panel.
- Touch color control.
- Distance of 10 m.
- Control capacity in 4 zones.



**Mando Universal / Universal remote control** (140 x 60 x 26mm)

CONTRT10



- Diferentes tipos de controladores Monocolor, RGB, RGBW, etc. con un solo mando.
- Control cromático táctil.
- Capacidad de control en 4 zonas diferentes con el mismo o diferente tipo de controlador en cada zona.
- Posibilidad de configurar cada zona.
- Distancia de 30 m.
- Working Voltage: 3Vdc (2xAAA no included).

- Different types of controllers Monocolor, RGB, RGBW, etc. with a single remote control.
- Touch color control.
- Control capacity in 4 different zones with the same or different type of controller in each zone.
- Possibility of configuring each zone.
- Distance of 30 m.
- Working Voltage: 3Vdc (2xAAA not included).

# CONTROLADORES REMOTOS REMOTE CONTROLLERS

LED STRIP



## Controlador Monocolor Monocolor Controller

(97 x 33 x 18 mm)

CONT.V1



Control: RF 2.4GHz or PUSH Dim  
IN: 5-36Vdc  
OUT: 5-36Vdc  
Output Current: 1 Channels / 8A (per channel)  
Output Power: 192W (24V)



## Controlador doble color (blanco tunable) Dual color controller (tunable white)

(175 x 45 x 27 mm)

CONT.V2-L



Control: RF 2.4GHz or PUSH Dim  
IN: 5-36Vdc  
OUT: 5-36Vdc  
Output Current: 1 Channels / 8A (per channel)  
Output Power: 192W (24V)

- Encendido y regulación suavizados sin parpadeo.
- Cada controlador acepta hasta 10 mandos universales.
- Con un solo mando se pueden regular ilimitados controladores.
- Función de autotransmisión: un controlador puede repetir la señal a otro controlador ubicado hasta 15m, concatenando hasta 100m.
- Verifique la corriente de salida para dimensionar la longitud y la potencia de las tiras LED asociadas.
- Regulación con memoria.
- Distancia: 30m (desde el mando al controlador directamente).

- Flicker-free switching on and regulation smoothed.
- Each controller accepts up to 10 universal remote controllers.
- Unlimited controllers can be regulated with a single remote control.
- Autotransmission function: one controller can repeat the signal to another controller located up to 15m, concatenating up to 100m.
- Check the output current to size the length and power of the associated LED strips.
- Regulation with memory.
- Distance: 30m (from remote control to head controller directly).

# CONTROLADORES REMOTOS REMOTE CONTROLLERS

LED STRIP



## Controlador RGB/RGBW RGB / RGBW controller

(175 x 45 x 27 mm)

CONT.V4



Control: RF 2.4GHz or PUSH Dim  
IN: 12-48Vdc  
OUT: 4x (12-48Vdc)  
Output Current: 4 Channels / 5A (per channel)  
Output Power: 4x (120W (24V))

- Controlador adecuado para tiras LED RGB y RGBW.
- Encendido y regulación suavizados sin parpadeo.
- Pulsador puede controlar el encendido/apagado y la regulación; así como gestionar hasta 8 escenas.
- Con cada controlador acepta hasta 10 mandos universales.
- Puede, también, utilizarse como regulador de doble color o monocolor con buena compatibilidad.
- Función de auto transmisión: se puede repetir la señal a otro controlador hasta 15m, concatenando hasta 100m.
- Auto sincronizado: diferentes controladores pueden regularse a la vez cuanto están asociados al mismo mando, con el mismo modo dinámico y velocidad.
- Verifique la corriente de salida para dimensionar la longitud y la potencia de las tiras LED asociadas.
- Regulación con memoria.
- Distancia: 30 m (desde el control remoto al controlador directamente).

- Controller suitable for RGB and RGBW LED strips.
- Flicker-free switching on and regulation smoothed.
- Push button can control on / off and regulation; as well as managing up to 8 scenes.
- With each controller accepts up to 10 universal remote controllers.
- It can also be used as a double or single color regulator with good compatibility.
- Auto transmission function: the signal can be repeated to another controller up to 15m, concatenating up to 100m.
- Synchronized auto: different controllers can be regulated at the same time when they are associated with the same command, with the same dynamic mode and speed.
- Check the output current to size the length and power of the associated LED strips.
- Regulation with memory.
- Distance: 30m (from remote control to controller directly).

# CONTROLADORES REMOTOS REMOTE CONTROLLERS

LED STRIP



## Controlador RGB + Doble Color (Blanco Tuneable) RGB + Dual Color Controller (Tunable White)

(170 x 50 x 23 mm)

CONT.V5



Control: RF 2.4GHz  
IN: 12-48Vdc or PUSH DIM  
OUT: 5x (12-48Vdc)  
Output Current: 5 Channels / 4A (per channel)  
Distance: 30m  
Output Power: 5x (120W (24V))

- Controlador adecuado para tiras LED RGB+CCT (RGB y doble color en la misma tira).
- Posibilidad de configurar uso conjunto de RGB + CCT o separado.
- Puede utilizarse, también, como regulador monocolor con buena compatibilidad.
- Verifique la corriente de salida para dimensionar la longitud y la potencia de las tiras LED asociadas.
- Cada controlador acepta hasta 10 mandos universales.
- Regulación con memoria.
- Distancia: 30 m (desde el control remoto al controlador directamente).

- Controller suitable for RGB + CCT LED strips (RGB and double color on the same strip).
- Possibility of configuring joint use of RGB + CCT or separately.
- It can also be used as a single color regulator with good compatibility.
- Check the output current to size the length and power of the associated LED strips.
- Each controller accepts up to 10 universal remote controllers.
- Regulation with memory.
- Distance: 30m (from remote control to controller directly).

# CONTROLADORES REMOTOS REMOTE CONTROLLERS

LED STRIP



**Controlador RGB/RGBW IP67**  
**RGB / RGBW controller IP67**

(175 x 45 x 27 mm)

CONT.V4WP



Control: RF 2.4GHz or PUSH Switch  
IN: 12-36Vdc  
OUT: 4x (12-36Vdc)  
Output Current: 4 Channels / 5A (per channel)  
Output Power: 4x (120W (24V))

- Encendido y regulación suavizados sin parpadeo para aplicaciones de exterior.
- Conectado a un pulsador puede controlar el encendido/apagado y la regulación; así como gestionar hasta 8 escenas
- Cada controlador acepta hasta 10 mandos universales
- Puede, también, utilizarse como regulador de doble color o monocolor con buena compatibilidad.
- Función de auto transmisión y Auto sincronizado.
- Verifique la corriente de salida para dimensionar la longitud y la potencia de las tiras LED asociadas.
- Regulación con memoria.
- Distancia: 30 m (desde el control remoto al controlador directamente).

- Flicker-free smoothed on and dimming for outdoor applications.
- Connected to a push button it can control the on / off and regulation; as well as manage up to 8 scenes
- Each controller accepts up to 10 universal remote controllers.
- It can also be used as a double or single color regulator with good compatibility.
- Auto transmission function and Auto synchronized.
- Check the output current to size the length and power of the associated LED strips.
- Regulation with memory.
- Distance: 30m (from remote control to controller directly).



**Controlador bluetooth (CASAMBI)**  
**Bluetooth controller (CASAMBI)**

(72,6 x 30 x 18 mm)

CONT.CBU-PWM4



Control: RF 2.4GHz or PUSH Switch  
IN: 12-36Vdc  
OUT: 12-36Vdc  
Output Current: 4 Channels / 5A (per channel)

- Controlador CBU-PWM4 con 4 canales de salida PWM independientes.
- Configurable para control de blanco, blanco dinámico, RGB ó RGBW.
- Controlar mediante el sistema Bluetooth CASAMBI, que ofrece una APP gratuita descargable desde la Apple Store y Google Play que permite crear escenas, grupos, animaciones de una forma intuitiva y rápida.

- CBU-PWM4 controller with 4 independent PWM output channels.
- Configurable to control white, dynamic white, RGB or RGBW.
- Control through the CASAMBI Bluetooth system, which offers a free APP downloadable from the Apple Store and Google Play that allows you to create scenes, groups, animations in an intuitive and fast way.

# CONTROLADORES REMOTOS POR VOZ Y/O WIFI REMOTE CONTROLLERS BY VOICE AND/OR WIFI

LED STRIP



## Controlador Maestro 2 en 1 con función Pulsador 2-in-1 Master Controller with Push Button function.

(114 x 38 x 20 mm)

CONT:WT1



Control: VOZ (Echo o Google Assitant)  
APP Tuya // RF y WIFI // PUSH  
Input Voltage: 12-36Vdc  
Output Voltage: 2 x (12-36)Vdc  
Output Current: 5A / channel

- Controlador Maestro 2 en 1 para control de tiras LED Monocolor y CCT (doble color).
- Puede funcionar como convertidor WiFi-RF para, en función maestro, poder controlar diferentes dispositivos, de igual tipo de luz, mediante VOZ, APP Tuya y PUSH.
- Control, mediante APP Tuya, de ON/OFF, brillo y Temperatura de color (CCT) de encendidos programados, escenas, control en remoto.
- Control por VOZ, gracias a Tuya, a través de Amazon ECHO (ALEXA) o Google Asisstant.
- Configuración sencilla por medio de pulsaciones.

- 2-in-1 Master Controller to control Monocolor and CCT (double color) LED strips.
- It can function as a WiFi-RF converter to control different devices, of the same type of light, in a master function, through VOICE, Tuya APP and PUSH.
- Control, through APP Tuya, of ON / OFF, brightness and Color Temperature (CCT) of programmed ignitions, scenes, remote control.
- VOICE control, thanks to Tuya, through Amazon ECHO (ALEXA) or Google Assistant.
- Simple configuration by means of keystrokes.

# CONTROLADORES REMOTOS POR VOZ Y/O WIFI REMOTE CONTROLLERS BY VOICE AND/OR WIFI

LED STRIP



**Controlador Maestro 5 en 1 - WIFI (TUYA) . Compatible ALEXA.  
5 in 1 Master Controller - WIFI (TUYA). ALEXA compatible.**

(114 x 38 x 20 mm)

CONT.WT5



Control: VOICE (Echo o Google Assitant)  
APP Tuya // RF y WIFI  
Input Voltage: 12-24Vdc  
Output Voltage: 5 x (12-24)Vdc  
Output Current: 3A / channel

- Controlador Maestro 5 en 1 para control de tiras LED Monocolor, CCT, RGB, RGBW y RGB + CCT.
- Puede funcionar como convertidor WiFi-RF para, en función maestro, poder controlar diferentes dispositivos, de igual tipo de luz, mediante VOZ y APP Tuya.
- Control, mediante APP Tuya, de ON/OFF, brillo, CCT, RGB/RGBW, RGB + CCT, encendidos programados, escenas, control en remoto.
- Control por VOZ, gracias a Tuya, a través de Amazon ECHO (ALEXA) o Google Assistant.
- Configuración sencilla por medio de pulsaciones.

- 5 in 1 Master Controller to control Monocolor, CCT, RGB, RGBW and RGB + CCT LED strips.
- It can function as a WiFi-RF converter for, as a master, to be able to control different devices, of the same type of light, through VOICE and Tuya APP
- Control, through APP Tuya, of ON / OFF, brightness, CCT, RGB / RGBW, RGB + CCT, programmed ignitions, scenes, remote control
- VOICE control, thanks to Tuya, through Amazon ECHO (ALEXA) or Google Assistant.
- Simple configuration by means of keystrokes.



# CONTROLADORES REMOTOS POR VOZ Y/O WIFI REMOTE CONTROLLERS BY VOICE AND/OR WIFI

LED STRIP



Tuya APP control cloud  
Tuya APP cloud control

(52 x 52 x 26 mm)

CONT.L1WT



Control: APP Tuya // RF // PUSH Dim  
Input Voltage: 100-240Vac  
Output signal: 0/1-10V (20mA)  
Output Current: 5A / channel

- Salida de 1 canal de señal 0 / 1-10V, conectar con driver regulable 0 / 1-10V.
- Control mediante Tuya APP, encendido / apagado, ajuste de brillo, retardo de encendido / apagado de luz, temporizador, función de escena, control de voz, compatible con Amazon ECHO.
- Salida de 0-10 V seleccionable mediante interruptor DIP, 256 niveles 0-100% de atenuación suave sin flash.
- Compatibilidad con control remoto de atenuación de zona única o zona múltiple RF 2.4G.
- Puede funcionar como convertidor WiFi-RF, luego use la APLICACIÓN Tuya para controlar uno o más controladores LED de atenuación de RF o controladores sincrónicamente.
- Conecte con un interruptor de empuje externo para lograr la función de atenuación de encendido / apagado y 0-100%.
- Fácil de colocar en una caja de conexiones de pared estándar detrás de un interruptor.

- 1 channel 0 / 1-10V signal output, connect with 0 / 1-10V dimmable driver.
- Control by Tuya APP, on / off, brightness adjustment, light on / off delay, timer, scene function, voice control, compatible with Amazon ECHO.
- Selectable 0-10V output via DIP switch, 256 levels 0-100% smooth dimming without flash.
- Support for 2.4G RF single zone or multi zone dimming remote control.
- It can work as a WiFi-RF converter, then use the Tuya APP to control one or more RF dimming LED drivers or drivers synchronously.
- Connect with external push switch to achieve on / off and 0-100% dimming function.
- Easy to fit in a standard wall junction box behind a switch.

# CONTROLADORES REMOTOS DALI

## DALI REMOTE CONTROLLER

LED STRIP



**DALI Dimmer**  
(175 x 45 x 27 mm)

CONT.DA1

Input Voltage: 12-48VDC  
Input signal: DALI+Push dim  
Output Current:  
1channel, 15A  
Output Power:  
180W (12V) / 360W ( 24V)



**DALI Dimmer**  
(175 x 45 x 27 mm)

CONT.DA4



Input Voltage: 12-48VDC  
Input signal: DALI+Push dim  
Output Current:  
1channel, 15A  
Output Power:  
180W (12V) / 360W ( 24V)



**1AC Triac DALI Dimmer**  
(175 x 45 x 27 mm)

CONT.DT



Input Voltage: 100-240Vac  
Input signal:  
DALI + Push dim + Corte Fas.  
Output Current: Max 1.5A  
Output Power: 150-360W

## AMPLIFICADORES

### AMPLIFIERS

*Acondiciona la señal a lo largo del tramo de tira LED, posibilitando que la intensidad que pasa por la tira siga estable y sin ninguna caída en la totalidad de su longitud.*

*It conditions the signal along the length of the LED strip, making it possible for the intensity that passes through the strip to remain stable and without any drop over its entire length.*



**Amplificador 1 canal**  
**1 channel amplifier** (97x33x18 mm)

CONTEV1-S

Input Voltage: 12-24VDC  
Output Current: 1channel, 15A  
Output Power:  
12V<180W, 24V<360W



**Amplificador 4 canales**  
**4-channel amplifier** (175x45x27 mm)

CONTEV4

Input Voltage: 12-36VDC  
Output Current: 4channel, 5A/canal  
Output Power:  
4x 60W (12V), 4x 120W 24V, 4x 180W (36V)

# ALIMENTADORES POWER SUPPLIES

LED STRIP

IP  
20



**35W** (84 x 57 x 29,5 mm)

B02Q-X3335F-00



**96W** (200,5 x 69,5 x 35 mm)

B02Q-X3396F-00

90V  
264V  
AC

24V

IP  
20

**MW**  
MEAN WELL



**75W** (180 x 52 x 30 mm)

B02C-X3375F-00

**30W** (153x41x32 mm)

B02C-X3330F-00

**60W** (180 x 52 x 30 mm)

B02C-X3360F-00

24V

220V  
240V  
AC

IP  
20

**VSS**  
VOSSLÖH  
SCHWABE

**120W** (300 x 40 x 30 mm)

B02C-X33A3F-00

**180W** (345 x 50 x 35 mm)

B02V-X33J5F-00



**40W** (187 x 45 x 31 mm)

**N** B02L-X3340F-00

**150W** (290 x 45 x 31 mm)

**N** B02L-X33A4F-00

**80W** (290 x 45 x 31 mm)

**N** B02L-X3380F-00

**250W** (431 x 45 x 31 mm)

**N** B02L-X33A6F-00

220V  
240V  
AC

24V

IP  
20

**DALI**

PUSH

**VSS**  
VOSSLÖH  
SCHWABE

IP  
67



**35W** (148 x 40 x 30 mm)

B02R-X3335F-00

**100W** (191 x 63 x 37,5 mm)

B02R-X33A1F-01

**60W** (162,5 x 42,5 x 32 mm)

B02R-X3360F-00

**150W** (191 x 63 x 37,5 mm)

B02R-X33A4F-00

90V  
264V  
AC

24V

IP  
67

**MW**  
MEAN WELL



**60W** (150 x 53 x 35 mm)

B02H-X3360F-00

**120W** (190 x 52 x 37 mm)

B02H-X33A3F-00

**90W** (171 x 63 x 37,5 mm)

B02H-X3390F-00

**200W** (195 x 68 x 39,5 mm)

B02H-X33A5F-00

90V  
264V  
AC

24V

IP  
67

**DALI**

**MW**  
MEAN WELL



**100W** (206 x 69 x 37 mm)

B02Y-X33A1F-00

**150W** (206 x 69 x 37 mm)

B02Y-X33A4F-00

**75W** (155 x 49 x 32 mm)

B02Y-X3375F-00

**250W** (258 x 86 x 47 mm)

B02Y-X33A6F-00

220V  
240V  
AC

24V

IP  
67

**VSS**  
VOSSLÖH  
SCHWABE

# FAST MOVERS



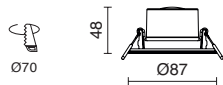

LED SMD AC 6,5W

□ 1036A-L4107BA0-01



K SELECT	2700K	570lm
	3000K	630lm
	4000K	630lm

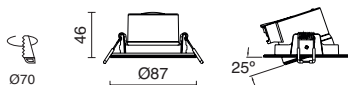

LED SMD AC 4,8W

□ 1036B-L4105B30-01



K SELECT	2700K	470lm
	3000K	500lm
	4000K	500lm



Acabado blanco / White finish





1036C-



LED SMD AC 10.5W

□ 1036C-L4109BAC-01

K SELECT	2700K	850lm
	3000K	1000lm
	4000K	950lm



1036E-



LED SMD AC 8W

■ □ 1036E-L4108BAZ-01

K SELECT	2700K	650lm
	3000K	700lm
	4000K	700lm



Ø85

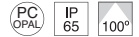
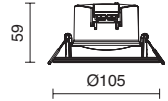

LED SMD AC 9W

□ 1036D-L4109B3C-01



Ø85

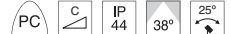
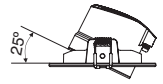
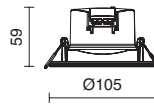

K SELECT	2700K	720lm
	3000K	850lm
	4000K	800lm



Acabado blanco / White finish

Aro decorativo / Decorative ring



■ A13C-1036-02





**ORIENTABLE**

□ D01A-823-01

□ D01B-823-01  
■ D01B-823-02

□ D01C-823-01  
■ D01C-823-02

□ D01D-823-01  
■ D01D-823-02



**FIXED**

□ D01E-823-01

□ D01F-823-01  
■ D01F-823-02

□ D01G-823-01  
■ D01G-823-02

□ D01H-823-01  
■ D01H-823-02

# NOK 2

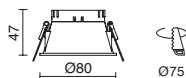

**SYMETRIC**

□ D02E-824-01

□ D02F-824-01

□ D02G-824-01

□ D02H-824-01  
■ D02H-824-02



Acabado blanco o negro / White or black finish

Accesorio necesario / Necessary accessory





# NOK 3

FAST MOVERS



## SYMETRIC

D03E-826-01

D03F-826-01

D03G-826-01

D03H-826-01

D03H-826-02

# NOK 4

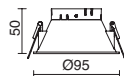

## SYMETRIC

D04E-827-01

D04F-827-01

D04G-827-01

D04H-827-01

D04H-827-02

ALU + PC



Acabado blanco o negro / White or black finish

Accesorio necesario / Necessary accessory



## Embellecedor / Embellisher



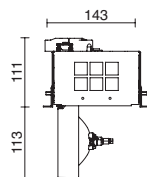

G53 LED AR111 12V / QR-LP 111 75W max.

- 738F-G18RCB-01
- 738F-G18RCB-02
- 738F-G18RCB-03

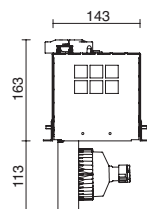

GU10 LED AR111 230V 15W max.

- 738F-G21X1B-01
- 738F-G21X1B-02
- 738F-G21X1B-03



Acabado blanco, negro o gris / White, black or grey finish

Filtros de conversión para pescado, marisco, verdura, carne o pan  
Conversion for fish, seafood, vegetables, meat or bread

	SEAFOOD	A14A-738-00	for 3000K
	VEG+FRUIT	A14A-738-00	
			for 4000K
	FISH	A14A-738-00	
	MEAT	A14B-738-00	
	BREAD	A14C-738-00	

Porta filtros / Support for filters

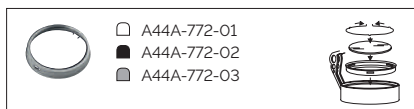

Marcos / Frames

	<ul style="list-style-type: none"> <li>□ A45A-738-01</li> <li>■ A45A-738-02</li> <li>■ A45A-738-03</li> </ul>			152x152
	<ul style="list-style-type: none"> <li>□ A45B-738-01</li> <li>■ A45B-738-02</li> <li>■ A45B-738-03</li> </ul>			300x152
	<ul style="list-style-type: none"> <li>□ A45C-738-01</li> <li>■ A45C-738-02</li> <li>■ A45C-738-03</li> </ul>			450x152
	<ul style="list-style-type: none"> <li>□ A45D-738-01</li> <li>■ A45D-738-02</li> <li>■ A45D-738-03</li> </ul>			600x152
	<ul style="list-style-type: none"> <li>□ A45E-738-01</li> <li>■ A45E-738-02</li> <li>■ A45E-738-03</li> </ul>			300x300

ACER

Acabado blanco, negro o gris / White, black or grey finish

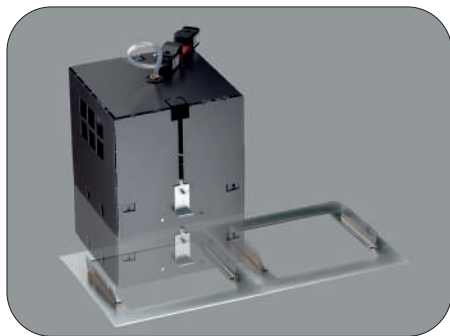

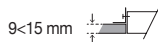
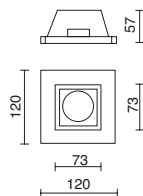

GU10 Led Retrofit/QPAR-16 230V 50W

□ 798A-G21X1B-01

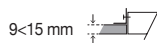
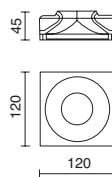

GU10 Led Retrofit/QPAR-16 230V 50W

□ 798B-G21X1B-01

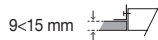
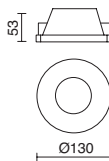

GU10 Led Retrofit/QPAR-16 230V 50W

□ 798C-G21X1B-01



Acabado blanco / White finish

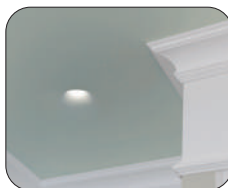

Accesorio necesario / Necessary accessory

Para techo de yeso / For plaster ceiling

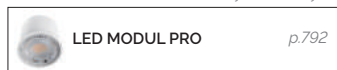

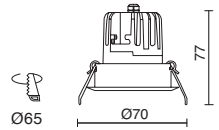

LED COB 4,5W 470lm 3000K

□ 816A-L3106B-01



Acabado blanco / White finish

Con Driver remoto  
With Remote Driver

# JANO

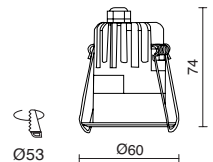

LED COB 6,5W 675lm 3000K

□ 818B-L3108B-01

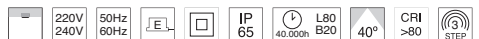

Acabado blanco / White finish

Con Driver remoto  
With Remote Driver



## GU10

LED Retrofit / QPAR-16 230V 50W max.

- 750A-G42X1B-01
- 750A-G42X1B-02
- 750A-G42X1B-30
- 750A-G42X1B-32
- 750A-G42X1B-45
- 750A-G42X1B-48



## GU5.3

LED Retrofit / QR-CBC 51 12V 50W max.

- 750A-G23X1D-01
- 750A-G23X1D-02
- 750A-G23X1D-30
- 750A-G23X1D-32
- 750A-G23X1D-45
- 750A-G23X1D-48

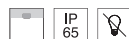
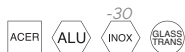

Acabado blanco, negro, inox, cromado, cromado mate o níquel mate  
White, black, stainless steel, chrome, matt chrome or matt nickel finish

Accesorio necesario / Necessary accessory

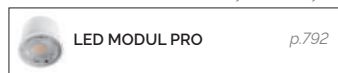

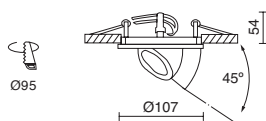

## GU10

LED Retrofit / QPAR-16 50W max.

- 741A-G42X1B-01
- 741A-G42X1B-02
- 741A-G42X1B-03
- 741A-G42X1B-32
- 741A-G42X1B-45
- 741A-G42X1B-48



## GU5.3

LED Retrofit / QR-CBC 51 50W max.

- 741A-G23X1D-01
- 741A-G23X1D-02
- 741A-G23X1D-03
- 741A-G23X1D-32
- 741A-G23X1D-45
- 741A-G23X1D-48



Acabado blanco, negro, gris, cromado, cromado mate o níquel mate  
White, black, grey, chrome, matt chrome or matt nickel finish

Accesorio necesario / Necessary accessory





780A-



780B-

**GU10**

LED Retrofit / QPAR-16 230V 50W max.

- 780A-G42X1B-21
- 780A-G42X1B-02
- 780A-G42X1B-45
- 780A-G42X1B-48

**GU5.3**

LED Retrofit / QR-CBC 51 12V 50W max.

- 780A-G23X1D-21
- 780A-G23X1D-02
- 780A-G23X1D-45
- 780A-G23X1D-48

- 780B-G42X1B-21
- 780B-G42X1B-02
- 780B-G42X1B-45
- 780B-G42X1B-48

- 780B-G23X1D-21
- 780B-G23X1D-02
- 780B-G23X1D-45
- 780B-G23X1D-48



Ø65

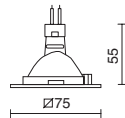
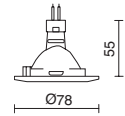

780E-



780F-

**GU10**

LED Retrofit / QPAR-16 230V 50W max.

- 780E-G42X1B-21
- 780E-G42X1B-02
- 780E-G42X1B-45
- 780E-G42X1B-48

**GU5.3**

LED Retrofit / QR-CBC 51 12V 50W max.

- 780E-G23X1D-21
- 780E-G23X1D-02
- 780E-G23X1D-45
- 780E-G23X1D-48

- 780F-G42X1B-21
- 780F-G42X1B-02
- 780F-G42X1B-45
- 780F-G42X1B-48

- 780F-G23X1D-21
- 780F-G23X1D-02
- 780F-G23X1D-45
- 780F-G23X1D-48



Ø75

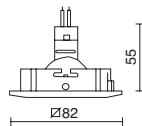
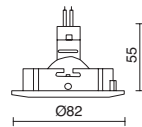

Acabado blanco, negro, cromado mate o níquel mate / White, black, matt chrome or matt nickel finish

Accesorio necesario / Necessary accessory







780C-

LED COB 8W 680lm 3000K

□ 780C-L3108B-21



780D-

LED COB 8W 680lm 3000K

□ 780D-L3108B-21



Ø72

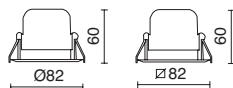

780G-

LED COB 8W 680lm 3000K

□ 780G-L3108B-21



780H-

LED COB 8W 680lm 3000K

□ 780H-L3108B-21



Ø76

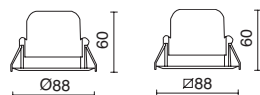

15°

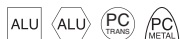
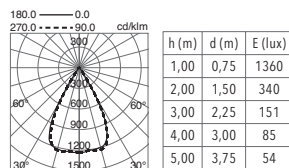

Acabado blanco / White finish

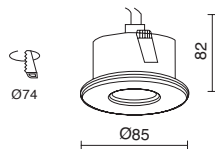

**GU10**  
LED Retrofit / QPAR-16 230V 50W max.

□ 781B-G42X1B-01



**GU5.3**  
LED Retrofit / QR-CBC 51 12V 50W max.

□ 781B-G23X1D-01



Acabado blanco / White finish

# INEL

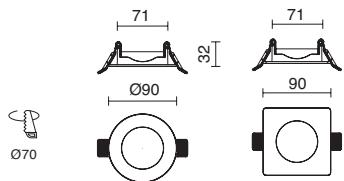

□ A13A-631-01

□ A13B-631-01



□ A13C-631-01

□ A13D-631-01



Acabado blanco / White finish

Accesorio necesario / Necessary accessory



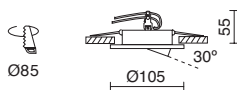

### GU10

LED Retrofit / QPAR-16 230V 50W max.

□ 749B-G42X1B-01



### GU5.3

LED Retrofit / QR-CBC 51 12V 50W max.

□ 749B-G23X1D-01



Acabado blanco / White finish

Lamps p.792

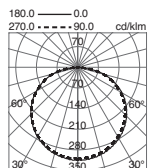

**757B-L3108B**

h (m)	d (m)	E (lux)
1,00	3,78	147
2,00	7,56	37
3,00	11,34	16
4,00	15,12	9
5,00	18,90	6

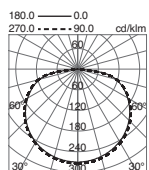

**757C-L3120B**

h (m)	d (m)	E (lux)
1,00	5,48	405
2,00	10,96	101
3,00	16,44	45
4,00	21,92	25
5,00	27,40	16



LED SMD 8W 470lm 3000K

□ 757B-L3108B-01



Ø98

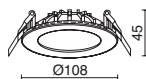

120°



LED SMD 18,5W 1400lm 3000K

□ 757C-L3120B-01



Ø162

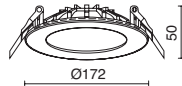

140°



Acabado blanco / White finish

Con Driver remoto  
With Remote Driver



### GU10

LED Retrofit / QPAR-16 230V 50W max.

- 752A-G42X1B-01
- 752A-G42X1B-02
- 752A-G42X1B-03

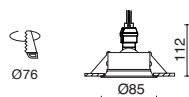

### GU5.3

LED Retrofit / QR-CBC 51 12V 50W max.

- 752A-G23X1D-01
- 752A-G23X1D-02
- 752A-G23X1D-03



Acabado blanco, negro o gris / White, black or grey finish

Accesorio necesario / Necessary accessory

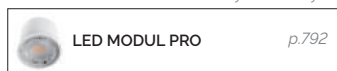

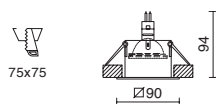

## GU5.3

LED Retrofit / QR-CBC 51 12V 50W max.

- 782A-G23X1D-01
- 782A-G23X1D-03



## GU10

LED Retrofit / QPAR-16 230V 50W max.

- 782A-G42X1B-01
- 782A-G42X1B-03



Acabado blanco o gris / White or grey finish

Accesorio necesario / Necessary accessory





-01



-02



-32



-45



Ø55

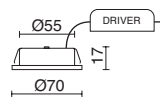

**3000K**  
LED SMD 3,2W 290lm 3000K

- 753A-L3202B-01
- 753A-L3202B-02
- ◐ 753A-L3202B-32
- ◑ 753A-L3202B-45



-01



-02



-32



-45



Ø146

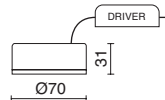

**3000K**  
LED SMD 3,2W 290lm 3000K

- 753B-L3202B-01
- 753B-L3202B-02
- ◐ 753B-L3202B-32
- ◑ 753B-L3202B-45



Acabado blanco, negro, cromado o cromado mate / White, black, chrome or matt chrome finish

Con Driver remoto  
With Remote Driver

Disponibile en 2700K, 4000K, 5000K  
Available in 2700K, 4000K, 5000K

# CALYPSO 2

FAST MOVERS



**3000K**

LED SMD 5W 440lm

□ 979A-L3105A-01

**4000K**

LED SMD 5W 480lm

□ 979A-L3305A-01

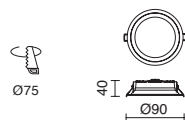

**3000K**

LED SMD 12W 1100lm

□ 979B-L3112A-01

**4000K**

LED SMD 12W 1200lm

□ 979B-L3312A-01

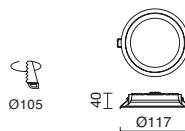

**3000K**

LED SMD 24W 2310lm

□ 979C-L3124A-01

**4000K**

LED SMD 24W 2520lm

□ 979C-L3324A-01

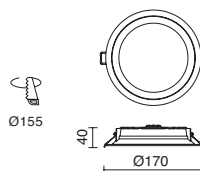

**3000K**

LED SMD 30W 2915lm

□ 979D-L3130A-01

**4000K**

LED SMD 30W 3180lm

□ 979D-L3330A-01

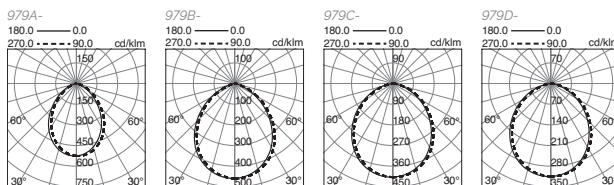
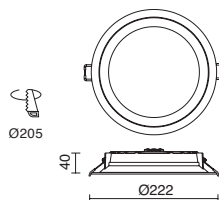

Acabado blanco / White finish

Con Driver remoto  
With Remote Driver



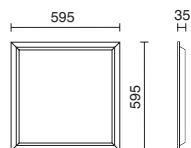

**3000K**  
LED SMD 40W 3400lm

□ 583C-L3140B-01

**4000K**  
LED SMD 40W 3600lm

□ 583C-L3340B-01

*Para falso techo modular.  
For modular ceiling.*

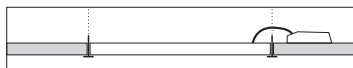

**Kit de superficie  
Surface mounted kit**

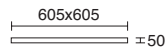

A20B-583-01



Acabado blanco / White finish



*Con Driver remoto  
With Remote Driver*



**3000K**  
LED SMD 6W 420lm

□ 599A-L3106A-01

**4000K**  
LED SMD 6W 480lm

□ 599A-L3306A-01

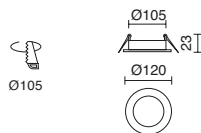

**3000K**  
LED SMD 18W 1535lm

□ 599A-L3118A-01

**4000K**  
LED SMD 18W 1710lm

□ 599A-L3318A-01

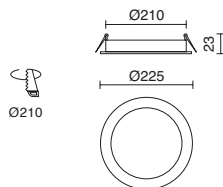

**3000K**  
LED SMD 24W 2040lm

□ 599A-L3124A-01

**4000K**  
LED SMD 24W 2280lm

□ 599A-L3324A-01

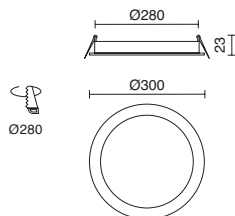

Acabado blanco / White finish

Con Driver remoto  
With Remote Driver



**3000K**  
LED SMD 6W 420lm

□ 599B-L3106A-01

**4000K**  
LED SMD 6W 480lm

□ 599B-L3306A-01

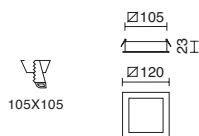

**3000K**  
LED SMD 18W 1535lm

□ 599B-L3118A-01

**4000K**  
LED SMD 18W 1710lm

□ 599B-L3318A-01

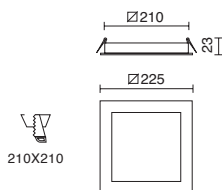

**3000K**  
LED SMD 24W 2040lm

□ 599B-L3124A-01

**4000K**  
LED SMD 24W 2280lm

□ 599B-L3324A-01

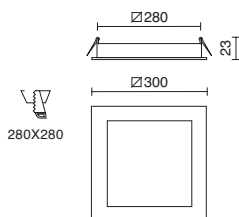

Acabado blanco / White finish

Con Driver remoto  
With Remote Driver



**3000K**  
LED SMD 6W 420lm

□ 599C-L3106A-01

**4000K**  
LED SMD 6W 480lm

□ 599C-L3306A-01



**3000K**  
LED SMD 18W 1535lm

□ 599C-L3118A-01

**4000K**  
LED SMD 18W 1710lm

□ 599C-L3318A-01

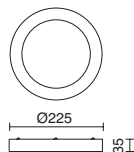

**3000K**  
LED SMD 6W 420lm

□ 599D-L3106A-01

**4000K**  
LED SMD 6W 480lm

□ 599D-L3306A-01



**3000K**  
LED SMD 18W 1535lm

□ 599D-L3118A-01

**4000K**  
LED SMD 18W 1710lm

□ 599D-L3318A-01

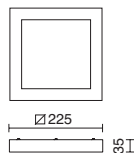

Acabado blanco / White finish

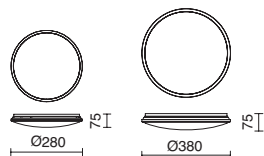

LED SMD 16,5W

LED SMD 27,5W

□ 731B-L4118B-01

□ 731C-L4130B-01

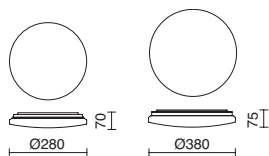

LED SMD 16,5W

LED SMD 27,5W

□ 731D-L4118B-28

□ 731E-L4130B-28



**N** □ 731F-L4118R-28

**N** □ 731G-L4130R-28



K SELECT	16,5W	27,5W
3000K	1870lm	2730lm
4000K	2270lm	3330lm
6000K	2110lm	3090lm

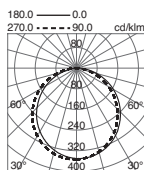
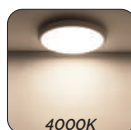
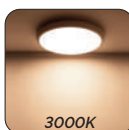

h (m)	d (m)	E (lux)
1,00	3,45	856
2,00	6,90	214
3,00	10,35	95
4,00	13,80	54
5,00	17,25	34

h (m)	d (m)	E (lux)
1,00	3,45	1038
2,00	6,90	260
3,00	10,35	115
4,00	13,80	65
5,00	17,25	42

h (m)	d (m)	E (lux)
1,00	3,45	965
2,00	6,90	241
3,00	10,35	107
4,00	13,80	60
5,00	17,25	39

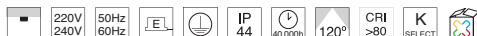

Acabado blanco / White finish





1048A-



1048B-  
1048C-

Suspensión no incluida  
Suspension not included

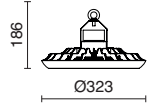
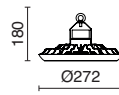

4000K  
LED SMD **100W** 16000lm

□ 1048A-L33RAB-04

LED SMD **150W** 23020lm

□ 1048B-L33RAB-04

LED SMD **200W** 28890lm

□ 1048C-L33RAB-04

6500K  
LED SMD **100W** 16000lm

□ 1048A-L37RAB-04

LED SMD **150W** 23020lm

□ 1048B-L37RAB-04

LED SMD **200W** 28890lm

□ 1048C-L37RAB-04

1048A-

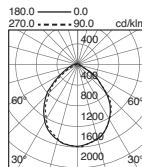

1048B-

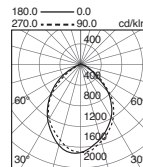

1048C-

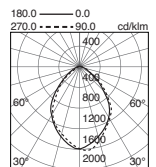

Acabado antracita / Anthracite finish







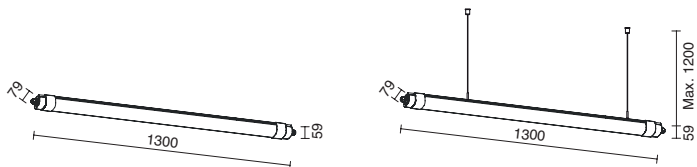

**4000K**  
LED SMD 37W 5850lm

**5700K**  
LED SMD 37W 6150lm

□ 940B-L3340B-01

□ 940B-L3640B-01

□ 940D-L3340B-01

□ 940D-L3640B-01

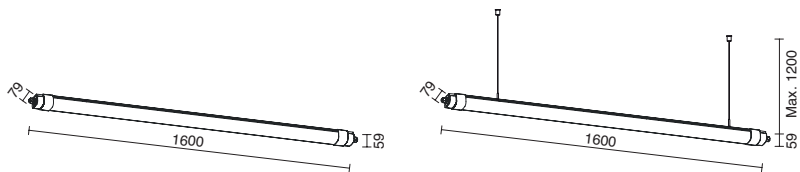

**4000K**  
LED SMD 46W 7550lm

**5700K**  
LED SMD 46W 7850lm

□ 940E-L3350B-01

□ 940E-L3650B-01

□ 940F-L3350B-01

□ 940F-L3650B-01

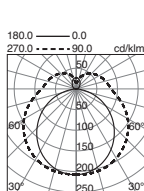

**940B-L3340B**

**940D-L3340B**

h (m)	d (m)	E (lux)
1,00	2,85	936
2,00	5,70	234
3,00	8,55	104
4,00	11,40	59
5,00	14,25	38

**940B-L3640B**

**940D-L3640B**

h (m)	d (m)	E (lux)
1,00	2,85	983
2,00	5,70	246
3,00	8,55	109
4,00	11,40	61
5,00	14,25	39

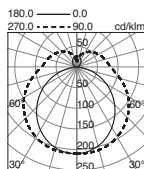

**940E-L3350B**

**940F-L3350B**

h (m)	d (m)	E (lux)
1,00	2,85	1216
2,00	5,70	304
3,00	8,55	135
4,00	11,40	76
5,00	14,25	49

**940E-L3650B**

**940F-L3650B**

h (m)	d (m)	E (lux)
1,00	2,85	1265
2,00	5,70	316
3,00	8,55	141
4,00	11,40	79
5,00	14,25	51



Acabado blanco / White finish



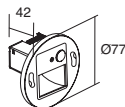

LED SMD 2W

□ 1053A-L4102B90-01



Regulación de:

- Distancia:  $O > 6$  m.
- Tiempo de activación: de 5 seg. a 8 min.
- Ángulo de detección:  $120^\circ$
- Daylight on:  $< 10$  lux

Adjustable:

- Distance:  $O > 6$  m.
- Activation time: from 5 sec. to 8 min.
- Detection angle:  $120^\circ$
- Daylight on:  $< 10$  lux

K SELECT	2700K	148lm
	3200K	154lm
	4000K	168lm



Accesorio necesario / Necessary accessory

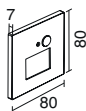

□ A13A-1053A-01

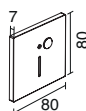

□ A13B-1053A-01



□ A13C-1053A-01



□ A13D-1053A-01

PC (PC)



Acabado blanco / White finish



Cajetín universal redondo para empotrar en hormigón o ladrillo **NO INCLUIDO**.

Universal recessed round box to install in concrete or brick wall **NOT INCLUDED**.

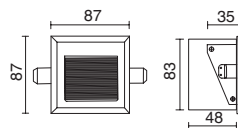

LED CREE 3W 160lm 3000K

□ 726A-LO103B-01

■ 726A-LO103B-39

ALU



Acabado blanco o aluminio anodizado / White or anodized aluminum finish



64X64

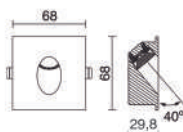

LED CREE 3W 160lm 3000K

□ 706A-LO103B-01

■ 706A-LO103B-39



Ø55

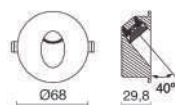

LED CREE 3W 160lm 3000K

□ 706B-LO103B-01

■ 706B-LO103B-39



Acabado blanco o aluminio anodizado / White or anodized aluminum finish



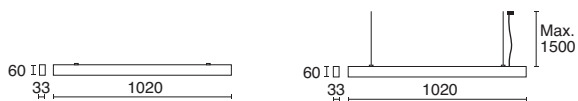

LED SMD 36W 3392lm 4000K

■ 1046A-L3336B-02



■ 1046B-L3336B-02

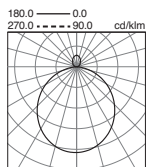

Acabado negro / Black finish







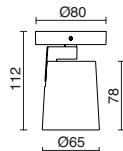

GU10 7.5W max. LED Retrofit

- 1021A-G21X1A-01
- 1021A-G21X1A-02



- Carril no incluido.
- Track not included.

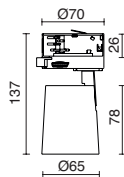

GU10 7.5W max. LED Retrofit

- 1021B-G21X1A-01
- 1021B-G21X1A-02



Carril / Track p.254-257

ALU



Acabado blanco o negro / White or black finish

Lamps p.790





• Carril no incluido.  
• Track not included.

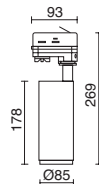

### 2700K

LED 25W 2729lm

- 997A-L3825B20-01
- 997A-L3825B20-02

- 997A-L3825B30-01
- 997A-L3825B30-02

- 997A-L3825B60-01
- 997A-L3825B60-02

### 3000K

LED 25W 2817lm

- 997A-L3925B20-01
- 997A-L3925B20-02

- 997A-L3925B30-01
- 997A-L3925B30-02

- 997A-L3925B60-01
- 997A-L3925B60-02

### 4000K

LED 25W 2874lm

- 997A-L4025B20-01
- 997A-L4025B20-02

- 997A-L4025B30-01
- 997A-L4025B30-02

- 997A-L4025B60-01
- 997A-L4025B60-02



Carril / Track p.254-257



Adaptador para techo / Adapter for ceiling

- B25-X33X2B-01
- B25-X33X2B-02

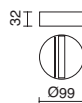

Acabado blanco o negro / White or black finish



G53 LED AR111 12V (DIM.C)

- 772B-G18RCB-01
- 772B-G18RCB-02
- 772B-G18RCB-03



G53 QR-LP 111 12V 75W max. (DIM.LC)

- 772B-H18RCB-01
- 772B-H18RCB-02
- 772B-H18RCB-03

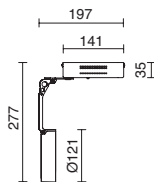

G53 LED AR111 12V (DIM.C)

- 772A-G18RCB-01
- 772A-G18RCB-02
- 772A-G18RCB-03

• Carril no incluido.  
• Track not included.

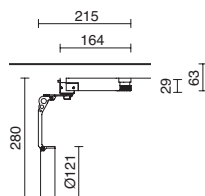

Filtros de conversión para pescado, marisco, verdura, carne o pan  
Conversion for fish, seafood, vegetables, meat or bread

	SEAFOOD	A14A-738-00	for 3000K
	VEG+FRUIT	A14A-738-00	
	FISH	A14A-738-00	for 4000K
	MEAT	A14B-738-00	
	BREAD	A14C-738-00	

Porta filtros / Support for filters

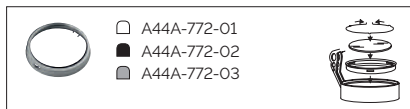

Aro customizable  
Customizable ring

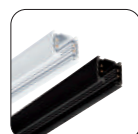

Carril / Track p.254-257



Acabado blanco, negro o gris / White, black or grey finish

Lamps p.790

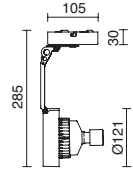

GU10 LED AR111 230V

- 772B-G21X1B-01
- 772B-G21X1B-02
- 772B-G21X1B-03



• Carril no incluido.  
• Track not included.

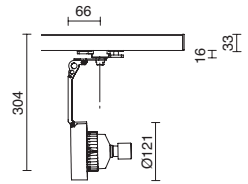

GU10 LED AR111 230V

- 772A-G21X1B-01
- 772A-G21X1B-02
- 772A-G21X1B-03



Filtros de conversión para pescado, marisco, verdura, carne o pan  
Conversion for fish, seafood, vegetables, meat or bread

	SEAFOOD	A14A-738-00	for 3000K
	VEG+FRUIT	A14A-738-00	
for 4000K			
	FISH	A14A-738-00	
	MEAT	A14B-738-00	
	BREAD	A14C-738-00	

Porta filtros / Support for filters

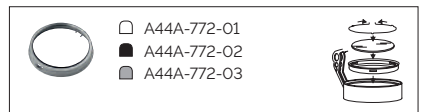

Aro customizable  
Customizable ring



Carril / Track p.254-257



Acabado blanco, negro o gris / White, black or grey finish

Lamps p.790

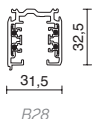
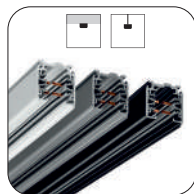

B28

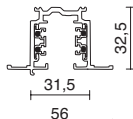
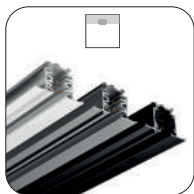

B30

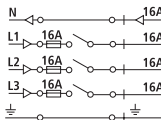

1m

- B28A-X33X2B-01
- B28A-X33X2B-02
- B28A-X33X2B-39

2m

- B28B-X33X2B-01
- B28B-X33X2B-02
- B28B-X33X2B-39

3m

- B28C-X33X2B-01
- B28C-X33X2B-02
- B28C-X33X2B-39



1m

- B30A-X33X2B-01
- B30A-X33X2B-02
- B30A-X33X2B-39

2m

- B30B-X33X2B-01
- B30B-X33X2B-02
- B30B-X33X2B-39

3m

- B30C-X33X2B-01
- B30C-X33X2B-02
- B30C-X33X2B-39



ALU



Acabado blanco, negro o aluminio anodizado / White, black or anodised aluminium finish

**Alimentación derecha**  
Live end right

- B28D-X33X2B-01
- B28D-X33X2B-02
- B28D-X33X2B-03

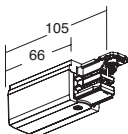

**Alimentación izquierda**  
Live end left

- B28E-X33X2B-01
- B28E-X33X2B-02
- B28E-X33X2B-03

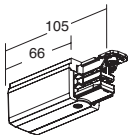

**Alimentación central**  
Supply straight coupling

- B28H-X33X2B-01
- B28H-X33X2B-02
- B28H-X33X2B-03

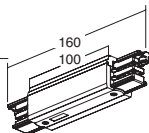

**Unión flexible**  
Flexible junction coupling

- B28K-X33X2B-01
- B28K-X33X2B-02
- B28K-X33X2B-03

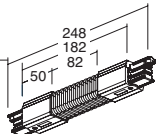

**Unión en cruz**  
"X" junction coupling

- B28J-X33X2B-01
- B28J-X33X2B-02
- B28J-X33X2B-03

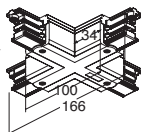

**Codo 90° interior**  
90° in junction coupling

- B28G-X33X2B-01
- B28G-X33X2B-02
- B28G-X33X2B-03

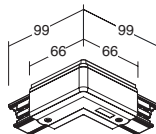

**Codo 90° exterior**  
90° out junction coupling

- B28M-X33X2B-01
- B28M-X33X2B-02
- B28M-X33X2B-03

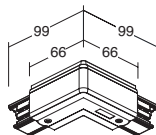

**T derecha / T live right**

- B28I-X33X2B-01
- B28I-X33X2B-02
- B28I-X33X2B-03

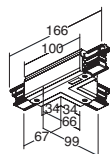

**T izquierda / T live left**

- B28N-X33X2B-01
- B28N-X33X2B-02
- B28N-X33X2B-03

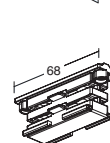

**Unión con contacto**  
Straight coupling with supply

- B28L-X33X2B-01
- B28L-X33X2B-02
- B28L-X33X2B-03

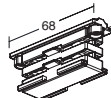

**Tapa final**  
Dead end

- A61G-786-01
- A61G-786-02
- A61G-786-03

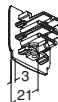

Acabado blanco, negro o gris / White, black or grey finish

## Tapa lineal (carril empotrado) Linear cap (recessed track)

- A61H-786-01
- A61H-786-02
- A61H-786-03

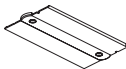

Para /For:  
B28E- B28D- B28H-

## Tapa cruz (carril empotrado) Cross cover (recessed track)

- A61J-786-01
- A61J-786-02
- A61J-786-03



Para /For:  
B28G- B28M- B28I- B28N- B28J-

## Base SCHUKO carril SCHUKO base track

- B17O-X33X2B-01
- B17O-X33X2B-02



## Adaptador universal Universal adaptor

- B17F-X33X2B-01
- B17F-X33X2B-02
- B17F-X33X2B-03

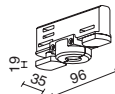

## Leva para carril empotrado Recessed for track cam

- A61M-786-03



## Leva para techo o tija Clip for ceiling and rod

- A61E-786-01
- A61E-786-02
- A61E-786-03



## Cable de acero Steel cable

- A61A-786-01 (1500mm)
- A61A-786-02 (1500mm)
- A61A-786-03 (1500mm)



- A61B-786-01 (3000mm)
- A61B-786-02 (3000mm)
- A61B-786-03 (3000mm)

## Tija Pendant

- A61C-786-01 (1000mm)
- A61C-786-02 (1000mm)
- A61D-786-01 (1000mm)
- A61D-786-02 (1000mm)
- A61H-786-39

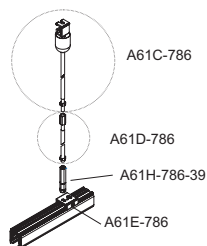

## EJEMPLOS DE INSTALACIÓN / INSTALLATION EXAMPLES

Vista cenital / Top view

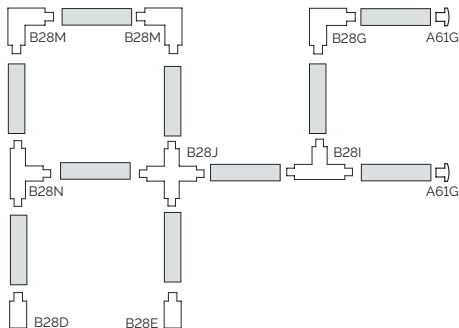

## Herramienta para doblar conductores carril Track conductor bending tool

A61N-786-00

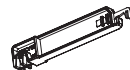

Corte carril a medida  
uso herramienta especial  
A61N-786-00

Video



Three-phase rail  
cut to length use of  
special tool A61N-786-00

Video



Acabado blanco, negro o aluminio anodizado / White, black or anodised aluminium finish

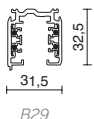
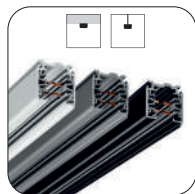

B29

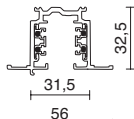
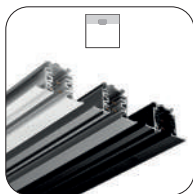

B31

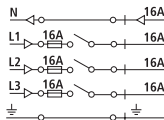

### 1m

- B29A-X33X2U-01
- B29A-X33X2U-02
- B29A-X33X2U-39

### 2m

- B29B-X33X2U-01
- B29B-X33X2U-02
- B29B-X33X2U-39

### 3m

- B29C-X33X2U-01
- B29C-X33X2U-02
- B29C-X33X2U-39



### 1m

- B31A-X33X2U-01
- B31A-X33X2U-02
- B31A-X33X2U-39

### 2m

- B31B-X33X2U-01
- B31B-X33X2U-02
- B31B-X33X2U-39

### 3m

- B31C-X33X2U-01
- B31C-X33X2U-02
- B31C-X33X2U-39



ALU



Acabado blanco, negro o aluminio anodizado / White, black or anodised aluminium finish

#### Alimentación derecha Live end right

- B29D-X33X2U-01
- B29D-X33X2U-02
- B29D-X33X2U-03

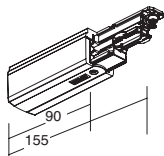

#### Codo 90° interior 90° in junction coupling

- B29F-X33X2U-01
- B29F-X33X2U-02
- B29F-X33X2U-03

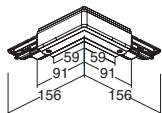

#### Alimentación izquierda Live end left

- B29E-X33X2U-01
- B29E-X33X2U-02
- B29E-X33X2U-03

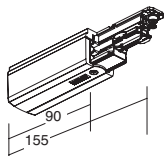

#### Codo 90° exterior 90° out junction coupling

- B29L-X33X2U-01
- B29L-X33X2U-02
- B29L-X33X2U-03

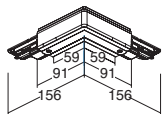

#### Tapa final Dead end

- A61G-786-01
- A61G-786-02
- A61G-786-03

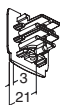

#### T derecha / T live right

- B29H-X33X2U-01
- B29H-X33X2U-02
- B29H-X33X2U-03

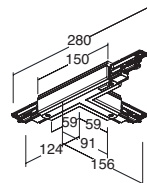

#### Unión flexible Flexible junction coupling

- B29J-X33X2U-01
- B29J-X33X2U-02
- B29J-X33X2U-03

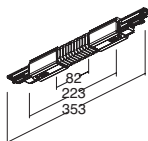

#### T izquierda / T live left

- B29M-X33X2U-01
- B29M-X33X2U-02
- B29M-X33X2U-03

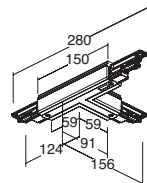

Acabado blanco, negro o gris / White, black or grey finish



## Unión en cruz "X" junction coupling

- B29I-X33X2U-01
- B29I-X33X2U-02
- B29I-X33X2U-03

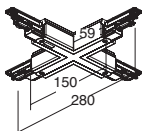

## Unión con contacto Straight coupling with supply possibility

- B29K-X33X2U-01
- B29K-X33X2U-02
- B29K-X33X2U-03

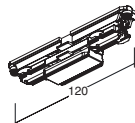

## Tapa lineal (carril empotrado) Linear cap (recessed track)

- A61K-786-01
- A61K-786-02
- A61K-786-03

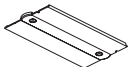

Para /For B29E- B29D-

## Tapa cruz (carril empotrado) Cross cover (recessed track)

- A61L-786-01
- A61L-786-02
- A61L-786-03



Para /For B29F- B29L- B28H- B29M- B29I-

## Leva para carril empotrado Recessed for track cam

- A61M-786-03



## Leva para techo o tija Clip for ceiling and rod

- A61E-786-01
- A61E-786-02
- A61E-786-03



## Cable de acero Steel cable

- A61A-786-01 (1500mm)
- A61A-786-02 (1500mm)
- A61A-786-03 (1500mm)
- A61B-786-01 (3000mm)
- A61B-786-02 (3000mm)
- A61B-786-03 (3000mm)



## Tija Pendant

- A61C-786-01 (1000mm)
- A61C-786-02 (1000mm)
- A61D-786-01 (1000mm)
- A61D-786-02 (1000mm)
- A61H-786-39

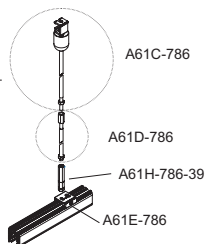

## EJEMPLOS DE INSTALACIÓN / INSTALLATION EXAMPLES

Vista cenital / Top view

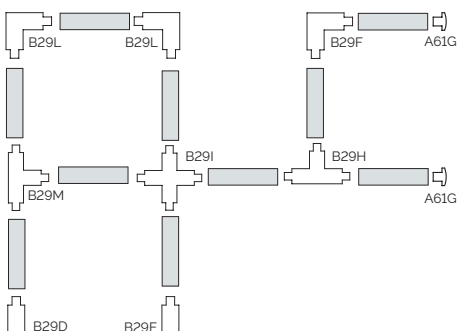

## Herramienta para doblar conductores carril Track conductor bending tool

A61N-786-00

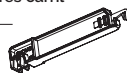

Corte carril a medida  
uso herramienta especial  
A61N-786-00

Video



Three-phase rail  
cut to length use of  
special tool A61N-786-00

Video



Acabado blanco, negro o aluminio anodizado / White, black or anodised aluminium finish

DECORAT  
INDOOR

TIVE

exo  
lighting

Madera — Wood



Metales — Metals

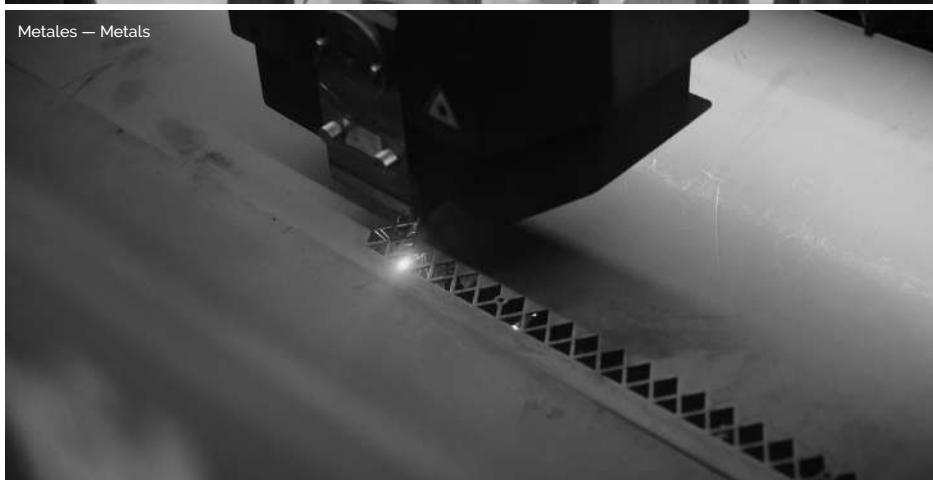

Fibras naturales — Natural fibers



# Ilumina tu imaginación

En Novolux Lighting, contamos con talleres propios de fabricación y montaje, lo que nos permite crear luminarias decorativas a medida para proyectos. Nos adaptamos a cualquier necesidad, trabajando con aluminio, madera, cristal, metacrilato, entre otros materiales. En el proceso de fabricación de lámparas de aluminio, realizamos corte láser, torneado, soldadura y baño de pintura. Para lámparas de madera, llevamos a cabo el corte, pintura con pistola, montaje, entre otros procesos. También fabricamos lámparas con diversos materiales y fibras naturales, así como lámparas con cristales y metacrilatos. Además, tenemos capacidad, conocimiento y experiencia en la fabricación de lámparas big format. Somos también especialistas en la fabricación de pantallas a medida, con una amplia variedad de acabados y materiales, adaptándonos a cualquier tamaño o medida especial.

## Light up your imagination

At Novolux Lighting, we have our own manufacturing and assembly workshops, allowing us to create custom decorative lighting for projects. We adapt to any requirement, working with materials such as aluminum, wood, glass, acrylic, among others. In the aluminum lamp manufacturing process, we employ laser cutting, turning, welding, and painting. For wooden lamps, we carry out cutting, spray painting, assembly, among other processes. We also manufacture lamps using various materials and natural fibers, as well as lamps with crystals and acrylics. Additionally, we have the capability, knowledge, and experience in manufacturing large-format lamps. We are also specialists in the production of custom lampshades, offering a wide variety of finishes and materials, accommodating any size or special measurement.





Wall lights





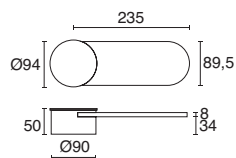
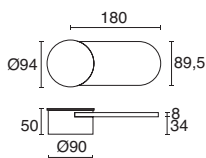

**L180**  
LED SMD 4,5W 3000K

**L235**  
LED SMD 4,5W 3000K

- 1076A-L3105B-01
- 1076A-L3105B-02
- 1076A-L3105B-46

- 1076B-L3105B-01
- 1076B-L3105B-02
- 1076B-L3105B-46



Acabado blanco, negro u oro mate / White, black or matt gold finish

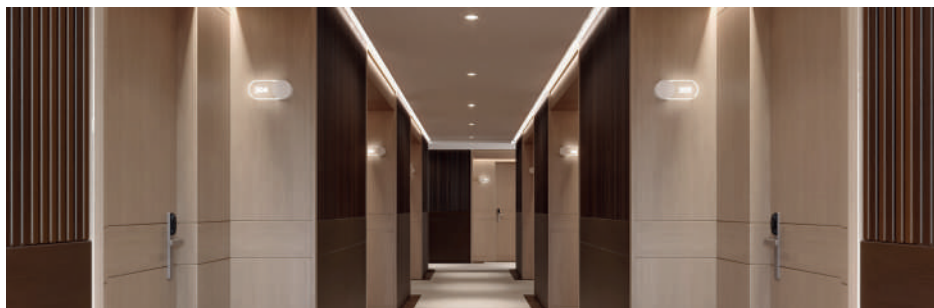

Diseño personalizable / Customisable design

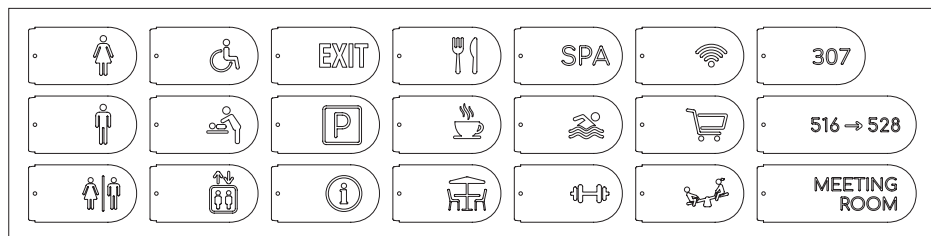



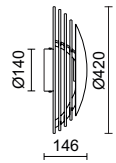

GX53 LED T2 10W 1200lm 3000K

1073B-L3110A-50

WOOD



Acabado madera haya / Beech wood finish

p.377



p.315







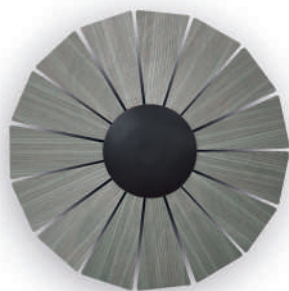

962A-



962C-

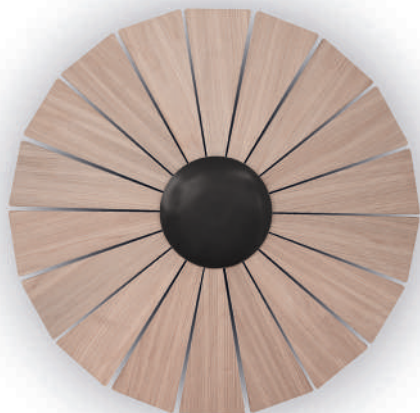

962B-

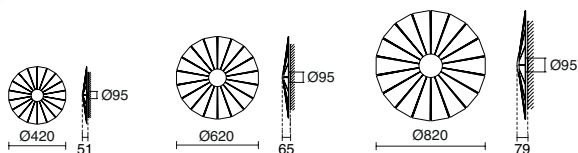

### Ø420

LED SMD 14W 1863lm 3000K

- 962A-L3114B-02-W1
- N 962A-L3114B-02-W2
- N 962A-L3114B-02-W3

### Ø620

LED SMD 21W 2794lm 3000K

- N ■ 962B-L3114B-02-W1
- 962B-L3114B-02-W2
- N ■ 962B-L3114B-02-W3

### Ø820

LED SMD 28W 3479lm 3000K

- N ■ 962C-L3114B-02-W1
- N ■ 962C-L3114B-02-W2
- 962C-L3114B-02-W3



Acabado negro con aspas madera oscura, natural o clara  
Black finish with dark wood, natural or light wood blades



Posibilidad de imprimir diseño personalizado  
Possibility to print customised design





# KRISTA

BY NACHO TIMÓN

WALL LIGHTS



-FG



-05



-06

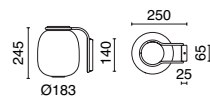

LED SMD AC 10W 830lm 2700K

- 1028G-L38RCB-02-FG
- 1028G-L38RCB-02-05
- 1028G-L38RCB-02-06



Acabado negro con cristal fougé, verde o azul / Black finish with fougé, green or blue glass







# TOSCA

BY NACHO TIMÓN

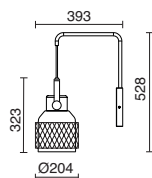

E27 Led/Fluo/Hal. max. 60W

- 956C-G05X1A-01
- 956C-G05X1A-02
- 956C-G05X1A-06

ACER + ALU



Acabado blanco, negro o azul / White, black or blue finish

Lamps p.791



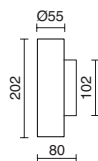

2x GU10 Led/Hal max. 50W

- 906A-G21X1A-01
- 906A-G21X1A-02
- 906A-G21X1A-37
- 906A-G21X1A-47



Acabado blanco, negro, cobre o oro / Finished in white, black, copper or gold

Lamps p.792

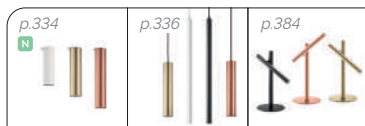



2x LED SMD AC 4W 400lm 3000K

- 906D-L31H1B-01
- 906D-L31H1B-02
- 906D-L31H1B-37
- 906D-L31H1B-47



Acabado blanco, negro, cobre o oro / Finished in white, black, copper or gold

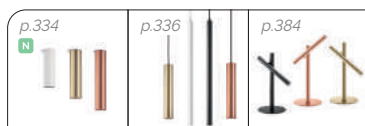



E27 Led / Fluo / Hal max. 40W

- 984F-G05X1A-02
- 984F-G05X1A-32
- 984F-G05X1A-47



- 984F-G05X1A-02-27
- 984F-G05X1A-32-27
- 984F-G05X1A-47-27



Acabado negro, cromado o dorado / Black, chrome or gold finish

Lamps p.791



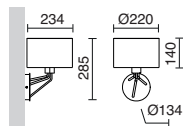

E27 Led max. 13W (Ø45)

- ○ 855E-G05X1A-01-SA
- ● 855E-G05X1A-02-SB
- ● 855E-G05X1A-37-SM



Acabado blanco, negro o cobre / White, black or copper finish

Lamps p.791



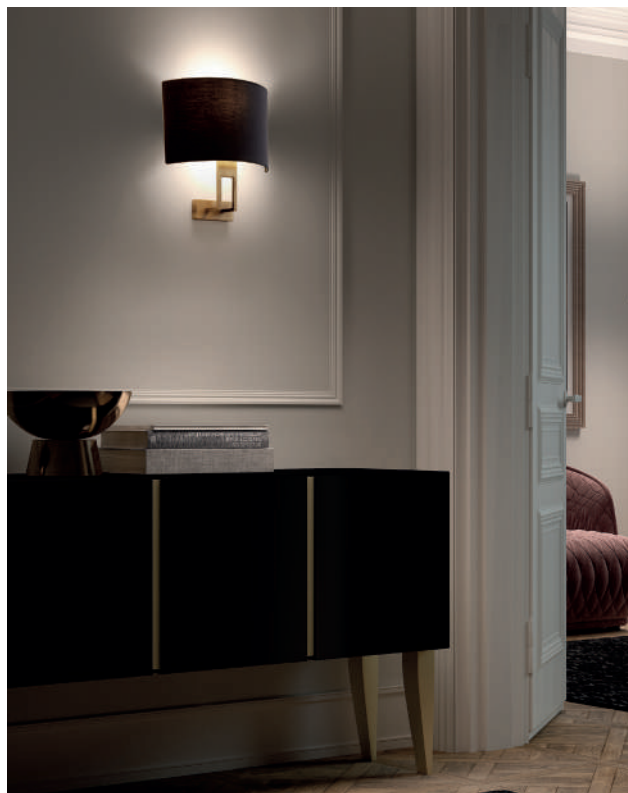

Nuevo acabado de pintura  
New colour finish

E27 Led/Fluo/Hal max. 40W (Ø45)

● ○ 986A-G05X1A-35-CA

● ● 986A-G05X1A-47-CB

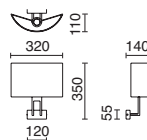

Nuevo acabado de pintura  
New colour finish



Acabado níquel satinado o dorado con pantalla ribbon wrapped blanca o ribbon wrapped negra  
Satin nickel or gold finish with white ribbon wrapped or black ribbon wrapped shade

Lamps p.791



# AMSTERDAM

WALL LIGHTS

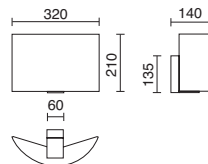

E27 (Ø45) Led / Fluo / Hal max. 40W

- 909C-G05X1A-35-CA
- 909C-G05X1A-35-CB
- 909C-G05X1A-35-CG



- 908G-G05X1A-35-RA
- 908G-G05X1A-35-RB
- 908G-G05X1A-35-RC



ACER



Acabado níquel satinado con pantalla blanca, negra, marrón o beige  
Satin nickel finish with white, black, brown or beige shade

Lamps p.791





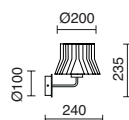

E27 Led/Fluo/Hal. max. 40W (Ø45)

□ ○ 859D-G05X1A-01-RA

■ ● 859D-G05X1A-02-RB



Acabado blanco o negro / White or black finish

Lamps p.791





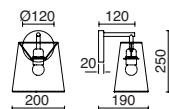

E27 Led / Fluo / Hal max. 40W

- 1017A-G05X1A-01-D1
- 1017A-G05X1A-01-D2
- 1017A-G05X1A-01-D3
- 1017A-G05X1A-02-D4



Acabado cuerpo blanco o negro y pantalla sintética blanca, beige, marrón o negro fabric  
White or black body finish and synthetic white, beige, brown, beige or black fabric shade finish

Lamps p.791



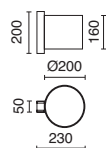

E27 Led / Fluo / Hal max. 40W (Ø45)

- 621C-G05X1A-50-CA
- 621C-G05X1A-50-DC
- 621C-G05X1A-50-CG



Acabado madera de haya con pantalla cotton white, eco beige o cotton earth  
Beech wood finish with cotton white, eco beige or cotton earth shades

Lamps p.791



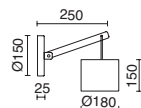

E27 Led / Fluo / Hal max. 60W

■ 681A-G05X1A-02

ACER + WOOD

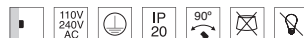

Acabado negro con pantalla cotton white / Black finish with cotton white shade

Lamps p.791

Accesorio necesario / Necessary accessory

	<b>PANTALLA / SHADE</b> ○ A35C-004-CA		
---	--	---	---





# FIRENZE

WALL LIGHTS

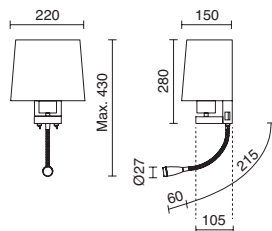

E27 Led / Fluo / Hal max. 60W + LED SMD 3W 240lm 3000K

507E-Y05X1B-35



E27 Led / Fluo / Hal max. 60W + LED SMD 3W 240lm 3000K

507A-Y05X1B-35

507A-Y05X1B-46



507F-Y05X1B-35

507F-Y05X1B-46



ACER



Acabado níquel satinado o oro mate con pantalla blanca, negra o beige  
Satin nickel finish or matt gold with white, black or beige shade

Lamps p.791

Accesorio necesario / Necessary accessory



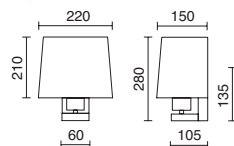

E27 Led / Fluo / Hal max. 60W

● 507B-G05X1A-35

ACER



Acabado níquel satinado con pantalla blanca, negra o beige  
Satin nickel finish with white, black or beige shade

Lamps p.791

Accesorio necesario / Necessary accessory

## PANTALLAS / SHADES

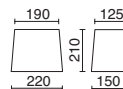

- A26A-004-CA
- A26A-004-CB
- A26A-004-CC

- A27A-004-CA
- A27A-004-CB
- A27A-004-CC

(COTTON)

p.285



p.353



p.398



p.399





# A TU ESTILO

WALL LIGHTS

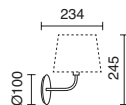

E27 Led / Fluo / Hal max. 60W

- 717C-G05X1A-02
- 717C-G05X1A-32

ACER



Acabado negro o cromo con pantalla de algodón blanco, beige, gris, rojo, cappuccino o yute beige  
Black or chrome finish with white, beige, grey, red, cappuccino or beige jute cotton shade

Lamps p.791

Accesorio necesario / Necessary accessory

## PANTALLAS / SHADES



- A26E-004-CA
- A26E-004-CC
- A26E-004-CK
- A26E-004-CJ
- A26E-004-CE
- A26E-004-HC



# VALAN

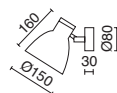

E27 Led / Fluo / Hal max. 60W (Ø45)

- 846B-G05X1A-01
- 846B-G05X1A-MK
- 846B-G05X1A-BL

ACER + WOOD

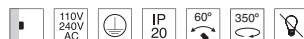

Acabado blanco, moka o azul claro / White, mocha or light blue finish

Lamps p.791



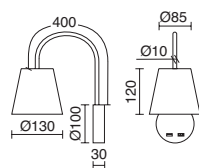

E27 Led / Fluo / Hal max. 60W (Ø45)

●● 907B-G05X1A-02-CB



Acabado negro / Black finish

Lamps p.791





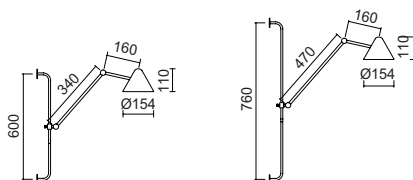
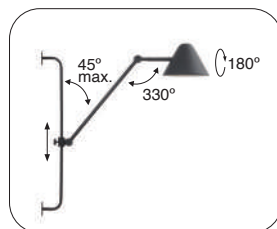

LED COB 5W 3000K 728lm

■ 935A-L3105B-02

■ 935B-L3105B-02

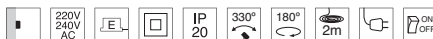

Acabado negro / Black finish

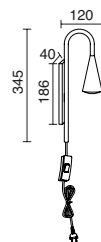

GU10 (Led / Hal) max. 20W

□ 991A-G21X1A-01

■ 991A-G21X1A-02



Acabado blanco o negro / White or black finish

Lamps p.792

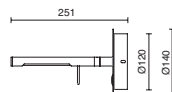

LED SMD 4W 3000K 280lm

■ 588A-L0104A-02



Acabado negro / Black finish

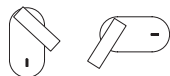

Doble posición  
Double position

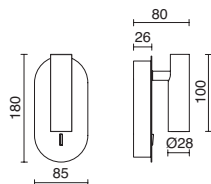

LED SMD 3W 200lm 3000K

- 704A-L0103B-01
- 704A-L0103B-02
- 704A-L0103B-02-47

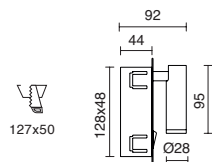

LED SMD 3W 200lm 3000K

- 704B-L0103B-01
- 704B-L0103B-02
- 704B-L0103B-02-47

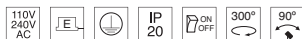

Acabado blanco, negro o dorado / White, black or gold finish

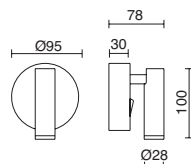

LED SMD 3W 200lm 3000K

- 977A-L0103A-01
- 977A-L0103A-02
- 977A-L0103A-02-47



Acabado blanco, negro o oro / White, black or gold finish





# SKIN

BY NOVOLUX Technical Studio

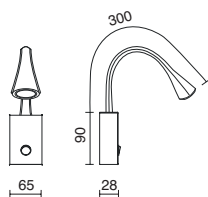

LED SMD 2W 160lm 3000K

- 955A-L0102A-01
- 955A-L0102A-02
- 955A-L0102A-07
- 955A-L0102A-14



Acabado blanco, negro, rojo o marrón / White, black, red or brown finish

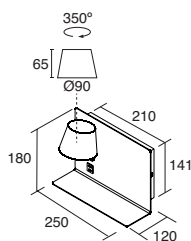
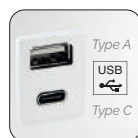

LED SMD 6W 732lm 3000K

- 1031A-L3106B-01
- 1031A-L3106B-02

Izquierda  Left

- 1031B-L3106B-01
- 1031B-L3106B-02

Derecha  Right



Acabado blanco o negro / White or black finish





Doble posición  
Double position

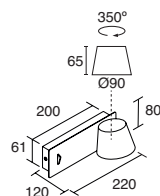
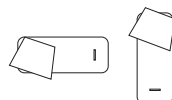

LED SMD 6W 732lm 3000K

□ 1031C-L3106B-01

■ 1031C-L3106B-02



Acabado blanco o negro / White or black finish

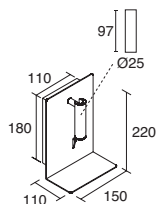
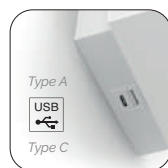

LED SMD 3W 251lm 3000K

□ 727G-L0103B-01

■ 727G-L0103B-02



Acabado blanco o negro / White or black finish

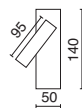

LED SMD 3W 200lm 3000K

- 842A-L0103B-01
- 842A-L0103B-02
- 842A-L0103B-35



Acabado blanco, negro o níquel satinado / White, black or satin nickel finish

# ELFI

WALL LIGHTS

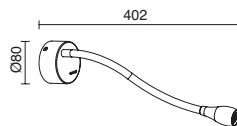

LED SMD 2W 160lm 3000K

■ 710A-LO103A-02

■ 710A-LO103A-07

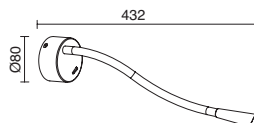

LED SMD 2W 160lm 3000K

■ 710B-LO103A-02

■ 710B-LO103A-07



Acabado negro o rojo / Black or red finish

# OLVAS

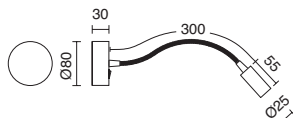
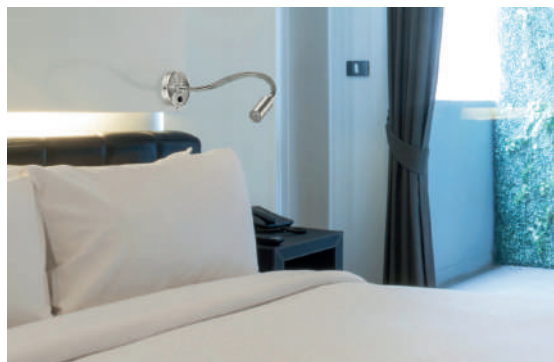

LED COB 5W 240lm 3000K

■ 518B-LO103A-35



Acabado niquel satinado / Satin nickel finish



Hotel Soho Boutique (Sevilla)

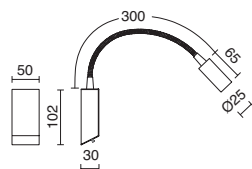

LED SMD 3W 240lm 3000K

- 517B-L0103B-35
- 517B-L0103B-46

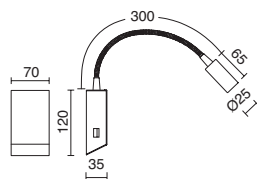

LED SMD 3W 240lm 3000K

- 517E-L0103B-35
- 517E-L0103B-46



Acabado níquel satinado u oro mate / Satin nickel or matt gold finish





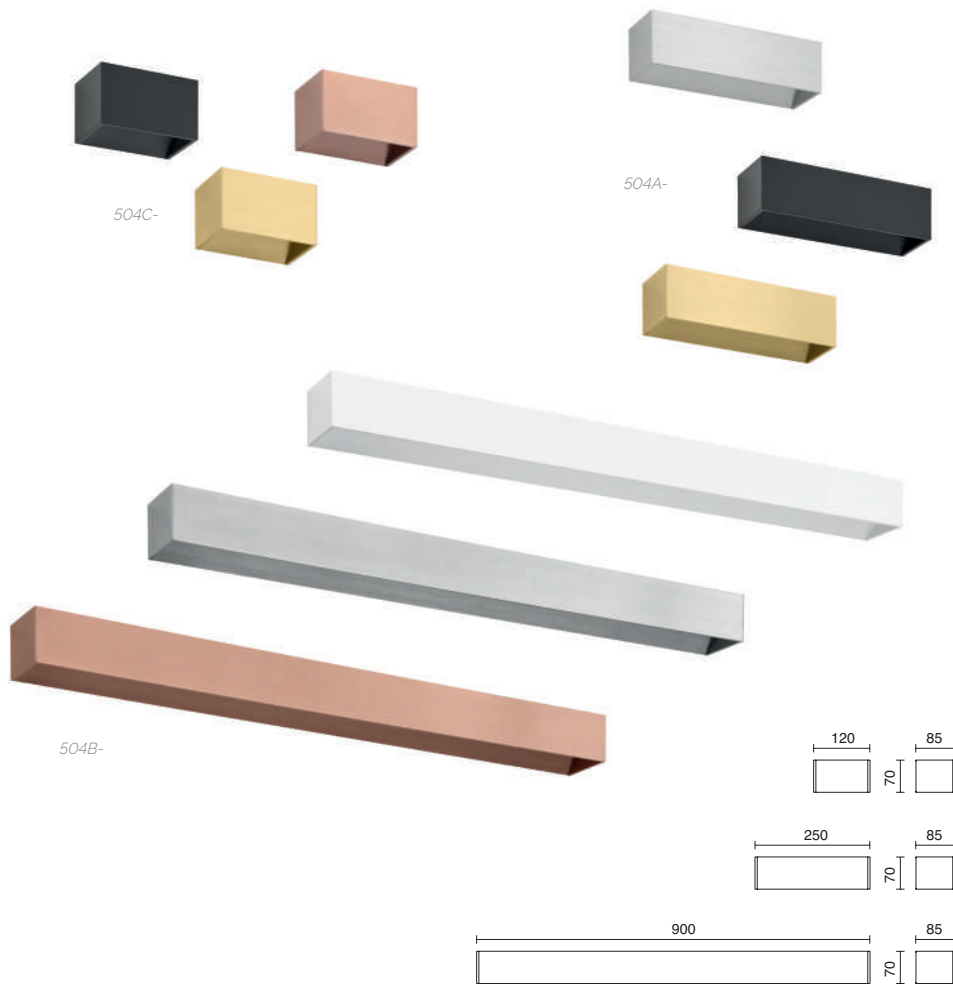

### L120

LED SMD 5W 450lm 3000K

- 504C-L0105B-01
- 504C-L0105B-02
- N ■ 504C-L0105B-BR
- 504C-L0105B-40
- N ■ 504C-L0105B-46

### L250

LED SMD 8W 790lm 3000K

- 504A-L0108B-01
- 504A-L0108B-02
- N ■ 504A-L0108B-BR
- 504A-L0108B-40
- N ■ 504A-L0108B-46

### L900

LED SMD 24W 2270lm 3000K

- 504B-L0124B-01
- 504B-L0124B-02
- N ■ 504B-L0124B-BR
- 504B-L0124B-40
- N ■ 504B-L0124B-46



Acabado blanco, negro, bronce, aluminio cepillado u oro mate / White, black, bronze, brushed aluminium or matt gold finish

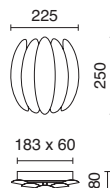

LED SMD 20W 2059lm 3000K

□ 1039A-L3120B-01

■ 1039A-L3120B-02

■ 1039A-L3120B-46



Acabado blanco, negro u oro mate / White, black or matt gold finish





**Ø200**  
LED SMD 9W 890lm 3000K

- 988A-LO109B-01
- 988A-LO109B-02

**Ø250**  
LED SMD 13W 1155lm 3000K

- 988B-LO113B-01
- 988B-LO113B-02

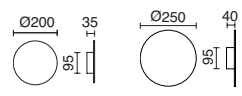

**Ø400**  
LED SMD 28W 3020lm 3000K

- N** □ 988C-LO128B-01
- N** ■ 988C-LO128B-02

**Ø500**  
LED SMD 40W 4040lm 3000K

- N** □ 988D-LO140B-01
- N** ■ 988D-LO140B-02

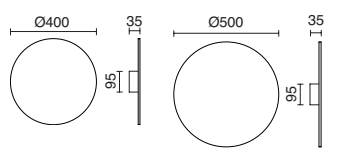

Acabado blanco o negro / White or black finish



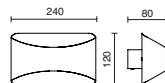

LED SMD 9W 850lm 3000K

- 987A-L0109B-01
- 987A-L0109B-02
- 987A-L0109B-BR
- 987A-L0109B-46



Acabado blanco , negro, bronce u oro mate / White, black, bronze or matt gold finish

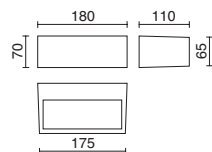

LED SMD 13W 1200lm 3000K

- 634A-L0113B-01
- 634A-L0113B-02
- 634A-L0113B-03



- 634B-L0113B-01
- 634B-L0113B-02
- 634B-L0113B-03



E27 (Ø45) Led / Fluo / Hal max. 40W

R7s (74,9mm) QT-DE 60W max.

- 634C-G05X1A-01
- 634C-G05X1A-02
- 634C-G05X1A-03

- 634A-H35X1A-01
- 634A-H35X1A-02
- 634A-H35X1A-03



Acabado blanco, negro o gris / White, black or grey finish

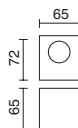

LED SMD 3W 165lm 3000K

- 412A -L0103B-01
- 412A -L0103B-02
- 412A -L0103B-40



2x LED SMD 3W 165lm 3000K

- 412B -L01E2B-01
- 412B -L01E2B-02
- 412B -L01E2B-40

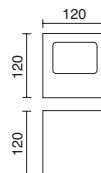

LED SMD 2x 5W 2x 325lm 3000K

- 412B -L01F1B-01
- 412B -L01F1B-02
- 412B -L01F1B-40



ALU



Acabado blanco, negro o aluminio cepillado / White, black or brushed aluminum finish

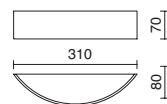

LED SMD 12W 1200lm 3000K

□ 695A-L0112B-01

■ 695A-L0112B-32



Acabado blanco o cromo / White or chrome finish

# MENKAR

WALL LIGHTS

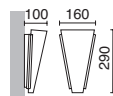

LED SMD 12W 1200lm 3000K

694B-LO112A-35



Acabado níquel satinado / Satin nickel finish

# ESPIGA

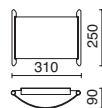

LED SMD 12W 1200lm 3000K

693A-LO112A-35



Acabado níquel satinado / Satin nickel finish

# PYRAMID



2x E27 (Led / Fluo / Hal) max. 60W

612A-GO5X1A-32



Acabado cromo / Chrome finish

Lamps p.791

# CIRCUS

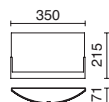
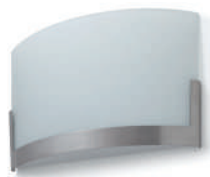

2x E27 Led / Fluo / Hal max. 60W

589A-GO5X1A-35



Acabado níquel satinado / Satin nickel finish

Lamps p.791





# Pendant & ceiling lamps



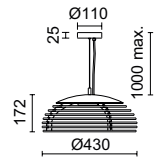

GX53 LED T2 10W 1200lm 3000K

1073C-L3110A-50

WOOD



Acabado madera haya / Beech wood finish

p.267



p.377





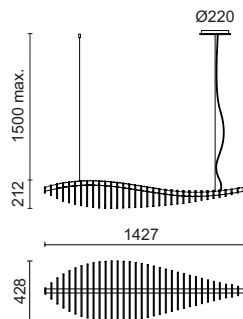

**2700K**  
LED SMD 26W 2870lm

- 1013B-L3826A-01
- 1013B-L3826A-02
- 1013B-L3826A-50

**4000K**  
LED SMD 26W 3170lm

- 1013B-L4026A-01
- 1013B-L4026A-02
- 1013B-L4026A-50



wood + ALU



Acabado blanco, negro o madera haya / White, black or beech wood finish

Posibilidad de regulación  
Possibility of regulation





# FISH

BY NACHO TIMÓN

PENDANT LAMPS

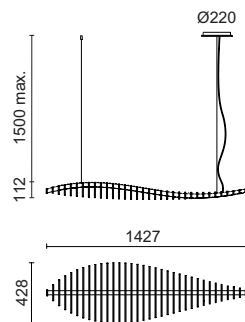

**2700K**  
LED SMD 26W 2870lm

- 1013A-L3826B-01
- 1013A-L3826B-02
- 1013A-L3826B-50

**4000K**  
LED SMD 26W 3170lm

- 1013A-L4026B-01
- 1013A-L4026B-02
- 1013A-L4026B-50



WOOD + ALU



Acabado blanco, negro o madera haya / White, black or beech wood finish

Posibilidad de regulación  
Possibility of regulation





# TWIST BY NACHO TIMÓN

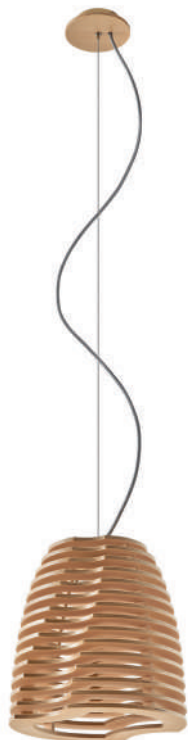

945C-



945D-

h. 1500 max.

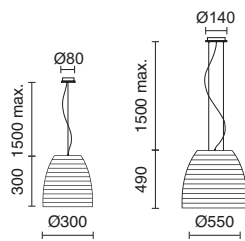

**Ø300**  
GX53 LED T2 6W 480lm 3000K

■ 945C-L3110A-50

**Ø550**  
GX53 LED T2 10W 1200lm 3000K

■ 945D-L3110A-50

WOOD



Acabado madera haya / Beech wood finish

p.379





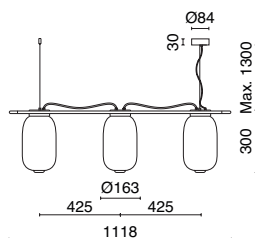
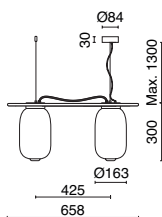
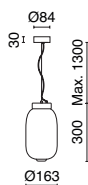
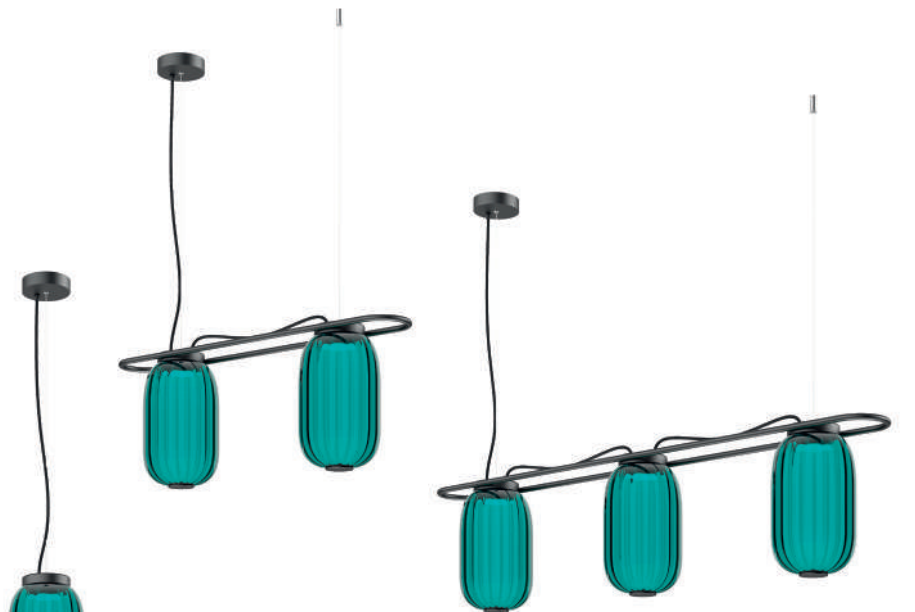

LED SMD AC 10W 830lm 2700K

■ 1028D-L38RCB-02-06



2x LED SMD AC 10W 1660lm 2700K

■ 1028E-L38RCB-02-06



3x LED SMD AC 10W 2490lm 2700K

■ 1028F-L38RCB-02-06



Acabado negro con cristal azul / Black finish with blue glass



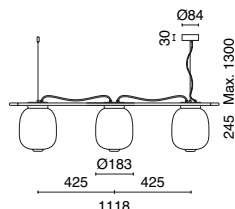
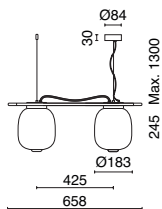
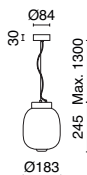
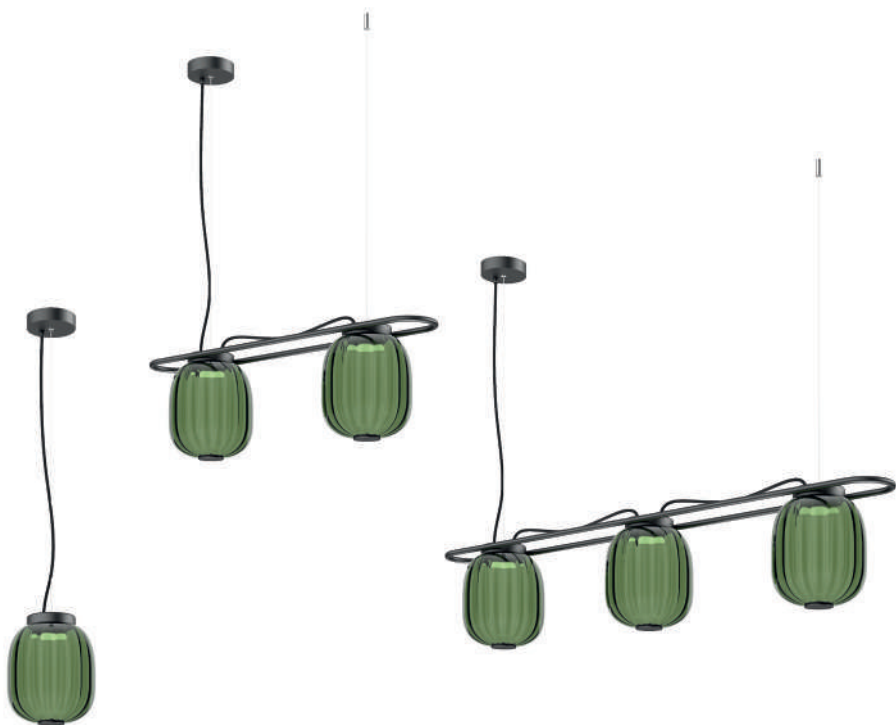



 LED SMD AC 10W 830lm 2700K

 2x LED SMD AC 10W 1660lm 2700K

 3x LED SMD AC 10W 2490lm 2700K

 1028A-L38RCB-02-05

 1028B-L38RCB-02-05

 1028C-L38RCB-02-05



Acabado negro con cristal verde / Black finish with green glass



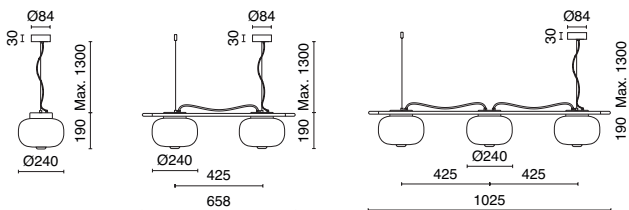

LED SMD AC 10W 830lm 2700K

■ ■ 1028H-L38RCB-02-FG



2x LED SMD AC 10W 1660lm 2700K

■ ■ 1028I-L38RCB-02-FG



3x LED SMD AC 10W 2490lm 2700K

■ ■ 1028J-L38RCB-02-FG



Acabado negro con cristal fougé / Black finish with fougé glass

p.271



p.381





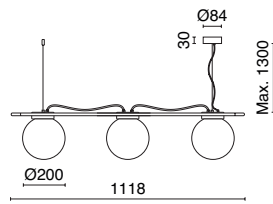
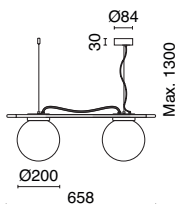
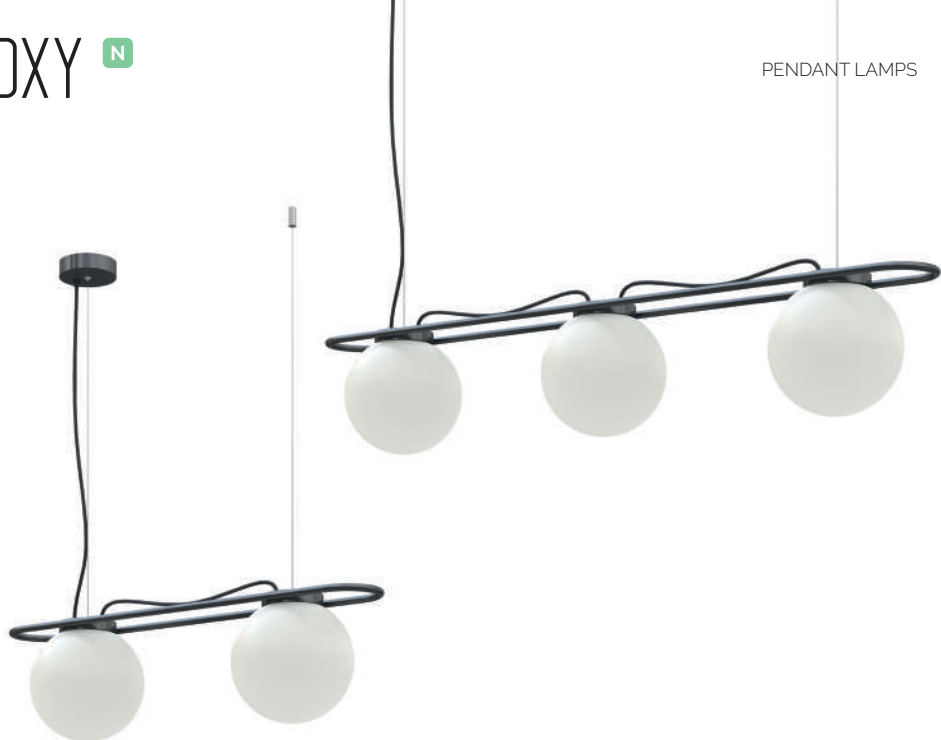

2x E27 Led / Fluo / Hal max. 40W

■ 984K-G05X1A-02-27



3x E27 Led / Fluo / Hal max. 40W

■ 984L-G05X1A-02-27



Acabado negro / Black finish



Lamps p.791











## Ø200

E27 Led / Fluo / Hal max. 40W

- 984A-G05X1A-02
- ▣ 984A-G05X1A-32
- 984A-G05X1A-47

## Ø250

E27 Led / Fluo / Hal max. 40W

- 984B-G05X1A-02
- ▣ 984B-G05X1A-32
- 984B-G05X1A-47



- 984A-G05X1A-02-27
- ▣ 984A-G05X1A-32-27
- 984A-G05X1A-47-27

- 984B-G05X1A-02-27
- ▣ 984B-G05X1A-32-27
- 984B-G05X1A-47-27



## Ø300

E27 Led / Fluo / Hal max. 60W

- 984C-G05X1A-02
- ▣ 984C-G05X1A-32
- 984C-G05X1A-47

## Ø350

E27 Led / Fluo / Hal max. 60W

- 984D-G05X1A-02
- ▣ 984D-G05X1A-32
- 984D-G05X1A-47

## Ø400

E27 Led / Fluo / Hal max. 60W

- 984E-G05X1A-02
- ▣ 984E-G05X1A-32
- 984E-G05X1A-47



- 984C-G05X1A-02-27
- ▣ 984C-G05X1A-32-27
- 984C-G05X1A-47-27

- 984D-G05X1A-02-27
- ▣ 984D-G05X1A-32-27
- 984D-G05X1A-47-27



Acabado negro, cromo u oro / Black, chrome or gold finish

Lamps p.791

### Adaptador carril / Rail adapter

- B17P-X33X2B-01
- B17P-X33X2B-02
- B17P-X33X2B-03

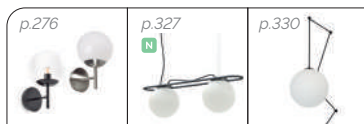



**Ø300**  
E27 Led / Fluo / Hal max. 40W

■ 984H-G05X1A-02-27

**Ø350**  
E27 Led / Fluo / Hal max. 40W

■ 984I-G05X1A-02-27

**Ø400**  
E27 Led / Fluo / Hal max. 40W

■ 984J-G05X1A-02-27



Acabado negro / Black finish

Lamps p.791



Numerosas opciones / Many options

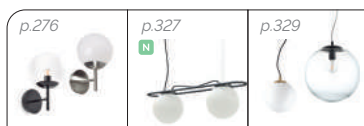
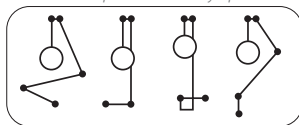

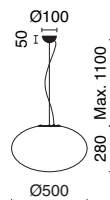
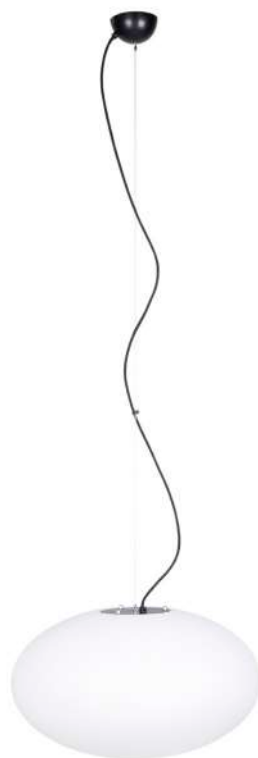

E27 Led / Fluo / Hal 15W

■ 1045A-G05X1A-02



Acabado negro / Black finish

Lamps p.791



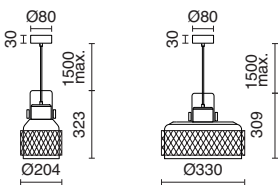

## Ø204

E27 Led/Fluo/Hal max. 60W

- 956A-G05X1A-01
- 956A-G05X1A-02
- 956A-G05X1A-06

## Ø330

E27 Led/Fluo/Hal max. 60W

- 956B-G05X1A-01
- 956B-G05X1A-02
- 956B-G05X1A-06

ACER + ALU



Acabado blanco, negro o azul / White, black or blue finish

Lamps p.791

### Adaptador carril / Rail adapter

- B17P-X33X2B-01
- B17P-X33X2B-02
- B17P-X33X2B-03



p.273







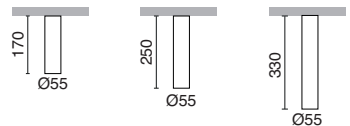

### h170

GU10 Led/Hal. max. 50W

- 906H-G21X1A-01
- 906H-G21X1A-02
- 906H-G21X1A-37
- 906H-G21X1A-47

### h250

GU10 Led/Hal. max. 50W

- 906J-G21X1A-01
- 906J-G21X1A-02
- 906J-G21X1A-37
- 906J-G21X1A-47

### h330

GU10 Led/Hal. max. 50W

- 906K-G21X1A-01
- 906K-G21X1A-02
- 906K-G21X1A-37
- 906K-G21X1A-47



Acabado blanco, negro, cobre u oro / White, black, cooper or gold finish

Lamps p.792

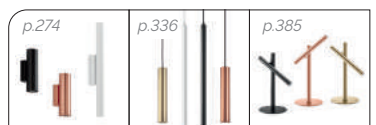





# TANIA

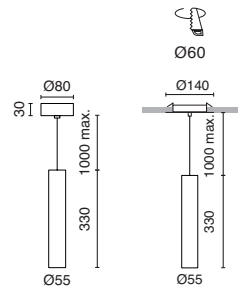

GU10 Led/Hal. max. 50W

- 906B-G21X1A-01
- 906B-G21X1A-02
- 906B-G21X1A-37
- 906B-G21X1A-47



- 906C-G21X1A-01
- 906C-G21X1A-02
- 906C-G21X1A-37
- 906C-G21X1A-47



Acabado blanco, negro, cobre u oro / White, black, cooper or gold finish

Lamps p.792

## Adaptador carril / Rail adapter

- B17P-X33X2B-01
- B17P-X33X2B-02
- B17P-X33X2B-03





# TANIA

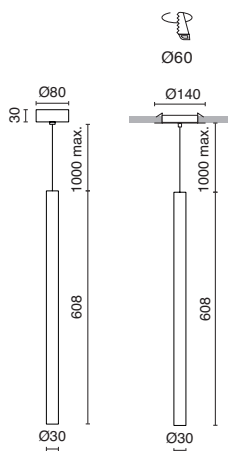
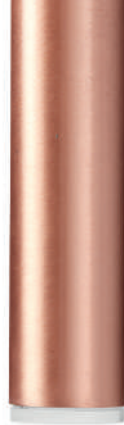

LED SMD AC 4W 400lm 3000K

- 906E-L3104B-01
- 906E-L3104B-02
- 906E-L3104B-37
- 906E-L3104B-47



- 906F-L3104B-01
- 906F-L3104B-02
- 906F-L3104B-37
- 906F-L3104B-47



Acabado blanco, negro, cobre u oro / White, black, cooper or gold finish

## Adaptador carril / Rail adapter

- B17P-X33X2B-01
- B17P-X33X2B-02
- B17P-X33X2B-03



# DIAGONAL

BY NACHO TIMÓN

PENDANT LAMPS

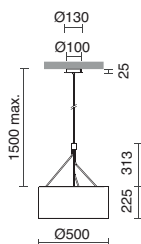

3x E27 Led max. 13W

□ ○ 855D-G05X1A-01-SA

■ ● 855D-G05X1A-02-SB

● ● 855D-G05X1A-37-SM



Acabado blanco, negro o cobre / White, black or copper finish

Lamps p.791



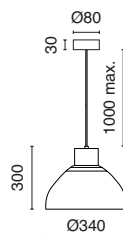

E27 Led / Fluor / Hal max. 60W

- 844A-G05X1A-01
- 844A-G05X1A-MK
- 844A-G05X1A-BL

ACER + WOOD



Acabado blanco, moka o azul claro / White, mocha or light blue finish

Lamps p.791

Adaptador carril / Rail adapter

- B17P-X33X2B-01
- B17P-X33X2B-02
- B17P-X33X2B-03



p.287



p.415







# AKIRO

BY NACHO TIMÓN



1014B-



1014A-

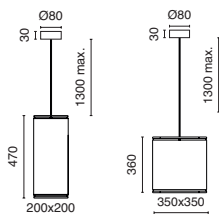

## h470

E27 Led max. 15W

- ○ 1014A-G05X1A-02
- ● 1014A-G05X1A-02-SC

## h360

E27 Led max. 15W

- ○ 1014B-G05X1A-02
- ● 1014B-G05X1A-02-SC



Acabado negro / Black finish

Lamps p.791



Pantalla de pergamino sintético  
Synthetic parchment shade



Pantalla de lino marrón  
Brown linen shade

## Adaptador carril / Rail adapter

- B17P-X33X2B-01
- B17P-X33X2B-02
- B17P-X33X2B-03



p.387







# NATURAL

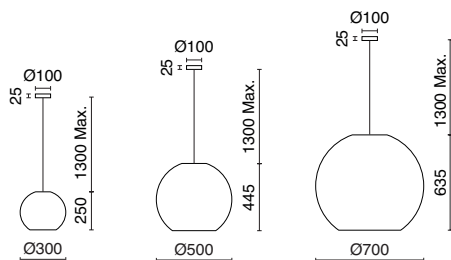

**Ø300**  
E27 Led max. 15W

- 1029A-G05X1A-02-M1
- 1029A-G05X1A-02-M2

**Ø500**  
E27 Led max. 15W

- 1029B-G05X1A-02-M1
- 1029B-G05X1A-02-M2

**Ø700**  
E27 Led max. 15W

- 1029C-G05X1A-02-M1
- 1029C-G05X1A-02-M2

IP  
20

- 1029D-G05X1A-02-M1
- 1029D-G05X1A-02-M2

- 1029E-G05X1A-02-M1
- 1029E-G05X1A-02-M2

- 1029F-G05X1A-02-M1
- 1029F-G05X1A-02-M2

IP  
65



Acabado negro con pantalla de mimbre claro o mimbre oscuro / Black finish with screen light wicker or dark wicker Lamps p.791

## Adaptador carril / Rail adapter

- B17P-X33X2B-01
- B17P-X33X2B-02
- B17P-X33X2B-03





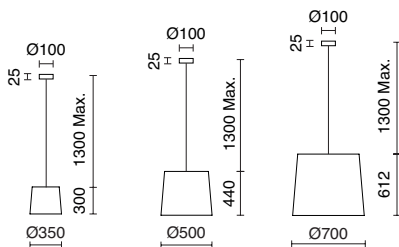

### Ø350

E27 Led max. 15W

■ 985A-G05X1A-02-R1

■ 985D-G05X1A-02-R1

### Ø500

E27 Led max. 15W

■ 985B-G05X1A-02-R1

■ 985E-G05X1A-02-R1

### Ø700

E27 Led max. 15W

■ 985C-G05X1A-02-R1

■ 985F-G05X1A-02-R1

IP 20

IP 65



Florón negro con pantalla de raphia de Bali / Black finish with raphia de Bali shade

Lamps p.791

### Adaptador carril / Rail adapter

- B17P-X33X2B-01
- B17P-X33X2B-02
- B17P-X33X2B-03



Fabricado con materiales susceptibles a variaciones de color y trama.  
Made with materials susceptible to variations in color and pattern.





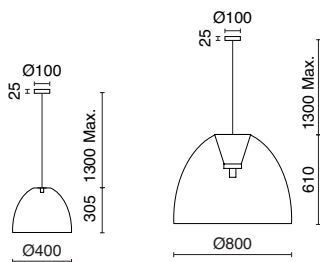





## Ø400

E27 Led max. 15W

-  1037A-G05X1A-02-M1
-  1037A-G05X1A-02-M2

## Ø800

E27 Led max. 15W

-  1037B-G05X1A-02-M1
-  1037B-G05X1A-02-M2

IP 20

-   1037C-G05X1A-02-M1
-   1037C-G05X1A-02-M2

IP 65



Acabado negro con pantalla de mimbre claro o mimbre oscuro / Black finish with screen light wicker or dark wicker

### Adaptador carril / Rail adapter

- B17P-X33X2B-01
- B17P-X33X2B-02
- B17P-X33X2B-03



Lamps p.791



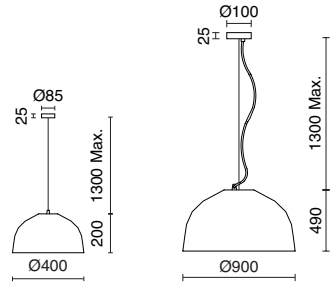
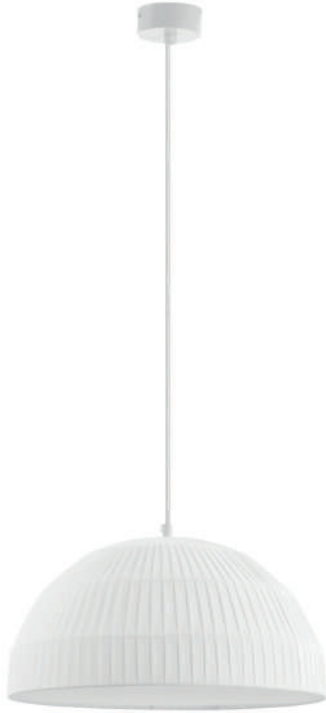

**Ø400**

E27 Led max. 15W

□ ○ 1030A-G05X1A-01-RA

**Ø900**

3x E27 Led max. 15W

□ ○ 1030B-G05X1A-01-RA



Acabado blanco / White finish

Lamps p.791

*Posibilidad de customizar el acabado / Possibility to customise the finish*

**Adaptador carril / Rail adapter**

- B17P-X33X2B-01
- B17P-X33X2B-02
- B17P-X33X2B-03





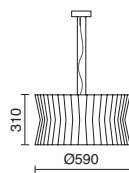

3x E27 Led/Fluo/Hal max. 60W

- 859A-G05X1A-35-RA
- 859A-G05X1A-35-RB
- 859A-G05X1A-35-RC



Acabado blanco, negro o beige / White, black or beige finish

Lamps p.791







E27 Led / Fluo / Hal max. 60W

- 507G-G05X1A-09
- 507G-G05X1A-29

ACER



Suspensión beige o transparente con pantalla blanca, negra o beige  
Beige or transparent pendant with white, black or beige shade

Lamps p.791

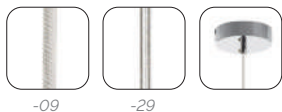

Accesorio necesario / Necessary accessory

PANTALLAS / SHADES

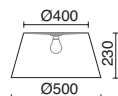

- A32A-004-CA
- A32A-004-CB
- A32A-004-CC

COTTON

Adaptador carril / Rail adapter

- B17P-X33X2B-01
- B17P-X33X2B-02
- B17P-X33X2B-03



p.285



p.286



p.398



p.399





908C-



908A-



908B-



### Ø300mm

LED COB AC 12W 1030lm 3000K

- 908A-L0112B-RA
- 908A-L0112B-RB
- 908A-L0112B-RC

### Ø600mm

LED SMD 25W 3540lm 3000K

- 908B-L0125B-RA
- 908B-L0125B-RB
- 908B-L0125B-RC

### Ø900mm

LED SMD 29W 4000lm 3000K

- 908C-L0129B-RA
- 908C-L0129B-RB
- 908C-L0129B-RC



Acabado pantalla Ribbon wrapped white, black o beige / Screen finish White, black or beige wrapped tape

Possibilidad de customizar el acabado  
Possibility to customise the finish



# VORADA

PENDANT LAMPS



h max. 1500mm

908F-

908D-



908E-

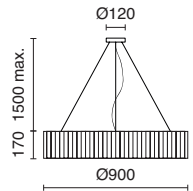
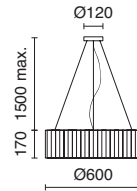
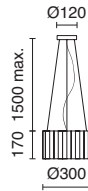

Ø300mm

LED COB AC 12W 1030lm 3000K

- 908D-L0112B-RA
- 908D-L0112B-RB
- 908D-L0112B-RC

Ø600mm

LED SMD 25W 3540lm 3000K

- 908E-L0125B-RA
- 908E-L0125B-RB
- 908E-L0125B-RC

Ø900mm

LED SMD 29W 4000lm 3000K

- 908F-L0129B-RA
- 908F-L0129B-RB
- 908F-L0129B-RC



Acabado pantalla Ribbon wrapped white, black o beige / Screen finish White, black or beige wrapped tape

Posibilidad de customizar el acabado  
Possibility to customise the finish





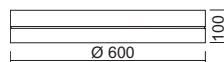
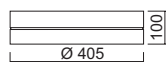

### Ø405

LED SMD 30W 3316lm 3000K

- 1077A-L3132B-01-02
- 1077A-L3132B-01-47
- 1077A-L3132B-01-T1

### Ø600

LED SMD 36W 3980lm 3000K

- 1077B-L3144B-01-02
- 1077B-L3144B-01-47
- 1077B-L3144B-01-T1



Acabado blanco con interior negro, oro o trama / White finish with interior black, gold or pattern

Trama decorativa interior personalizable / Customisable interior decorative pattern





# FRED

PENDANT & CEILING LAMPS

*h max. 1500mm*

715A-L0125A-01 + A20A-715-01

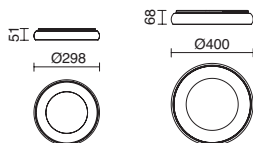

**Ø298**

LED SMD 25W 1850lm 3000K

- 715A-L0125A-01
- 715A-L0125A-02
- 715A-L0125A-03

**Ø400**

LED SMD 35W 2940lm 3000K

- 715B-L3135A-01
- 715B-L3135A-02
- 715B-L3135A-03



Acabado blanco, negro o gris / White, black or grey finish

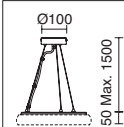

Accesorio necesario para suspensión  
Necessary accessory for pendant

- A20A-715-01
- A20A-715-02
- A20A-715-03



Accesorio decorativo opcional para superficie  
Optional decorative accessory for surface

- Ø298
- Ø400
- A20B-715-01
- A20C-715-01





Accesorio necesario / Necessary accessory

## PANTALLAS / SHADES

- A32B-004-CA
- A32B-004-CC
- A32B-004-CK
- A32B-004-CJ
- A32B-004-CE
- A32B-004-HC



- A32C-004-CA
- A32C-004-CC
- A32C-004-CK
- A32C-004-CJ
- A32C-004-CE
- A32C-004-HC

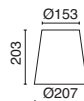

- A32D-004-CA
- A32D-004-CC
- A32D-004-CK
- A32D-004-CJ
- A32D-004-CE
- A32D-004-HC

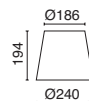

Pantalla de algodón blanco, beige, gris, rojo, capuccino o yute beige / White, beige, grey, red, cappuccino or beige jute cotton shade



# A TU ESTILO

PENDANT LAMPS

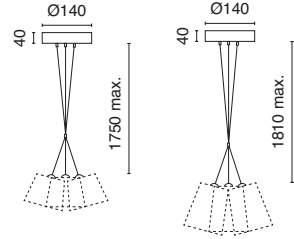
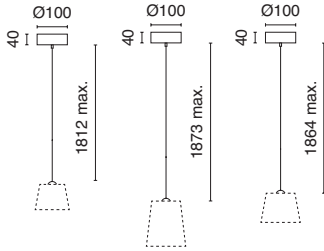

E27 Led / Fluo / Hal max. 60W

3x E27 Led / Fluo / Hal max. 60W

- 716A-G05X1A-03
- 716A-G05X1A-07
- 716A-G05X1A-09
- 716A-G05X1A-29

- 716B-G05X1A-03
- 716B-G05X1A-07
- 716B-G05X1A-09
- 716B-G05X1A-29

Cable gris, rojo, beige o transparente / Grey, red, beige or transparent cable

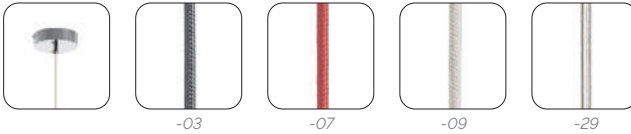

Adaptador carril  
Rail adapter



- B17P-X33X2B-01
- B17P-X33X2B-02
- B17P-X33X2B-03

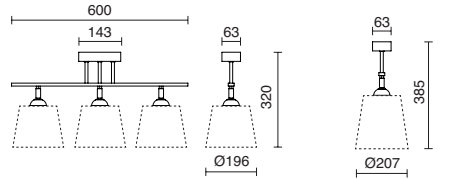

3x E27 Led / Fluo / Hal max. 60W

- 717G-G05X1A-02
- 717G-G05X1A-03



ACER



Acabado negro o gris / Black or grey finish

Lamps p.791







685A-



685B-

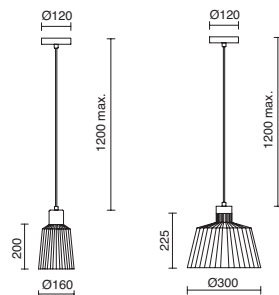

**Ø160**

E27 Led / Fluo / Hal max. 42W

■ 685A-G05X1A-02

**Ø300**

E27 Led / Fluo / Hal max. 42W

■ 685B-G05X1A-02

ACER + WOOD



Acabado negro / Black finish

Lamps p.791

Adaptador carril / Rail adapter

- B17P-X33X2B-01
- B17P-X33X2B-02
- B17P-X33X2B-03



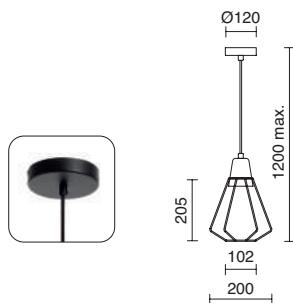

E27 Led / Fluo / Hal max. 60W

■ 684A-G05X1A-02

ACER + WOOD



Acabado negro / Black finish

Lamps p.791

Adaptador carril / Rail adapter

- B17P-X33X2B-01
- B17P-X33X2B-02
- B17P-X33X2B-03



# A TU ESTILO

PENDANT LAMPS

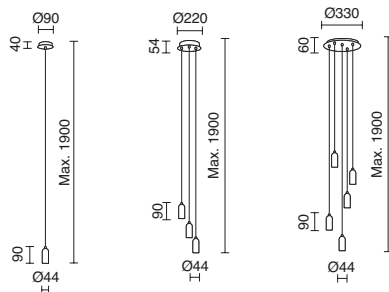

**1x E27 Led / Vintage max. 60W**

- 717D-G05X1A-01
- 717D-G05X1A-02
- 717D-G05X1A-32

**3x E27 Led / Vintage max. 60W**

- 717E-G05X1A-01
- 717E-G05X1A-02
- 717E-G05X1A-32

**5x 27 Led / Vintage max. 60W**

- 717F-G05X1A-01
- 717F-G05X1A-02
- 717F-G05X1A-32

ACER



Acabado blanco, negro o cromo / White, black or chrome finish

Lamps p.791







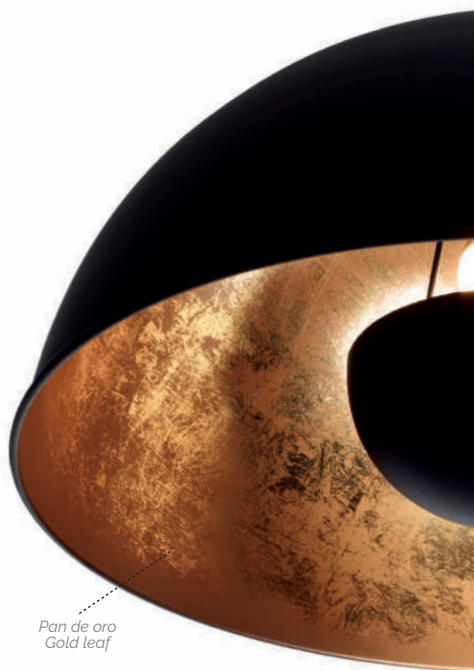

Pan de oro  
Gold leaf

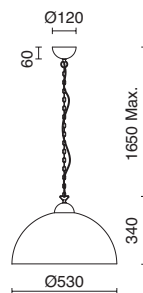

E27 Led / Fluó / Hal max. 60W

■ 618A-G05X1A-02

ACER



Acabado negro / Black finish

Lamps p.791

Adaptador carril / Rail adapter

- B17P-X33X2B-01
- B17P-X33X2B-02
- B17P-X33X2B-03







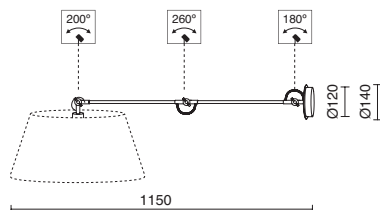

E27 (Led / Fluo / Hal) max. 60W

■ 595A-G05X1A-35

ACER



Brazo de níquel satinado con pantalla ribbon wrapped white, black o beige  
Satin nickel arm finish with white, black or beige ribbon wrapped shade

Lamps p.791

Accesorio necesario / Necessary accessory

**PANTALLAS / SHADES**

---

- A32A-004-CA
- A32A-004-CB
- A32A-004-CC

COTTON





E27 Led / Fluo / Hal. max. 60W

■ 620A-G05X1A-02

■ 585A-G05X1A-02

ACER



Acabado negro / Black finish

Lamps p.791

Adaptador carril / Rail adapter

- B17P-X33X2B-01
- B17P-X33X2B-02
- B17P-X33X2B-03





# Floor & table lamps





1075A-



1075B-



1075C-

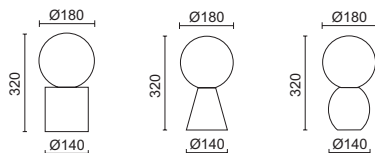

□ G9 LED Max. 5W

□ 1075A-H20X1A-01

■ 1075A-H20X1A-50

△ G9 LED Max. 5W

□ 1075B-H20X1A-01

■ 1075B-H20X1A-50

○ G9 LED Max. 5W

□ 1075C-H20X1A-01

■ 1075C-H20X1A-50



Acabado blanco o madera haya / White or beech wood finish

Lamps p. 792







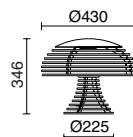

GX53 LED T2 10W 1200lm 3000K

1073A-L3110A-50

WOOD



Acabado madera haya / Beech wood finish

p.267



p.315





# TWIST

BY NACHO TIMÓN



945B-



945A-



945E-

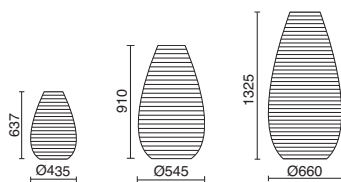

## h637

GX53 LED T2 10W 1200lm 3000K

■ 945A-L3110A-50

## h910

GX53 LED T2 18W 1200lm 3000K

■ 945E-L3111A-50

## h1325

GX53 LED T2 18W 2000lm 3000K

■ 945B-L3111A-50



Acabado madera haya / Beech wood finish

p.321





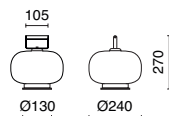

LED SMD AC 10W 830lm 2700K

- 1028K-L38RCB-02-FG
- 1028K-L38RCB-02-05
- 1028K-L38RCB-02-06



Acabado negro con cristal fougé, verde o azul / Black finish with fougé, green or blue glass







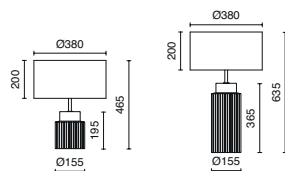

**h465**

E27 Led max. 15W

- ○ 1033B-G05X1A-01-CA
- ● 1033B-G05X1A-02-CK
- ● 1033B-G05X1A-47-SG

**h635**

E27 Led max. 15W

- ○ 1033C-G05X1A-01-CA
- ● 1033C-G05X1A-02-CK
- ● 1033C-G05X1A-47-SG



Acabado blanco, negro o dorado con pantalla Cotton White, Cotton Grey o Synthetic Gold  
White, black or gold finish with Cotton White, Cotton Grey or Synthetic Gold shade

Lamps p.791







LED SMD AC 4W 400lm 3000K

- 906G-L3104B-01
- 906G-L3104B-02
- 906G-L3104B-37
- 906G-L3104B-47

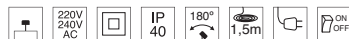

Acabado blanco, negro, cobre o oro / Finished in white, black, copper or gold







1014C-



1014D-

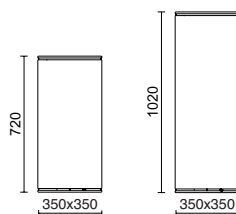

**h720**  
2x LED T8 9W 3000K

- ○ 1014C-L3109B-02
- ● 1014C-L3109B-02-SC

**h1020**  
2x LED T8 14W 3000K

- ○ 1014D-L3114B-02
- ● 1014D-L3114B-02-SC



Acabado negro / Black finish



*Pantalla de pergamino sintético*  
Synthetic parchment shade



*Pantalla de lino marrón*  
Brown linen shade



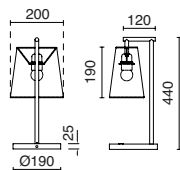

E27 Led / Fluo / Hal max. 40W

- 1017B-G05X1A-01-D1
- 1017B-G05X1A-01-D2
- 1017B-G05X1A-01-D3
- 1017B-G05X1A-02-D4

- 1017D-G05X1A-01-D1
- 1017D-G05X1A-01-D2
- 1017D-G05X1A-01-D3
- 1017D-G05X1A-02-D4



Pie blanco o negro con pantalla tejido sintético blanco, beige, marrón o negro fabric  
 White or black body finish with synthetic white, beige, brown, beige or black fabric shade finish

Lamps p.791





E27 Led / Fluo / Hal max. 40W

- 1017C-G05X1A-01-D1
- 1017C-G05X1A-01-D2
- 1017C-G05X1A-01-D3
- 1017C-G05X1A-02-D4



Pie blanco o negro con pantalla tejido sintético blanco, beige, marrón o negro fabric  
 White or black body finish with synthetic white, beige, brown, beige or black fabric shade finish

Lamps p.791





**Ø350**  
E27 Led max. 13W (Ø45)

- ○ 855C-G05X1A-01-SA
- ● 855C-G05X1A-02-SB
- ● 855C-G05X1A-37-SM

**Ø450**  
E27 Led max. 13W

- ○ 855B-G05X1A-01-SA
- ● 855B-G05X1A-02-SB
- ● 855B-G05X1A-37-SM



Acabado blanco, negro o cobre / White, black or copper finish

Lamps p.791

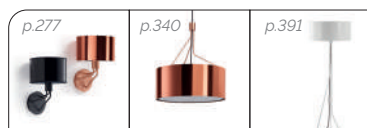



# DIAGONAL

BY NACHO TIMÓN

FLOOR & TABLE LAMPS



E27 Led max. 13W

□○ 855A-G05X1A-01-SA

●● 855A-G05X1A-02-SB

●● 855A-G05X1A-37-SM

ACER + (SYNT) + PVC



Acabado blanco, negro o cobre / White, black or copper finish

Lamps p.791

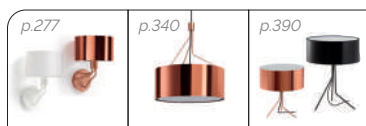



Nuevo acabado  
New finish

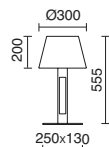

E27 Led/Fluo/Hal max. 60W

○ 986B-G05X1A-35-CA

● 986B-G05X1A-47-CB



Acabado níquel satinado o dorado con pantalla ribbon wrapped blanca o wrapped negra  
Satin nickel or gold finish with white ribbon wrapped or black ribbon wrapped shade

Lamps p.791







E27 Led/Fluo/Hal. max. 60W

- 986C-G05X1A-35-CA
- 986C-G05X1A-47-CB

*Nuevo acabado de pintura  
New colour finish*



*Acabado níquel satinado o dorado con pantalla ribbon wrapped blanca o wrapped negra  
Satin nickel or gold finish with white ribbon wrapped or black ribbon wrapped shade*

*Lamps p.791*



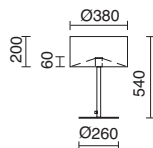

E27 Led / Fluo / Hal| max. 40W

□ 909B-G05X1A-01

■ 909B-G05X1A-02

ACER



Acabado blanco o negro con pantalla blanca, negra o marrón  
Black or white finish with white, black or brown shade

Lamps p.791

Accesorio necesario / Necessary accessory

## PANTALLAS / SHADES



- A29C-004-CA
- A29C-004-CB
- A29C-004-CG



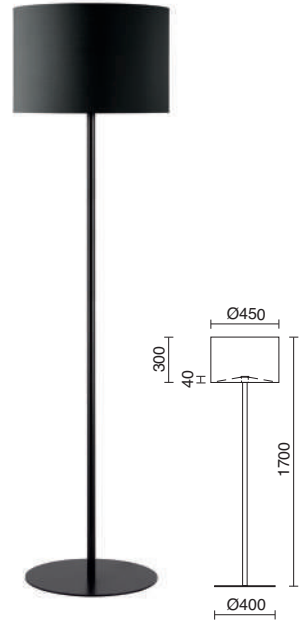

E27 Led / Fluo / Hall max. 40W

□ 909A-G05X1A-01

■ 909A-G05X1A-02



Acabado blanco o negro con pantalla blanca, negra o marrón  
Black or white finish with white, black or brown shade

Lamps p.791

Accesorio necesario / Necessary accessory

## PANTALLAS / SHADES

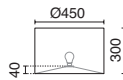

- A29B-004-CA
- A29B-004-CB
- A29B-004-CG



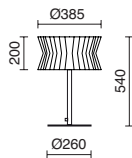

E27 (Led/Fluo/Hal max. 40W (Ø45))

□ ○ 859C-G05X1A-01-RA

■ ● 859C-G05X1A-02-RB



Acabado blanco o negro / White or black finish

Lamps p.791



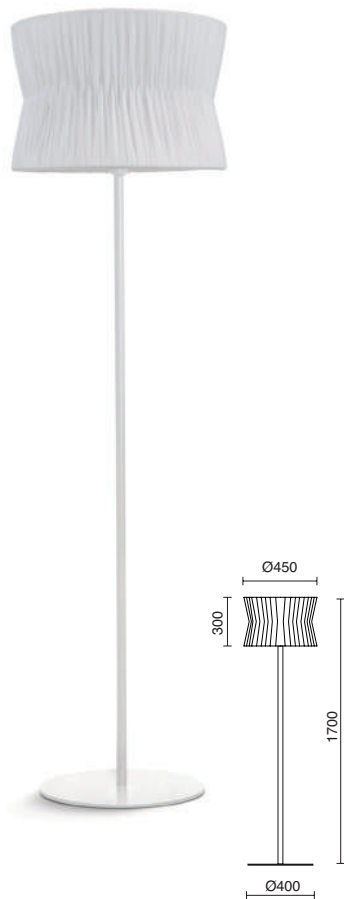

E27 Led/Fluo/Hal max. 60W

□ ○ 859B-G05X1A-01-RA

■ ● 859B-G05X1A-02-RB



Acabado blanco o negro / White or black finish

Lamps p.791



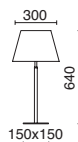

E27 Led / Fluo / Hal max. 60W

● 507D-G05X1A-35



Acabado níquel satinado con pantalla blanca, negra o beige  
Satin nickel finish with white, black or beige shade

Lamps p.791

Accesorio necesario / Necessary accessory

## PANTALLAS / SHADES



- A26B-004-CA
- A26B-004-CB
- A26B-004-CC

- A27B-004-CA
- A27B-004-CB
- A27B-004-CC



p.285



p.286



p.353



p.399



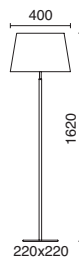
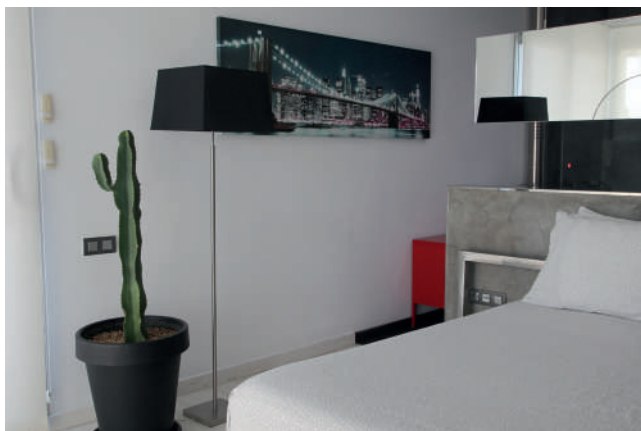

E27 Led / Fluo / Hal max. 60W

● 507C-G05X1A-35

ACER



Acabado níquel satinado con pantalla blanca, negra o beige  
Satin nickel finish with white, black or beige shade

Lamps p.791

Accesorio necesario / Necessary accessory

## PANTALLAS / SHADES

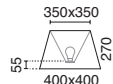
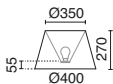

- A26C-004-CA
- A26C-004-CB
- A26C-004-CC

- A27C-004-CA
- A27C-004-CB
- A27C-004-CC

COTTON

p.285



p.286



p.353



p.398



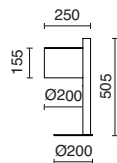

E27 Led / Fluo / Hal max. 40W (Ø45)

- 621D-G05X1A-50-CA
- 621D-G05X1A-50-DC
- 621D-G05X1A-50-CG



Acabado madera de haya con pantalla cotton white, eco beige o cotton earth  
Beech wood finish with cotton white, eco beige or cotton earth shade

Lamps p.791





# COMPACT

FLOOR & TABLE LAMPS

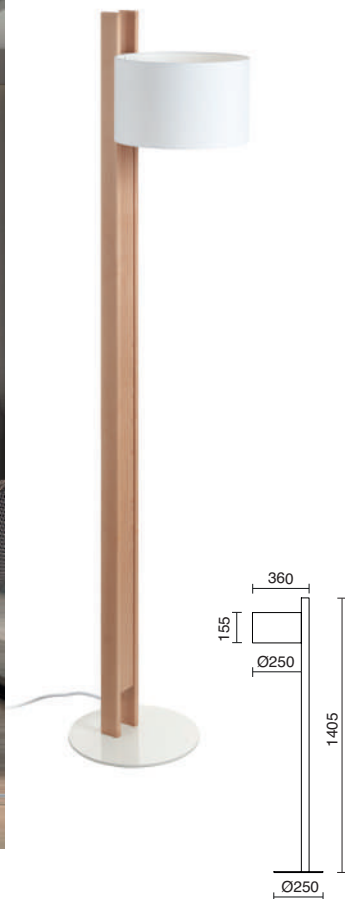

E27 Led / Fluo / Hal max. 40W

- 621E-G05X1A-50-CA
- 621E-G05X1A-50-DC
- 621E-G05X1A-50-CG



Acabado madera de haya con pantalla cotton white, eco beige o cotton earth  
Beech wood finish with cotton white, eco beige or cotton earth shade

Lamps p.791



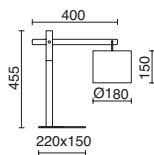

E27 Led / Fluo / Hal max. 60W

■ 681B-G05X1A-02



Acabado negro con pantalla cotton white/ Black finish with cotton white shade

Lamps p.791

	Accesorio necesario Necessary accessory	
	<b>PANTALLA / SHADE</b>	<b>Ø180</b>
○ A35C-004-CA		





E27 Led / Fluo / Hal max. 60W

■ 681C-G05X1A-02



Acabado negro con pantalla cotton white / Black finish with cotton white shade

Lamps p.791

	Accesorio necesario Necessary accessory	
	<b>PANTALLA / SHADE</b>	
○ A35A-004-CA		







E27 Led / Fluo / Hal max. 60W

845B-G05X1A-50



845A-G05X1A-50



WOOD



Pie de madera de haya con pantalla cotton white o eco beige  
Beech wood finish with cotton white or eco beige shade

Lamps p.791

Accesorio necesario / Necessary accessory

## PANTALLAS / SHADES

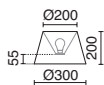

- A26B-004-CA
- A26B-004-CC

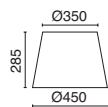

- A26G-004-CA
- A26G-004-CC







E27 Led / Fluo / Hal max. 60W

■ 621B-G05X1A-50



■ 621A-G05X1A-50



Pie de madera de haya con pantalla cotton white, eco beige o cotton earth  
 Beech wood finish with cotton white, eco beige or cotton earth shade

Lamps p.791

Accesorio necesario / Necessary accessory

PANTALLAS / SHADES			
○ A29C-004-CA	● A29C-004-DC	● A29C-004-CG	
○ A29B-004-CA	● A29B-004-DC	● A29B-004-CG	

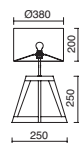

E27 Led / Fluo / Hal max. 40W

■ 703B-G05X1A-02

■ 703B-G05X1A-50



Pie de madera de haya con pantalla cotton white, negra, eco beige o cotton earth  
Beech wood finish with cotton white, black, eco beige or cotton earth shade

Lamps p.791

Accesorio necesario / Necessary accessory

**PANTALLAS / SHADES**

○ A29C-004-CA  
● A29C-004-CB  
● A29C-004-DC  
● A29C-004-CG





E27 Led / Fluo / Hal max. 60W

- 703A-G05X1A-02
- 703A-G05X1A-50

WOOD + ACER



Pie de madera de haya con pantalla cotton white, negra, eco beige o cotton earth  
Beech wood finish with cotton white, black, eco beige or cotton earth shade

Lamps p.791

Accesorio necesario / Necessary accessory

**PANTALLAS / SHADES**

- A29B-004-CA
- A29B-004-CB
- A29B-004-DC
- A29B-004-CG

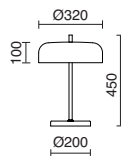

2x E27 (Ø45) Led / Fluo / Hal max. 40W

□ 992A-G04X1A-01

■ 992A-G04X1A-02



Acabado blanco o negro / White or black finish

Lamps p.791

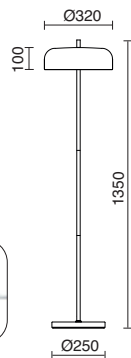

2x E27 (Ø45) Led / Fluo / Hal. max. 40W

□ 992B-G04X1A-01

■ 992B-G04X1A-02



Acabado blanco o negro / White or black finish

Lamps p.791

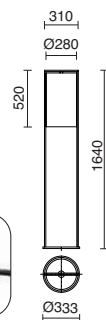
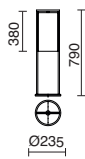

**h790**  
E27 Led / Fluo / Hal max. 40W

■ ○ 917B-G05X1A-02-CA

**h1640**  
E27 Led / Fluo / Hal max. 60W

■ ○ 917A-G05X1A-02-CA



Acabado negro con pantalla cotton white / Black finish with cotton white shade

Lamps p.791

# ZANZIBAR

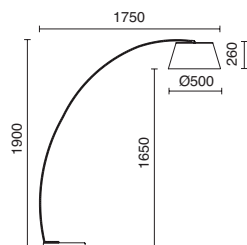

E27 Led / Fluo / Hal max. 42W

■ 622A-G05X1A-02



Acabado negro / Black finish

Lamps p.791

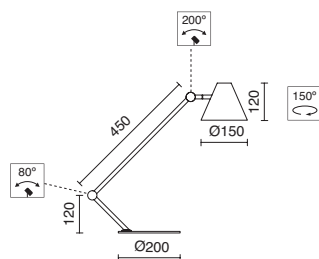

E27 (Ø45) Led / Fluo / Hal max. 40W

□ 990A-G04X1A-01



Acabado blanco / White finish

Lamps p.791



E27 Led / Fluo / Hal max. 60W (Ø45)

- 846C-G05X1A-O1
- 846C-G05X1A-MK
- 846C-G05X1A-BL

- N □ 846D-G05X1A-O1
- N ■ 846D-G05X1A-MK
- N ■ 846D-G05X1A-BL



Acabado blanco, moka o azul claro / White, mocha or light blue finish

Lamps p.791





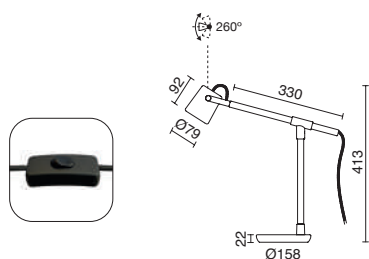

GU10 Led max. 9W

■ 1012A-G21X1A-02-51



Acabado negro / Black finish

Lamps p.791



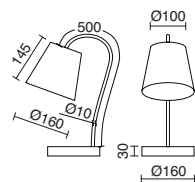

E27 Led / Fluo / Hal max. 60W (Ø45)

●● 907A-G05X1A-02-CB



Acabado negro / Black finish

Lamps p.791

p.222





Bath  
lights

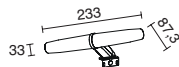

LED SMD AC 6W 392lm 4000K

973A-L0206B-32



Acabado cromo / Chrome finish



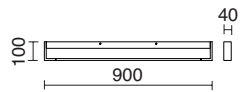
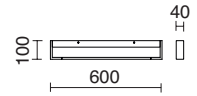
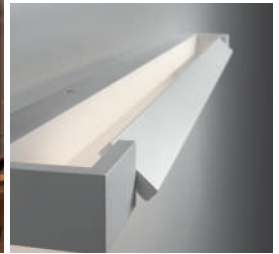

**L600**  
LED SMD 18W 2165lm 4000K

- 959A-LO218B-01
- 959A-LO218B-02

**L900**  
LED SMD 30W 3745lm 4000K

- 959B-LO230B-01
- 959B-LO230B-02



Acabado blanco o negro / Black or white finish





971C-



971B-



971A-

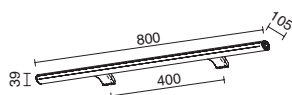
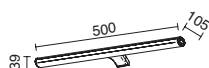

### L300

LED SMD AC **7W** 637lm 4000K

■ 971A-L0207B-32

### L500

LED SMD AC **9W** 919lm 4000K

■ 971B-L0209B-32

### L800

LED SMD AC **10W** 1052lm 4000K

■ 971C-L0210B-32



Acabado cromo / Chrome finish





972D-



972E-

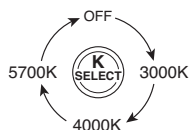

3 temperaturas de color con pulsación directa, sin memoria

3 color temperatures with direct pulse, no memory



## Montaje a pared / Assembling to wall

LED SMD AC 6W

LED SMD AC 8W

▣ 972D-L4106B-32

▣ 972E-L4108B-32

K SELECT	3000K	408lm	
	4000K	473lm	
	5700K	474lm	

K SELECT	3000K	545lm	
	4000K	614lm	
	5700K	633lm	

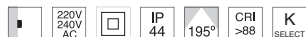

Acabado cromo / Chrome finish





972A-



972B-



972C-

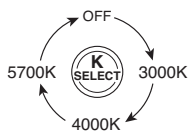

3 temperaturas de color con pulsación directa, sin memoria  
3 color temperatures with direct pulse, no memory

## Montaje con espejo / With mirror assembling

LED SMD AC 6W

972A-L4106B-32

K SELECT	3000K	408lm
	4000K	473lm
	5700K	474lm

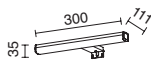

LED SMD AC 8W

972B-L4108B-32

K SELECT	3000K	545lm
	4000K	614lm
	5700K	633lm

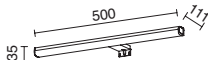

LED SMD AC 12W

972C-L4112B-32

K SELECT	3000K	817lm
	4000K	948lm
	5700K	949lm

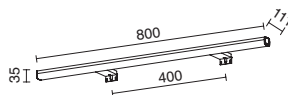

Acabado cromo / Chrome finish





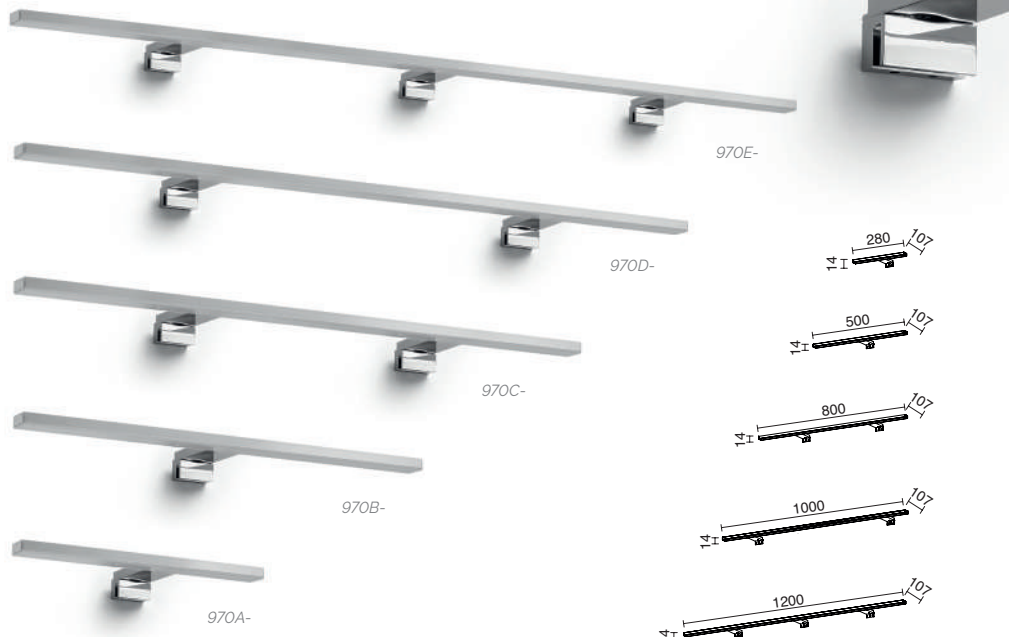

**L280**  
LED SMD AC **6W** 457lm 4000K

■ 970A-LO206B-32

**L500**  
LED SMD AC **8W** 568lm 4000K

■ 970B-LO208B-32

**L800**  
LED SMD AC **10W** 720lm 4000K

■ 970C-LO210B-32

**L1000**  
LED SMD AC **15W** 1265lm 4000K

■ 970D-LO215B-32

**L1200**  
LED SMD AC **18W** 1532lm 4000K

■ 970E-LO218B-32



Acabado cromo / Chrome finish



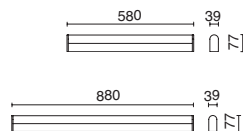

**L580**  
LED SMD 12W 720lm 3000K

**L880**  
LED SMD 18W 1883lm 3000K

513A-L0109B-32

513B-L0118B-32



Acabado cromo / Chrome finish

# LITS

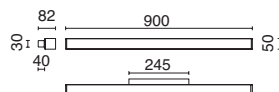
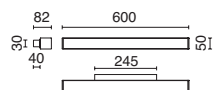

**L600**  
LED SMD 9W 960lm 3000K

**L900**  
LED SMD 12W 1883lm 3000K

514A-L0109B-32

514B-L0112B-32



Acabado cromo / Chrome finish

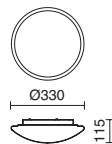

2x E27 [Led / Fluo] max. 23W

■ 500A-G05X1A-32



Acabado cromo / Chrome finish

Lamps p. 721



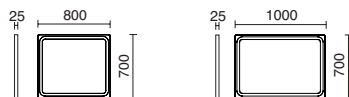

**L800**  
LED SMD 20W 744lm 4000K

■ 974A-LO220B-32

**L1000**  
LED SMD 20W 744lm 4000K

■ 974B-LO220B-32

*Antivaho 21W / Anti-fog 21W*

**L800**  
LED SMD 20W 744lm 4000K

■ 974C-LO220B-32

**L1000**  
LED SMD 20W 744lm 4000K

■ 974D-LO220B-32

*Antivaho 29W / Anti-fog 29W*

Luz Light   
Antivaho Anti-buée 



PC + ABS + GLASS + PVC 

    

*Acabado cromo / Chrome finish*

- Dos posiciones de instalación 90° / Two positions of installation 90°  
- Contorno del espejo con tratamiento antióxido / Mirror edge with anticorrosion treatment





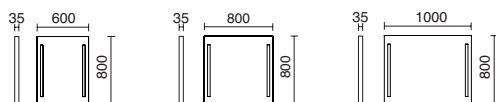

**L600**  
LED SMD 2x10W 600lm 4000K

975A-L0220B-32

**L800**  
LED SMD 2x10W 600lm 4000K

975B-L0220B-32

**L1000**  
LED SMD 2x10W 600lm 4000K

975C-L0220B-32



Acabado cromo / Chrome finish



# Ceiling fans



# MISTRAL N



CEILING FAN

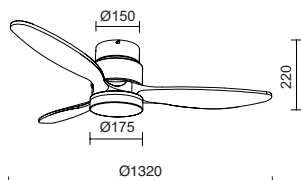

LED SMD 24W  
35W max. (139/150/179/185/213/225 rpm)

- 1074B-W4135B-01-01
- 1074B-W4135B-01-57
- 1074B-W4135B-01-59

- 1074B-W4135B-02-02
- 1074B-W4135B-02-57
- 1074B-W4135B-02-59

<b>K</b> SELECT	2700K	1420lm
	3200K	1480lm
	4000K	1500lm



Acabado blanco o negro con aspas de madera blanca, negra, arce o nogal  
Black or white finish with white, black, maple or walnut wood blades

Max. 235m<sup>3</sup>/min.  
Max. 48dB

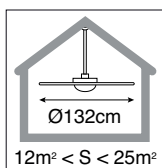
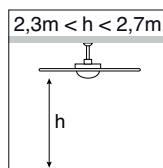

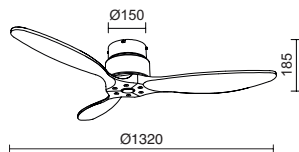

35W max. (139/150/179/185/213/225 rpm)

- |  |   |
|--|---|
| <input type="checkbox"/> <input type="checkbox"/> 1074A-VX35B-01-01            | <input checked="" type="checkbox"/> <input checked="" type="checkbox"/> 1074A-VX35B-02-02 |
| <input type="checkbox"/> <input checked="" type="checkbox"/> 1074A-VX35B-01-57 | <input checked="" type="checkbox"/> <input checked="" type="checkbox"/> 1074A-VX35B-02-57 |
| <input type="checkbox"/> <input checked="" type="checkbox"/> 1074A-VX35B-01-59 | <input checked="" type="checkbox"/> <input checked="" type="checkbox"/> 1074A-VX35B-02-59 |



Acabado blanco o negro con aspas de madera blanca, negra, arce o nogal  
Black or white finish with white, black, maple or walnut wood blades

Max. 235m<sup>3</sup>/min.  
Max. 48dB

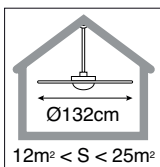
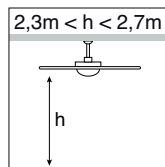

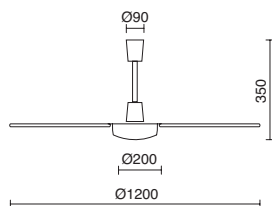

22,6W-195rpm / 32,2W-256rpm / 39,2W-290rpm / 43,7W-307rpm / 60W-330rpm

□ 638A-VX60B-01



Acabado blanco / White finish

Regulador de pared incluido / Wall regulator included

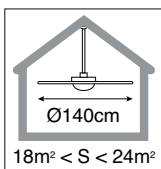
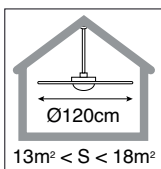
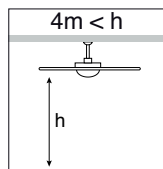

RESIDENT  
OUTDOOR



TIAL  
OR

**Dopo**  
lighting



# Wall lights & Downlights

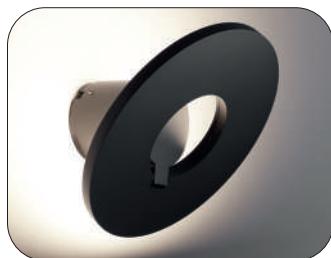
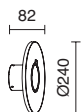

LED SMD 8W 1300lm 3000K

■ 1054A-L3110B-04



Acabado antracita / Anthracite finish

p.535





1034A-



1034B-

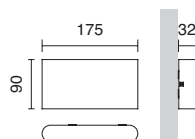
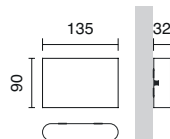

### L135

LED SMD 2x 2,5W

1034A-L4106B-01

1034A-L4106B-02

### L175

LED SMD 2x 4W

1034B-L4110B-01

1034B-L4110B-02

K <small>SELECT</small>	2700K	370lm
	3200K	410lm
	4000K	430lm

K <small>SELECT</small>	2700K	525lm
	3200K	600lm
	4000K	700lm



Acabado blanco o negro / White or black finish



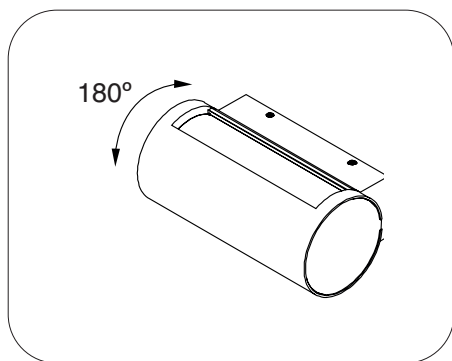
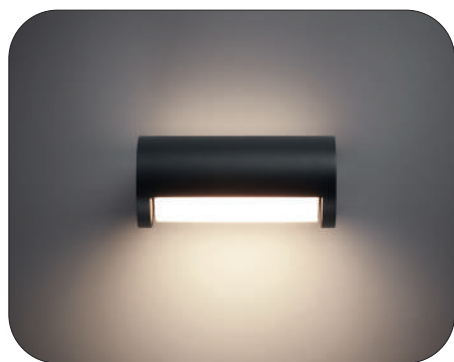
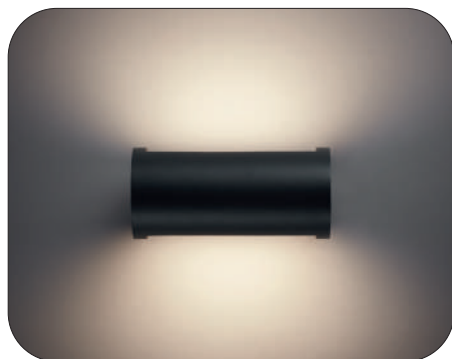
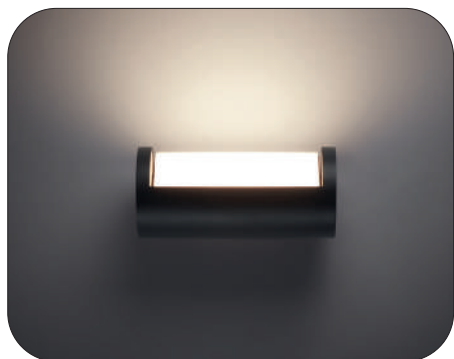
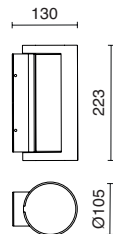
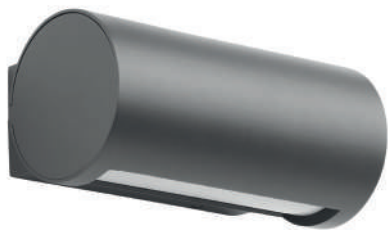

LED SMD 11W 1500lm 3000K

■ 1050A-L3113B-04



Acabado antracita / Anthracite finish

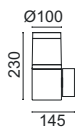

LED SMD 7W

■ 1072A-L4108BBF-02

K SELECT	3000K	7901lm
	4000K	8451lm



Acabado negro / Black finish





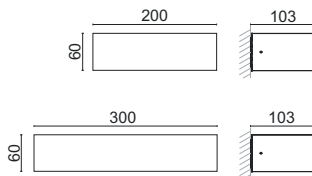

LED SMD **9W**

■ 1071A-L4110BBF-02

K SELECT	2700K	1230lm
	3200K	1350lm
	4000K	1550lm

LED SMD **14W**

■ 1071B-L4115BBF-02

K SELECT	2700K	1830lm
	3200K	1950lm
	4000K	2140lm



Acabado negro / Black finish



Imitación madera  
Wood imitation

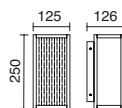

LED SMD 6.5W 1020lm 3000K

■ 1027A-L3107BX0-04



Acabado antracita / Anthracite finish

p.538





E27 Led/Fluo 18W max.

□ 1015A-G05X1A-01

■ 1015A-G05X1A-04

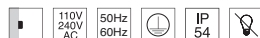

Acabado blanco o antracita / White or anthracite finish

Lamps p.791

p.539



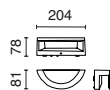

**3000K**  
LED SMD 9,5W 1295lm

■ 982A-L3109A-02

**4000K**  
LED SMD 9,5W 1405lm

■ 982A-L3309A-02



Acabado negro / Black finish

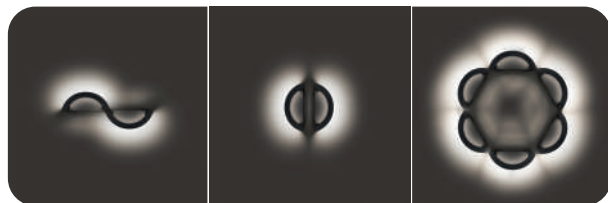

# BUCKET

WALL LIGHTS

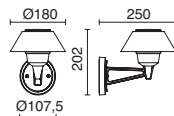

**3000K**  
LED SMD 10,5W 1680lm

■ 976A-L3110B-04

■ 976A-L31RCB-04

**4000K**  
LED SMD 10,5W 1770lm

■ 976A-L3310B-04

■ 976A-L33RCB-04



Acabado antracita / Anthracite finish



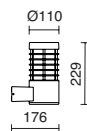

E27 Led/Fluo 15W max.

■ 1016A-G05X1A-04



Acabado antracita / Anthracite finish

Lamps p.791





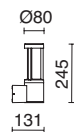

LED SMD 10W 1300lm 3000K

■ 848A-L0109A-04

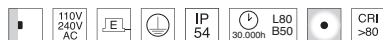

Acabado antracita / Anthracite finish



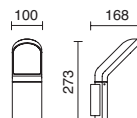

LED SMD 10W 1200lm 3000K

■ 534A-LO109A-04

110V  
240V  
AC

■ 534C-LO109B-04



220V  
240V  
AC



*Regulación de:*  
 - Distancia: 0>8 m.  
 - Tiempo de activación: de 5 seg. a 8 min.  
 - Intensidad de la luz: 10 - 2000lux  
 - Ángulo de detección: 100°

*Adjustable:*  
 - Distance: 0>8 m.  
 - Activation time: from 5 sec. to 8 min.  
 - Light intensity: 10 - 2000lux  
 - Detection angle: 100°



Acabado antracita / Anthracite finish





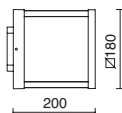

LED COB 12W 1300lm 3000K

■ 791A-L0112A-04

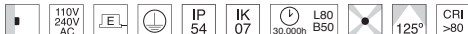

Acabado antracita / Anthracite finish

p.550



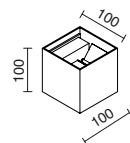

LED COB 2x 3W 290lm 3000K

- 960A-L3106B-01
- 960A-L3106B-02
- 960A-L3106B-04
- 960A-L3106B-90

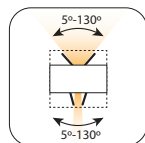

Acabado blanco, negro, antracita o marrón óxido / White, black, anthracite or oxide brown finish

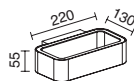

LED COB 7W 448lm 3000K

■ 443A-L0107A-04



Acabado antracita / Anthracite finish

# FROST

WALL LIGHTS

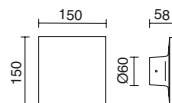
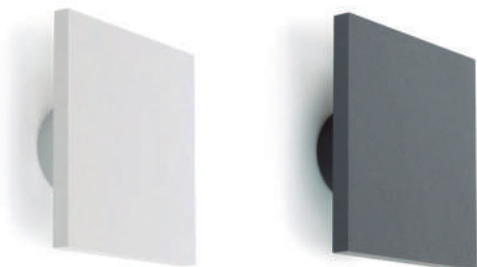

LED SMD 6.5W 800lm 3000K

□ 953A-L3108A-01

■ 953A-L3108A-04



Acabado blanco o antracita / White or anthracite finish

# CLOUD

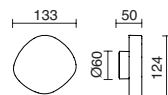

LED SMD AC 7.5W 800lm 3000K

□ 952A-L3107A-01

■ 952A-L3107A-04



Acabado blanco o antracita / White or anthracite finish







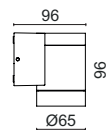

GU10 LED 4.5W max.

- 555F-G21X1A-01
- 555F-G21X1A-04

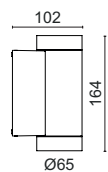

GU10 LED **2x** 4.5W max.

- 555G-G21X1A-01
- 555G-G21X1A-04



Acabado blanco o antracita / White or anthracite finish

Lamps p.791









GU10 LED 4.5W max.

- 555C-G21X1A-01
- 555C-G21X1A-02
- 555C-G21X1A-03
- 555C-G21X1A-04



GU10 LED 2x 4.5W max.

- 555D-G21X1A-01
- 555D-G21X1A-02
- 555D-G21X1A-03
- 555D-G21X1A-04



Acabado blanco, negro, gris o antracita / White, black, grey or anthracite finish

Lamps p.791



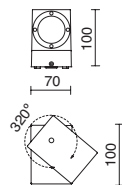

LED COB 7W 750lm 3000K

■ 452B-L0107A-04



Acabado antracita / Anthracite finish



# CAIRO

WALL LIGHTS



LED COB 7W 760lm 3000K

■ 537A-L0107A-04



Acabado antracita / Anthracite finish



# GUIU

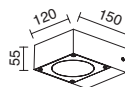

LED SMD 6W 642lm 3000K

■ 447B-L01D6A-04



Acabado antracita / Anthracite finish



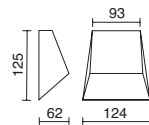
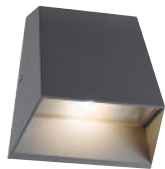

LED COB 7W 780lm 3000K

■ 445A-LO107A-04

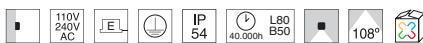

Acabado antracita / Anthracite finish

# CENADI

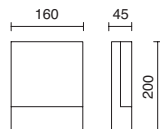

LED SMD 7W 800lm 3000K

■ 536A-LO106A-04



Acabado antracita / Anthracite finish

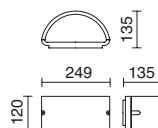

E27 Led/Fluo 20W max.

■ 051A-G05X1A-04

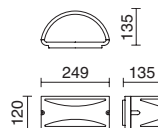

E27 Led/Fluo 20W max.

■ 051B-G05X1A-04

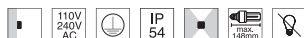

Acabado antracita / Anthracite finish

Lamps p.791

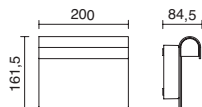

LED SMD 7W 850lm 3000K

□790A-L0106A-01

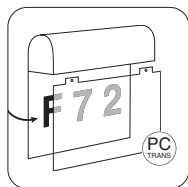

Incluye 1 juego de vinilos adhesivos del abecedario y 2 juegos de números del 0 al 9.

A set of alphabet and two sets of numbers from 0-9 vinyl stickers included.



Acabado blanco / White finish

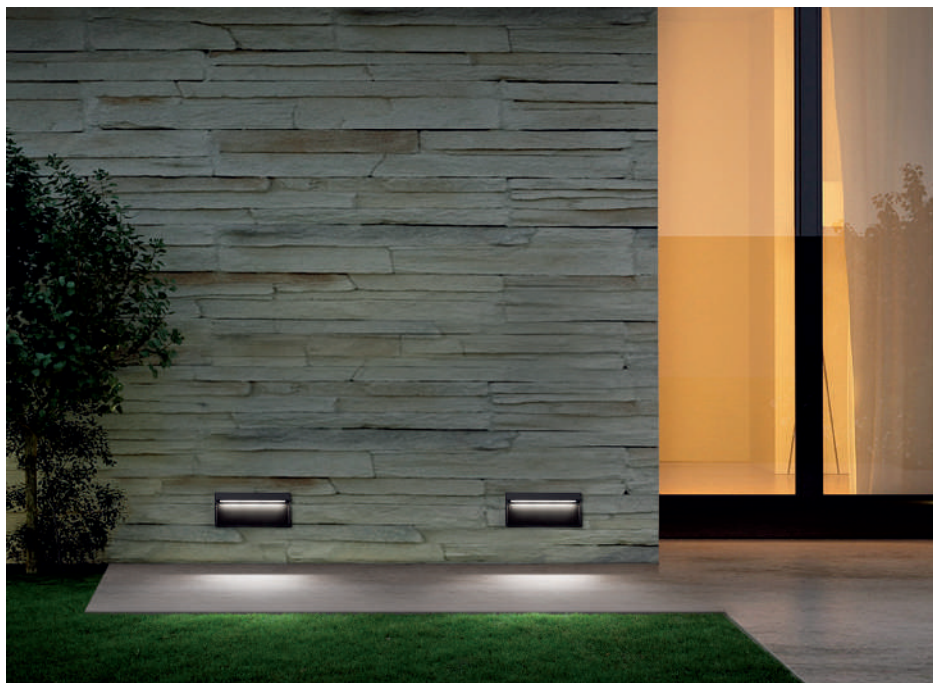

LED SMD 7W 780lm 3000k

- 847A-L0107B-01
- 847A-L0107B-02
- 847A-L0107B-04



Acabado blanco, negro o antracita / White, black or anthracite finish

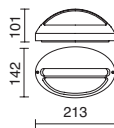

E27 Led/Fluo 8W max.

□ 162A-G05X1A-01



Acabado blanco / White finish

Lamps p.791

# PAMPERO



E27 Led/Fluo 11W max.

□ 232A-G05X1A-01

■ 232A-G05X1A-03



Acabado blanco o gris / White or grey finish

Lamps p.791



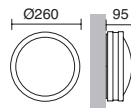

E27 Led/Fluo 23W max.

■ 321A-G05X1A-03

■ 321A-G05X1A-04

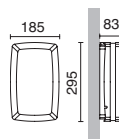

E27 Led/Fluo 2x 20W max.

■ 169A-G05X1A-03

■ 169A-G05X1A-04

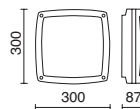

E27 Led/Fluo 2x 18W max.

■ 169C-G05X1A-04



Acabado gris o antracita / Grey or anthracite finish

Lamps p.791





LED SMD AC 20W 2200lm 3000K

- 1049A-L3120B-01
- 1049A-L3120B-02

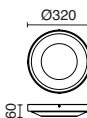

LED SMD AC 30W 3000lm 3000K

- 1049B-L3130B-01
- 1049B-L3130B-02



Acabado blanco o negro / White or black finish

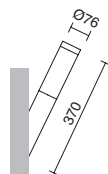

E27 Led/Fluo 11W max.

■ 003A-G05X1A-30

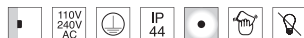

Acabado inox / Stainless steel finish

Lamps p.791



# GALERNA

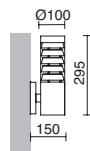

E27 Led/Fluo 18W max.

■ 117C-G05X1A-30

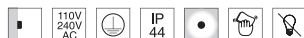

Acabado inox / Stainless steel finish

Lamps p.791



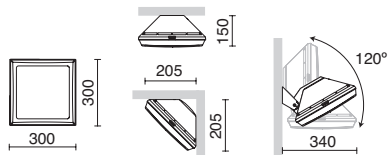

GX53 LED T2 4x 10W

■ 571A-G31X1A-02

K SELECT	3000K	1285lm
	4000K	1350lm
	6500K	1410lm



Acabado negro / Black finish

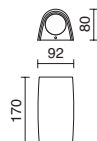

GU10 2x 3.5W

- 793A-G21X1A-01
- 793A-G21X1A-02
- 793A-G21X1A-03

K SELECT	2700K	329lm
	4000K	366lm



Acabado blanco, negro o gris / White, black or grey finish



947A-



947B-



947C-

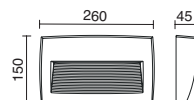
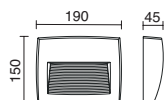
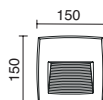

### L150

LED R7S Bulb 3,2W

- 947A-L3104A-01
- 947A-L3104A-02
- 947A-L3104A-03

### L190

LED R7S Bulb 7,5W

- 947B-L3109A-01
- 947B-L3109A-02
- 947B-L3109A-03

### L260

LED R7S Bulb 10,5W

- 947C-L3111A-01
- 947C-L3111A-02
- 947C-L3111A-03

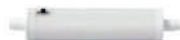

	3,2W	7,5W	10,5W
<b>K</b>	3000K	300lm	700lm
<b>SELECT</b>	4000K	360lm	810lm
	6500K	360lm	810lm
		1080lm	1080lm



Acabado blanco, negro o gris / White, black or grey finish

# CALM

WALL LIGHTS

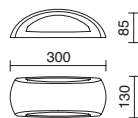

E27 LED 6W 800lm 2700K

- 646A-G05X1A-01
- 646A-G05X1A-02
- 646A-G05X1A-03

- 646B-G05X1A-01
- 646B-G05X1A-02
- 646B-G05X1A-03



Regulación de:

- Distancia:  $0 > 6$  m.
- Tiempo de activación: de 5 seg. a 8 min.
- Ángulo de detección:  $120^\circ$
- Daylight on:  $< 10$  lux

Adjustable:

- Distance:  $0 > 6$  m.
- Activation time: from 5 sec. to 8 min.
- Detection angle:  $120^\circ$
- Daylight on:  $< 10$  lux



Acabado blanco, negro o gris / White, black or grey finish

# HAIL

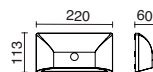

LED SMD AC 5W 480lm 3000K

- 954A-L3106B-01
- 954A-L3106B-04

Sensor de movimiento infrarrojo pasivo (PIR) no desactivable.  
Modo nocturno o 24h (día/noche)

Passive infrared motion sensor (PIR) not deactivatable.  
Night mode or 24h (day/night) mode.



Regulación de:

- Distancia:  $0 > 8$  m.
- Tiempo de activación: de 6 seg. a 8 min.
- Ángulo de detección:  $160^\circ$

Adjustable:

- Distance:  $0 > 8$  m.
- Activation time: from 6 sec. to 8 min.
- Detection angle:  $160^\circ$

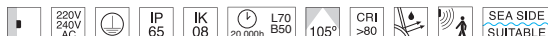

Acabado blanco o antracita / White or anthracite finish





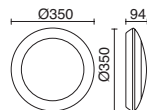

GX53 LED T2 11W 1300lm (2700K - 4000K - 6500K)

□ 579C-G31X1A-01



Regulación de:

- Distancia: 0>8 m.
- Tiempo de activación: de 6 seg. a 8 min.
- Ángulo de detección: 160°

Adjustable:

- Distance: 0>8 m.
- Activation time: from 6 sec. to 8 min.
- Detection angle: 160°

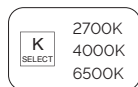

LED SMD 16W 1800lm 4000K + EMERGENCY LED 3W 250lm 4000K (3h max.)

□ 579C-L0216R-01

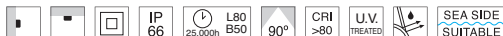

Acabado blanco / White finish



*Doble entrada lateral.  
Double side inlet.*

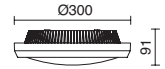

LED SMD 12.5W 1150lm 4000K

■ 522A-L0214B-03



Acabado gris / Grey finish

# MIR

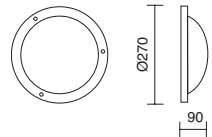

E27 Led/Fluo 23W max.

□ 203B-G05X1A-01

■ 203B-G05X1A-02

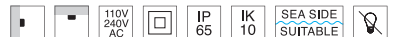

Acabado blanco o negro / White or black finish

Lamps p.791

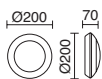

GX53 LED T2 3W

□ 559A-G31X1A-01

■ 559A-G31X1A-03



3000K	380lm
4000K	395lm
6500K	415lm

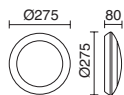

GX53 LED T2 11W

□ 559B-G31X1A-01

■ 559B-G31X1A-02

■ 559B-G31X1A-03



2700K	1325lm
4000K	1446lm
6500K	1470lm

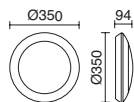

GX53 LED T2 11W

□ 559C-G31X1A-01

■ 559C-G31X1A-02



2700K	1325lm
4000K	1446lm
6500K	1470lm



Acabado blanco, negro o gris / White, black or grey finish

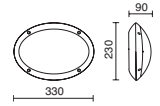

E27 Led/Fluo 23W max.

- 317A-G05X1A-01
- 317A-G05X1A-02
- 317A-G05X1A-03

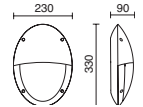

E27 Led/Fluo 23W max.

- 317B-G05X1A-01
- 317B-G05X1A-02
- 317B-G05X1A-03

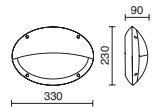

E27 Led/Fluo 23W max.

- 317C-G05X1A-01
- 317C-G05X1A-02
- 317C-G05X1A-03



Acabado blanco, negro o gris / White, black or grey finish

Lamps p.791

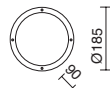

E27 Led/Fluo 12W max.

□ 107B-G05X1A-01

■ 107B-G05X1A-02

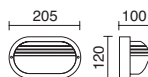

E27 Led/Fluo 12W max.

□ 107G-G05X1A-01

■ 107G-G05X1A-02

■ 107G-G05X1A-03

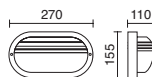

E27 Led/Fluo 21W max.

□ 107H-G05X1A-01

■ 107H-G05X1A-02



Acabado blanco, negro o gris / White, black or grey finish

Lamps p.791



107I-



107J-

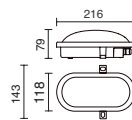
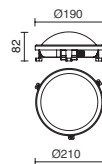

LED SMD 12W 840lm 4000K

□ 107I-L0212B-01

■ 107I-L0212B-02



□ 107J-L0212B-01

■ 107J-L0212B-02

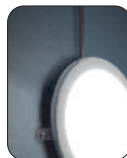

Con entrada lateral.  
With side inlet.



Acabado blanco o negro / White or black finish

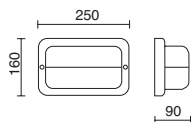

**3000K**  
LED SMD AC 9W 1160lm

**4000K**  
LED SMD AC 9W 1240lm

- 166A-L0109B-01
- 166A-L0109B-02

- 166A-L0209B-01
- 166A-L0209B-02

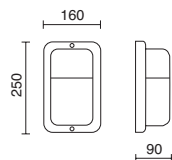

**3000K**  
LED SMD AC 9W 1160lm

**4000K**  
LED SMD AC 9W 1240lm

- 166B-L0109B-01
- 166B-L0109B-02

- 166B-L0209B-01
- 166B-L0209B-02



Acabado blanco o negro / White or black finish

Disponible versión con portalámparas E27  
E27 socket version available



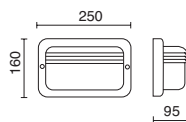

E27 Led/Hal/Fluo 42W max.

- 255A-G05X1A-01
- 255A-G05X1A-02

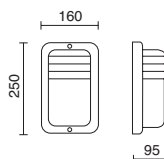

E27 Led/Hal/Fluo 42W max.

- 255B-G05X1A-01
- 255B-G05X1A-02

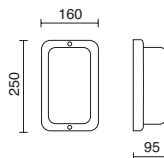

E27 Led/Hal/Fluo 42W max.

- 255C-G05X1A-01
- 255C-G05X1A-02



Acabado blanco o negro / White or black finish

Lamps p.791

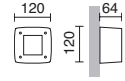

GX53 LED T2 3W

- 084K-G31X1A-02
- 084K-G31X1A-03

K SELECT	3000K	380lm
	4000K	395lm
	6500K	415lm

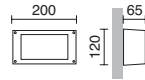

GX53 LED T2 3W

- 084Q-G31X1A-02
- 084Q-G31X1A-03

K SELECT	3000K	380lm
	4000K	395lm
	6500K	415lm

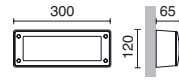

2x GX53 LED T2 3W

- 084U-G31X2A-01
- 084U-G31X2A-02
- 084U-G31X2A-03

K SELECT	3000K	760lm
	4000K	790lm
	6500K	830lm



Acabado blanco, negro o gris / White, black or grey finish

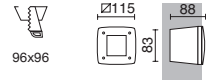

GX53 LED T2 3W

- 084A-G31X1A-01
- 084A-G31X1A-02
- 084A-G31X1A-03

K SELECT	3000K	380lm
	4000K	395lm
	6500K	415lm

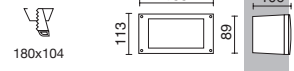

GX53 LED T2 3W

- 084G-G31X1A-01
- 084G-G31X1A-02
- 084G-G31X1A-03

K SELECT	3000K	380lm
	4000K	395lm
	6500K	415lm

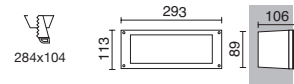

2x GX53 LED T2 3W

- 084A-G31X2A-01
- 084A-G31X2A-02
- 084A-G31X2A-03

K SELECT	3000K	760lm
	4000K	790lm
	6500K	830lm



Acabado blanco, negro o gris / White, black or grey finish



GX53 LED T2 3W

- 084C-G31X1A-01
- 084C-G31X1A-03

K SELECT	3000K	380lm
	4000K	395lm
	6500K	415lm

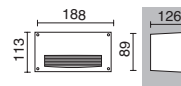

GX53 LED T2 3W

- 084I-G31X1A-01
- 084I-G31X1A-02
- 084I-G31X1A-03

K SELECT	3000K	380lm
	4000K	395lm
	6500K	415lm

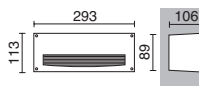

2x GX53 LED T2 3W

- 084C-G31X2A-01
- 084C-G31X2A-02
- 084C-G31X2A-03

K SELECT	3000K	760lm
	4000K	790lm
	6500K	830lm



Acabado blanco, negro o gris / White, black or grey finish

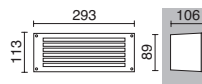

2x GX53 LED T2 3W

- 084B-G31X2A-02
- 084B-G31X2A-03

K SELECT	3000K	760lm
	4000K	790lm
	6500K	830lm

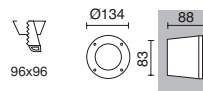

GX53 LED T2 3W

- 084D-G31X1A-02
- 084D-G31X1A-03

K SELECT	3000K	380lm
	4000K	395lm
	6500K	415lm

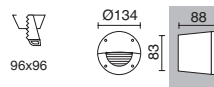

GX53 LED T2 3W

- 084F-G31X1A-02
- 084F-G31X1A-03



K SELECT	3000K	380lm
	4000K	395lm
	6500K	415lm



Acabado negro o gris / Black or grey finish



453A-



453B-

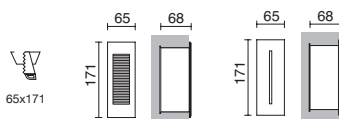

LED SMD 3W 170lm 3000K

- 543A-LO103A-03
- 543A-LO103A-04



- 543B-LO103A-03
- 543B-LO103A-04



Acabado gris o antracita / Grey or anthracite finish



854A-



854B-

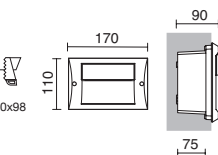
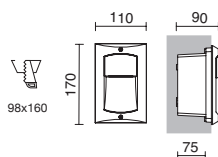

LED SMD 4W 480lm 3000K

□ 854A-L0104A-01

■ 854A-L0104A-04

□ 854B-L0104A-01

■ 854B-L0104A-04



Acabado blanco o antracita / White or anthracite finish

# AMBERES

WALL LIGHTS

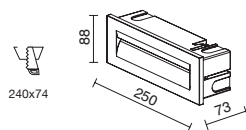
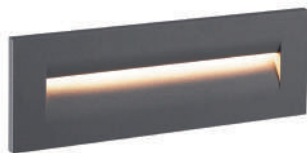

LED SMD 9W 760lm 3000K

■ 643A-LO109A-04

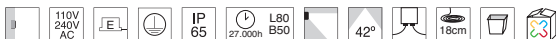

Acabado antracita / Anthracite finish

# DAS

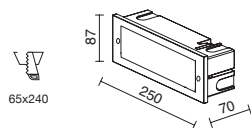

LED SMD 5W 710lm 3000K

■ 544A-LO105A-30



Acabado inox / Stainless steel finish



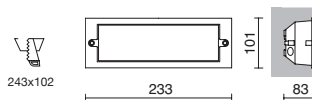

E27 Led/Fluo 20W max.

- 350A-G05X1A-01
- 350A-G05X1A-02

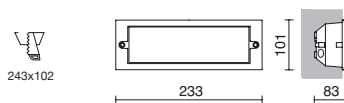

E27 Led/Fluo 20W max.

- 350C-G05X1A-30

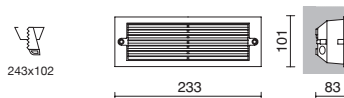
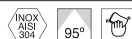

E27 Led/Fluo 20W max.

- 350D-G05X1A-30

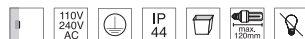
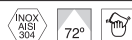

Acabado blanco, negro o inox / White, black or stainless steel finish

Lamps p.791



R7s LED Bulb 10,5W max. 1100lm

- 949A-L3111A-01
- 949A-L3111A-02
- 949A-L3111A-03

K SELECT	2700K	1000lm
	4000K	1080lm
	6500K	1080lm



Acabado blanco, negro o gris / White, black or grey finish

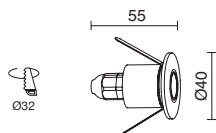

LED SMD 1W 105lm 3000K

■ 546A-L0101A-30

NO BOX INCLUDED  
Ø32mm PVC TUBE



*Posibilidad de añadir filtros de colores (no incluidos).  
Possibility to add colour filters (not included).*

- A14A-546-07
- A14A-546-05
- A14A-546-06



Acabado inox / Stainless steel finish

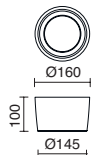

GX53 LED T2 10W

□ 948A-L3110A-01

■ 948A-L3110A-02

■ 948A-L3110A-03

K SELECT	3000K	1285lm
	4000K	1350lm
	6500K	1410lm



Acabado blanco, negro o gris / White, black or grey finish

# CUB

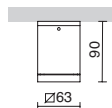

GU10 LED 4.5W max.

□ 555E-G21X1A-01

■ 555E-G21X1A-02

■ 555E-G21X1A-03

■ 555E-G21X1A-04



Acabado blanco, negro, gris o antracita / White, black, grey or anthracite finish

Lamps p.791







# Uplights

*¿Cómo instalar un empotrable en el suelo?*

---

*Video*



*How to install a recessed floor?*

---

*Video*





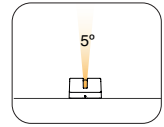
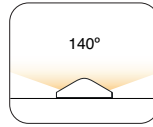
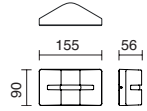
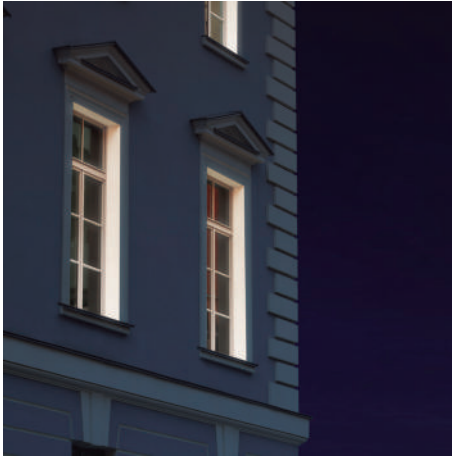

LED SMD 2,5W 170lm 3000K

■ 951A-L3103A-04

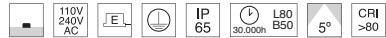

Acabado antracita / Anthracite finish

# BERNA

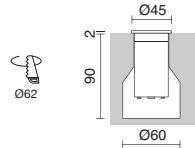

LED SMD 1W 105lm 3000K

■ 912A-L0101F-30



Alimentador / Power supply  
12W (max. 9 unit.)

□ B02Q-X3312F-01

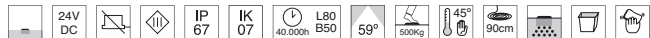
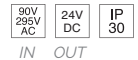

Acabado inox / Stainless steel finish



CONNECTORS p.793



Evite siempre colocar las luminarias en vaguadas o depresiones del terreno. Es indispensable realizar un drenaje.  
Always avoid placing the lights in valleys or depressions of the ground. It is essential to carry out an efficient drainage.



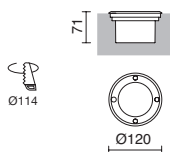

GX53 LED T2 3W 350lm 4000K

■ 379A-G31X1A-30

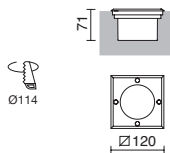

GX53 LED T2 3W 350lm 4000K

■ 379B-G31X1A-30



Acabado inox / Stainless steel finish



Evite siempre colocar las luminarias en vaguadas o depresiones del terreno. Es indispensable realizar un drenaje. Always avoid placing the lights in valleys or depressions of the ground. It is essential to carry out an efficient drainage.





O37A-



O37B-

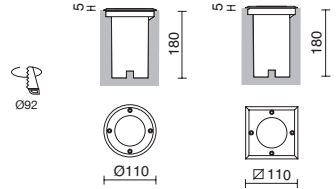

GU10 LED 4.5W max.

■ O37A-G21X1A-30

■ O37B-G21X1A-30



Doble posición del portalámparas.  
Double positioning of the lamp holder.



Orientable 30°  
Tilting 30°

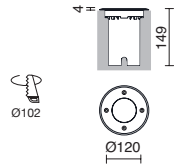

GU10 LED 3.5W max.

■ O37D-G21X1A-30

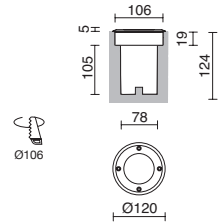
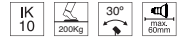

## BORA LED

LED SMD 3W 330lm 4000K

■ O37A-LO2D1A-30

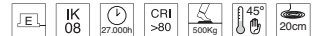

Acabado inox / Stainless steel finish



Lamps p.792



Evite siempre colocar las luminarias en vaguadas o depresiones del terreno. Es indispensable realizar un drenaje.  
Always avoid placing the lights in valleys or depressions of the ground. It is essential to carry out an efficient drainage.

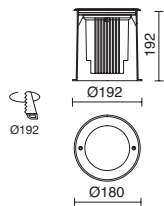

LED COB 15W 1600lm 3000K

■ 792B-L3115A-30



Acabado inox / Stainless steel finish

# WALKER

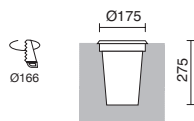

LED COB 6,5W 850lm 3000K

■ 349A-L0107B-30



Incorpora un cristal matizado interno.  
Incorporates internal frosted glass lens.

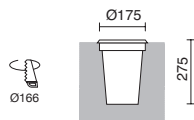

E27 Led/Fluo 23W max.

■ 349A-G05X1A-30



Acabado inox / Stainless steel finish

Lamps p.791



Evite siempre colocar las luminarias en vaguadas o depresiones del terreno. Es indispensable realizar un drenaje.  
Always avoid placing the lights in valleys or depressions of the ground. It is essential to carry out an efficient drainage.



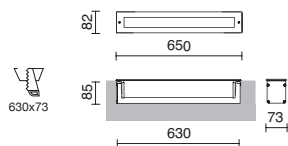

LED SMD 15W 1110lm 4000K

■ 257C-L0215B-30

ALU	INOX	GLASS (TRANS)		110V 240V AC	EL		IP 67	IK 07		L80 B50	30°	CRI >80		500kg		40cm		
-----	------	---------------	--	--------------	----	--	-------	-------	--	---------	-----	---------	--	-------	--	------	--	--

Acabado inox / Stainless steel finish

CONNECTORS p.793



*Evite siempre colocar las luminarias en valles o depresiones del terreno. Es indispensable realizar un drenaje. Always avoid placing the lights in valleys or depressions of the ground. It is essential to carry out an efficient drainage.*

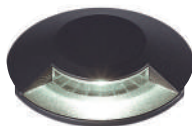

645A-



645B-

**3000K**  
LED SMD 7W 700lm

■ 645A-L0107A-04

■ 645B-L0107A-04

**4000K**  
LED SMD 7W 744lm

■ 645A-L0207A-04

■ 645B-L0207A-04



Ø118

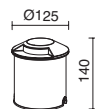

110°



99°

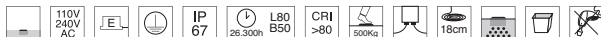

Acabado antracita / Anthracite finish



CONNECTORS p.793



Evite siempre colocar las luminarias en vaguadas o depresiones del terreno. Es indispensable realizar un drenaje.  
Always avoid placing the lights in valleys or depressions of the ground. It is essential to carry out an efficient drainage.

# BELGRADO

UPLIGHTS

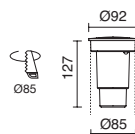

GU10 LED 3,5W

■ 557A-G21X1A-02

■ 557B-G21X1A-02

■ 557C-G21X1A-02

K SELECT	2700K	329lm
	4000K	366lm

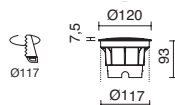

GX53 LED T2 3W

■ 373A-G31X1A-02

■ 373B-G31X1A-02

■ 373C-G31X1A-02

K SELECT	3000K	380lm
	4000K	395lm
	6500K	415lm



GX53 LED T2 10W

■ 372A-G31X1A-02

■ 372B-G31X1A-02

■ 372C-G31X1A-02

K SELECT	3000K	1285lm
	4000K	1350lm
	6500K	1410lm

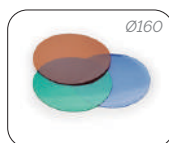

Possibilidad de añadir filtros de colores (no incluidos).  
Possibility to add colour filters (not included).

● A14A-409-08

● A14A-409-05

● A14A-409-06



Acabado negro / Black finish



Evite siempre colocar las luminarias en vaguadas o depresiones del terreno. Es indispensable realizar un drenaje.  
Always avoid placing the lights in valleys or depressions of the ground. It is essential to carry out an efficient drainage.



G9 LED Bulb 1,7W max. 170lm 3000K

- 950B-L3102A-01
- 950B-L3102A-02
- 950B-L3102A-03



G9 LED Bulb 1,7W max. 170lm 3000K

- 950C-L3102A-01
- 950C-L3102A-02
- 950C-L3102A-03



Acabado blanco, negro o gris / White, black or grey finish



Evite siempre colocar las luminarias en vaguadas o depresiones del terreno. Es indispensable realizar un drenaje.  
Always avoid placing the lights in valleys or depressions of the ground. It is essential to carry out an efficient drainage.



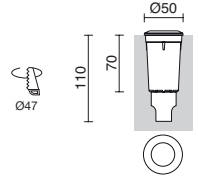

G9 LED Bulb 1.7W max. 170lm 3000K

- |  |  |
|--|--|
| <input type="checkbox"/> ● 950A-L1002A-01            | <input type="checkbox"/> ○ 950A-L3102A-01            |
| <input checked="" type="checkbox"/> ● 950A-L1002A-02 | <input checked="" type="checkbox"/> ○ 950A-L3102A-02 |
| <input checked="" type="checkbox"/> ● 950A-L1002A-03 | <input checked="" type="checkbox"/> ○ 950A-L3102A-03 |

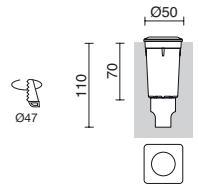
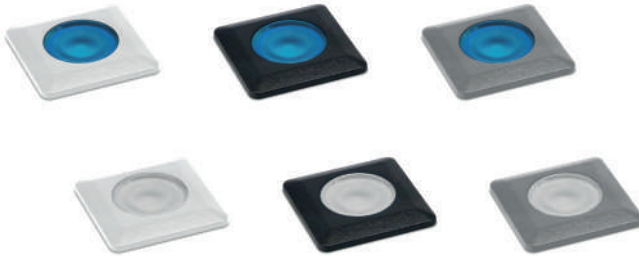

G9 LED Bulb 1.7W max. 170lm 3000K

- |  |  |
|--|--|
| <input type="checkbox"/> ● 950D-L1002A-01            | <input type="checkbox"/> ○ 950D-L3102A-01            |
| <input checked="" type="checkbox"/> ● 950D-L1002A-02 | <input checked="" type="checkbox"/> ○ 950D-L3102A-02 |
| <input checked="" type="checkbox"/> ● 950D-L1002A-03 | <input checked="" type="checkbox"/> ○ 950D-L3102A-03 |



Acabado blanco, negro o gris / White, black or grey finish



Evite siempre colocar las luminarias en vaguadas o depresiones del terreno. Es indispensable realizar un drenaje.  
Always avoid placing the lights in valleys or depressions of the ground. It is essential to carry out an efficient drainage.



# Spotlights



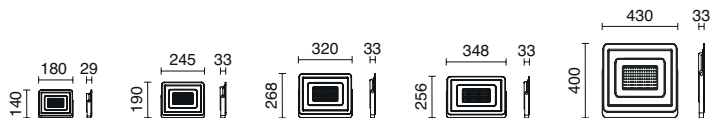

3000K	4000K	6500K
LED SMD AC 30W 3335lm	LED SMD 30W 3425lm	LED SMD 30W 3425lm
■ 1047A-L3130B-02	■ 1047A-L3330B-02	■ 1047A-L3730B-02
LED SMD AC 50W 5190lm	LED SMD 50W 5535lm	LED SMD 50W 5535lm
■ 1047B-L3150B-02	■ 1047B-L3350B-02	■ 1047B-L3750B-02
LED SMD AC 100W 10478lm	LED SMD 100W 11113lm	LED SMD 100W 11113lm
■ 1047C-L31A1B-02	■ 1047C-L33A1B-02	■ 1047C-L37A1B-02
LED SMD AC 150W 15640lm	LED SMD 150W 16175lm	LED SMD 150W 16175lm
■ 1047D-L31A4B-02	■ 1047D-L33A4B-02	■ 1047D-L37A4B-02
LED SMD AC 200W 19555lm	LED SMD 200W 20805lm	LED SMD 200W 20805lm
■ 1047E-L31A5B-02	■ 1047E-L33A5B-02	■ 1047E-L37A5B-02



Acabado negro / Black finish

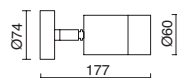

GU10 LED 4.5W max.

■ 538A-G21X1A-04



Acabado antracita / Anthracite finish

# NAGORE



851A-



851B-

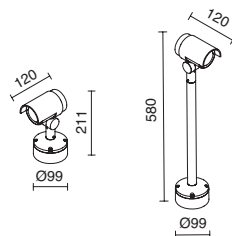

LED COB AC 10W 1100lm 3000K

■ 851A-L3110B-04

■ 851B-L3110B-04



Acabado antracita / Anthracite finish





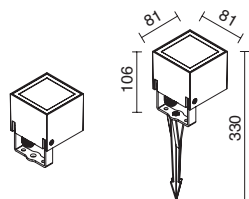

LED SMD 8W 430lm 3000K

■ 551B-L0108A-04



Acabado antracita / Anthracite finish

 CONNECTORS p.793



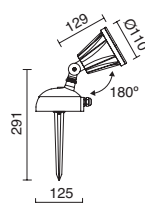
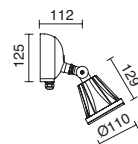

GU10 HAL 50W max / GU10 LED 3.5W max.

- 279A-G21X1A-02
- 279A-G21X1A-03

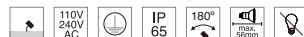

Acabado negro o gris / Black or grey finish

Lamps p.792

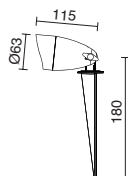

**3000K**

LED SMD AC 6W max. 640lm

■ 996A-L3106B-04

■ 996A-L3106C-04

**4000K**

LED SMD AC 6W max. 660lm

■ 996A-L3306B-04

220V  
240V  
AC

110V  
130V



Acabado antracita / Anthracite finish

CONNECTORS p.793

# GERONIMO

SPOTLIGHTS

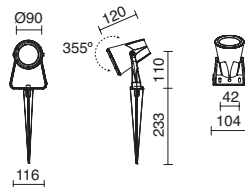

GU10 LED 4,5W max.

■ 463A-G21X1A-02



Acabado negro / Black finish

Lamps p.792

CONNECTORS p.793

# LULU

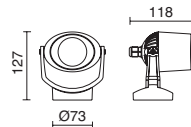

GU10 LED 3,5W

■ 572A-G21X1A-02

K SELECT	2700K	329lm
	4000K	366lm

**Piqueta / Spike**

RESIN

73

■ A05A-409-02



Acabado negro / Black finish

Lamps p.792

CONNECTORS p.793

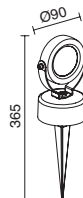

LED COB 7W 777lm 3000K

■ 482A-LO107A-04



Acabado antracita / Anthracite finish

# ARAMO

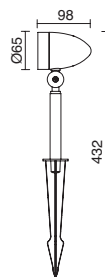

GU10 LED 4,5W max.

■ 539A-G21X1A-04



Acabado antracita / Anthracite finish

Lamps p.792

 CONNECTORS p.793





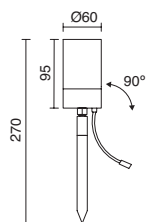

GU10 LED 4,5W max.

■ 172A-G21X1A-30

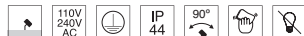

Acabado inox / Stainless steel finish

Lamps p.792



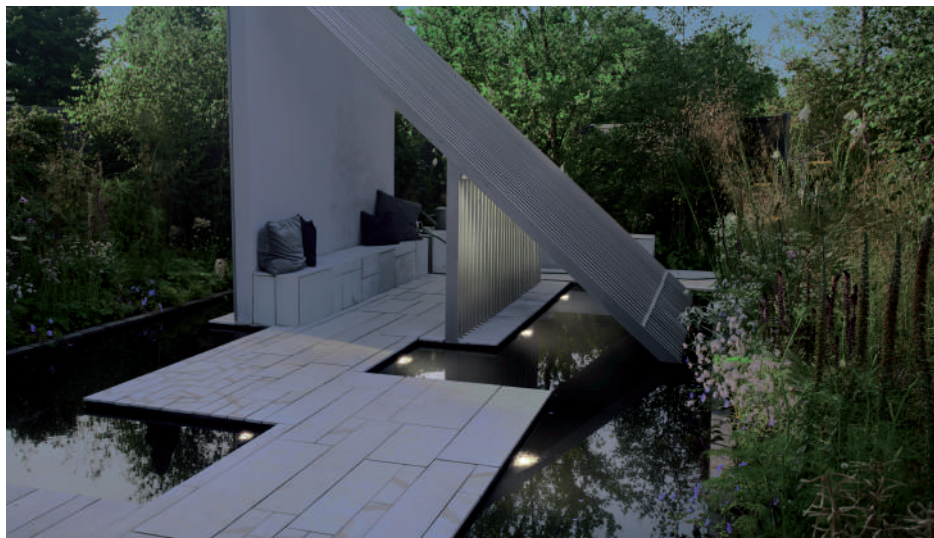

LED SMD 3W 250lm 4000K





■ 642A-LO203D-30

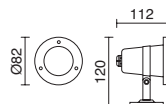

GU5,3 LED HAL 3,5W max.

■ 642A-G23X1D-30



	<b>Alimentador / Power supply</b>			
	IN 220-240 V AC / OUT 12 V AC max. 50W			
BO2J-X3350D-02				
		IN	OUT	



Acabado inox / Stainless steel finish



Lamps p.790



CONNECTORS p.793





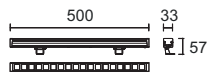
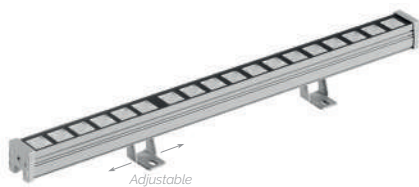

**3000K**

LED SMD 18Wmax. 2430lm

■ 1025A-L3118F40-03

■ 1025A-L3118FKO-03

**4000K**

LED SMD 18Wmax. 2610lm

■ 1025A-L3318F40-03

■ 1025A-L3318FKO-03

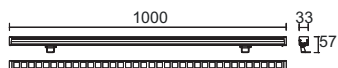

**3000K**

LED SMD 36W 4860lm

■ 1025B-L3136F40-03

■ 1025B-L3136FKO-03

**4000K**

LED SMD 36W 5220lm

■ 1025B-L3336F40-03

■ 1025B-L3336FKO-03



Acabado gris / Grey finish

 CONNECTORS p.793

Regulable con dispositivos de control específicos y Led Driver 24V DC remotos (p.795)  
Adjustable with specific control devices and remote Led Driver 24V DC (p.795)



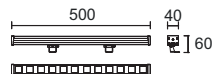
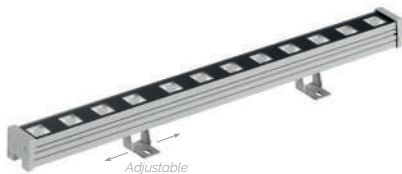

LED SMD RGBW (4000K) 18W max. 1200lm

■ 1025C-L1418F4X-03



■ 1025C-L1418FKX-03

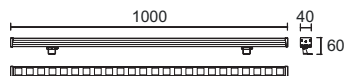
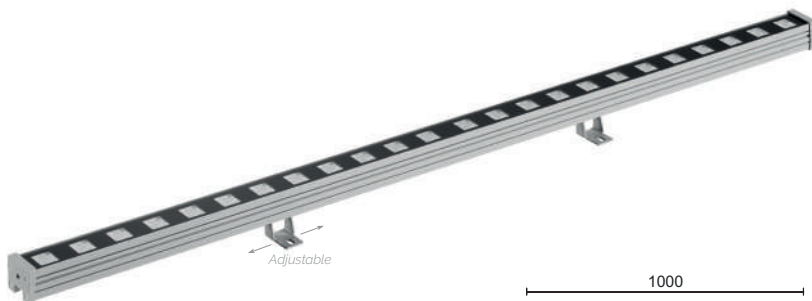

LED SMD RGBW (4000K) 36W max. 2400lm

■ 1025D-L1436F4X-03



■ 1025D-L1436FKX-03



Acabado gris / Grey finish

Led Driver 24V DC remotos a consultar (p. 795)  
Remote Led Driver 24V DC under request (p. 795)

CONNECTORS p.793



Kit Controlador y mando a distancia para RGB/RGBW  
Controller and remote control kit for RGB/RGBW

CONT.R9+XC

**Controller**

Control: RF 2.4Ghz  
Exit sign: DMX512  
Input Voltage: 5-24Vdc  
10 static colors  
32 dynamics modes

**Remote Control**

Control: 1 zone (30m)  
power supply: 1xCR2032  
non inclue (3Vdc)  
Exit sign: RF 2.4Ghz



# Bollards

*¿Cómo instalar una baliza?*

---

*Video*



*How to install a bollard?*

---

*Video*





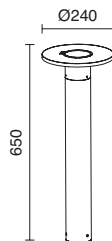

LED SMD 8W 1300lm 3000K

■ 1054B-L3110B-04



Acabado antracita / Anthracite finish

 Conector incluido / connector included



 Instalar sobre suelo rígido. En césped o tierra, añadir pilastera de cemento.  
Install on rigid ground. On grass or earth, add pilaster cement.

p.444









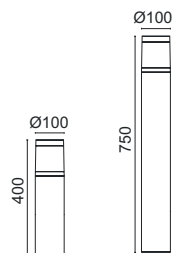

**h400**  
LED SMD 7W

■ 1072B-L4108BBF-02

**h750**  
LED SMD 7W

■ 1072C-L4108BBF-02

 Conector incluido  
connector included

K <small>SELECT</small>	3000K	7901lm
	4000K	8451lm



Acabado negro / Black finish

 Instalar sobre suelo rígido. En césped o tierra, añadir pilastra de cemento.  
Install on rigid ground. On grass or earth, add pilaster cement.





Imitación madera  
Imitation wood

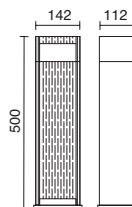

LED SMD 7W 810lm 3000K

■ 1027B-L3107B30-04



Acabado antracita / Anthracite finish



Instalar sobre suelo rígido. En césped o tierra, añadir pilastra de cemento.  
Install on rigid ground. On grass or earth, add pilaster cement.

p.450



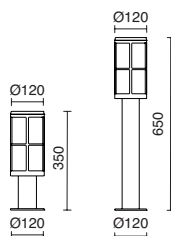

**h350**  
E27 Led/Fluo 18W max.

- 1015B-G05X1A-01
- 1015B-G05X1A-04

**h650**  
E27 Led/Fluo 18W max.

- 1015C-G05X1A-01
- 1015C-G05X1A-04



Acabado blanco o antracita / White or anthracite finish

Lamps p.791



Instalar sobre suelo rígido. En césped o tierra, añadir pilastra de cemento.  
Install on rigid ground. On grass or earth, add pilaster cement.

p.451





# BUCKET

BOLLARDS



976B-



976C-

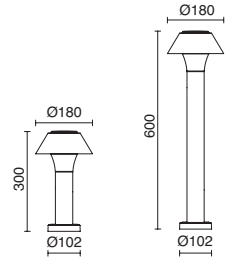

## 3000K

LED SMD 10,5W 1680lm

- 976B-L3110B-04
- 976C-L3110B-04

- 976B-L31RCB-04
- 976C-L31RCB-04

## 4000K

LED SMD 10,5W 1770lm

- 976B-L3310B-04
- 976C-L3310B-04

- 976B-L33RCB-04
- 976C-L33RCB-04



Acabado antracita / Anthracite finish



Instalar sobre suelo rígido. En césped o tierra, añadir pilastra de cemento.  
Install on rigid ground. On grass or earth, add pilaster cement.

p.453









982B-



982C-

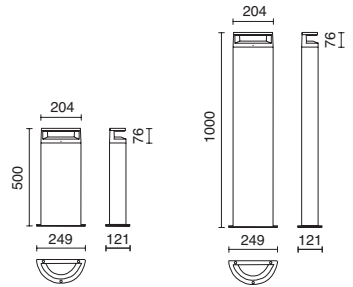

**3000K**  
LED SMD 9.5W 1295lm

- 982B-L3109A-02
- 982C-L3109A-02

**4000K**  
LED SMD 9.5W 1405lm

- 982B-L3309A-02
- 982C-L3309A-02



Acabado negro / Black finish

 Instalar sobre suelo rígido. En césped o tierra, añadir pilastra de cemento.  
Install on rigid ground. On grass or earth, add pilaster cement.

p.541



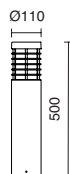

E27 Led/Fluo 15W max.

■ 1016B-G05X1A-04



Acabado antracita / Anthracite finish

Lamps p.791



Instalar sobre suelo rígido. En césped o tierra, añadir pilastra de cemento.  
Install on rigid ground. On grass or earth, add pilaster cement.

p.454





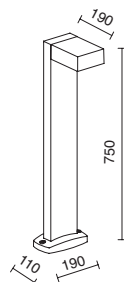

GX53 LED T2 3W 350lm 4000K

■ 447A-G31X1A-04



Acabado antracita / Anthracite finish

Lamps p.791



Instalar sobre suelo rígido. En césped o tierra, añadir pilastra de cemento.  
Install on rigid ground. On grass or earth, add pilaster cement.

p.467



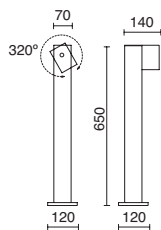

LED COB 7W 750lm 3000K

■ 452A-LO107A-04



Acabado antracita / Anthracite finish



Instalar sobre suelo rígido. En césped o tierra, añadir pilastra de cemento.  
Install on rigid ground. On grass or earth, add pilaster cement.

p.466





LED COB 7W 760lm 3000K

■ 537B-L0107A-04



Acabado antracita / Anthracite finish



Instalar sobre suelo rígido. En césped o tierra, añadir pilaster de cemento.  
Install on rigid ground. On grass or earth, add pilaster cement.



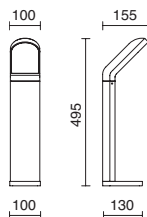

LED SMD 10W 1200lm 3000K

■ 534B-LO109A-04

110V  
240V  
AC

■ 534D-LO109B-04

220V  
240V  
AC



*Regulación de:*  
 - Distancia: 0>8 m.  
 - Tiempo de activación: de 5 seg. a 8 min.  
 - Intensidad de la luz: 10 - 2000lux  
 - Ángulo de detección: 100°

*Adjustable:*  
 - Distance: 0>8 m.  
 - Activation time: from 5 sec. to 8 min.  
 - Light intensity: 10 - 2000lux  
 - Detection angle: 100°



Acabado antracita / Anthracite finish



Instalar sobre suelo rígido. En césped o tierra, añadir pilastra de cemento.  
 Install on rigid ground. On grass or earth, add pilaster cement.

p.456





848C-



848B-



**h900**  
LED SMD 19W 2500lm 3000K

■ 848B-LO118A-04

**h2200**  
LED SMD 19W 2500lm 3000K

■ 848C-LO118A-04



Acabado antracita / Anthracite finish



Instalar sobre suelo rígido. En césped o tierra, añadir pilastra de cemento.  
Install on rigid ground. On grass or earth, add plaster cement.

p.455



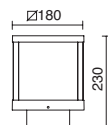

LED COB 12W 1300lm 3000K

■ 791B-L0112A-04



Acabado antracita / Anthracite finish



Instalar sobre suelo rígido. En césped o tierra, añadir pilastra de cemento.  
Install on rigid ground. On grass or earth, add pilaster cement.

p.457





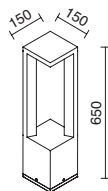

LED COB 8W 800lm 3000K

■ 552A-L0108A-04



Acabado antracita / Anthracite finish



Instalar sobre suelo rígido. En césped o tierra, añadir pilastra de cemento.  
Install on rigid ground. On grass or earth, add pilaster cement.

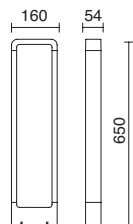

LED COB 7W 750lm 3000K

■ 455A-LO105A-04



Acabado antracita / Anthracite finish

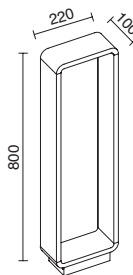

LED COB AC 10W 1100lm 3000K

□ 455B-LO110B-01

■ 455B-LO110B-04

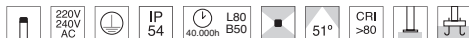

Acabado blanco o antracita / White or anthracite finish



Instalar sobre suelo rígido. En césped o tierra, añadir pilastra de cemento.  
Install on rigid ground. On grass or earth, add pilaster cement.



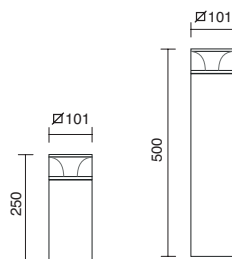

**h250**

LED SMD 7W 850lm 3000K

■ 941A-L0106A -04

**h500**

LED SMD 7W 850lm 3000K

■ 941B-L0106A-04



Acabado antracita / Anthracite finish



Instalar sobre suelo rígido. En césped o tierra, añadir pilastra de cemento.  
Install on rigid ground. On grass or earth, add pilaster cement.

2 Schuko (type C/F) - 16A/ 250V max 3680W

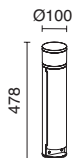

G9 2.5W 160lm 3000K

■ 995A-H20X1A-04



Acabado antracita / Anthracite finish

# JASMIN

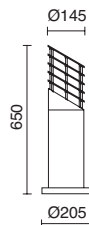

E27 Led/Fluo 23W max.

■ 159A-G05X1A-03

■ 159A-G05X1A-04



Acabado gris o antracita / Grey or anthracite finish

Lamps p.791

 Instalar sobre suelo rígido. En césped o tierra, añadir pilastra de cemento.  
Install on rigid ground. On grass or earth, add pilaster cement.





### h300

E27 Led/Fluo 23W max.

- 228A-G05X1A-01
- 228A-G05X1A-02
- 228A-G05X1A-04
- 228A-G05X1A-05
- 228A-G05X1A-91

### h400

E27 Led/Fluo 23W max.

- 228B-G05X1A-01
- 228B-G05X1A-02
- 228B-G05X1A-04
- 228B-G05X1A-05
- 228B-G05X1A-91

### h600

E27 Led/Fluo 23W max.

- 228C-G05X1A-01
- 228C-G05X1A-02
- 228C-G05X1A-04
- 228C-G05X1A-05
- 228C-G05X1A-91

### h800

E27 Led/Fluo 23W max.

- 228D-G05X1A-01
- 228D-G05X1A-02
- 228D-G05X1A-04
- 228D-G05X1A-05
- 228D-G05X1A-91

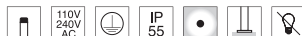

Acabado blanco, negro, antracita, verde o marrón cobrizo / White, black, anthracite, green or copper brown

Lamps p.791



Instalar sobre suelo rígido. En césped o tierra, añadir pilastro de cemento.  
Install on rigid ground. On grass or earth, add pilaster cement.

# NATAN

BOLLARDS

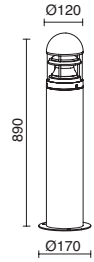

E27 Fluo 20W max. (Ø48mm)

■ 448A-G05X1A-04



Acabado antracita / Anthracite finish

Lamps p.791

# SIROCO

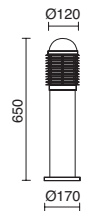

E27 Led/Fluo 14W max.

■ 286A-G05X1A-03

■ 286A-G05X1A-04



Acabado gris o antracita / Grey or anthracite finish

Lamps p.791



Instalar sobre suelo rígido. En césped o tierra, añadir pilastra de cemento.  
Install on rigid ground. On grass or earth, add pilaster cement.

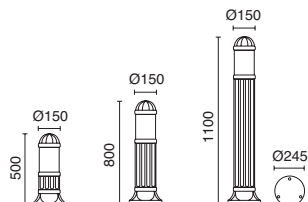

**h500**

GX53 LED T2 10W

■ 272A-G31X1A-02

**h800**

GX53 LED T2 10W

■ 272B-G31X1A-02

**h1100**

GX53 LED T2 10W

■ 272C-G31X1A-02



K SELECT	3000K	1285lm
	4000K	1350lm
	6500K	1410lm

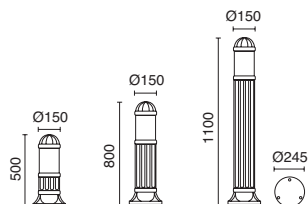

**h500**

E27 Led/Fluo 30W max.

■ 272A-G05X1A-02

**h800**

E27 Led/Fluo 30W max.

■ 272B-G05X1A-02

**h1100**

E27 Led/Fluo 30W max.

■ 272C-G05X1A-02



Acabado negro / Black finish

Lamps p.791



Instalar sobre suelo rígido. En césped o tierra, añadir pilastra de cemento.  
Install on rigid ground. On grass or earth, add pilaster cement.

# ABREGO

BOLLARDS



E27 Led/Fluo 11W max.

003B-G05X1A-30



Acabado inox / Stainless steel finish

Lamps p.791



# GALERNA

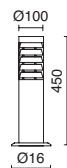

E27 Led/Fluo 18W max.

117B-G05X1A-30



Acabado inox / Stainless steel finish

Lamps p.791



Instalar sobre suelo rígido. En césped o tierra, añadir pilastro de cemento.  
Install on rigid ground. On grass or earth, add pilaster cement.





Solar





1044A-



1044B-



1044C-

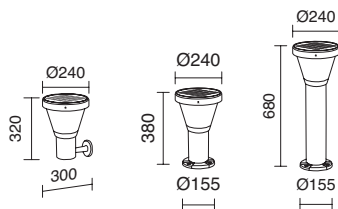

LED SMD 4.5W 435lm/445lm 3000K/4000K

■ 1044A-L4105K-02



■ 1044B-L4105K-02

■ 1044C-L4105K-02



  	1st H.	100%
	2nd H.	80%
	3rd-4th H.	60%
	5th-7th H.	40%
	8th-12th H.	30%

< 25 lux

Tiempo de carga: 6/8h  
Duración carga completa: Hasta 12h

Loading time: 6/8h  
Full load duration: Up to 12h

K  
SELECT

MODE A	3000K	1285lm
MODE B	4000K	1350lm
MODE C	OFF	-



100% Seguro / Safety  
>2000 Ciclos / Cycles  
Carga rápida / Fast charge



Acabado negro / Black finish



Instalar sobre suelo rígido. En césped o tierra, añadir pilastra de cemento.  
Install on rigid ground. On grass or earth, add pilaster cement.

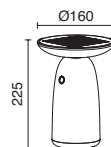

LED SMD 10W 1000lm 3000K

■ 1041A-L4103K-02

< 25 lux	MODE A	100lm	10h
	MODE B	500lm	5h
	MODE C	1000lm	1,5h
	MODE D	OFF	-



Tiempo de carga: 8h (solar) / 4h (USB)  
Loading time: 8h (sunshine) / 4h (USB)

ABS + ALU



Micro  
USB



Acabado negro / Black finish

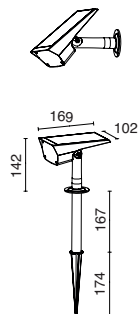

LED SMD 2W 160lm 3000K

■ 1043A-L4103K-02



< 25 Lux	MODE A	100%	12h
	MODE B	60%	20h
	MODE C	OFF	-



Tiempo de carga: 5/6h  
Loading time: 5/6h



Acabado negro / Black finish





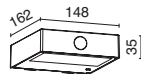

LED SMD 6W 600lm 3000K

■ 1042A-L4106K-02

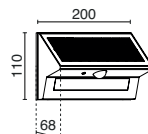

LED SMD 6W 600lm 3000K

■ 1042B-L4106K-02

< 25 Lux	MODE A	75lm	75lm	16h
	MODE B	75lm	400lm x25seg.	10h
	MODE C	OFF	600lm x25seg.	3h (ONx430)

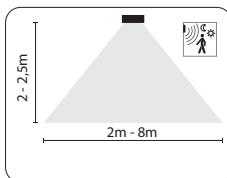

Tiempo de carga: 8h  
Loading time: 8h



Acabado negro / Black finish

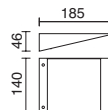

LED SMD 2,2W 480lm 3000K

■ 916B-L0103K-04

< 20 lux	ON	100%	✓	2,5 h
		15%	✗	20 h
-	OFF	0%	-	-

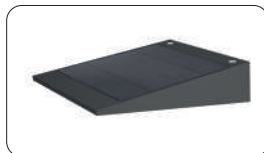

Tiempo de carga: 6/8h  
Loading time: 6/8h



Acabado antracita / Anthracite finish



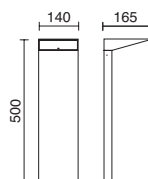

LED SMD 2,2W 480lm 3000K

■ 916A-LO103K-04

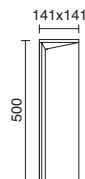

LED SMD 2,2W 525lm 3000K

■ 916C-LO103K-04



< 20 lux	ON	100%	✓	2,5 h
-	OFF	15%	X	20 h
-	-	0%	-	-

Tiempo de carga: 6/8h  
Loading time: 6/8h



Acabado antracita / Anthracite finish



Instalar sobre suelo rígido. En césped o tierra, añadir pilastera de cemento.  
Install on rigid ground. On grass or earth, add pilaster cement.



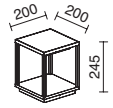

LED SMD 3,5W 300lm 3000K

■ 853B-L01X1K-04

*Posibilidad de fijar a suelo*  
*Possibility to fix to the ground*

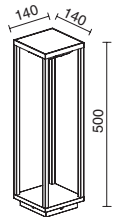

LED SMD 2,2W 231lm 3000K

■ 853A-L01X1K-04

*Posibilidad de fijar a suelo*  
*Possibility to fix to the ground*



*Incluye piqueta*  
*Spike Included*

TECNO  
POLIM

*Tiempo de carga: 8h*  
*Duración carga completa: Hasta 8h*

*Loading time: 8h*  
*Full load duration: Up to 8h*



Acabado antracita / Anthracite finish



*Instalar sobre suelo rígido. En césped o tierra, añadir pilastra de cemento.*  
*Install on rigid ground. On grass or earth, add pilaster cement.*



Decorative



# LITTA

DECORATIVE

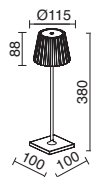

LED SMD 2.2W 200lm 3000K

- 914A-L0103L-01
- 914A-L0103L-02
- 914A-L0103L-90

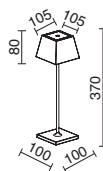

LED SMD 2.2W 200lm 3000K

- 914B-L0103L-01
- 914B-L0103L-02



Cargador USB incluido  
USB charger included  
5V DC/1A (110/240V 50/60Hz)

No utilizar mientras se está cargando.  
Do not use while charging.

Video



Acabado blanco, negro o marrón óxido / White, black or oxide brown finish



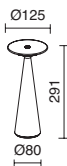

LED SMD 2.2W 189lm 3000K

□ 934A-L3102L-01

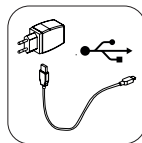

Cargador USB incluido  
USB charger included  
5V DC/1A (110/240V 50/60Hz)

No utilizar mientras se está cargando.  
Do not use while charging.



Acabado blanco / White finish



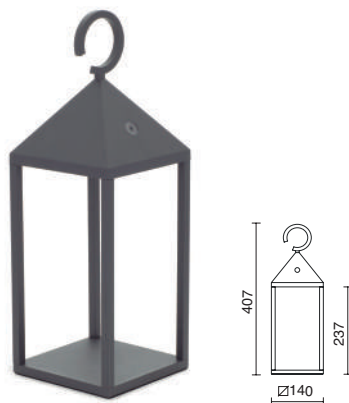

LED SMD 2.2W 187lm 3000K

■ 918A-L0103L-04



Cargador USB incluido  
USB charger included  
5V DC/1A (110/240V 50/60Hz)

No utilizar mientras se está cargando.  
Do not use while charging.



Acabado antracita / Anthracite finish

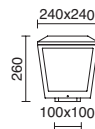

LED SMD 20W 2500lm 3000K

■ 911A-L0118A-04

*Posibilidad de fijar a suelo  
Possibility to fix to the ground*



Acabado antracita / Anthracite finish



*Instalar sobre suelo rígido. En césped o tierra, añadir pilastra de cemento.  
Install on rigid ground. On grass or earth, add pilaster cement.*

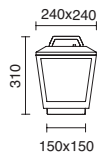

LED SMD 10W 1250lm 3000K

□ 911B-L0108L-01



2 intensidades de luz con pulsación directa  
2 light output intensities with direct pulse  
100%: 1050lm (4h)  
30%: 315lm (12h)



Cargador jack 3.5 mm incluido  
3.5 mm jack charger included  
17.5V DC / 0.65A (110-240V 50/60 Hz)

No utilizar mientras se está cargando.  
Do not use while charging.



Acabado blanco / White finish

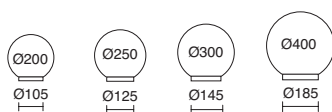

**Ø200**

E27 Led/Fluo 15W max.

■ 129E-G05X1A-02

**Ø250**

E27 Led/Fluo 23W max.

■ 129F-G05X1A-02

**Ø300**

E27 Led/Fluo 30W max.

■ 129G-G05X1A-02

**Ø400**

E27 Led/Fluo 30W max.

■ 129H-G05X1A-02



Opciones de instalación  
Installation Options



Acabado negro / Black finish

Lamps p.791





x12

Ampliable por tramos de 12 lámparas/tramo; máximo 720W totales.

Scalable by sections of 12 lamps/section; maximum 720w total.

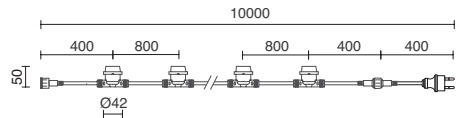

E27 LED 12 lampholder lamp Ø45

■ 858A-G05X1B-02



Kit 12 Lámparas / 12 lamps kit



12x E27 LED 4W 450lm 2000-2500K

858A-K12-632H-01



12x E27 LED 3W 330lm 3000K

858A-K12-632J-01



Complet transparent kit

858AK-632H-01



Complet opal kit

858AK-632J-01



110V  
240V  
AC



IP  
65



Acabado negro / Black finish



# Classic residential



573A-



573B-



## L195

E27 Led/Hal/Fluo 42W max.

■ 573A-G05X1A-34

## LØ215

E27 Led/Hal/Fluo 42W max.

■ 573B-G05X1A-34



Acabado latón / Brass finish

Lamps p.791



# MEDI

CLASSIC RESIDENTIAL

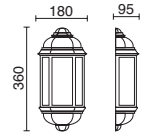

GLASS  
FRANS

E27 Led/Hal/Fluo 42W max.

□ 194B-G05X1A-01

■ 194B-G05X1A-02

GLASS  
MAT

E27 Led/Hal/Fluo 42W max.

□ 194A-G05X1A-01

■ 194A-G05X1A-02

ALU



Acabado blanco o negro / White or black finish

Lamps p.791

# KEO



167B-



167A-



167H-



167A-

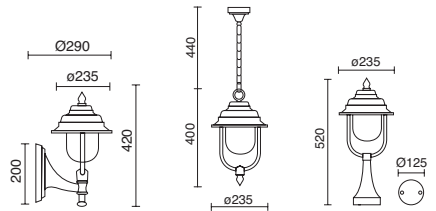

E27 Led/Hal/Fluo 42W max.

■ 167B-G05X1A-02

■ 167A-G05X1A-02

■ 167H-G05X1A-02

ALU

PMMA  
MAT



Acabado negro / Black finish

Lamps p.791



Instalar sobre suelo rígido. En césped o tierra, añadir pilastra de cemento.  
Install on rigid ground. On grass or earth, add pilaster cement.

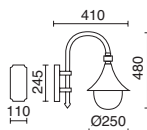

E27 Led/Hal/Fluo 42W max.

□ 332B-G05X1A-01

■ 332B-G05X1A-02

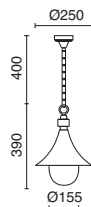

E27 Led/Hal/Fluo 42W max.

□ 332G-G05X1A-01

■ 332G-G05X1A-02



Acabado blanco o negro / White or black finish

Lamps p.791



Base y anclaje no incluido  
Base and anchor not included



E27 Led/Hal/Fluo 42W max.

- 332D-G05X1A-01
- 332D-G05X1A-02



2x E27 Led/Hal/Fluo 42W max.

- 332E-G05X1A-01
- 332E-G05X1A-02



3x E27 Led/Hal/Fluo 42W max.

- 332F-G05X1A-01
- 332F-G05X1A-02

### Bases/ Bases

- Base-Vb
- Base-Vn



- Base-Nb
- Base-Nn



- Base-Rb
- Base-Rn



### Anclajes / Anchorages

A02C-004-00  
For -Vb/Vn

A02A-004-00  
For -Nb/Nn

A02B-004-00  
For -Rb/Rn



Acabado blanco o negro / White or black finish

Lamps p.791



Instalar sobre suelo rígido. En césped o tierra, añadir pilastra de cemento.  
Install on rigid ground. On grass or earth, add pilaster cement.



036B-



036A-

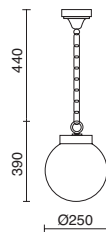
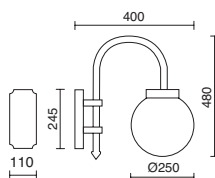

E27 Led/Hal/Fluo 42W max.

036B-G05X1A-01

036B-G05X1A-02



036A-G05X1A-01

036A-G05X1A-02



Acabado blanco o negro / White or black finish

Lamps p.791



Base y anclaje no incluido  
Base and anchor not included



E27 Led/Hal/Fluo 42W max.

036D-G05X1A-01

036D-G05X1A-02



2x E27 Led/Hal/Fluo 42W max.

036E-G05X1A-01

036E-G05X1A-02



3x E27 Led/Hal/Fluo 42W max.

036F-G05X1A-01

036F-G05X1A-02

## Bases/ Bases

Base-Vb

Base-Vn

Base-Nb

Base-Nn

Base-Rb

Base-Rn

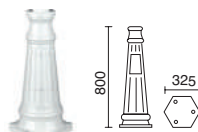
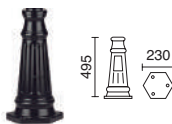

## Anclajes / Anchorages

A02C-004-00

For -Vb/Vn

A02A-004-00

For -Nb/Nn

A02B-004-00

For -Rb/Rn



Acabado blanco o negro / White or black finish

Lamps p.791



Instalar sobre suelo rígido. En césped o tierra, añadir pilastera de cemento.  
Install on rigid ground. On grass or earth, add pilaster cement.

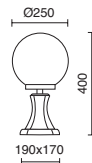

E27 Led/Hal/Fluo 42W max.

O46C-G05X1A-01

O46C-G05X1A-02



E27 Led/Hal/Fluo 42W max.

O46E-G05X1A-01

O46E-G05X1A-02



E27 Led/Hal/Fluo 42W max.

O46G-G05X1A-01

O46G-G05X1A-02

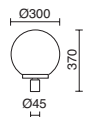

Postes / Poles: p.591

ALU

110V  
240V  
AC



IP  
44



Acabado blanco o negro / White or black finish

Lamps p.791



Instalar sobre suelo rígido. En césped o tierra, añadir pilastera de cemento.  
Install on rigid ground. On grass or earth, add pilaster cement.



Globos no incluidos / Globes not included

Postes / Poles  
h1340

- C07A-11-01
- C07A-11-02

h1710

- C07B-12-01
- C07B-12-02

h2010

- C07C-12-01
- C07C-12-02



Anclajes / Anchorages

A02C-004-00  
For C07A-

A02A-004-00  
For C07B-

A02B-004-00  
For C07C-



Incremento de altura (h400mm)  
Height extension (h400mm)

- A08A-C07-01
- A08A-C07-02

ALU



Acabado blanco o negro / White or black finish



Instalar sobre suelo rígido. En césped o tierra, añadir pilastera de cemento.  
Install on rigid ground. On grass or earth, add pilaster cement.



151A-



057B-

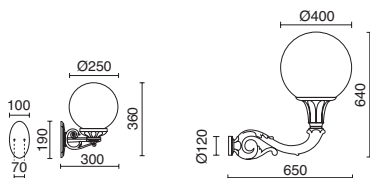

E27 Led/Hal/Fluo 70W max.

■ 151A-G05X1A-02

■ 057B-G05X1A-02



Acabado negro / Black finish

Lamps p.791





E27 Led/Hal/Fluo 70W max.

■ 151H-G05X1A-02

■ 148H-G05X1A-02

■ 151I-G05X1A-02

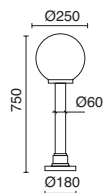

E27 Led/Hal/Fluo 70W max.

■ 145I-G05X1A-02



Acabado negro / Black finish

Lamps p.791



Instalar sobre suelo rígido. En césped o tierra, añadir pilastra de cemento.  
Install on rigid ground. On grass or earth, add pilaster cement.



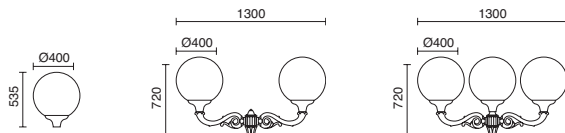

E27 Led/Hal/Fluo 105W max.

■ O57D-G05X1A-02



2x E27 Led/Hal/Fluo 105W max.

■ O57E-G05X1A-02



3x E27 Led/Hal/Fluo 105W max.

■ O57F-G05X1A-02

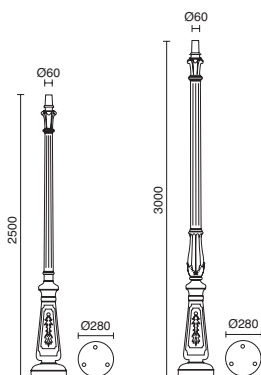

Postes / Poles  
h2500

■ C10A-31-02

h3000

■ C10B-31-02



SEA SIDE SUITABLE



Acabado negro / Black finish

Lamps p.791



Instalar sobre suelo rígido. En césped o tierra, añadir pilastera de cemento.  
Install on rigid ground. On grass or earth, add pilaster cement.

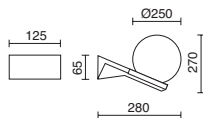

E27 Led/Hal/Fluo 42W max.

■ 344E-G05X1A-02

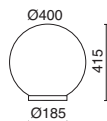
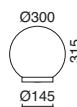

**Ø200**

E27 Led/Hal/Fluo 42W max.

■ 345A-G05X1A-02

**Ø250**

E27 Led/Hal/Fluo 42W max.

■ 345B-G05X1A-02

**Ø300**

E27 Led/Hal/Fluo 42W max.

■ 345C-G05X1A-02

**Ø400**

E27 Led/Hal/Fluo 42W max.

■ 345D-G05X1A-02

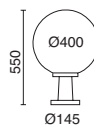
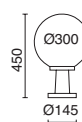
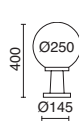

**Ø250**

E27 Led/Hal/Fluo 42W max.

■ 344A-G05X1A-02

**Ø300**

E27 Led/Hal/Fluo 42W max.

■ 344B-G05X1A-02

**Ø400**

E27 Led/Hal/Fluo 42W max.

■ 344C-G05X1A-02



Acabado negro / Black finish

Lamps p.791



Instalar sobre suelo rígido. En césped o tierra, añadir pilastra de cemento.  
Install on rigid ground. On grass or earth, add pilaster cement.



## h310

E27 Led/Hal/Fluo 42W max.

□ 127G-G05X1A-01

■ 127G-G05X1A-02

## h1160

E27 Led/Hal/Fluo 42W max.

□ 127K-G05X1A-01

■ 127K-G05X1A-02



Acabado blanco o negro / White or black finish



Lamps p.791



Instalar sobre suelo rígido. En césped o tierra, añadir pilastra de cemento.  
Install on rigid ground. On grass or earth, add pilaster cement.



O61B-



O61G-

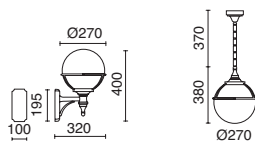

E27 Led/Hal/Fluo 42W max.

□ O61B-G05X1A-01

■ O61B-G05X1A-02



□ O61G-G05X1A-01

■ O61G-G05X1A-02



h400

E27 Led/Hal/Fluo 42W max.

□ O61H-G05X1A-01

■ O61H-G05X1A-02



h1060

E27 Led/Hal/Fluo 42W max.

□ O61I-G05X1A-01

■ O61I-G05X1A-02

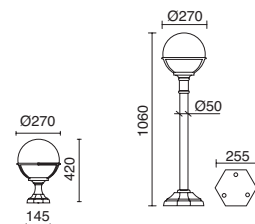

Acabado blanco o negro / White or black finish

Lamps p.791



Instalar sobre suelo rígido. En césped o tierra, añadir pilastro de cemento.  
Install on rigid ground. On grass or earth, add pilaster cement.

# CLIC-CLAC GLOBO

CLASSIC RESIDENTIAL



061J-



061D-

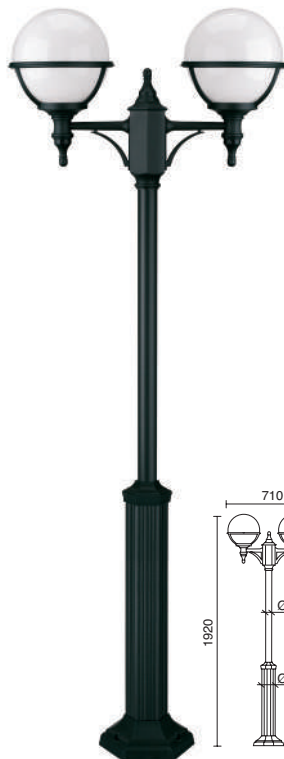

061E-



E27 Led/Hal/Fluo 42W max.

- 061J-G05X1A-01
- 061J-G05X1A-02



E27 Led/Hal/Fluo 42W max.

- 061D-G05X1A-01
- 061D-G05X1A-02



2x E27 Led/Hal/Fluo 42W max.

- 061E-G05X1A-01
- 061E-G05X1A-02



Acabado blanco o negro / White or black finish



Lamps p.791



Instalar sobre suelo rígido. En césped o tierra, añadir pilastra de cemento.  
Install on rigid ground. On grass or earth, add pilaster cement.

# GLOBOS / GLOBES

CLASSIC RESIDENTIAL

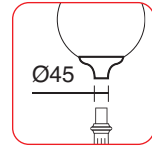
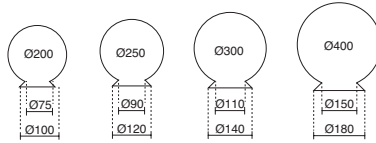

- A23A-128-29 (Ø300)
- A23B-128-29 (Ø400)

- A23C-128-01 (Ø200)
- A23D-128-01 (Ø250)
- A23E-128-01 (Ø300)
- A23F-128-01 (Ø400)

- A23I-128-29 (Ø250)
- A23G-128-29 (Ø300)
- A23H-128-29 (Ø400)

E27 HAL 42W max.		Ø250	Ø300	Ø400	
<input type="checkbox"/>	B12J-G05X1A-01	<input type="checkbox"/>	B12K-G05X1A-01	<input type="checkbox"/>	B12L-G05X1A-01
<input checked="" type="checkbox"/>	B12J-G05X1A-02	<input checked="" type="checkbox"/>	B12K-G05X1A-02	<input checked="" type="checkbox"/>	B12L-G05X1A-02

PA 110V 240V AC

Acabado blanco o negro / White or black finish

Lamps p.791

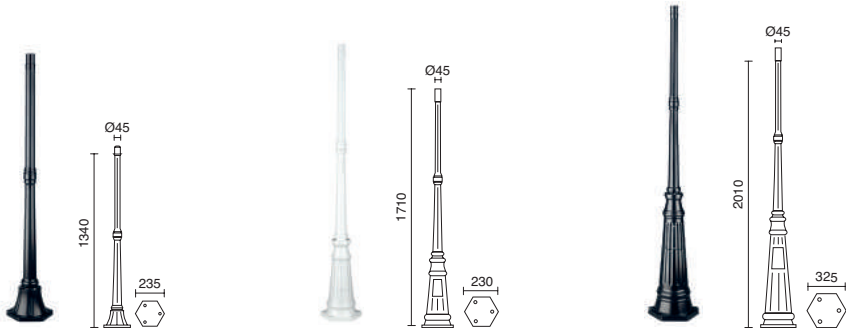

- C07A-11-01
- C07A-11-02
- C07B-12-01
- C07B-12-02
- C07C-12-01
- C07C-12-02

## Anclajes / Anchorages

A02C-004-00

A02A-004-00

A02B-004-00

**Incremento de altura (h400mm)**  
**Height extension (h400mm)**

- A08A-C07-01
- A08A-C07-02

ALU

Acabado blanco o negro / White or black finish

Instalar sobre suelo rígido. En césped o tierra, añadir pilastera de cemento.  
 Install on rigid ground. On grass or earth, add plaster cement.



# GLOBOS / GLOBES

CLASSIC RESIDENTIAL



Cierre hermético  
Hermetic closure

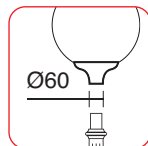
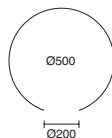

- A22A-128-29 (Ø400)
- A22B-128-29 (Ø500)

- A22C-128-29 (Ø400)
- A22D-128-29 (Ø500)



- A22E-128-01 (Ø400)
- A22F-128-01 (Ø500)

- A22G-128-29 (Ø400)
- A22H-128-29 (Ø500)



E27 HAL 70W max.

- B12A-G05X1A-02



E27 HAL 70W max.

- B12M-G05X1A-02

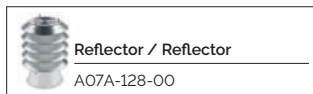

PA



Acabado negro / Black finish

Lamps p.791



Bayoneta  
Bayonet

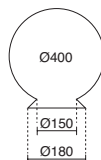
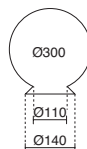
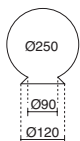

- A23A-128-29 (Ø300)
- A23B-128-29 (Ø400)

- A23D-128-01 (Ø250)
- A23E-128-01 (Ø300)
- A23F-128-01 (Ø400)

- A23I-128-29 (Ø250)
- A23G-128-29 (Ø300)
- A23H-128-29 (Ø400)



E27 HAL 70W max.

- B12F-G05X1A-02 (Ø250)
- B12G-G05X1A-02 (Ø300)
- B12H-G05X1A-02 (Ø400)

PA



Acabado negro / Black finish

Lamps p.791

# POSTES / POLES

CLASSIC RESIDENTIAL

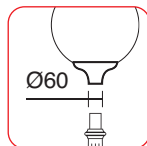
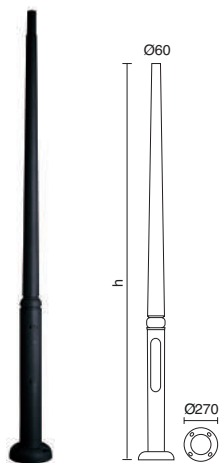
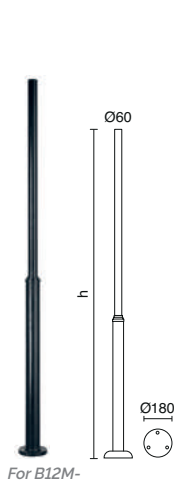

- C06A-31-02 (h2000)
- C06B-31-02 (h2400)

- C04A-32-02 (h3000)
- C04B-32-02 (h3500)
- C04C-32-02 (h4000)
- C04D-32-02 (h4500)
- C04E-32-02 (h5000)

RESIN



SEA SIDE  
SUITABLE



Acabado negro / Black finish



Instalar sobre suelo rígido. En césped o tierra, añadir pilastra de cemento.  
Install on rigid ground. On grass or earth, add plaster cement.

# POSTES / POLES

CLASSIC RESIDENTIAL

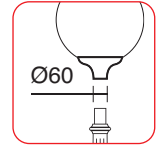
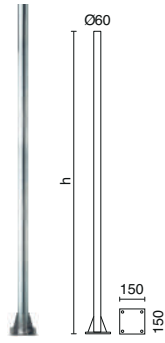
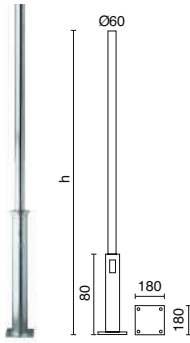

Es necesario pintar  
It is necessary to paint

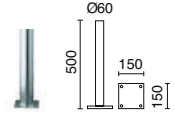

■ C30E-32-38 (h2500)  
■ C30F-32-38 (h3000)

■ C30D-31-38 (h2000)  
■ C30E-31-38 (h2500)  
■ C30F-31-38 (h3000)

■ C30B-31-38



Anclajes / Anchorages

A02G-004-00

A02F-004-00

ACER

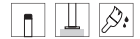

Acabado acero cincado / Zinc-plated Steel finish

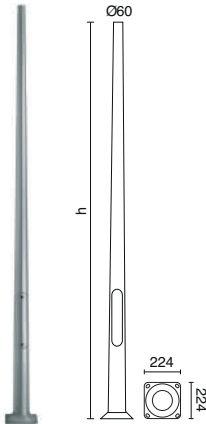

Caja de conexión opcional  
Optional junction box

500V 80A D01/E14-16A (273x90x76cm)

B03F-X33X1A-29



Anclaje / Anchorage

A02D-004-00

■ C02B-32-02 (h3000)  
■ C02C-32-02 (h3500)  
■ C02D-32-02 (h4000)  
■ C02F-32-02 (h5000)

■ C03B-32-39 (h3000)  
■ C03C-32-39 (h3500)  
■ C03D-32-39 (h4000)  
■ C03F-32-39 (h5000)

ALU  
ANOD



Acabado negro o aluminio anodizado / Black or anodised aluminium finish



Instalar sobre suelo rígido. En césped o tierra, añadir pilastra de cemento.  
Install on rigid ground. On grass or earth, add pilaster cement.

# GLOBOS / GLOBES

CLASSIC RESIDENTIAL

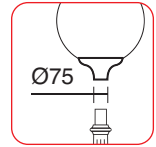

PMMA PRISM

A23B-128-29



PMMA OPAL

A23F-128-01



PMMA TRANS

A23H-128-29

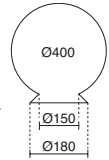

E27 HAL 70W max.

B12I-G05X1A-02

PA



Acabado negro / Black finish

Lamps p.791

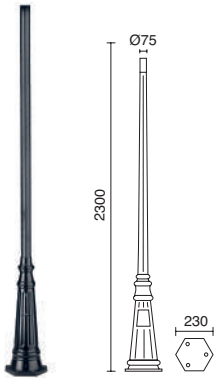

C07D-42-02 (h2300)

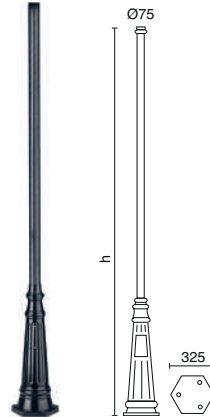

C07E-42-02 (h2600)

C07F-42-02 (h2900)



Anclajes / Anchorages

A02A-004-00

For C07D-

A02B-004-00

For C07E- / C07F-

ALU



Acabado negro / Black finish

Lamps p.791



Instalar sobre suelo rígido. En césped o tierra, añadir pilastra de cemento.  
Install on rigid ground. On grass or earth, add pilaster cement.

# ROUND

CLASSIC RESIDENTIAL



405C-



405D-

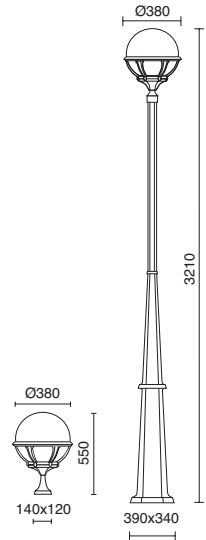

E27 Led/Hal/Fluo 105W max.

■ 405C-G05X1A-04



■ 405D-G05X1A-04



Anclajes / Anchorages

A02A-406-00



Reflector antideslumbrantes  
Anti-glare reflector

A07A-406-39



Acabado antracita / Anthracite finish

Lamps p.791



Instalar sobre suelo rígido. En césped o tierra, añadir pilastra de cemento.  
Install on rigid ground. On grass or earth, add pilaster cement.



406C-



406D-



140x120

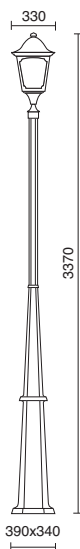

390x340

E27 Led/Hal/Fluo 105W max.

■ 406C-G05X1A-04



■ 406D-G05X1A-04



Anclajes / Anchorages

A02A-406-00



Reflector antideslumbrantes  
Anti-glare reflector

A07A-406-39



Acabado antracita / Anthracite finish

Lamps p.791



Instalar sobre suelo rígido. En césped o tierra, añadir pilastra de cemento.  
Install on rigid ground. On grass or earth, add pilaster cement.



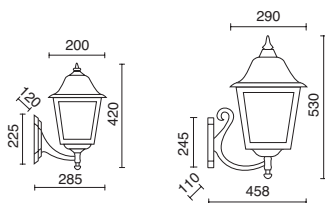

**L200**  
E27 Led/Hal/Fluo 42W max.

**L290**  
E27 Led/Hal/Fluo 70W max.

- 264C-G05X1A-01
- 264C-G05X1A-02

- 264E-G05X1A-01
- 264E-G05X1A-02

- 264D-G05X1A-01
- 264D-G05X1A-02

For 264C- & 264D-



**Adaptador de esquina**  
**Corner adaptor**

- A06A-004-01
- A06A-004-02

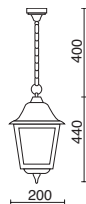

E27 Led/Hal/Fluo 42W max.

- 264A-G05X1A-01
- 264A-G05X1A-02

- 264B-G05X1A-01
- 264B-G05X1A-02

ALU



Acabado blanco o negro / White or black finish

Lamps p.791



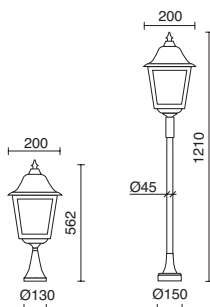

### h562

E27 Led/Hal/Fluo 42W max.



□ 264G-G05X1A-01

■ 264G-G05X1A-02



□ 264H-G05X1A-01

■ 264H-G05X1A-02

### h1210

E27 Led/Hal/Fluo 42W max.

□ 264K-G05X1A-01

■ 264K-G05X1A-02

□ 264L-G05X1A-01

■ 264L-G05X1A-02

ALU



Acabado blanco o negro / White or black finish

Lamps p.791



Instalar sobre suelo rígido. En césped o tierra, añadir pilastra de cemento.  
Install on rigid ground. On grass or earth, add pilaster cement.

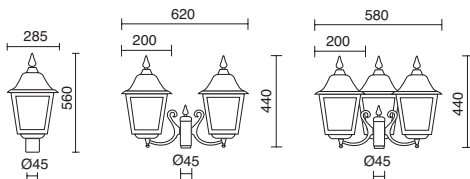

E27 Led/Hal/Fluo 70W max.



2x E27 Led/Hal/Fluo 42W max.



3x E27 Led/Hal/Fluo 42W max.



- 264M-G05X1A-01
- 264M-G05X1A-02



- 264O-G05X1A-01
- 264O-G05X1A-02



- 264Q-G05X1A-01
- 264Q-G05X1A-02



- 264N-G05X1A-01
- 264N-G05X1A-02



- 264P-G05X1A-01
- 264P-G05X1A-02



- 264R-G05X1A-01
- 264R-G05X1A-02



ALU



110V  
240V  
AC



IP  
44



Acabado blanco o negro / White or black finish

Lamps p.791



**Incremento de altura (h400mm)**  
**Height extension (h400mm)**

□ A08A-C07-01  
 ■ A08A-C07-02

- C07A-11-01
- C07A-11-02



**Anclajes / Anchorages**

A02C-004-00

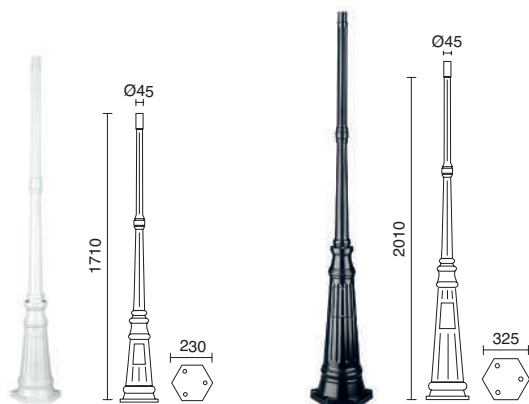

**Incremento de altura (h400mm)**  
**Height extension (h400mm)**

□ A08A-C07-01  
 ■ A08A-C07-02

- C07B-12-01
- C07B-12-02

- C07C-12-01
- C07C-12-02



**Anclajes / Anchorages**

A02A-004-00

For C07B-

A02B-004-00

For C07C-

ALU



Acabado blanco o negro / White or black finish

Lamps p.791



Instalar sobre suelo rígido. En césped o tierra, añadir pilastra de cemento.  
 Install on rigid ground. On grass or earth, add pilaster cement.

# CLIC-CLAC 4

CLASSIC RESIDENTIAL



059A-



059B-

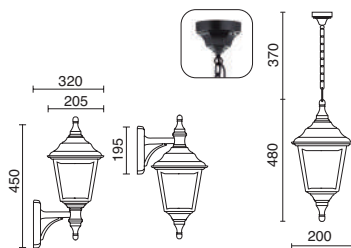

E27 Led/Hal/Fluo 42W max.

- 059A-G05X1A-01
- 059A-G05X1A-02



- 059G-G05X1A-01
- 059G-G05X1A-02



h430

E27 Led/Hal/Fluo 42W max.

- 059H-G05X1A-01
- 059H-G05X1A-02



h1160

E27 Led/Hal/Fluo 42W max.

- 059I-G05X1A-01
- 059I-G05X1A-02

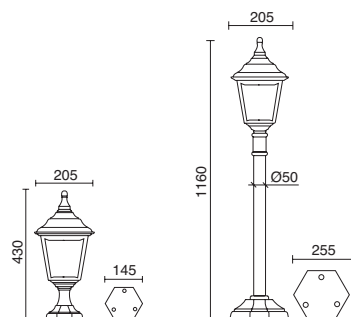

Acabado blanco o negro / White or black finish

Lamps p.791



Instalar sobre suelo rígido. En césped o tierra, añadir pilastra de cemento.  
Install on rigid ground. On grass or earth, add pilaster cement.

# CLIC-CLAC 4

CLASSIC RESIDENTIAL

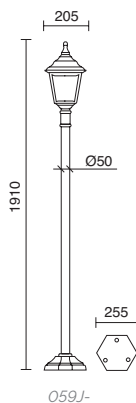

059J-

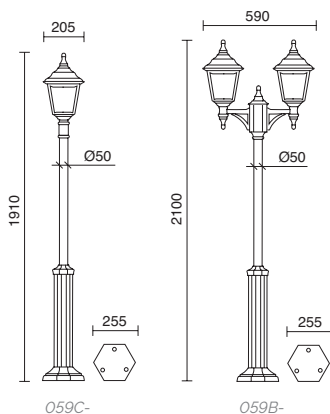
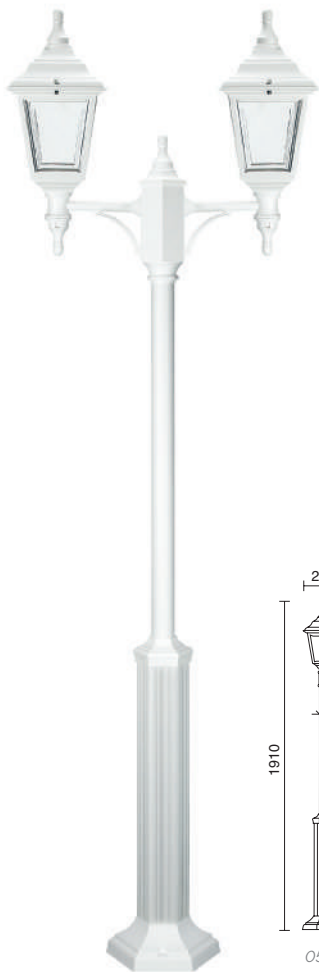

059C-

059B-



E27 Led/Hal/Fluo 42W max.

- 059J-G05X1A-01
- 059J-G05X1A-02



E27 Led/Hal/Fluo 42W max.

- 059C-G05X1A-01
- 059C-G05X1A-02



E27 Led/Hal/Fluo 2x 42W max.

- 059B-G05X1A-01
- 059B-G05X1A-02



Acabado blanco o negro / White or black finish



Lamps p.791



Instalar sobre suelo rígido. En césped o tierra, añadir pilastra de cemento.  
Install on rigid ground. On grass or earth, add pilaster cement.

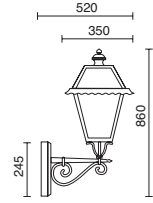

E27 Led/Hal/Fluo 70W max.

■ 348B-G05X1A-02



E27 Led/Hal/Fluo 70W max.

■ 348D-G05X1A-02

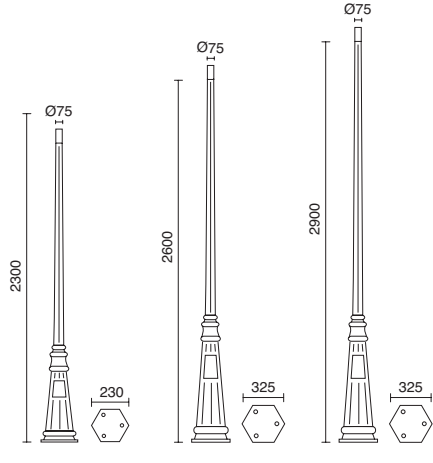
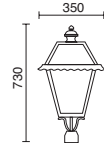

Postes / Poles  
h2300

■ C07D-42-02

h2600

■ C07E-42-02

h2900

■ C07F-42-02



Anclajes / Anchorages

A02A-004-00  
For C07D-

A02B-004-00  
For C07E- / C07F-

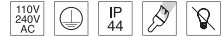

Acabado negro / Black finish

Lamps p.791



Instalar sobre suelo rígido. En césped o tierra, añadir pilastra de cemento.  
Install on rigid ground. On grass or earth, add pilaster cement.

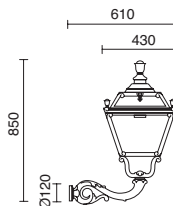

E27 Led/Hal/Fluo 70W max.

■ 056B-G05X1A-02



E27 Led/Hal/Fluo 70W max.

■ 056D-G05X1A-02

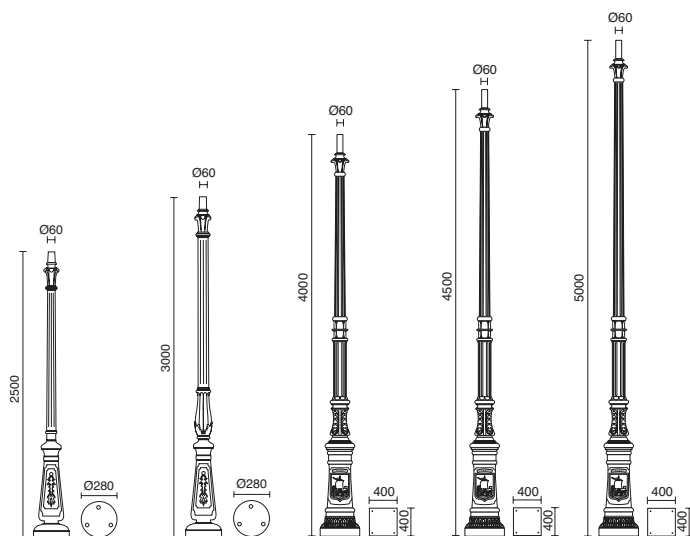
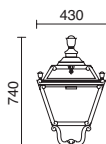

Postes / Poles  
h2500

h3000

h4000

h4500

h5000

■ C10A-31-02

■ C10B-31-02

■ C12A-32-02

■ C12B-32-02

■ C12C-32-02



Acabado negro / Black finish

Lamps p.791



Instalar sobre suelo rígido. En césped o tierra, añadir pilastro de cemento.  
Install on rigid ground. On grass or earth, add pilaster cement.

# INDURA MEDIUM 4

CLASSIC RESIDENTIAL



146B-



146H-

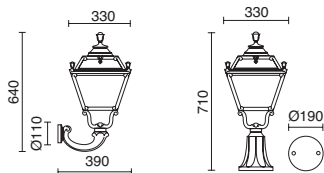

E27 Led/Hal/Fluo 42W max.

■ 146B-G05X1A-02

■ 146H-G05X1A-02

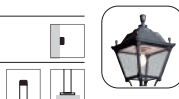

E27 (Basket diffuser)

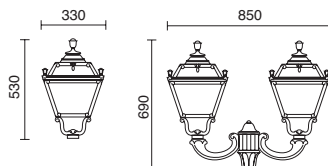

E27 Led/Hal/Fluo 70W max.

■ 146D-G05X1A-02



2x E27 Led/Hal/Fluo 70W max.

■ 146E-G05X1A-02



E27 (Basket diffuser)

GX53 LED T2 4x 10W

■ 146D-G31X1A-02

2x GX53 LED T2 4x 10W

■ 146E-G31X1A-02



GX53 (Flat diffuser)

No es posible Kit de sustitución LED. La luminaria está construida específicamente para portalámparas GX53.

Substitution LED KIT not available. Fitting is meant for GX53 lamp holder.



Acabado negro / Black finish

Lamps p.791



# INDURA MEDIUM 4

CLASSIC RESIDENTIAL

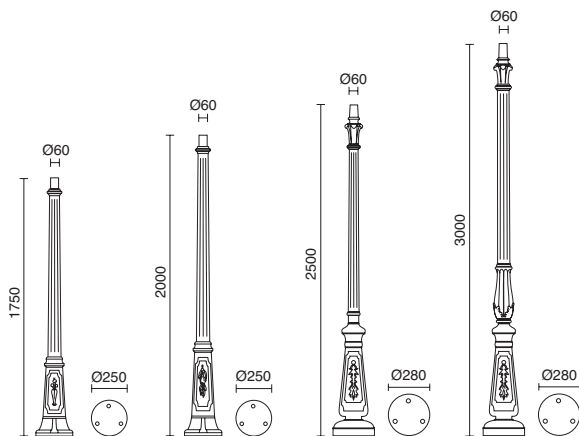

Postes / Poles  
h1750

■ C08B-31-02

h2000

■ C08C-31-02

h2500

■ C10A-31-02

h3000

■ C10B-31-02

RESIN



Acabado negro / Black finish

Lamps p.791



Instalar sobre suelo rígido. En césped o tierra, añadir pilastra de cemento.  
Install on rigid ground. On grass or earth, add pilaster cement.

# INDURA MINI 4

CLASSIC RESIDENTIAL



149B-

149G-



Doble posición  
Double position

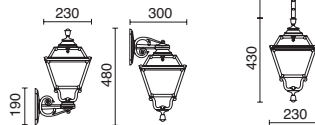

E27 Led/Hal/Fluo 42W max.

■ 149B-G05X1A-02



■ 149G-G05X1A-02



h480

E27 Led/Hal/Fluo 42W max.



h1100

E27 Led/Hal/Fluo 42W max.

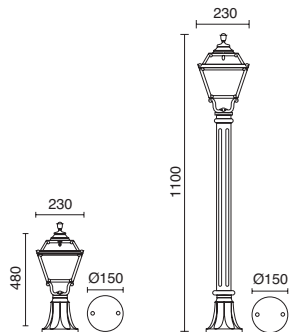

■ 149H-G05X1A-02

■ 149I-G05X1A-02



Acabado negro / Black finish

Lamps p.791



Instalar sobre suelo rígido. En césped o tierra, añadir pilastera de cemento.  
Install on rigid ground. On grass or earth, add pilaster cement.

# INDURA MINI 6

CLASSIC RESIDENTIAL

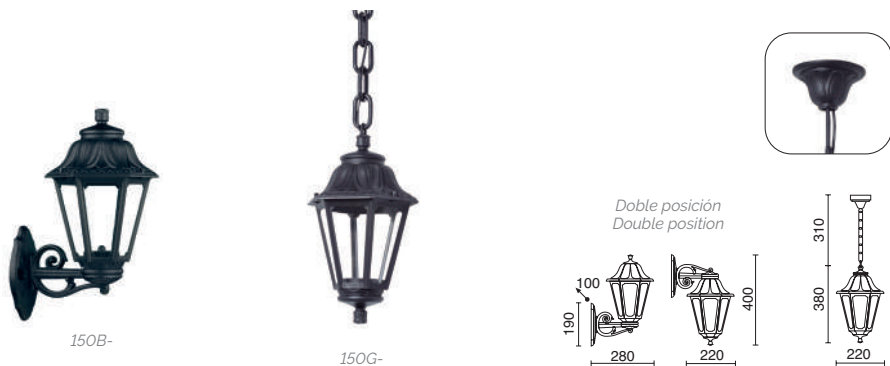

E27 Led/Hal/Fluo 42W max.

■ 150B-G05X1A-02

■ 150G-G05X1A-02



h390

E27 Led/Hal/Fluo 42W max.

■ 150H-G05X1A-02

h1100

E27 Led/Hal/Fluo 42W max.

■ 150I-G05X1A-02



Acabado negro / Black finish

Lamps p.791

 Instalar sobre suelo rígido. En césped o tierra, añadir pilastra de cemento.  
Install on rigid ground. On grass or earth, add pilaster cement.

# INDURA MEDIUM 6

CLASSIC RESIDENTIAL



147A-



147B-

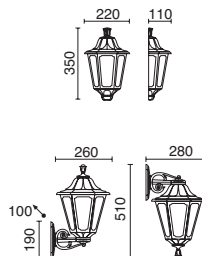

E27 Led/Hal/Fluo 42W max.

■ 147A-G05X1A-02

■ 147B-G05X1A-02



h530

E27 Led/Hal/Fluo 42W max.

■ 147H-G05X1A-02



h1150

E27 Led/Hal/Fluo 42W max.

■ 147I-G05X1A-02

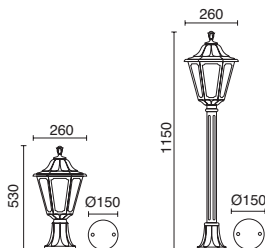

Acabado negro / Black finish

Lamps p.791



Instalar sobre suelo rígido. En césped o tierra, añadir pilastro de cemento.  
Install on rigid ground. On grass or earth, add pilaster cement.

# INDURA MEDIUM 6

CLASSIC RESIDENTIAL

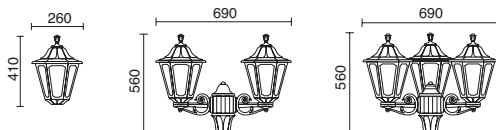

↑  
h410  
E27 Led/Hal/Fluo 42W max.

■ 147D-G05X1A-02

↑↑  
h560  
2x E27 Led/Hal/Fluo 42W max.

■ 147E-G05X1A-02

↑↑↑  
h560  
3x E27 Led/Hal/Fluo 42W max.

■ 147F-G05X1A-02

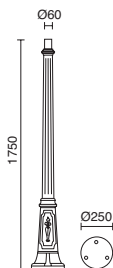

Postes / Poles  
h1750

■ C08B-31-02

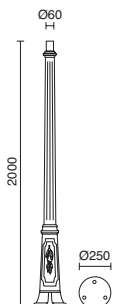

h2000

■ C08C-31-02



Acabado negro / Black finish

Lamps p.791



Instalar sobre suelo rígido. En césped o tierra, añadir pilastra de cemento.  
Install on rigid ground. On grass or earth, add pilaster cement.

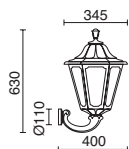

E27 Led/Hal/Fluo 42W max.

■ 144B-G05X1A-02

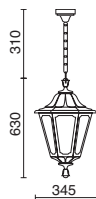

E27 Led/Hal/Fluo 42W max.

■ 144G-G05X1A-02



Acabado negro / Black finish

Lamps p.791

# INDURA BIG 6

CLASSIC RESIDENTIAL

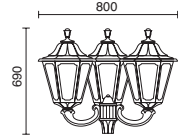
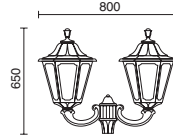
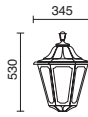

E27 Led/Hal/Fluo 70W max.

■ 144D-G05X1A-02



E27 Led/Hal/Fluo 2x 70W max.

■ 144E-G05X1A-02



E27 Led/Hal/Fluo 3x 70W max.

■ 144F-G05X1A-02

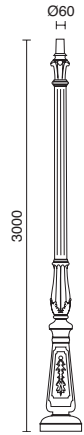
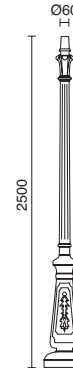
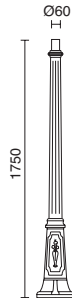

Postes / Poles  
h1750

■ C08B-31-02

h2000

■ C08C-31-02

h2500

■ C10A-31-02

h3000

■ C10B-31-02



Acabado negro / Black finish

Lamps p.791



Instalar sobre suelo rígido. En césped o tierra, añadir pilastra de cemento.  
Install on rigid ground. On grass or earth, add pilaster cement.

# CLIC-CLAC 6

CLASSIC RESIDENTIAL



O60A-



O60B-

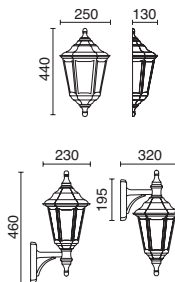

**h440**

E27 Led/Hal/Fluo 42W max.

O60A-G05X1A-01

O60A-G05X1A-02

**h460**

E27 Led/Hal/Fluo 42W max.

O60B-G05X1A-01

O60B-G05X1A-02



O60G-



O60H-

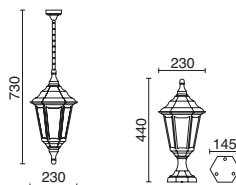

E27 Led/Hal/Fluo 42W max.

O60G-G05X1A-01

O60G-G05X1A-02



O60H-G05X1A-01

O60H-G05X1A-02



Acabado blanco o negro / White or black finish

Lamps p.791



Instalar sobre suelo rígido. En césped o tierra, añadir pilastra de cemento.  
Install on rigid ground. On grass or earth, add pilaster cement.



# CLIC-CLAC 6

CLASSIC RESIDENTIAL



O60J-

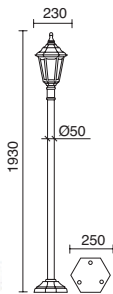

O60D-

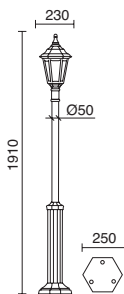

O60E-

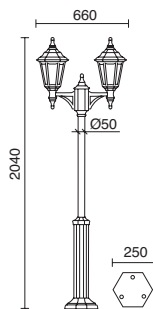

**h1930**

E27 Led/Hal/Fluo 42W max.

□ O60J-G05X1A-01

■ O60J-G05X1A-02



**h1910**

E27 Led/Hal/Fluo 42W max.

□ O60D-G05X1A-01

■ O60D-G05X1A-02



**h2040**

E27 Led/Hal/Fluo 2x 42W max.

□ O60E-G05X1A-01

■ O60E-G05X1A-02



Acabado blanco o negro / White or black finish

Lamps p.791



Instalar sobre suelo rígido. En césped o tierra, añadir pilastra de cemento.  
Install on rigid ground. On grass or earth, add pilaster cement.

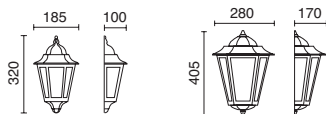

**h320**

E14 Led/Hal/Fluo 42W max.

**h405**

E27 Led/Hal/Fluo 42W max.



- 096A-G04X1A-01
- 096A-G04X1A-02

- 096D-G05X1A-01
- 096D-G05X1A-02



- 096E-G05X1A-01
- 096E-G05X1A-02

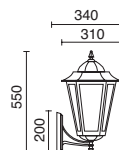
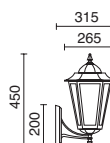
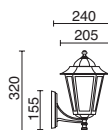

**h320**

E14 Led/Hal/Fluo 42W max.

**h450**

E27 Led/Hal/Fluo 42W max.

**h550**

E27 Led/Hal/Fluo 42W max.



- 096F-G05X1A-01
- 096F-G05X1A-02

- 096G-G05X1A-01
- 096G-G05X1A-02

- 096I-G05X1A-01
- 096I-G05X1A-02



- 096H-G05X1A-01
- 096H-G05X1A-02

- 096J-G05X1A-01
- 096J-G05X1A-02

For h450 & h550



**Adaptador de esquina**  
**Corner adaptor**

- A06A-004-01
- A06A-004-02

ALU



Acabado blanco o negro / White or black finish

Lamps p.791

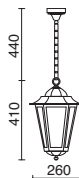

E27 Led/Hal/Fluo 70W max.



- 096B-G05X1A-01
- 096B-G05X1A-02



- 096C-G05X1A-01
- 096C-G05X1A-02

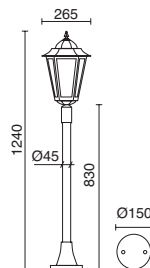
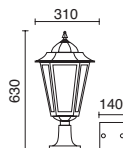

**h520**

E27 Led/Hal/Fluo 42W max.



- 096K-G05X1A-01
- 096K-G05X1A-02

**h620**

E27 Led/Hal/Fluo 42W max.

- 096M-G05X1A-01
- 096M-G05X1A-02

**h1240**

E27 Led/Hal/Fluo 42W max.

- 096O-G05X1A-01
- 096O-G05X1A-02



- 096L-G05X1A-01
- 096L-G05X1A-02

- 096N-G05X1A-01
- 096N-G05X1A-02

- 096P-G05X1A-01
- 096P-G05X1A-02

ALU



Acabado blanco o negro / White or black finish

Lamps p.791



Instalar sobre suelo rígido. En césped o tierra, añadir pilastra de cemento.  
Install on rigid ground. On grass or earth, add pilaster cement.

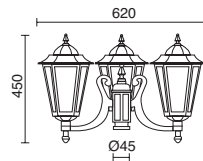
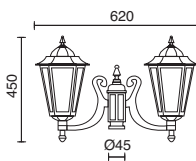

E27 Led/Hal/Fluo 42W max.



2x E27 Led/Hal/Fluo 42W max.



3x E27 Led/Hal/Fluo 42W max.



□ 096Q-G05X1A-01  
■ 096Q-G05X1A-02

□ 096S-G05X1A-01  
■ 096S-G05X1A-02

□ 096U-G05X1A-01  
■ 096U-G05X1A-02



□ 096R-G05X1A-01  
■ 096R-G05X1A-02

□ 096T-G05X1A-01  
■ 096T-G05X1A-02

□ 096V-G05X1A-01  
■ 096V-G05X1A-02



ALU



110V  
240V  
AC



IP  
44



Acabado blanco o negro / White or black finish

Lamps p.791

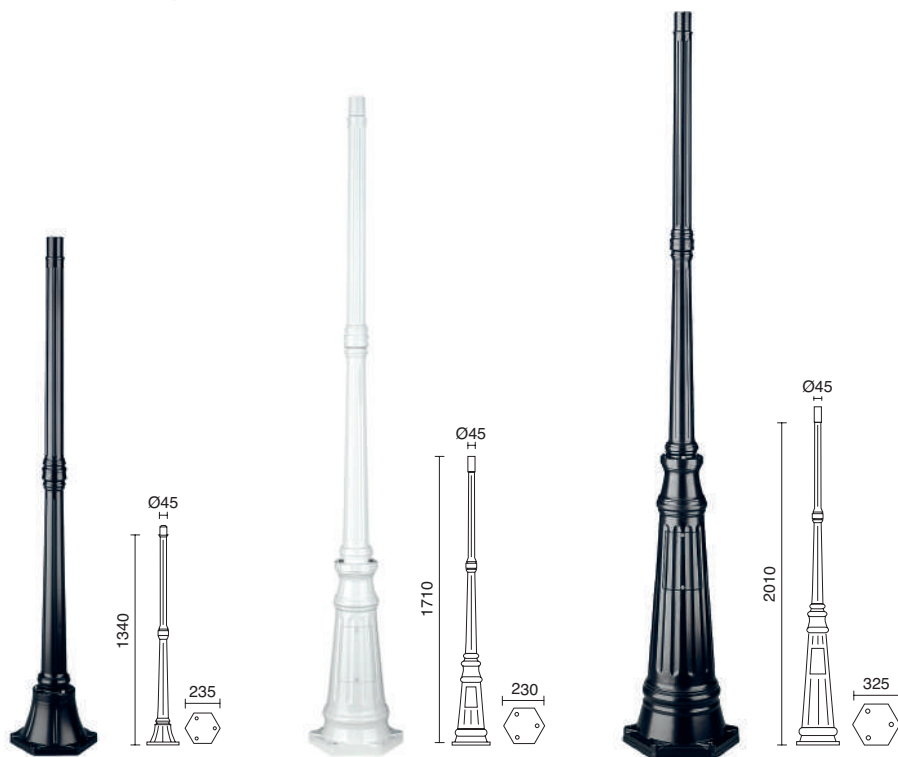

□ C07A-11-01  
 ■ C07A-11-02

□ C07B-12-01  
 ■ C07B-12-02

□ C07C-12-01  
 ■ C07C-12-02



## Anclajes / Anchorages

A02C-004-00

For C07A-

A02A-004-00

For C07B- / C07C-

A02B-004-00

For C07B- / C07C-



**Incremento de altura (h400mm)**  
**Height extension (h400mm)**

□ A08A-C07-01  
 ■ A08A-C07-02

ALU



Acabado blanco o negro / White or black finish

Lamps p.791



Instalar sobre suelo rígido. En césped o tierra, añadir pilastera de cemento.  
 Install on rigid ground. On grass or earth, add pilaster cement.

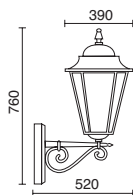

E27 Led/Hal/Fluo 70W max.

■ 346B-G05X1A-02



Acabado negro / Black finish

Lamps p.791

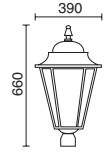

E27 Led/Hal/Fluo 70W max.

■ 346D-G05X1A-02

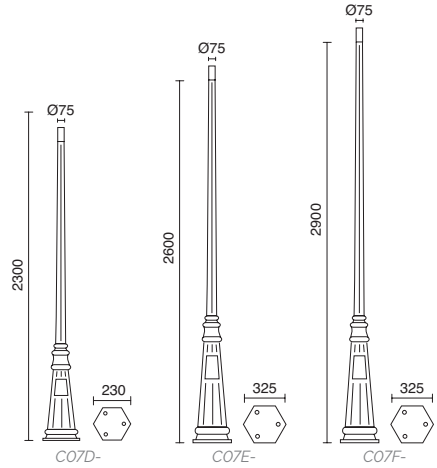

Postes / Poles  
h2300

h2600

h2900

■ C07D-42-02

■ C07E-42-02

■ C07F-42-02



Anclajes / Anchorages

A02A-004-00

A02B-004-00

For C07D-

For C07E- / C07F-



Acabado negro / Black finish

Lamps p.791



Instalar sobre suelo rígido. En césped o tierra, añadir pilastra de cemento.  
Install on rigid ground. On grass or earth, add pilaster cement.

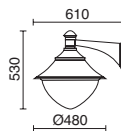

GX53 LED T2 (6x 10W)

■ 407B-G31X1A-02



Acabado negro / Black finish

Lamps p.790



# GUNTHER Ø48

CLASSIC RESIDENTIAL

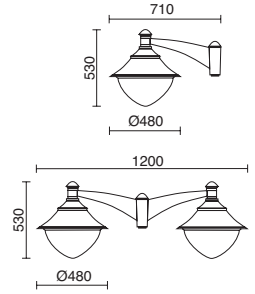

GX53 LED T2 (6x 10W)

■ 407D-G31X1A-02



2x GX53 LED T2 (6x 10W)

■ 407E-G31X1A-02

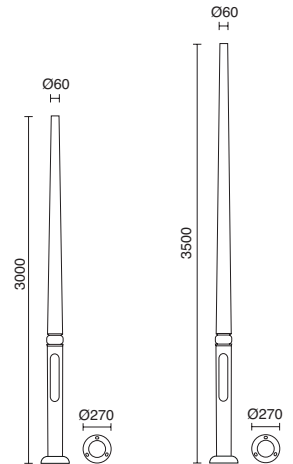

Postes / Poles  
h3000

■ C04A-32-02

h3500

■ C04B-32-02



Acabado negro / Black finish

Lamps p.790



Instalar sobre suelo rígido. En césped o tierra, añadir pilastra de cemento.  
Install on rigid ground. On grass or earth, add pilaster cement.

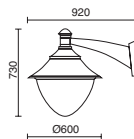

GX53 LED T2 (9x 10W)

■ 408B-G31X1A-02

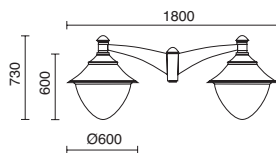
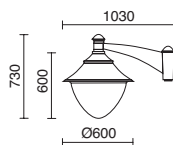

GX53 LED T2 (9x 10W)

■ 408D-G31X1A-02



2x GX53 LED T2 (9x 10W)

■ 408E-G31X1A-02



Postes / Poles: p.635



# GUNTHER TOP

CLASSIC RESIDENTIAL



655A-G31X1A-02 + C04D-32-02

GX53 LED T2 (9x 10W)

■ 655A-G31X1A-02

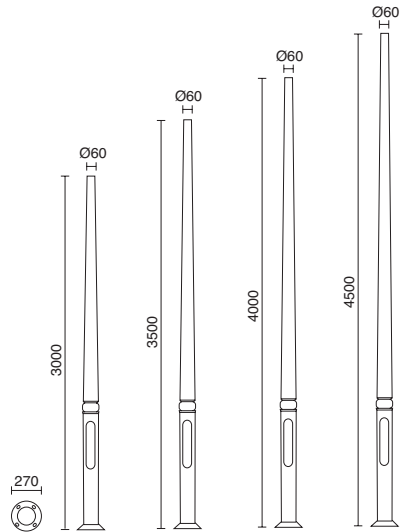
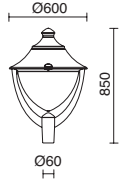
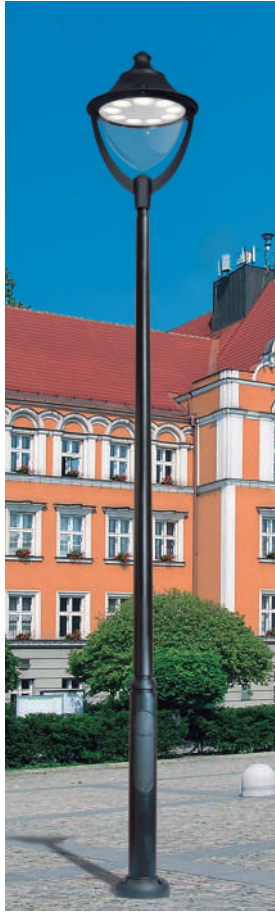

Postes / Poles  
h3000

■ C04A-32-02

h3500

■ C04B-32-02

h4000

■ C04C-32-02

h4500

■ C04D-32-02



Acabado negro / Black finish

Lamps p.790



Instalar sobre suelo rígido. En césped o tierra, añadir pilastra de cemento.  
Install on rigid ground. On grass or earth, add pilaster cement.

# ARCHITECTURE OUTDOOR

CTURAL  
OR

**Cristher** lighting



Wall  
lights



**2700K**  
LED SMD 11W 1420lm

■ 1069A-L3011FCO-04

**3000K**  
LED SMD 11W 1420lm

■ 1069A-L3111FCO-04

**4000K**  
LED SMD 11W 1510lm

■ 1069A-L3311FCO-04



Acabado antracita / Anthracite finish

Drivers p. 794-795

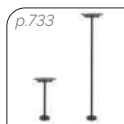



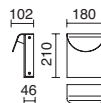

LED SMD 8,5W 1500lm 3000K

- 926D-L3109B-80
- 926D-L3109B-81
- 926D-L3109B-82
- 926D-L3109B-83



Acabado antracita / Anthracite finish

Neolight Nero Zimbabwe

Neolight Phedra Satin

Neolight Iron Moss Satin

Neolight La Bohème NH



-80



-81



-82



-83







965A-

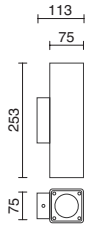

965B-

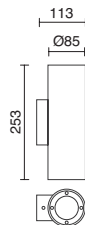

□ GU10 2x 12W max.

○ GU10 2x 12W max.

- 965A-G21X1A-NB
- 965A-G21X1A-NN
- 965A-G21X1A-NR
- 965A-G21X1A-NW

- 965B-G21X1A-NB
- 965B-G21X1A-NN
- 965B-G21X1A-NR
- 965B-G21X1A-NW



Lamps p. 792

Antracita / Anthracite

Natural / Natural

Rojo / Red

Blanco / White



-NB



-NN

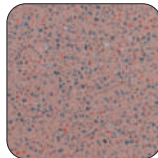

-NR



-NW



Conector IP67 incluido  
IP67 connector included

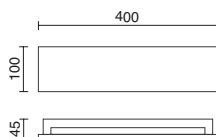
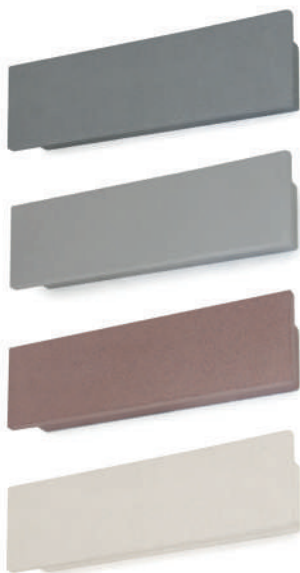

LED SMD 10W 2x 475lm 3000K

- 965C-L3112A-NB
- 965C-L3112A-NN
- 965C-L3112A-NR
- 965C-L3112A-NW

Adaptable a iluminación mono emisión.  
Adaptable to mono emission lighting.



Antracita / Anthracite

Natural / Natural

Rojo / Red

Blanco / White

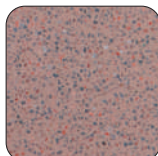

-NB

-NN

-NR

-NW

p.643



p.673



p.713



p.735



Conector IP67 incluido  
IP67 connector included



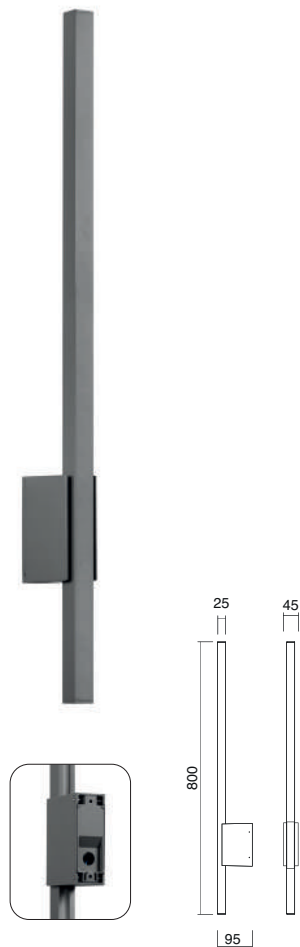

**3000K**  
LED SMD 10,5W 1150lm

■ 1024B-L3112BXO-04

■ 1024B-L3112BXD-04

**4000K**  
LED SMD 10,5W 1280lm

■ 1024B-L3312BXO-04

■ 1024B-L3312BXD-04



Acabado antracita / Anthracite finish

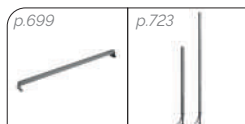

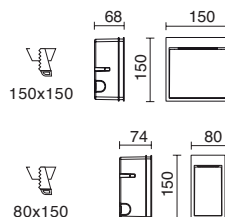

### L150

LED SMD 9W 1000lm 3000K

- 929A-L3109B-01
- 929A-L3109B-02
- 929A-L3109B-03
- 929A-L3109B-90

### L80

LED SMD 4,5W 500lm 3000K

- 929B-L3105B-01
- 929B-L3105B-02
- 929B-L3105B-03
- 929B-L3105B-90

Reflector decorativo opcional / Optional decorative reflector

- A13A-929-01
- A13A-929-02
- A13A-929-03
- A13A-929-47
- A13A-929-90

- A13B-929-01
- A13B-929-02
- A13B-929-03
- A13B-929-47
- A13B-929-90



Acabado blanco, negro, gris o marrón óxido / White, black, grey or oxide brown finish



Disponible en 91°  
Available in 91°



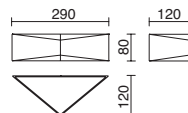

E27 LED 10W max. 680lm 3000K

- 659A-G05X1A-04
- 659A-G05X1A-11
- 659A-G05X1A-90



Acabado antracita, marfil o marrón óxido / Anthracite, ivory or oxide brown finish

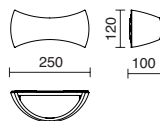

**3000K**  
LED SMD 12W 2x 990lm

■ 931A-L3117B-04  
■ 931A-L3117B-90

**4000K**  
LED SMD 12W 2x 1037lm

■ 931A-L3317B-04  
■ 931A-L3317B-90

■ 931A-L31RDB-04  
■ 931A-L31RDB-90

■ 931A-L33RDB-04  
■ 931A-L33RDB-90



Acabado antracita o marrón óxido / Anthracite or oxide brown finish

Consultar opciones de regulación.  
Consult regulation options.

Consultar otras opciones de acabado  
Consult other finishing options



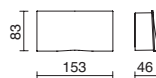

LED COB 6.5W 850lm 3000K

- 483B-L0107B-01
- 483B-L0107B-03

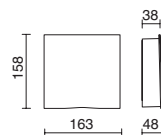

LED COB 12W 1800lm 3000K

- 483A-L0112B-01
- 483A-L0112B-03

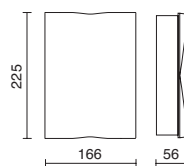

LED COB 52W 2x 3400lm 3000K



LED COB 42W 2x 2800lm 3000K

- 483C-L01C1B-01
- 483C-L01C1B-03

- 483C-L01RDB-01
- 483C-L01RDB-03



ALU



Acabado blanco o gris / White or grey finish





### 2700K

LED COB AC 4W 315lm

- 157A-L3805B-01
- 157A-L3805B-02
- 157A-L3805B-03
- 157A-L3805B-04
- 157A-L3805B-91

2x LED COB AC 4W 315lm

- 157B-L38G8B-01
- 157B-L38G8B-02
- 157B-L38G8B-03
- 157B-L38G8B-04
- 157B-L38G8B-91

### 3000K

LED COB AC 4W 345lm

- 157A-L0105B-01
- 157A-L0105B-02
- 157A-L0105B-03
- 157A-L0105B-04
- 157A-L0105B-91

2x LED COB AC 4W 345lm

- 157B-L01G8B-01
- 157B-L01G8B-02
- 157B-L01G8B-03
- 157B-L01G8B-04
- 157B-L01G8B-91

### 4000K

LED COB AC 4W 355lm

- 157A-L0205B-01
- 157A-L0205B-02
- 157A-L0205B-03
- 157A-L0205B-04
- 157A-L0205B-91

2x LED COB AC 4W 355lm

- 157B-L02G8B-01
- 157B-L02G8B-02
- 157B-L02G8B-03
- 157B-L02G8B-04
- 157B-L02G8B-91



Acabado blanco, negro, gris, antracita o marrón cobrizo / White, black, grey, anthracite or copper brown finish

G9 Hal. 40W max.

- 157A-H20X1A-01
- 157A-H20X1A-02
- 157A-H20X1A-03
- 157A-H20X1A-04
- 157A-H20X1A-91



- 157B-H20X1A-01
- 157B-H20X1A-02
- 157B-H20X1A-03
- 157B-H20X1A-04
- 157B-H20X1A-91



Acabado blanco, negro, gris, antracita o marrón cobrizo / White, black, grey, anthracite or copper brown finish

Lamps p. 792



E27 (Ø54mm) 20W max.

- 157C-G05X1A-01
- 157C-G05X1A-02
- 157C-G05X1A-03
- 157C-G05X1A-04
- 157C-G05X1A-91



E27 (Ø54mm) 20W max.

- 157D-G05X1A-01
- 157D-G05X1A-02
- 157D-G05X1A-03
- 157D-G05X1A-04
- 157D-G05X1A-91

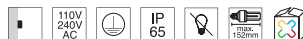

Acabado blanco, negro, gris, antracita o marrón cobrizo / White, black, grey, anthracite or copper brown finish

Lamps p. 791

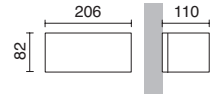

### 2700K

LED SMD 6W 950lm

- 157C-L3006B-01
- 157C-L3006B-02
- ▒ 157C-L3006B-03
- ▒ 157C-L3006B-04
- 157C-L3006B-91

### 3000K

LED SMD 8,3W 1500lm

- 157C-L0109B-01
- 157C-L0109B-02
- ▒ 157C-L0109B-03
- ▒ 157C-L0109B-04
- 157C-L0109B-91

### 4000K

LED COB AC 8,3W 1595lm

- 157C-L0209B-01
- 157C-L0209B-02
- ▒ 157C-L0209B-03
- ▒ 157C-L0209B-04
- 157C-L0209B-91



- 157C-L30RDB-01
- 157C-L30RDB-02
- ▒ 157C-L30RDB-03
- ▒ 157C-L30RDB-04
- 157C-L30RDB-91

- 157C-L01RDB-01
- 157C-L01RDB-02
- ▒ 157C-L01RDB-03
- ▒ 157C-L01RDB-04
- 157C-L01RDB-91

- 157C-L02RDB-01
- 157C-L02RDB-02
- ▒ 157C-L02RDB-03
- ▒ 157C-L02RDB-04
- 157C-L02RDB-91



### 2700K

2x LED SMD 6W 950lm

- 157D-L30G6B-01
- 157D-L30G6B-02
- ▒ 157D-L30G6B-03
- ▒ 157D-L30G6B-04
- 157D-L30G6B-91

### 3000K

2x LED SMD 8,3W 1500lm

- 157D-L01G9B-01
- 157D-L01G9B-02
- ▒ 157D-L01G9B-03
- ▒ 157D-L01G9B-04
- 157D-L01G9B-91

### 4000K

2x LED COB AC 8,3W 1595lm

- 157D-L02G9B-01
- 157D-L02G9B-02
- ▒ 157D-L02G9B-03
- ▒ 157D-L02G9B-04
- 157D-L02G9B-91



- 157D-L30RDB-01
- 157D-L30RDB-02
- ▒ 157D-L30RDB-03
- ▒ 157D-L30RDB-04
- 157D-L30RDB-91

- 157D-L01RDB-01
- 157D-L01RDB-02
- ▒ 157D-L01RDB-03
- ▒ 157D-L01RDB-04
- 157D-L01RDB-91

- 157D-L02RDB-01
- 157D-L02RDB-02
- ▒ 157D-L02RDB-03
- ▒ 157D-L02RDB-04
- 157D-L02RDB-91



Acabado blanco, negro, gris, antracita o marrón cobrizo / White, black, grey, anthracite or copper brown finish



399E-

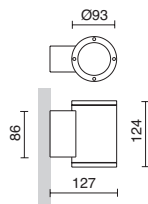

399B-

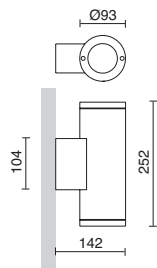

**3000K**  
LED SMD AC 4W 500lm

- 399E-L0105B-04
- 399E-L0105B-90

**4000K**  
LED SMD AC 4W 510lm

- 399E-L0205B-04
- 399E-L0205B-90



**2x LED SMD AC 4W 500lm**

- 399B-L0108B-04
- 399B-L0108B-90

**2x LED SMD AC 4W 510lm**

- 399B-L0208B-04
- 399B-L0208B-90



**GU10 LED 3.5W/4.5W - GU10 HAL 50W max.**

- 399E-G21X1A-04
- 399E-G21X1A-90



**2x GU10 LED 3.5W/4.5W - 2x GU10 HAL 50W max.**

- 399B-G21X1A-04
- 399B-G21X1A-90



Acabado antracita o marrón óxido / Anthracite or oxide brown finish

Lamps p. 792

# SETH

WALL LIGHTS



399C-



399D-

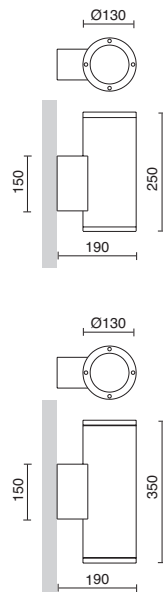

**3000K**

LED SMD AC 17,5W 2125lm

- 399C-LO118B-04
- 399C-LO118B-90

**4000K**

LED SMD AC 17,5W 2270lm

- 399C-LO218B-04
- 399C-LO218B-90



**2x LED SMD AC 17,5W 2125lm**

- 399C-LO1H3B-04
- 399C-LO1H3B-90

**2x LED SMD AC 17,5W 2270lm**

- 399C-LO2H3B-04
- 399C-LO2H3B-90



**E27 LED/HAL 75W max.**

- 399C-G05X1A-04
- 399C-G05X1A-90



**2x E27 LED/HAL 75W max.**

- 399D-G05X1A-04
- 399D-G05X1A-90



Acabado antracita o marrón óxido / Anthracite or oxide brown finish

Lamps p. 791



398A-

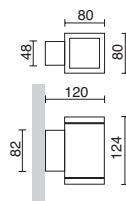

398B-

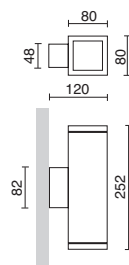

**3000K**  
LED SMD AC 4W 500lm

- 398A-L0105B-04
- 398A-L0105B-90

**4000K**  
LED SMD AC 4W 510lm

- 398A-L0205B-04
- 398A-L0205B-90



**2x LED SMD AC 4W 500lm**

- 398B-L01C4B-04
- 398B-L01C4B-90

**2x LED SMD AC 4W 510lm**

- 398B-L02C4B-04
- 398B-L02C4B-90



**GU10 LED 3.5W/4,5W - GU10 HAL 50W max.**

- 398A-G21X1A-04
- 398A-G21X1A-90



**2x GU10 LED 3.5W/4,5W - 2x GU10 HAL 50W max.**

- 398B-G21X1A-04
- 398B-G21X1A-90



Acabado antracita o marrón óxido / Anthracite or oxide brown finish

Lamps p. 792





398C-



398E-

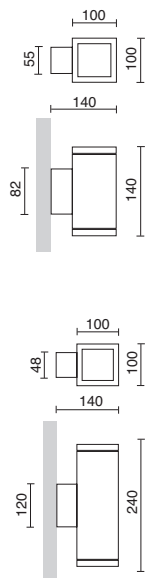

**3000K**

LED SMD AC 8,5W 1050lm

- 398C-L0109B-04
- 398C-L0109B-90

**4000K**

LED SMD AC 8,5W 1120lm

- 398C-L0209B-04
- 398C-L0209B-90



**2x** LED SMD AC 8,5W 1050lm

- 398C-L01G9B-04
- 398C-L01G9B-90

**2x** LED SMD AC 8,5W 1120lm

- 398C-L02G9B-04
- 398C-L02G9B-90



GU10 LED 3,5W/4,5W - GU10 HAL 50W max.

- 398C-G21X1A-04
- 398C-G21X1A-90



**2x** GU10 LED 3,5W/4,5W - **2x** GU10 HAL 50W max.

- 398E-G21X1A-04
- 398E-G21X1A-90



Acabado antracita o marrón óxido / Anthracite or oxide brown finish

Lamps p. 792



580A-



580B-

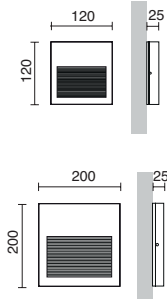

**3000K**

LED SMD 3W 367lm

- 580A-LO104B-03
- 580A-LO104B-04

**4000K**

LED SMD 3W 389lm

- 580A-LO204B-03
- 580A-LO204B-04



LED SMD 9W 1100lm

- 580B-LO110B-03
- 580B-LO110B-04

LED SMD 9W 1165lm

- 580B-LO210B-03
- 580B-LO210B-04



289B-



289C-

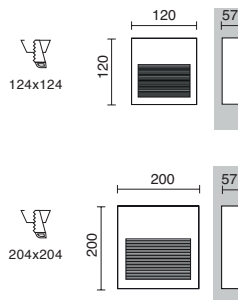

**3000K**

LED SMD 3W 367lm

- 289B-LO104B-03
- 289B-LO104B-04

**4000K**

LED SMD 3W 389lm

- 289B-LO204B-03
- 289B-LO204B-04



LED SMD 9W 1100lm

- 289C-LO110B-03
- 289C-LO110B-04

LED SMD 9W 1165lm

- 289C-LO210B-03
- 289C-LO210B-04



Acabado gris o antracita / Grey or anthracite finish



580C-



580D-

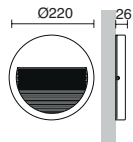
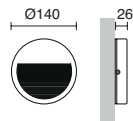

### 3000K

LED SMD 4W 544lm

- 580C-LO104B-03
- 580C-LO104B-04

### 4000K

LED SMD 4W 576lm

- 580C-LO204B-03
- 580C-LO204B-04



LED SMD 9W 1100lm

- 580D-LO110B-03
- 580D-LO110B-04

LED SMD 9W 1165lm

- 580D-LO210B-03
- 580D-LO210B-04



289D-



289E-

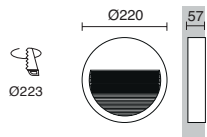
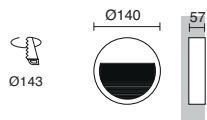

### 3000K

LED SMD 4W 544lm

- 289D-LO104B-03
- 289D-LO104B-04

### 4000K

LED SMD 4W 576lm

- 289D-LO204B-03
- 289D-LO204B-04



LED SMD 9W 1100lm

- 289E-LO110B-03
- 289E-LO110B-04

LED SMD 9W 1165lm

- 289E-LO210B-03
- 289E-LO210B-04



Acabado gris o antracita / Grey or anthracite finish



923B-



923A-

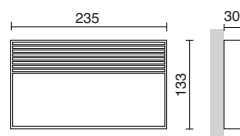
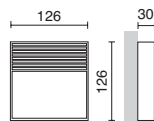

**3000K**  
LED SMD AC 5W 540lm

■ 923B-L3105B-04

LED SMD AC 13W 1410lm

■ 923A-L3113B-04

**4000K**  
LED SMD AC 5W 580lm

■ 923B-L3305B-04

LED SMD AC 13W 1510lm

■ 923A-L3313B-04



Acabado antracita / Anthracite finish

Consultar otras opciones de acabado  
Consult other finishing options



*Xalet del Nin, Vilanova i la Geltrú (Barcelona)*



261C-



261A-

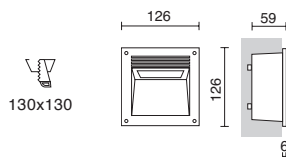

130x130

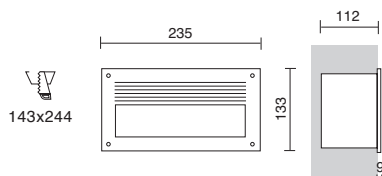

143x244

**3000K**  
LED SMD AC 4W 500lm

■ 261C-L0105B-04

LED SMD AC 13W 1710lm

■ 261A-L0109B-04

**4000K**  
LED SMD AC 4W 510lm

■ 261C-L0205B-04

LED SMD AC 13W 1790lm

■ 261A-L0209B-04



Acabado antracita / Anthracite finish

Consultar otras opciones de acabado  
Consult other finishing options

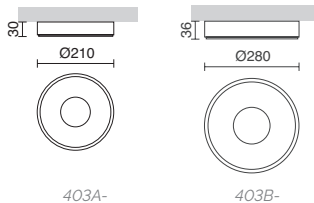

### Ø210

LED COB 12W 1800lm 3000K

403A-L0112B-01

### Ø280

LED COB 30W 3800lm 3000K

403B-L0130B-01

403B-L01RDB-01

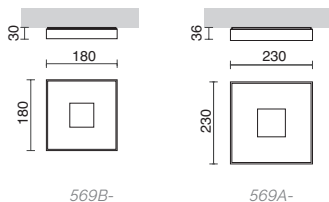

### L180

LED COB 12W 1700lm 3000K

569B-L0112B-01

### L230

LED COB 30W 3600lm 3000K

569A-L0130B-01

569A-L01RDB-01



Acabado blanco / White finish



Consultar 4000K  
Consult 4000K

Consultar otras opciones de acabado  
Consult other finishing options

Consultar opciones de regulación.  
Consult regulation options.

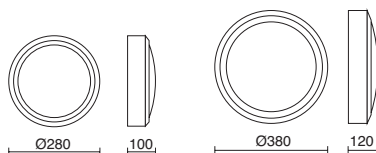

### Ø280

E27 Led/Hal/Fluo 42W max.

- 575B-G05X1A-01
- 575B-G05X1A-04

### Ø380

2x E27 Led/Hal/Fluo 42W max.

- 575A-G05X1A-01
- 575A-G05X1A-04



### Ø280

LED SMD AC 17,5W 1550lm 3000K

- 575B-L0118B-01
- 575B-L0118B-04

### Ø380

LED SMD AC 29W 3830lm 3000K

- 575A-L0129R-01
- 575A-L0129R-04



 **EMERGENCY (3h max.)**  
LED 3W 250lm 4000K

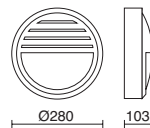

E27 Led/Hal/Fluo 42W max.

- 575C-G05X1A-01
- 575C-G05X1A-04



LED SMD AC 17,5W 1550lm 3000K

- 575C-L0118B-01
- 575C-L0118B-04



Acabado blanco o antracita / White or anthracite finish

Lamps p. 791

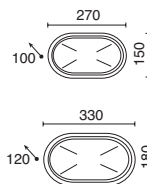

### L270

E27 Led/Hal/Fluo 42W max.

□ 240B-G05X1A-01

■ 240B-G05X1A-02

### L330

E27 Led/Hal/Fluo 42W max.

□ 240C-G05X1A-01

■ 240C-G05X1A-02

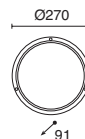

E27 Led/Hal/Fluo 42W max.

□ 240E-G05X1A-01

■ 240E-G05X1A-02

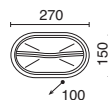

E27 Led/Hal/Fluo 42W max.

□ 240A-G05X1A-01

■ 240A-G05X1A-02

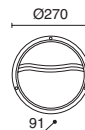

E27 Led/Hal/Fluo 42W max.

□ 240D-G05X1A-01

■ 240D-G05X1A-02







007A-

Ø250

E27 Led/Hal/Fluo 60W max.

□ 007A-G05X1A-01

■ 007A-G05X1A-02



007B-

Ø340

E27 Led/Hal/Fluo 60W max.

□ 007B-G05X1A-01

■ 007B-G05X1A-02

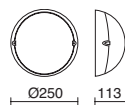

Ø250 113

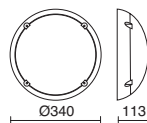

Ø340 113



Acabado blanco o negro / White or black finish

Lamps p. 791



O63A-



O63B-

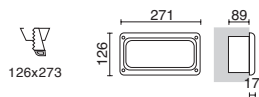

E27 Led/Hal/Fluo 42W max.

□ O63A-G05X1A-01

■ O63A-G05X1A-02

□ O63B-G05X1A-01

■ O63B-G05X1A-02



Acabado blanco o negro / White or black finish

Lamps p. 791

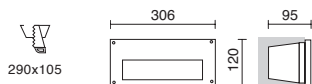

LED SMD AC 13W 1790lm 3000K

- 401A-L0113B-03
- 401A-L0113B-04



E27 Led/Hal/Fluo 42W max.

- 401A-G05X1A-03
- 401A-G05X1A-04

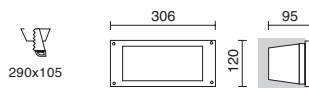

LED SMD AC 13W 1790lm 3000K

- 401B-L0113B-03
- 401B-L0113B-04



E27 Led/Hal/Fluo 42W max.

- 401B-G05X1A-03
- 401B-G05X1A-04

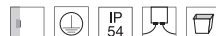

Acabado gris o antracita / Grey or anthracite finish

Lamps p. 791

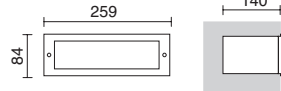

**3000K**  
LED COB 6W 816lm

**4000K**  
LED COB 6W 864lm

■ 018A-L0107B-30

■ 018A-L0207B-30



Acabado inox / Stainless steel finish

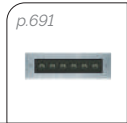

# SYNA

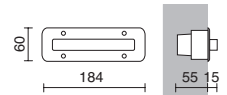
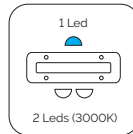
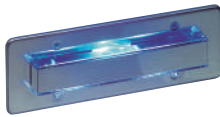

LED SMD 3W 3000K (☺) + Azul / Blue / Bleu (☹)

■ ● 305A-L9804H-30

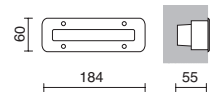

LED SMD 3W 300lm 3000K

■ ○ 305B-L0104H-30



**Alimentador / Power supply**  
max. 17W (max. 4 unit.)

B02A-X3317H-01

110V 240V AC	350mA DC	IP 20
IN		OUT



Acabado inox / Stainless steel finish

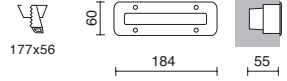

**3500K**  
LED SMD 1.3W 200lm

■ ○ 305C-L0102F-30

	<b>Alimentador / Power supply</b> 15W (max. 9 unit.)			
	BO2A-X33X2F-01	220V 240V AC	24V DC	IP 20
		IN	OUT	

	<b>Alimentador / Power supply</b> 12W (max. 7 unit.)			
	BO2Q-X3312F-01	90V 255V AC	24V DC	IP 30
		IN	OUT	



Acabado inox / Stainless steel finish





# Downlights







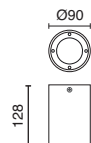

GU10 12W max.

- 965D-G21X1A-NB
- 965D-G21X1A-NN
- 965D-G21X1A-NR
- 965D-G21X1A-NW



Lamps p.792

Antracita / Anthracite

Natural / Natural

Rojo / Red

Blanco / White

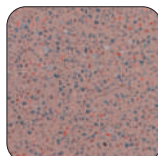

-NB

-NN

-NR

-NW

Conector IP67 incluido  
IP67 connector included



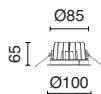

**3000K**  
LED COB 9W 1940lm

**4000K**  
LED COB 9W 2000lm

□ 1040A-L3109H30-01

□ 1040A-L3309H30-01



**Alimentador / Power supply**  
max. 17W 350mA DC

B02A-X3317H-01

220V 240V AC IP 20

ON DIP  
1 2 3 4

**Alimentador / Power supply**  
max. 26W 350mA DC

B02P-X3326HI-01

110V 240V AC IP 67

ON DIP  
1 2 3 4

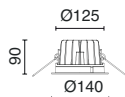

**3000K**  
LED COB 18W 2845lm

**4000K**  
LED COB 18W 2960lm

□ 1040B-L3118I50-01

□ 1040B-L3318I50-01



**Alimentador / Power supply**  
max. 20W 500mA DC

B02A-X3320I-01

220V 240V AC IP 20

ON DIP  
1 2 3 4

**Alimentador / Power supply**  
max. 26W 500mA DC

B02P-X3326HI-01

110V 240V AC IP 67

ON DIP  
1 2 3 4



Acabado blanco / White finish

ON DIP Corriente de salida ajustable  
1 2 3 4 Adjustable output current

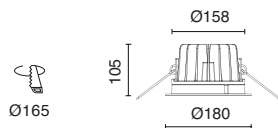

**3000K**

LED COB 24W 4115lm

□ 1040C-L3124J70-01

**4000K**

LED COB 24W 4266lm

□ 1040C-L3324J70-01



**Alimentador / Power supply**  
max. 30W 700mA DC

B02N-X3330J-01

220V  
240V  
AC

IP  
20

**Alimentador / Power supply**  
max. 40W 700mA DC

B02P-X3340JM-01

110V  
240V  
AC

IP  
67

ON DIP  
1 2 3 4

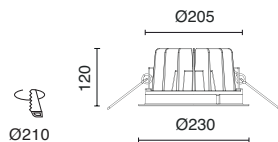

**3000K**

LED COB 37W 5925lm

□ 1040D-L3137M90-01

**4000K**

LED COB 37W 6155lm

□ 1040D-L3337M90-01



**Alimentador / Power supply**  
max. 40W 1050mA DC

B02N-X3340M-01

220V  
240V  
AC

IP  
20

ON DIP  
1 2 3 4

**Alimentador / Power supply**  
max. 40W 1050mA DC

B02P-X3340JM-01

110V  
240V  
AC

IP  
67

ON DIP  
1 2 3 4



Acabado blanco / White finish

ON DIP  
1 2 3 4 *Corriente de salida ajustable*  
*Adjustable output current*



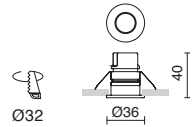

LED COB 3W 350lm 3000K

980A-L0103H-30



Disponibile en 30°, 45° o asimétrico  
Available in 45° or asymmetric



**Alimentador / Power supply**  
max. 12W 700mA DC



B02A-X3320I-01

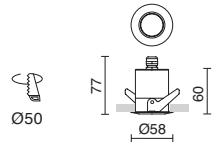

LED COB 4W 534lm 3000K

980B-L0104H-30



**Alimentador / Power supply**  
max. 12W 350mA DC



B02A-X3317H-01



LED COB 6,5W 785lm 3000K

980B-L0106H-30



Disponibile en 52°  
Available in 52°



**Alimentador / Power supply**  
max. 12W 700mA DC



B02A-X3320I-01



Acabado inox / Stainless steel finish

p.681



Regulable con dispositivos de control específicos (alimentadores p.794)  
Adjustable with specific control devices (power supplies p.794)



# Uplights

¿Cómo instalar un empotrable en el suelo?

Video



How to install a recessed floor?

Video







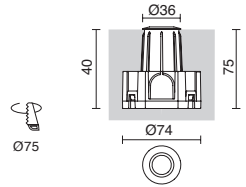

LED COB 3W 350lm 3000K

980H-L0103H-30

TERMO PLÁSTICO	14°	700mA DC	CR1 >90
----------------	-----	----------	---------

Disponibile en 45° o asimétrico  
Available in 45° or asymmetric

**Alimentador / Power supply**  
max. 12W 700mA DC

B02A-X3320I-01

220V 240V AC IP 20

ON 1 2 3 4 DIP

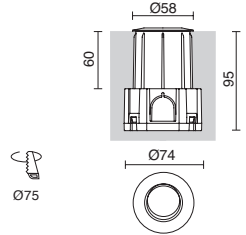

LED COB 4W 534lm 3000K

980I-L0104H-30

ALU	21°	350mA DC	CR1 >90
-----	-----	----------	---------

**Alimentador / Power supply**  
max. 12W 350mA DC

B02A-X3317H-01

110V 240V AC IP 20

ON 1 2 3 4 DIP

LED COB 6,5W 785lm 3000K

980I-L0106H-30

ALU	34°	700mA DC	CR1 >80
-----	-----	----------	---------

Disponibile en 52°  
Available in 52°

**Alimentador / Power supply**  
max. 12W 700mA DC

B02A-X3320I-01

220V 240V AC IP 20

ON 1 2 3 4 DIP

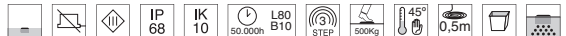

Acabado inox / Stainless steel finish

CONNECTORS p.793

Regulable con dispositivos de control específicos (alimentadores p.794)  
Adjustable with specific control devices (power supplies p.794)



Evite siempre colocar las luminarias en vaguadas o depresiones del terreno. Es indispensable realizar un drenaje.  
Always avoid placing the lights in valleys or depressions of the ground. It is essential to carry out an efficient drainage.





*Xalet del Nin, Vilanova i la Geltrú (Barcelona)*

# ESTAMBUL



INOX  
AISI  
316L

GU10 Led/Hal 35W max.

410A-G21X1A-30



BRASS

GU10 Led/Hal 35W max.

410A-G21X1A-34

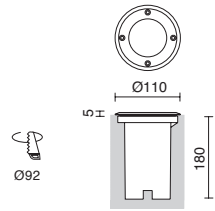

ALU GLASS TRANS



110V  
240V  
AC



IP  
67

IK  
08

2.000Kg  
25km/h

0,5m



SEA SIDE  
SUITABLE



Acabado inox o latón / Stainless steel or brass finish

Lamps p.792

Tornillos antihurto  
Anti-theft screws

Posición de portalámparas variable  
Adjustable lampholder position

CONNECTORS p.793

# FOCUS

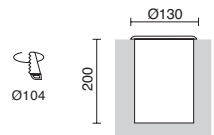

GU10 LED 3000K 5W (36°)

113A-L2105A-02

PA PA GLASS TRANS



110V  
240V  
AC



IP  
66

2000Kg



SEA SIDE  
SUITABLE



Acabado negro / Black finish

p.786



Evite siempre colocar las luminarias en vaguadas o depresiones del terreno. Es indispensable realizar un drenaje.  
Always avoid placing the lights in valleys or depressions of the ground. It is essential to carry out an efficient drainage.

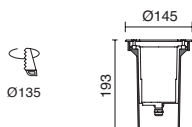

**3000K**  
LED COB 7W 860lm

**4000K**  
LED COB 7W 890lm

1023A-L3107B10-30

1023A-L3307B10-30

10°

1023A-L3107B20-30

1023A-L3307B20-30

26°

1023A-L3107B50-30

1023A-L3307B50-30

56°

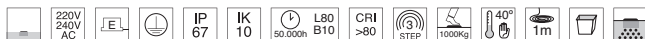

Acabado inox / Stainless steel finish

CONNECTORS p.793

Marco cuadrado disponible  
Square frame available



*Evite siempre colocar las luminarias en vaguadas o depresiones del terreno. Es indispensable realizar un drenaje.  
Always avoid placing the lights in valleys or depressions of the ground. It is essential to carry out an efficient drainage.*



1023B-



1023C-

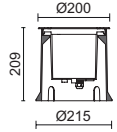

**3000K**

LED COB 16W 2170lm

1023B-L3116B10-30

1023B-L3116B30-30

1023B-L3116B40-30

LED COB 12W 1680lm

1023C-L3116B30-30

**4000K**

LED COB 16W 2300lm

1023B-L3316B10-30

1023B-L3316B30-30

1023B-L3316B40-30

LED COB 12W 1750lm

1023C-L3316B30-30



**3000K**

LED COB 16W 2170lm

1023B-L3116B1D-30

1023B-L3116B3D-30

1023B-L3116B4D-30

LED COB 12W 1680lm

1023C-L3116B3D-30

**4000K**

LED COB 16W 2300lm

1023B-L3316B1D-30

1023B-L3316B3D-30

1023B-L3316B4D-30

LED COB 12W 1750lm

1023C-L3316B3D-30

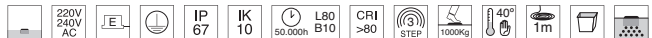

Acabado inox / Stainless steel finish

CONNECTORS p.793

Marco cuadrado disponible  
Square frame available



Evite siempre colocar las luminarias en vaguadas o depresiones del terreno. Es indispensable realizar un drenaje.  
Always avoid placing the lights in valleys or depressions of the ground. It is essential to carry out an efficient drainage.



1023D-



1023E-

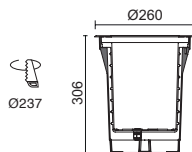

<b>3000K</b> LED COB 32W 4850lm	<b>4000K</b> LED COB 32W 5100lm	
1023D-L3125B10-30	1023D-L3325B10-30	14°
1023D-L3125B30-30	1023D-L3325B30-30	32°
1023D-L3125B40-30	1023D-L3325B40-30	44°
LED COB 26W 3540lm	LED COB 26W 3670lm	
1023E-L3125B30-30	1023E-L3325B30-30	35°

<b>3000K</b> LED COB 32W 4850lm	<b>4000K</b> LED COB 32W 5100lm	
1023D-L3125B1D-30	1023D-L3325B1D-30	14°
1023D-L3125B3D-30	1023D-L3325B3D-30	32°
1023D-L3125B4D-30	1023D-L3325B4D-30	44°
LED COB 26W 3540lm	LED COB 26W 3670lm	
1023E-L3125B3D-30	1023E-L3325B3D-30	35°

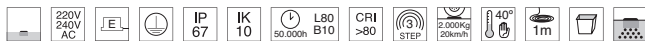

Acabado inox / Stainless steel finish

CONNECTORS p.793

Marco cuadrado disponible  
Square frame available

Consultar otras opciones de regulación  
Consult other regulation options



Evite siempre colocar las luminarias en vaguadas o depresiones del terreno. Es indispensable realizar un drenaje.  
Always avoid placing the lights in valleys or depressions of the ground. It is essential to carry out an efficient drainage.

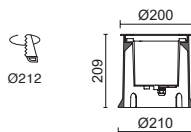
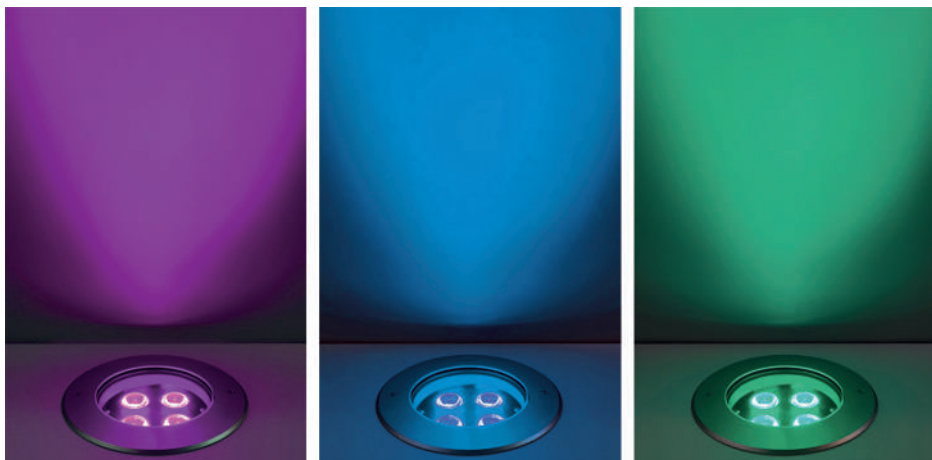

LED SMD 12W 1650lm

1023F-L1412F1X-30

10°

1023F-L1412F3X-30

30°

1023F-L1412F6X-30

60°



Acabado inox / Stainless steel finish

CONNECTORS p.793

Marco cuadrado disponible  
Square frame available

Consultar opciones de regulación  
Consult regulation options



Evite siempre colocar las luminarias en vaguadas o depresiones del terreno. Es indispensable realizar un drenaje.  
Always avoid placing the lights in valleys or depressions of the ground. It is essential to carry out an efficient drainage.





*Xalet del Nin, Vilanova i la Geltrú (Barcelona)*



# SOFIA

## UPLIGHTS



Ø177



LED COB **12W** 1800lm 3000K

LED COB **18W** 2500lm 3000K

■ 404A-L0112B-30

■ 404A-L0118B-30



Disponibile en 15° o 45°  
Available in 15° or 45°



Ø300

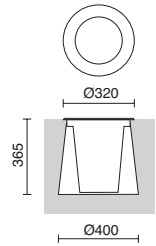

LED COB **18W** 2500lm 3000K

■ 404B-L0118B-30



Disponibile en 17° o 55°  
Available in 17° or 55°

LED COB **27W** 4100lm 3000K

■ 404B-L0127B-30



Disponibile en 40° o 60°  
Available in 40° or 60°



Acabado inox / Stainless steel finish



Led con reflector metalizado.  
Led metalized reflector.

Incorpora un cristal interno de 4mm.  
Incorporates internal glass lens of 4mm.

Óptica especular de alto rendimiento.  
Efficiency specular optics.

Consultar disponibilidad 4000K.  
Consult availability 4000K.

■ Caja de empotrar troncocónica. Instalación cementada.  
Truncated cone flush-mount box. Cemented installation.



Evite siempre colocar las luminarias en vaguadas o depresiones del terreno. Es indispensable realizar un drenaje.  
Always avoid placing the lights in valleys or depressions of the ground. It is essential to carry out an efficient drainage.



# NAT-LED

UPLIGHTS

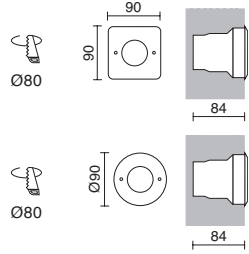

**3500K**  
LED SMD 1.5W 180lm

**Azul / Blue**  
LED SMD 1.5W

- 213A-L0102F-30
- 213B-L0102F-30

- 213A-L1002F-30
- 213B-L1002F-30



Acabado inox / Stainless steel finish  
Luz blanco o azul / White or blue light

**Alimentador / Power supply**  
15W (max. 8 unit.)

B02A-X33X2F-01

220V 240V AC	24V DC	IP 20
IN	OUT	

**Alimentador / Power supply**  
12W (max. 6 unit.)

B02Q-X3312F-01

90V 235V AC	24V DC	IP 30
IN	OUT	

# ARGIN

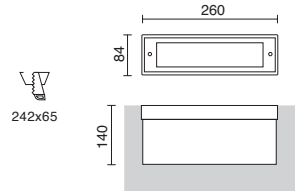

**3000K**  
LED SMD 10W 980lm

**4000K**  
LED SMD 10W 1090lm

- 191A-L0110B-30

- 191A-L0210B-30



Acabado inox / Stainless steel finish

CONNECTORS p.793

Consultar opciones de regulación  
Consult regulation options



Evite siempre colocar las luminarias en vaguadas o depresiones del terreno. Es indispensable realizar un drenaje.  
Always avoid placing the lights in valleys or depressions of the ground. It is essential to carry out an efficient drainage.







1070A-



1070B-



1070C-

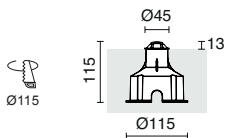

**2700K**

LED SMD 2W 170lm

■ 1070A-L3002FX0-04

■ 1070B-L3002FX0-04

■ 1070C-L3002FX0-04

**3000K**

LED SMD 2W 170lm

■ 1070A-L3102FX0-04

■ 1070B-L3102FX0-04

■ 1070C-L3102FX0-04

**4000K**

LED SMD 2W 190lm

■ 1070A-L3302FX0-04

■ 1070B-L3302FX0-04

■ 1070C-L3302FX0-04



1070D-

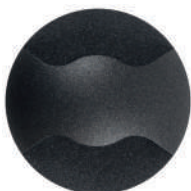

1070E-



1070F-

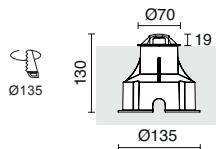

**2700K**

LED SMD 6W 690lm

■ 1070D-L3006FX0-04

■ 1070E-L3006FX0-04

■ 1070F-L3006FX0-04

**3000K**

LED SMD 6W 690lm

■ 1070D-L3106FX0-04

■ 1070E-L3106FX0-04

■ 1070F-L3106FX0-04

**4000K**

LED SMD 6W 750lm

■ 1070D-L3306FX0-04

■ 1070E-L3306FX0-04

■ 1070F-L3306FX0-04



Acabado antracita / Anthracite finish

Drivers p.794-795



Evite siempre colocar las luminarias en vaguadas o depresiones del terreno. Es indispensable realizar un drenaje.  
Always avoid placing the lights in valleys or depressions of the ground. It is essential to carry out an efficient drainage.





665B-



665E-



Ø46

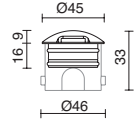

**3000K**

LED COB 1.5W 170lm

■ 665B-L0102F-43

■ 665E-L0102F-43

**4000K**

LED COB 1.5W 180lm

■ 665B-L0202F-43

■ 665E-L0202F-43



665C-



665F-



Ø56

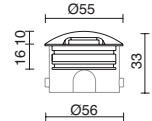

**3000K**

LED COB 2W 320lm

■ 665C-L0102F-43

■ 665F-L0102F-43

**4000K**

LED COB 2W 340lm

■ 665C-L0202F-43

■ 665F-L0202F-43

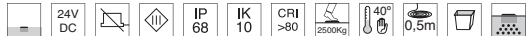

Acabado inox cepillado / Brushed stainless steel finish



CONNECTORS p.793

<b>Alimentador / Power supply</b>			
max. 12W (O>5)	max. 25W (O>11)		
B02Q-X3312F-01	B02Q-X3325F-01	110V 240V AC	24V DC
		50Hz 60Hz	IP 30



*Evite siempre colocar las luminarias en vaguadas o depresiones del terreno. Es indispensable realizar un drenaje. Always avoid placing the lights in valleys or depressions of the ground. It is essential to carry out an efficient drainage.*



302A-



302B-



302C-



Ø110

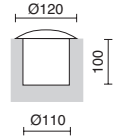

**3000K**

LED SMD AC 4W 500lm

■ 302A-L0105B-04

■ 302B-L0105B-04

■ 302C-L0105B-04

**4000K**

LED SMD AC 4W 510lm

■ 302A-L0205B-04

■ 302B-L0205B-04

■ 302C-L0205B-04



Acabado antracita / Anthracite finish

# SURI BIG



303A-



303B-



303C-



Ø186

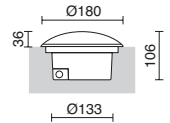

**3000K**

LED SMD 6W 800lm

■ 303A-L0106A-04

■ 303B-L0106A-04

■ 303C-L0106A-04

**4000K**

LED SMD 6W 800lm

■ 303A-L0206A-04

■ 303B-L0206A-04

■ 303C-L0206A-04



Acabado antracita / Anthracite finish



Evite siempre colocar las luminarias en vaguadas o depresiones del terreno. Es indispensable realizar un drenaje.  
Always avoid placing the lights in valleys or depressions of the ground. It is essential to carry out an efficient drainage.





Wall  
washers



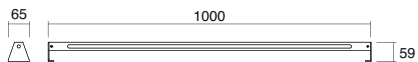
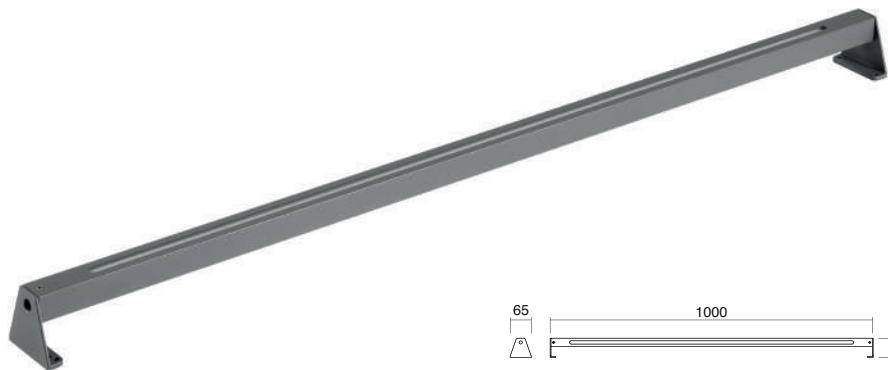

**3000K**  
LED SMD AC 15W 1500lm

**4000K**  
LED SMD AC 15W 1620lm

■ 1024C-L3115BX0-04

■ 1024C-L3315BX0-04

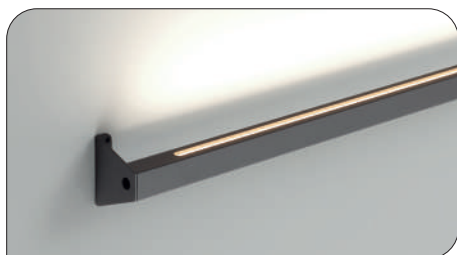

Conector IP67 incluido  
IP67 connector included



ALU (PC MAT)



Acabado antracita / Anthracite finish

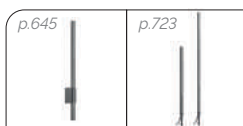

Video



**3000K**  
LED SMD 24W 2905lm

**4000K**  
LED SMD 24W 3050lm

■ 920A-L3122B-03

■ 920A-L3322B-03



■ 920B-L3122B-03

■ 920B-L3322B-03

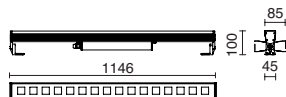

**3000K**  
LED SMD 51W 5810lm

**4000K**  
LED SMD 51W 6100lm

■ 920C-L3147B-03

■ 920C-L3347B-03



■ 920D-L3147B-03

■ 920D-L3347B-03



Acabado gris / Grey finish



CONNECTORS p.793

Otras ópticas disponibles (28°/50°)  
Other optics available (28°/50°)

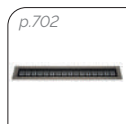

Video

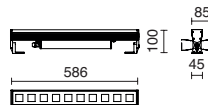

LED SMD **24W** 3300lm

920A-L1440F-03

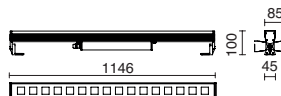

LED SMD **48W** 6600lm

920C-L1480F-03



Acabado gris / Grey finish

CONNECTORS p.793



Kit Controlador y mando a distancia para RGB/RGBW  
Controller and remote control kit for RGB/RGBW

CONT.R9+XC

**Controller**

Control: RF 2.4Ghz  
Exit sign: DMX512  
Input Voltage: 5-24Vdc  
10 statics colors  
32 dynamics modes

**Telecomando**

Control: 1 zone (30m)  
power supply: 1xCR2032 non inclue (3Vdc)  
Exit sign: RF 2.4Ghz

Sistema control DMX integrado.  
Integrated DMX control system.

Led Driver 24V DC remotos a consultar.  
Remote Led Driver 24V DC under request.

Otras ópticas disponibles (35°/54°/40°x20°)  
Other optics available (35°/54°/40°x20°)

p.703



Video



920G-  
920H-



920M- / 920N-  
920O- / 920P-

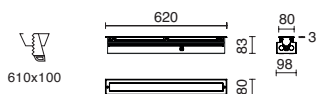

**3000K**  
LED SMD 12W 1740lm

■ 920G-L3112B-30

**4000K**  
LED SMD 12W 1840lm

■ 920G-L3312B-30



LED SMD 24W 2905lm

■ 920M-L3122B-30

LED SMD 24W 3050lm

■ 920M-L3322B-30



■ 920N-L3122B-30

■ 920N-L3322B-30

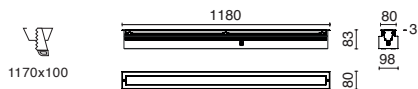

**3000K**  
LED SMD 24W 3480lm

■ 920H-L3124B-30

**4000K**  
LED SMD 24W 3680lm

■ 920H-L3324B-30



LED SMD 51W 5810lm

■ 920O-L3147B-30

LED SMD 51W 6100lm

■ 920O-L3347B-30



■ 920P-L3147B-30

■ 920P-L3347B-30



Acabado inox / Stainless steel finish

CONNECTORS p.793



*Evite siempre colocar las luminarias en vaguadas o depresiones del terreno. Es indispensable realizar un drenaje.  
Always avoid placing the lights in valleys or depressions of the ground. It is essential to carry out an efficient drainage.*

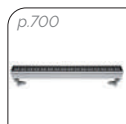

Video

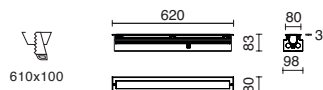
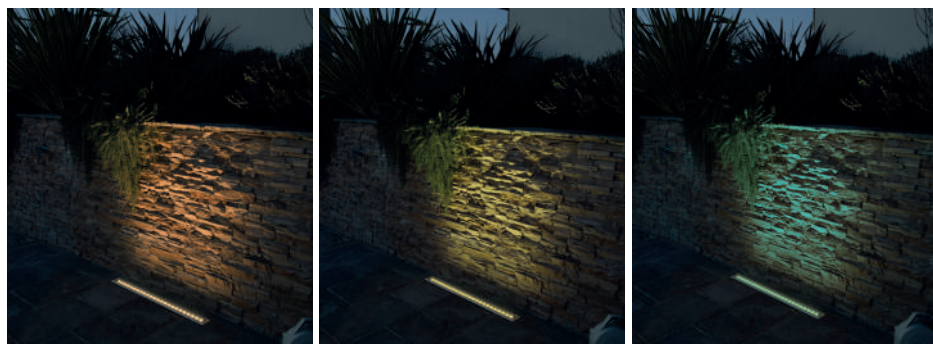

LED SMD **24W** 3300lm

920M-L1440F-30

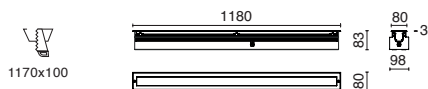

LED SMD **48W** 6600lm

9200-L1480F-30



Acabado inox / Stainless steel finish

CONNECTORS p.793



Kit Controlador y mando a distancia para RGB/RGBW  
Controller and remote control kit for RGB/RGBW

---

<p><b>CONT.R9+XC</b></p>	<p><b>Controller</b> Control: RF 2.4Ghz Exit sign: DMX512 Input Voltage: 5-24Vdc 10 statics colors 32 dynamics modes</p>	<p><b>Telecomando</b> Control: 1 zone (30m) power supply: 1xCR2032 non inclue (3Vdc) Exit sign: RF 2.4Ghz</p>
--------------------------	--	---



Sistema control DMX integrado.  
Integrated DMX control system.

Led Driver 24V DC remotos a consultar.  
Remote Led Driver 24V DC under request.

p.701



Evite siempre colocar las luminarias en vaguadas o depresiones del terreno. Es indispensable realizar un drenaje.  
Always avoid placing the lights in valleys or depressions of the ground. It is essential to carry out an efficient drainage.





Solar

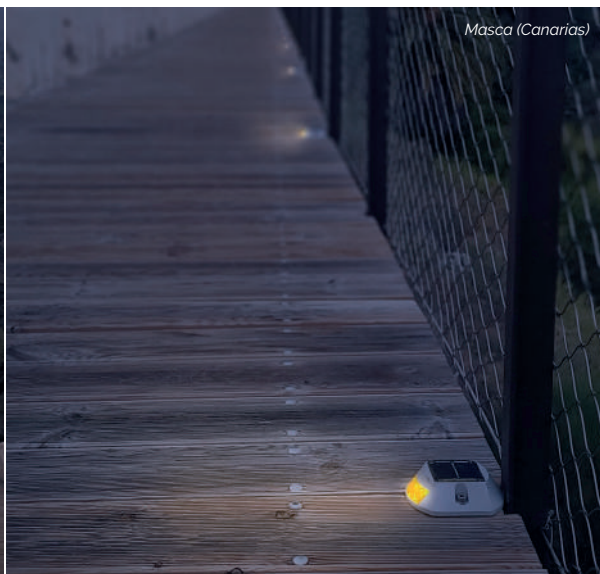
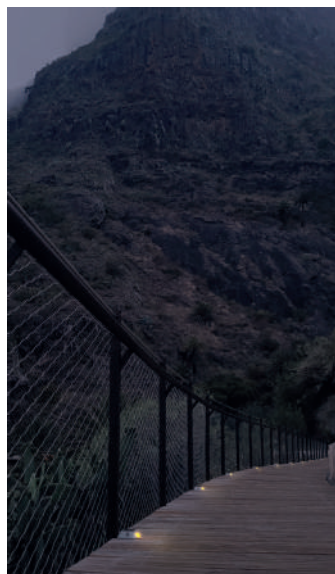

Masca (Canarias)

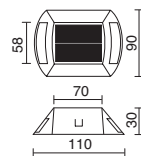

Intermitente / Flashing

- 152A-L02X1K-03
- 152A-L07X1K-03

- 152C-L02X1K-03
- 152C-L07X1K-03

Fijo / Steady

- 152B-L02X1K-03
- 152B-L07X1K-03

- 152D-L02X1K-03
- 152D-L07X1K-03

3 LED

3\*3 LED



Acabado gris / Grey finish

Luz blanco o naranja / White or orange light

Tiempo de carga: 3/8h  
 Duración carga completa: 16h  
 Nivel sensor: 150/350 lux

Loading time: 3/8h  
 Full load duration: 16h  
 Sensor level: 150/350 lux

Consultar otros colores disponibles / Check other available colors

# MITRA

SOLAR



Tiempo de carga: 3/8h  
 Duración carga completa: 16h  
 Nivel sensor: 150/350 lux  
 Loading time: 3/8h  
 Full load duration: 16h  
 Sensor level: 150/350 lux

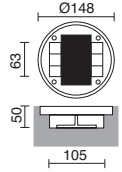

Intermitente / Flashing

Fijo / Steady

- 208A-L02X1K-03
- 208A-L07X1K-03

- 208B-L02X1K-03
- 208B-L07X1K-03



Intermitente / Flashing / Intermittent

Fijo / Steady / Permanent

- 208C-L02X1K-03
- 208C-L07X1K-03

- 208D-L02X1K-03
- 208D-L07X1K-03

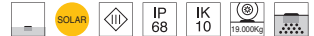

Acabado gris / Grey finish  
 Luz blanco o naranja / White or orange light

Duración carga completa: 16h / Full load duration: 16h

# UTU MINI

# UTU ROUND



338A-



339A-



105x105



Ø110

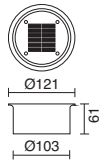
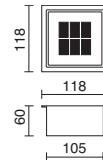

Fijo / Steady / Permanent

- 338A-L02X1K-29
- 338A-L07X1K-29

- 339A-L02X1K-29
- 339A-L07X1K-29



Acabado transparente / Transparent finish  
 Luz blanco o naranja / White or orange light

Duración carga completa: 18h / Full load duration: 18h

Tiempo de carga: 3/8h  
 Nivel sensor: 150/350 lux  
 Amplitud térmica: -25° +60 °C

Loading time: 3/8h  
 Sensor level: 150/350 lux  
 Thermal amplitude: -25° +60 °C

Consultar otros colores disponibles / Check other available colors



Evite siempre colocar las luminarias en vaguadas o depresiones del terreno. Es indispensable realizar un drenaje.  
 Always avoid placing the lights in valleys or depressions of the ground. It is essential to carry out an efficient drainage.



# Spotlights





**2700K**  
LED COB 5W 460lm

■ 1052A-L3806BV0-04

**3000K**  
LED COB 5W 485lm

■ 1052A-L3906BV0-04

**4000K**  
LED COB 5W 505lm

■ 1052A-L4006BV0-04

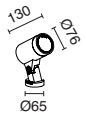

**2700K**  
LED COB 10,5W 1140lm

■ 1052B-L3812BV0-04

**3000K**  
LED COB 10,5W 1240lm

■ 1052B-L3912BV0-04

**4000K**  
LED COB 10,5W 1260lm

■ 1052B-L4012BV0-04

IK 07



**2700K**  
LED COB 24,5W 2580lm

■ 1052C-L3828BV0-04

**3000K**  
LED COB 24,5W 3035lm

■ 1052C-L3928BV0-04

**4000K**  
LED COB 24,5W 3160lm

■ 1052C-L4028BV0-04

IK 08



Acabado antracita / Anthracite finish



CONNECTORS p.793

For 1052A



For 1052B/1052C

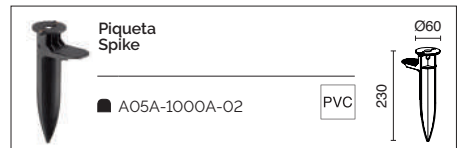





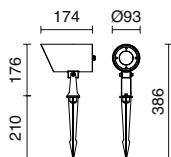

GU10 12W max.

■ 965H-G21X1A-NB

■ 965H-G21X1A-NN



Lamps p.792

Antracita / Anthracite

Natural / Natural



-NB



-NN

Conector IP67 incluido  
IP67 connector included



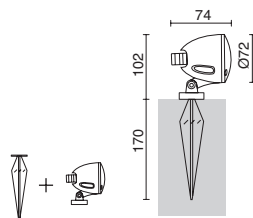

**3000K**  
LED COB 4W 534lm

■ 025C-L3106B10-02

■ 025C-L3106B30-02

**4000K**  
LED COB 4W 561lm

■ 025C-L3306B10-02

■ 025C-L3306B30-02

14°

36°



Acabado negro / Black finish

CONNECTORS p.793

Consultar opciones de regulación  
Consult regulation options

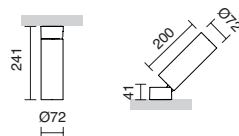

**3000K**  
LED COB 30W 3500lm

- 930A-L3130B-02
- 930A-L3130B-03

**4000K**  
LED COB 30W 3590lm

- 930A-L3330B-02
- 930A-L3330B-03



Acabado negro o gris / Black or grey finish

 CONNECTORS p.793

Disponibile en 42°  
Available in 42°



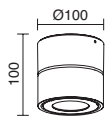

2700K LED COB <b>9W</b> 1098lm	3000K LED COB <b>9W</b> 1155lm	4000K LED COB <b>9W</b> 1200lm	
□ 1000A-L3009B10-01 ■ 1000A-L3009B10-04	□ 1000A-L3109B10-01 ■ 1000A-L3109B10-04	□ 1000A-L3309B10-01 ■ 1000A-L3309B10-04	▲ 14°
□ 1000A-L3009B30-01 ■ 1000A-L3009B30-04	□ 1000A-L3109B30-01 ■ 1000A-L3109B30-04	□ 1000A-L3309B30-01 ■ 1000A-L3309B30-04	▲ 34°
□ 1000A-L3009B50-01 ■ 1000A-L3009B50-04	□ 1000A-L3109B50-01 ■ 1000A-L3109B50-04	□ 1000A-L3309B50-01 ■ 1000A-L3309B50-04	▲ 49°

2700K LED COB <b>13W</b> 1405lm	3000K LED COB <b>13W</b> 1480lm	4000K LED COB <b>13W</b> 1540lm	
□ 1000A-L3013B10-01 ■ 1000A-L3013B10-04	□ 1000A-L3113B10-01 ■ 1000A-L3113B10-04	□ 1000A-L3313B10-01 ■ 1000A-L3313B10-04	▲ 14°
□ 1000A-L3013B30-01 ■ 1000A-L3013B30-04	□ 1000A-L3113B30-01 ■ 1000A-L3113B30-04	□ 1000A-L3313B30-01 ■ 1000A-L3313B30-04	▲ 34°
□ 1000A-L3013B50-01 ■ 1000A-L3013B50-04	□ 1000A-L3113B50-01 ■ 1000A-L3113B50-04	□ 1000A-L3313B50-01 ■ 1000A-L3313B50-04	▲ 49°



Acabado blanco o gris / White or grey finish

Consultar opciones de regulación  
Consult regulation options

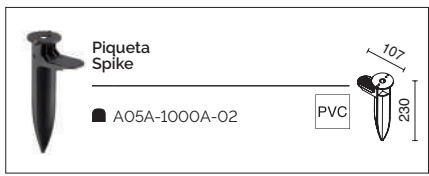





*Xalet del Nin, Vilanova i la Geltrú (Barcelona)*

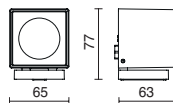

**3000K**  
LED COB AC 7W 680lm

**4000K**  
LED COB AC 7W 700lm

■ 922A-L3108B-04

■ 922A-L3308B-04



■ 922B-L3108B-04

■ 922B-L3308B-04



Acabado antracita / Anthracite finish

 CONNECTORS p.793

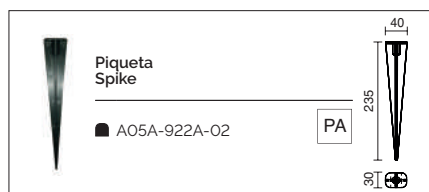

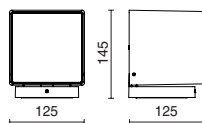

**3000K**  
LED COB 12W 1586lm

**4000K**  
LED COB AC 12W 1650lm

■ 922C-L3114B-04

■ 922C-L3314B-04

19°

**N** ■ 922C-L31RDB-04

**N** ■ 922C-L33RDB-04



19°

■ 922D-L3114B-04

■ 922D-L3314B-04

49°

**N** ■ 922D-L31RDB-04

**N** ■ 922D-L33RDB-04



49°



Acabado antracita / Anthracite finish

Consultar opciones de regulación  
Consult regulation options

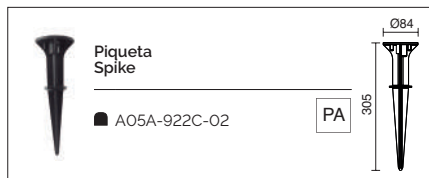





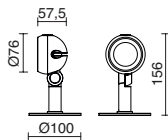

**3000K**  
LED 6W 680lm

**4000K**  
LED 6W 680lm

■ 998A-L3106E-02

■ 998A-L3306E-02



LED 10W 1200lm

LED 10W 1200lm

■ 998B-L3110E-02

■ 998B-L3310E-02

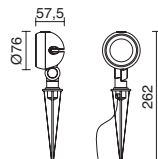

**3000K**  
LED 6W 680lm

**4000K**  
LED 6W 680lm

■ 998C-L3106E-02

■ 998C-L3306E-02



LED 10W 1200lm

LED 10W 1200lm

■ 998D-L3110E-02

■ 998D-L3310E-02



Acabado negro / Black finish

Conector IP67 incluido  
IP67 connector included

Alimentador / Power supply	
max. 30W	max. 75W
B02E-X3330E-00	B02E-X3375E-00
220V 240V AC	12V DC 50Hz 60Hz IP 65





## h800

LED SMD AC 12W 1150lm **3000K**

■ 1024A-L3112BXO-04

LED SMD AC 12W 1280lm **4000K**

■ 1024A-L3312BXO-04

## h1200

LED SMD AC 18W 1800lm **3000K**

■ 1024A-L3118BXO-04

LED SMD AC 18W 2000lm **4000K**

■ 1024A-L3318BXO-04



Acabado antracita / Anthracite finish

Conector IP67 incluido  
IP67 connector included

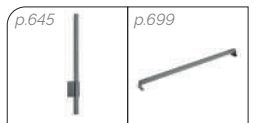

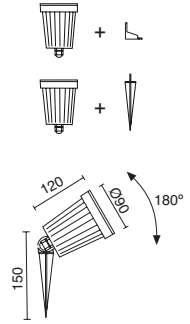

GU10 LED 5W 3000K 345lm (36°)

- 319A-L2105A-02
- 319A-L2105A-03



Acabado negro o gris / Black or grey finish

# ABBI

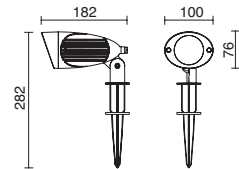

GU10 Led/Hal 50W max.

- 485A-G21X1A-04



Acabado antracita / Anthracite finish

Lamps p.792

 CONNECTORS p.793

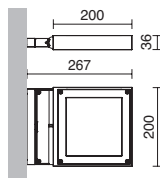

**3000K**

LED SMD 26W 2830lm

■ 928A-L3126B-04

■ 928B-L3126B-04

■ 928C-L3126B-04

**4000K**

LED SMD 26W 3340lm

■ 928A-L3326B-04

■ 928B-L3326B-04

■ 928C-L3326B-04



Poste no incluido / Post not included

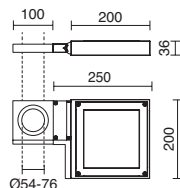

**3000K**

LED SMD 26W 2830lm

■ 928D-L3126B-04

■ 928E-L3126B-04

■ 928F-L3126B-04

**4000K**

LED SMD 26W 3340lm

■ 928D-L3326B-04

■ 928E-L3326B-04

■ 928F-L3326B-04



Acabado antracita / Anthracite finish





*Xalet del Nin, Vilanova i la Geltrú (Barcelona)*

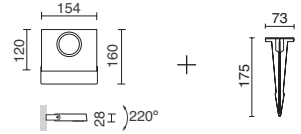

**12W**  
LED COB 1800lm 3000K

■ 402A-L0112B-02

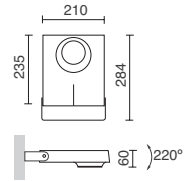

**39W**  
LED COB 4900lm 3000K

■ 402B-L0139B-02

**51W**  
LED COB 6400lm 3000K

■ 402C-L0151B-02



Acabado negro / Black finish

CONNECTORS p.793

Disponibile con ottiche differenti: 17°/55°/70°  
Available in different optics: 17°/55°/70°

Consultar 4000K.  
Consult 4000K.





# Bollards

*¿Cómo instalar una baliza?*

Video



*How to install a bollard?*

Video



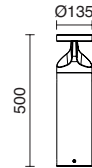

**2200K**  
LED SMD 21W 2500lm

■ 1051A-L2925ABO-02

■ 1051A-L2925ABD-02

■ 1051A-L2925ABG-02

**2700K**  
LED SMD 21W 2900lm

■ 1051A-L3025ABO-02

■ 1051A-L3025ABD-02

■ 1051A-L3025ABG-02



**3000K**  
LED SMD 21W 3100lm

■ 1051A-L3125ABO-02

■ 1051A-L3125ABD-02

■ 1051A-L3125ABG-02

**4000K**  
LED SMD 21W 3100lm

■ 1051A-L3325ABO-02

■ 1051A-L3325ABD-02

■ 1051A-L3325ABG-02



Acabado negro / Black finish

Conector IP67 incluido  
IP67 connector included



Instalar sobre suelo rígido. En césped o tierra, añadir pilastro de cemento.  
Install on rigid ground. On grass or earth, add pilaster cement.

Con tornillos antirrobo  
With anti-theft screws



**2200K**  
LED SMD 21W 2500lm

■ 1051B-L2925AB0-02

■ 1051B-L2925ABD-02

■ 1051B-L2925ABG-02

**2700K**  
LED SMD 21W 2900lm

■ 1051B-L3025AB0-02

■ 1051B-L3025ABD-02

■ 1051B-L3025ABG-02



**3000K**  
LED SMD 21W 3100lm

■ 1051B-L3125AB0-02

■ 1051B-L3125ABD-02

■ 1051B-L3125ABG-02

**4000K**  
LED SMD 21W 3100lm

■ 1051B-L3325AB0-02

■ 1051B-L3325ABD-02

■ 1051B-L3325ABG-02



Acabado negro / Black finish

Conector IP67 incluido  
IP67 connector included

 Instalar sobre suelo rígido. En césped o tierra, añadir pilastera de cemento.  
Install on rigid ground. On grass or earth, add pilaster cement.

Con tornillos antirrobo  
With anti-theft screws



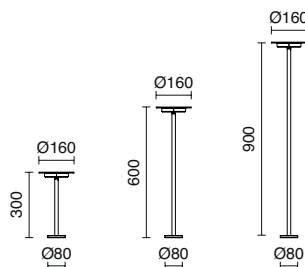

### 2700K

LED SMD 11W 1420lm

■ 1069B-L3011FCO-04

■ 1069C-L3011FCO-04

■ 1069D-L3011FCO-04

### 3000K

LED SMD 11W 1420lm

■ 1069B-L3111FCO-04

■ 1069C-L3111FCO-04

■ 1069D-L3111FCO-04

### 4000K

LED SMD 11W 1510lm

■ 1069B-L3311FCO-04

■ 1069C-L3311FCO-04

■ 1069D-L3311FCO-04



Acabado antracita / Anthracite finish

Drivers p.794-795

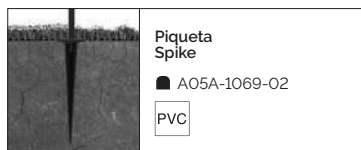

 Instalar sobre suelo rígido. En césped o tierra, añadir pilastro de cemento.  
Install on rigid ground. On grass or earth, add pilaster cement.





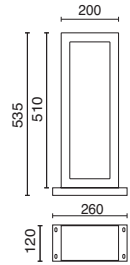

LED SMD 6W 400lm 3000K

- 965F-L3106B-NB
- 965F-L3106B-NN



--	--	--	--	--	--	--	--	--	--	--	--

Conector IP67 incluido  
IP67 connector included

Antracita / Anthracite

Natural / Natural



-NB



-NN

<p>p.643</p>	<p>p.644</p>
<p>p.673</p>	<p>p.713</p>

Instalar sobre suelo rígido. En césped o tierra, añadir pilaster de cemento.  
Install on rigid ground. On grass or earth, add pilaster cement.







## h250

LED SMD 8,5W 1500lm 3000K

- 926A-L3109B-80
- 926A-L3109B-81
- 926A-L3109B-82
- 926A-L3109B-83

## h600

LED SMD 8,5W 1500lm 3000K

- 926B-L3109B-80
- 926B-L3109B-81
- 926B-L3109B-82
- 926B-L3109B-83

## h1000

LED SMD 8,5W 1500lm 3000K

- 926C-L3109B-80
- 926C-L3109B-81
- 926C-L3109B-82
- 926C-L3109B-83



Acabado antracita / Anthracite finish

Neolight Nero Zimbabwe

Neolight Phedra Satin

Neolight Iron Moss Satin

Neolight La Bohème NH



-80



-81



-82



-83



p.641



 Instalar sobre suelo rígido. En césped o tierra, añadir pilastro de cemento.  
Install on rigid ground. On grass or earth, add pilaster cement.





929C-



929D-

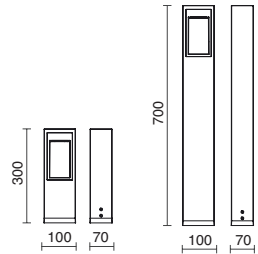

### h300

LED SMD 4,5W 500lm 3000K

- 929C-L3105B-02
- 929C-L3105B-03
- 929C-L3105B-90

### h700

LED SMD 4,5W 500lm 3000K

- 929D-L3105B-02
- 929D-L3105B-03
- 929D-L3105B-90

### Reflector decorativo opcional / Optional decorative reflector

- A13B-929-01
- A13B-929-02
- A13B-929-03
- A13B-929-47
- A13B-929-90



Acabado blanco, negro, gris o marrón óxido / White, black, grey or oxide brown finish

Disponible en 91°  
Available in 91°

Blanco / White

Negro / Black

Gris / Grey

Oro / Gold

Marrón óxido  
Oxide brown



-01



-02



-03



-47



-90

p.646



Instalar sobre suelo rígido. En césped o tierra, añadir pilastera de cemento.  
Install on rigid ground. On grass or earth, add pilaster cement.



# TURRET

BOLLARDS

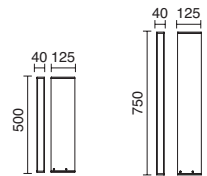

**3000K**  
LED SMD 10W 1300lm

■ 1018A-L3109AAO-04

LED SMD 13W 1750lm

■ 1018B-L3112AAO-04

**4000K**  
LED SMD 10W 1400lm

■ 1018A-L3309AAO-04

LED SMD 13W 1850lm

■ 1018B-L3312AAO-04



Acabado antracita / Anthracite finish



Conector IP67 incluido  
IP67 connector included



Instalar sobre suelo rígido. En césped o tierra, añadir pilastro de cemento.  
Install on rigid ground. On grass or earth, add pilaster cement.



932C-



932D-



932A-



**3000K**

LED SMD 12W 1760lm

- 932C-L3114B-02
- 932C-L3114B-90

- 932C-L31RDB-02
- 932C-L31RDB-90

**4000K**

LED SMD 12W 1840lm

- 932C-L3314B-02
- 932C-L3314B-90

- 932C-L33RDB-02
- 932C-L33RDB-90

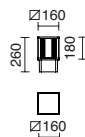

**3000K**

LED SMD 23W 3480lm

- 932D-L3125B-02
- 932D-L3125B-90

- 932D-L31RDB-02
- 932D-L31RDB-90

**4000K**

LED SMD 23W 3680lm

- 932D-L3325B-02
- 932D-L3325B-90

- 932D-L33RDB-02
- 932D-L33RDB-90

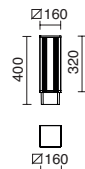

**3000K**

LED SMD 34W 5000lm

- 932A-L3133B-02
- 932A-L3133B-90

- 932A-L31RDB-02
- 932A-L31RDB-90

**4000K**

LED SMD 34W 5240lm

- 932A-L3333B-02
- 932A-L3333B-90

- 932A-L33RDB-02
- 932A-L33RDB-90

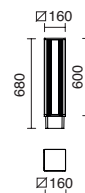

Acabado negro o marrón óxido / Black or oxide brown finish

Consultar opciones de regulación  
Consult regulation options

 Instalar sobre suelo rígido. En césped o tierra, añadir pilastro de cemento.  
Install on rigid ground. On grass or earth, add pilaster cement.

Video

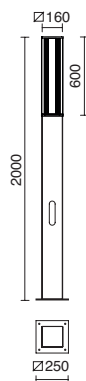

### 3000K

LED SMD 34W 5000lm

- 932B-L3133B-02
- 932B-L3133B-90

### 4000K

LED SMD 34W 5240lm

- 932B-L3333B-02
- 932B-L3333B-90

- N** ■ 932B-L31RDB-02
- N** ■ 932B-L31RDB-90

- N** ■ 932B-L33RDB-02
- N** ■ 932B-L33RDB-90

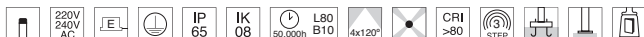

Acabado negro o marrón óxido / Black or oxide brown finish

Consultar opciones de regulación  
Consult regulation options



Instalar sobre suelo rígido. En césped o tierra, añadir pilastra de cemento.  
Install on rigid ground. On grass or earth, add pilaster cement.





2700K

LED SMD 24W 3870lm

**N** ■ 388A-L3020B-04

**N** ■ 388A-L30RDB-04

3000K

LED SMD 24W 3964lm

■ 388A-L3120B-04

**N** ■ 388A-L31RDB-04

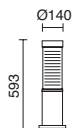

2700K

LED SMD 24W 3870lm

**N** ■ 388B-L3020B-04

**N** ■ 388B-L30RDB-04

3000K

LED SMD 24W 3964lm

■ 388B-L3120B-04

**N** ■ 388B-L31RDB-04

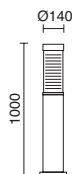

Acabado antracita / Anthracite finish

Disponible en 4000K / Available in 4000K

Disponible con difusor opal.  
Available with opal diffuser.



Instalar sobre suelo rígido. En césped o tierra, añadir pilastra de cemento.  
Install on rigid ground. On grass or earth, add pilaster cement.



# MAXIMA

## BOLLARDS



**2700K**  
LED SMD 42W 6193lm

**N** ■ 388C-L3036B-04

**N** ■ 388C-L30RDB-04

**3000K**  
LED SMD 42W 6342lm

■ 388C-L3136B-04

**N** ■ 388C-L31RDB-04

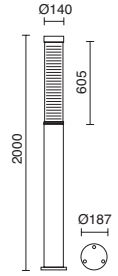

**2700K**  
LED SMD 42W 6193lm

**N** ■ 388D-L3036B-04

**N** ■ 388D-L30RDB-04

**3000K**  
LED SMD 42W 6342lm

■ 388D-L3136B-04

**N** ■ 388D-L31RDB-04

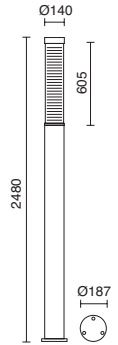

**2700K**  
LED SMD 42W 6193lm

**N** ■ 388E-L3036B-04

**N** ■ 388E-L30RDB-04

**3000K**  
LED SMD 42W 6342lm

■ 388E-L3136B-04

**N** ■ 388E-L31RDB-04

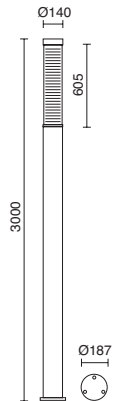

Acabado antracita / Anthracite finish

Disponible en 4000K / Available in 4000K



Versión con puerta de registro. Consulte disponibilidad.  
Available with inspection door. Please ask availability.

Disponible con difusor opal.  
Available with opal diffuser.



Instalar sobre suelo rígido. En césped o tierra, añadir pilastra de cemento.  
Install on rigid ground. On grass or earth, add pilaster cement.

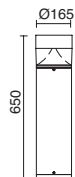

LED SMD 7W 960lm 3000K

■ 554A-L0108A-04

■ 554A-L01RDB-04



Acabado antracita / Anthracite finish

# MINI NICO



201A-



201B-

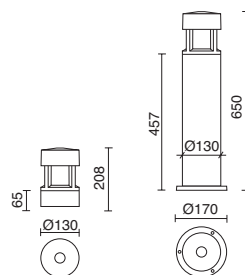

**h208**

E27 Led/Hal/Fluo 70W max.

■ 201A-G05X1A-03

■ 201A-G05X1A-04

■ 201A-G05X1A-90

**h650**

E27 Led/Hal/Fluo 70W max.

■ 201B-G05X1A-03

■ 201B-G05X1A-04

■ 201B-G05X1A-90



Acabado gris, antracita o marrón óxido / Grey, anthracite or oxide brown finish

Lamps p.791



Instalar sobre suelo rígido. En césped o tierra, añadir pilastra de cemento.  
Install on rigid ground. On grass or earth, add pilaster cement.



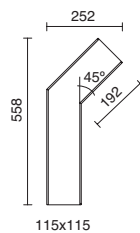

**2700K**  
LED COB AC 10W 830lm

- 492A-L3805B-02
- 492A-L3805B-90

**3000K**  
LED COB AC 10W 900lm

- 492A-L0105B-02
- 492A-L0105B-90

**4000K**  
LED COB AC 10W 940lm

- 492A-L0205B-02
- 492A-L0205B-90



Acabado negro o marrón óxido / Black or oxide brown finish



Instalar sobre suelo rígido. En césped o tierra, añadir pilastro de cemento.  
Install on rigid ground. On grass or earth, add pilaster cement.



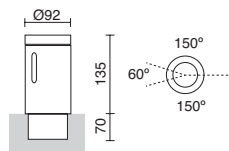

E27 Fluo 20W max.

■ 184A-G05X1A-60



Acabado Piedra Leccese / Leccese stone finish

Lamps p.791



Instalar sobre suelo rígido. En césped o tierra, añadir pilastera de cemento.  
Install on rigid ground. On grass or earth, add pilaster cement.



222B-



222C-

**3000K**

LED SMD AC 15W 2300lm

■ 222B-L3115B-02

**4000K**

LED SMD AC 15W 2300lm

■ 222B-L3315B-02

220V  
240V  
AC

E27 Led/Hal/Fluo 70W max.

■ 222B-G05X1A-02

110V  
240V  
AC

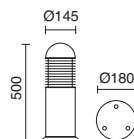

**3000K**

LED SMD AC 15W 2300lm

■ 222C-L3115B-02

**4000K**

LED SMD AC 15W 2300lm

■ 222C-L3315B-02

220V  
240V  
AC

E27 Led/Hal/Fluo 70W max.

■ 222C-G05X1A-02

110V  
240V  
AC

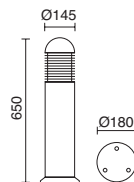

Acabado negro / Black finish

Lamps p.791



Instalar sobre suelo rígido. En césped o tierra, añadir pilastra de cemento.  
Install on rigid ground. On grass or earth, add pilaster cement.

Consultar otras opciones de acabado.  
Consult other finishing options.

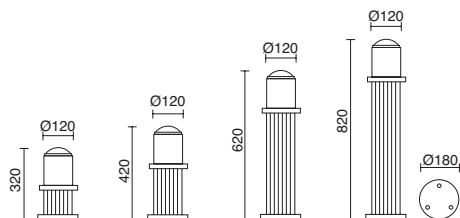

### h320

E27 Led/Hal/Fluo 70W max.

- O68A-G05X1A-02
- O68A-G05X1A-04

### h420

E27 Led/Hal/Fluo 70W max.

- O68B-G05X1A-02
- O68B-G05X1A-04

### h620

E27 Led/Hal/Fluo 70W max.

- O68C-G05X1A-02
- O68C-G05X1A-04

### h820

E27 Led/Hal/Fluo 70W max.

- O68D-G05X1A-02
- O68D-G05X1A-04



Acabado negro o antracita / Black or anthracite finish

Lamps p.791



Instalar sobre suelo rígido. En césped o tierra, añadir pilastra de cemento.  
Install on rigid ground. On grass or earth, add pilaster cement.

Consultar otras opciones de acabado.  
Consult other finishing options.

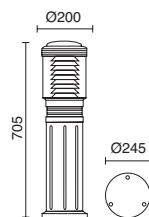

E27 Led/HaL/Fluo 42W max.

■ 114A-G05X1A-02

■ 114A-G05X1A-03



Acabado negro o antracita / Black or anthracite finish

Lamps p.791



Instalar sobre suelo rígido. En césped o tierra, añadir pilastra de cemento.  
Install on rigid ground. On grass or earth, add pilaster cement.

Consultar otras opciones de acabado.  
Consult other finishing options.



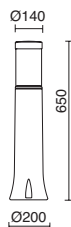

**3000K**  
LED SMD 13W 1200lm

**4000K**  
LED SMD 13W 1200lm

■ 669B-LO113B-02

■ 669B-LO213B-02



669C-



669D-



669A-



E27 Led/Fluo 11W max.

■ 669C-G05X1A-02



E27 Led/Fluo 11W max.

■ 669D-G05X1A-02



E27 Led/Fluo 23W max.

■ 669A-G05X1A-02



Acabado negro / Black finish



Lamps p.791



Instalar sobre suelo rígido. En césped o tierra, añadir pilastra de cemento.  
Install on rigid ground. On grass or earth, add pilaster cement.



# Urban lighting



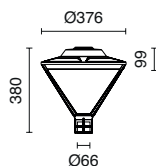

**3000K**  
LED SMD 47W 8240lm

■ 1035A-L3150AAO-02

**4000K**  
LED SMD 47W 9050lm

■ 1035A-L3350AAO-02

Postes / Poles p. 763

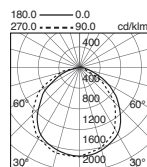

Acabado antracita / Anthracite finish



# VENT

Video

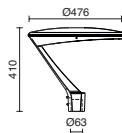

**3000K**  
LED SMD **36W** 5770lm

■ 1001A-L3140A90-04

**N** ■ 1001A-L3140A9D-04

LED SMD **68W** 10750lm

■ 1001A-L3175A90-04

**N** ■ 1001A-L3175A9D-04

**4000K**  
LED SMD **36W** 6000lm

■ 1001A-L3340A90-04

**N** ■ 1001A-L3340A9D-04

LED SMD **68W** 11800lm

■ 1001A-L3375A90-04

**N** ■ 1001A-L3375A9D-04

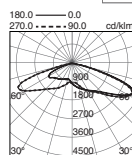

**3000K**  
LED SMD **36W** 5770lm

■ 1001B-L3140A90-04

**N** ■ 1001B-L3140A9D-04

LED SMD **68W** 10750lm

■ 1001B-L3175A90-04

**N** ■ 1001B-L3175A9D-04

**4000K**  
LED SMD **36W** 6000lm

■ 1001B-L3340A90-04

**N** ■ 1001B-L3340A9D-04

LED SMD **68W** 11800lm

■ 1001B-L3375A90-04

**N** ■ 1001B-L3375A9D-04

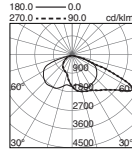

Acabado antracita / Anthracite finish

Consultar otras opciones de regulación  
Consult other regulation options



Incorpora válvula depresora para evitar la entrada de humedad.  
It incorporates a depressor valve to prevent the entry of moisture.

Postes / Poles p. 763

FENDER





Video

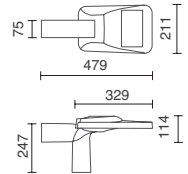

**3000K**  
LED SMD **21W** 3025lm

■ 999A-LO125A-04

**4000K**  
LED SMD **21W** 3505lm

■ 999A-LO225A-04

LED SMD **47W** 6770lm

■ 999A-LO150A-04

LED SMD **47W** 7615lm

■ 999A-LO250A-04

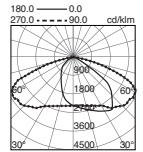

**3000K**  
LED SMD **21W** 3025lm

■ 999B-LO125A-04

**4000K**  
LED SMD **21W** 3505lm

■ 999B-LO225A-04

LED SMD **47W** 6770lm

■ 999B-LO150A-04

LED SMD **47W** 7615lm

■ 999B-LO250A-04

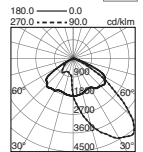

2 posiciones y orientación de  $\pm 15^\circ$   
2 positions and  $\pm 15^\circ$  orientable

Postes / Poles p. 763



Acabado antracita / Anthracite finish

Conector IP67 incluido  
IP67 connector included

Consultar opciones de regulación  
Consult regulation options



■ Negro / Black

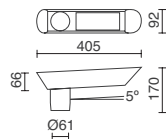

### 2700K

LED SMD 27W 4000lm

■ 673A-L3024A-39

LED SMD 24W 3600lm

■ 673A-L3024AAD-39

LED SMD 36W 4800lm

■ 673A-L3036A-39

LED SMD 36W 4900lm

■ 673A-L3036AAD-39

### 3500K

LED SMD 27W 4150lm

■ 673A-LO224A-39

LED SMD 24W 3700lm

■ 673A-L3224AAD-39

LED SMD 36W 5000lm

■ 673A-LO236A-39

LED SMD 36W 5100lm

■ 673A-L3236AAD-39

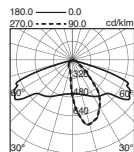

Acabado aluminio anodizado / Anodized aluminium finish

IK06 (lente / lens)  
IK10 (cubierta / cover)

Consultar opciones de regulación  
Consult regulation options

# VICO

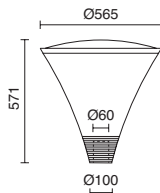

### 3000K

LED SMD 32W 4040lm

■ 568A-LO135B-04

LED SMD 50W 5530lm

■ 568A-LO150B-04

### 4000K

LED SMD 32W 4230lm

■ 568A-LO235B-04

LED SMD 50W 5785lm

■ 568A-LO250B-04



Acabado antracita / Anthracite finish

# POSTES / POLES

URBAN LIGHTING

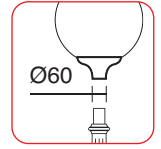
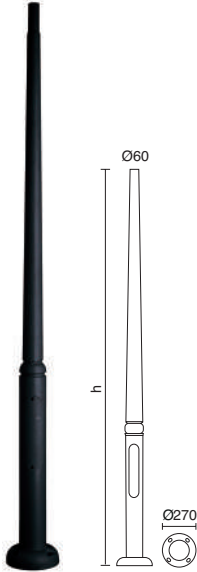

- C04A-32-02 (h3000)
- C04B-32-02 (h3500)
- C04C-32-02 (h4000)
- C04D-32-02 (h4500)
- C04E-32-02 (h5000)



RESIN

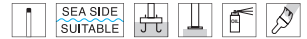

Acabado negro / Black finish

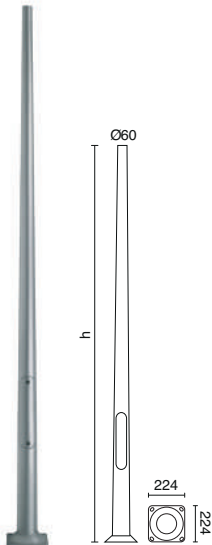

- |                      |                      |
|----------------------|----------------------|
| ■ C02B-32-02 (h3000) | ■ C03B-32-39 (h3000) |
| ■ C02C-32-02 (h3500) | ■ C03C-32-39 (h3500) |
| ■ C02D-32-02 (h4000) | ■ C03D-32-39 (h4000) |
| ■ C02F-32-02 (h5000) | ■ C03F-32-39 (h5000) |

ALU ANOD



Acabado negro o aluminio anodizado / Black or anodised aluminium finish

Consultar disponibilidad de acabados pintados RAL  
Consult availability of RAL painted finishes

## Anclaje / Anchorage

A02D-004-00



Caja de conexión opcional  
Optional junction box

500V 80A D01/E14-16A (273x90x76cm)

B03F-X33X1A-29



Instalar sobre suelo rígido. En césped o tierra, añadir pilastra de cemento.  
Install on rigid ground. On grass or earth, add pilaster cement.



Decorative

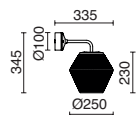

LED COB AC 6W 515lm 3000K

■ 857H-L3106B-58

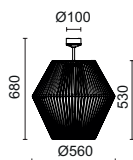

E27 LED 15W max.

■ 857D-G05X1A-58

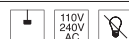

ALU + INOX + RATAN 

 IP 65

Acabado grafito / Graphite finish

Lamps p.791

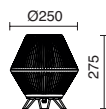

LED COB AC 6W 515lm 3000K

■ 857C-L3106B-58



LED SMD AC 2W 200lm 3000K

■ 857C-L3102L-58



Ø560

E27 LED 15W max.

■ 857B-G05X1A-58



Ø780

E27 LED 15W max.

■ 857A-G05X1A-58

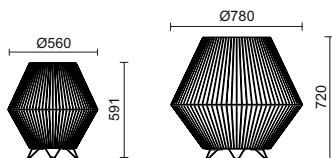

ALU + INOX + RATAN

Acabado grafito / Graphite finish

Lamps p.791

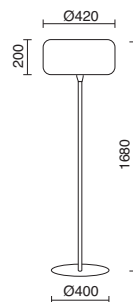

E27 Led/Hal/Fluo 42W max.

■ 458A-G05X1A-04



Acabado antracita / Anthracite finish

Lamps p.791



# CYLINDER

DECORATIVE

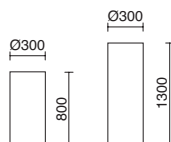

**h800**

E27 FLUO 33W max.

□ 394A-G05X1A-01

**h1300**

E27 FLUO 33W max.

□ 394B-G05X1A-01

PE



110V  
240V  
AC



IP  
55



SEA SIDE  
SUITABLE



Acabado blanco / White finish

Lamps p.791

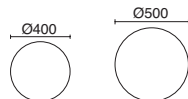

**Ø400**  
E27 Led/Fluo max. 25W

□ 393A-G05X1A-01

**Ø500**  
E27 Led/Fluo max. 25W

□ 393B-G05X1A-01

PE



Acabado blanco / White finish

Lamps p.791



Anemos Luxury Grand Resort, Greece



**h300**  
E27 Led/Fluo max. 15W

□ 392A-G05X1A-01



**h430**  
E27 Led/Fluo max. 25W

□ 392B-G05X1A-01

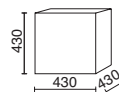
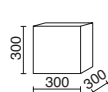

**h300**  
E27 Led/Fluo max. 15W

□ 392C-G05X1A-01



PE



Acabado blanco / White finish

Lamps p.791



# Underwater lighting



**>5700K**  
LED SMD 16W - 24VA 1485lm

233B-L2416D-03

**>5700K**  
LED SMD 58W - 60VA 4320lm

387A-L2458D-03

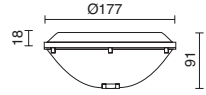

**RGB**  
LED SMD 15W - 23VA

233A-L2415D-04

**RGB**  
LED SMD 27W - 37VA

233A-L2427D-04

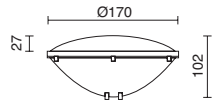

1 lámpara ilumina 20m<sup>2</sup> en piscinas y no en fuentes (altura).  
1 lamp light 20m<sup>2</sup> in swimming pools, but not in fountains (height).

En funcionamiento SIEMPRE SUMERGIDA (hasta 2m).  
Keep ALWAYS UNDER WATER when ON (up to 2m).

En reposición de la lámpara, recomendamos cambiar la junta tórica.  
For lamp replacement, we recommend changing the toric joint.

## Junta tórica / Toric joint

A11A-233-00



### Alimentadores / Power supplies

Max. 350W (160x130x100mm)

Max. 700W (210x140x110mm)

B02I-X33F9D-02

B02I-X33G1D-02

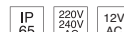

IN OUT

# KIT PAR56

UNDER WATER LIGHTING



386A-

Kit 1 lámpara PAR56 LED wireless + mando a distancia.  
Kit 1: One LED PAR56 wireless lamp plus one remote control.



386B-

Kit 2 lámparas PAR56 LED wireless + mando a distancia.  
Kit 2: Two LED PAR56 wireless lamps plus one remote control.

RGB

LED SMD RGB 27W - 37VA

386A-L0427D-00

RGB

LED SMD RGB 2x 27W - 37VA

386B-L0427D-00

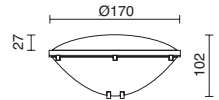

Selección de colores mediante movimientos verticales.  
Colour change through vertical movement.



- |   |   |    |   |
|---|---|----|---|
| 1 | ● | 7  | ● |
| 2 | ● | 8  | ● |
| 3 | ● | 9  | ● |
| 4 | ● | 10 | ● |
| 5 | ● | 11 | ● |
| 6 | ● | 12 | ○ |

Selección de secuencias mediante movimientos horizontales.  
Sequence change through horizontal movement.



- |   |   |   |   |   |
|---|---|---|---|---|
| 1 | ● | ● | ● | ● |
| 2 | ● | ● | ● | ● |
| 3 | ● | ● | ● | ● |
| 4 | ● | ● | ● | ● |
| 5 | ● | ● | ● | ● |
| 6 | ● | ● | ● | ● |
| 7 | ● | ● | ● | ● |
| 8 | ● | ● | ● | ● |



1 lámpara ilumina 20m<sup>2</sup> en piscinas y no en fuentes (altura).  
1 lamp light 20m<sup>2</sup> in swimming pools, but not in fountains (height).

En funcionamiento SIEMPRE SUMERGIDA (hasta 2m).  
Keep ALWAYS UNDER WATER when ON (up to 2m).

## Junta tórica / Toric joint

A11A-233-00

	<b>Alimentadores / Power supplies</b>							
	Max. 350W (160x130x100mm)	Max. 700W (210x140x110mm)						
B02I-X33F9D-02	B02I-X33G1D-02	<table border="1"> <tr> <td>IP 65</td> <td>220V 240V AC</td> <td>12V AC</td> </tr> <tr> <td colspan="2">IN</td> <td>OUT</td> </tr> </table>	IP 65	220V 240V AC	12V AC	IN		OUT
IP 65	220V 240V AC	12V AC						
IN		OUT						

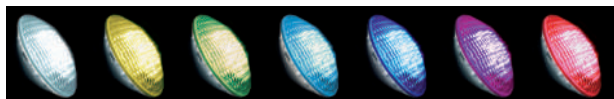

## CON PULSADOR / WITH PUSH BUTTON



Pulsador de circuito cerrado con aplicación de superficie.  
Closed-loop button device with surface application.

B01A-X33X2A-03

(max. 5 unds.)

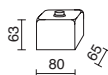

IP  
65

*Mediante cada pulsación se efectúa un cambio entre 7 colores y 8 secuencias.  
Each push of the button brings about a change between colours and 8 sequences.*

*Instalar entre el interruptor y el transformador (no incluido).  
Install between the switch and the transformer (not included).*

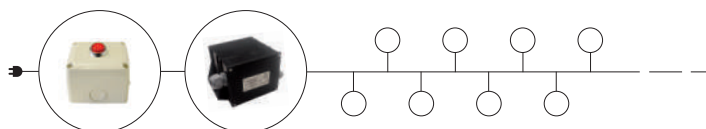

## CON MANDO A DISTANCIA / WITH REMOTE CONTROL



Receptor-modulador con antena.  
Receiver-modulator with antenna.

B05B-X33X2B-01

+



Mando a distancia.  
Remote control.

B05A-X33X2X-02

Alcance / Scope: 50 m. 433 MHz.  
Batería / Power supply :  
Battery 23AE 12V. (6LR61).  
Dimensiones / Dimensions: 61 x 24 x 110 mm.

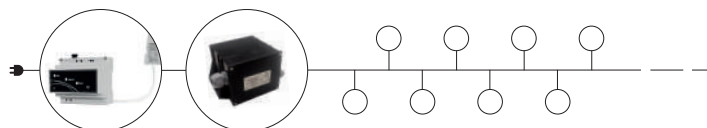

*Indispensable vincular el modulador con el mando.  
The modulator must be linked to the remote control.*

*¿Cómo sustituir o instalar una  
lámpara RGB de piscina y su  
sistema de control?*



Video

*How to replace or install an  
RGB pool light and its control  
system?*



Video

Consulte con nuestro departamento técnico cualquier proyecto con luminarias y sistemas de control RGB.  
Check with our technical department about RGB control system projects.





# BELT

UNDER WATER LIGHTING

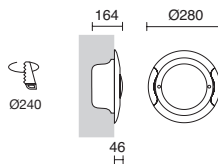

>5700K

LED SMD 16W - 24VA 1485 lm

RGB

LED SMD 27W - 37VA

□ 030A-L0316D-01

□ 030A-L0427D-01

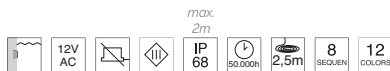

Acabado blanco / White finish

# PRAGA

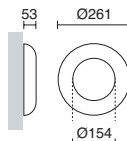

>5700K

LED SMD 16W - 24VA 1485 lm

RGB

LED SMD 27W - 37VA

□ 253A-L0316D-01

□ 253A-L0427D-01



Acabado blanco / White finish

Disponible en acero inoxidable.  
Available in stainless steel.

Instalación en piscinas hormigonadas.  
En funcionamiento SIEMPRE SUMERGIDA (hasta 2m).  
Consultar opciones de instalación en piscinas prefabricadas y con liner.  
1 lámpara ilumina 20m<sup>2</sup> en piscinas y no en fuentes (altura).

Suitable for installation in concrete pools.  
Keep ALWAYS UNDER WATER when ON (up to 2m).  
Consult installation options in prefabricated pools and with liner.  
1 lamp lights 20m<sup>2</sup> in swimming pools, but not in fountains (height).

Disponibile con lámpara V2.  
Available with V2 lamp version.  
Disponibile DMX con lámpara V2.  
Available in DMX with V2 lamp version.



## Alimentadores / Power supplies

Max. 350W (160x130x100mm)

Max. 700W (210x140x110mm)

B02I-X33F9D-02

B02I-X33G1D-02



IN OUT





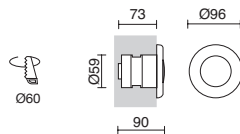

>5700K  
LED SMD 4W - 6VA 315 lm

RGB  
LED SMD RGB 4W - 7VA

□ 077A-L0304D-01

□ 077A-L0404D-01

Instalación en pequeñas piscinas.  
For installation in small pools.

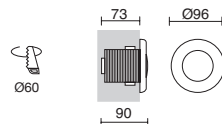

>5700K  
LED SMD 4W - 6VA 315 lm

RGB  
LED SMD RGB 4W - 7VA

□ 077B-L0304D-01

□ 077B-L0404D-01

Instalación en Spas.  
For installation in Spas.



Acabado blanco o inox / White or stainless steel finish

Válido para instalaciones fuera del agua.  
Suitable for installations outside water.

Disponible con diferentes ópticas.  
Available with different optics.

Disponible DMX.  
Available in DMX.

Disponible en blanco cálido.  
Available in warm white.



Sistema de Control RGB con mando a distancia.  
RGB Control System with remote control.  
Info p.776

<p><b>Alimentadores / Power supplies</b></p>	
<p>Max. 350W (160x130x100mm)</p> <p>■ B02I-X33F9D-02</p>	<p>Max. 700W (210x140x110mm)</p> <p>■ B02I-X33G1D-02</p>
<p>IP 65    220V 240V AC    12V AC</p> <p>IN    OUT</p>	

	<p><b>Caja de empotrar</b> Recessing box</p> <p>A12A-077-01</p>
--	---

	<p><b>Aro de acero inoxidable</b> Stainless steel ring</p> <p>A13A-077-30</p>	
<p>INOX</p>		





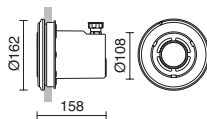

>5700K  
LED SMD 4W - 6VA 315 lm

RGB  
LED SMD RGB 4W - 7VA 186lm

□ 231A-L0304D-01

□ 231A-L0404D-01

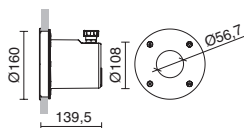

>5700K  
LED SMD 4W - 6VA 315 lm

RGB  
LED SMD RGB 4W - 7VA 186lm

■ 661A-L0304D-30

■ 661A-L0404D-30



Acabado blanco o inox / White or stainless steel finish

Consultar opciones de instalación en piscinas prefabricadas y con liner.  
Consult installation options in prefabricated pools and with liner.

Instalación en piscinas hormigonadas.  
Suitable for installation in concrete pools.

Válido para instalaciones fuera del agua.  
Suitable for installations outside water.

Disponibile con diferentes ópticas.  
Available with different optics.

Disponibile en blanco cálido.  
Available in warm white.



Sistema de Control RGB con mando a distancia.  
RGB Control System with remote control.  
Info p.776



### Alimentadores / Power supplies

Max. 350W (160x130x100mm)

Max. 700W (210x140x110mm)

■ B02I-X33F9D-02

■ B02I-X33G1D-02



IN OUT

# NINO

UNDER WATER LIGHTING

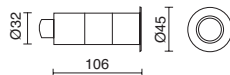

Para tubo PVC PN-16 Ø40.  
For tube PVC PN-16 Ø40.

>5700K

LED SMD 3W - 4VA 250lm

RGB

LED SMD RGB 3W - 4VA 150lm

■ 220B-L0203D-30

■ 220B-L0403D-30

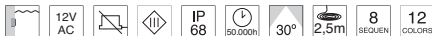

Acabado inox / Stainless steel finish

# LYNN



Base de acero inox.  
Stainless steel base.

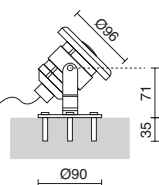

>5700K

LED SMD 4W - 6VA 315lm

RGB

LED SMD RGB 4W - 7VA 186lm

■ 187A-L0304D-32

■ 187A-L0404D-32

Disponible con diferentes ópticas.  
Available with different optics.



Acabado cromado / Chrome finish



Sistema de Control RGB con mando a distancia.  
RGB Control System with remote control.

Info p.776

Válido para instalaciones fuera del agua.  
Suitable for installations outside water.

Disponible DMX.  
Available in DMX.

Disponible en blanco cálido.  
Available in warm white.



Alimentadores / Power supplies

Max. 350W (160x130x100mm)

Max. 700W (210x140x110mm)

■ B02I-X33F9D-02

■ B02I-X33G1D-02



IN OUT

# GAMBLE MAXI

UNDER WATER LIGHTING

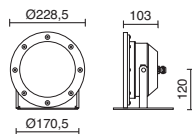

>5700K

LED SMD 58W - 60VA 4320lm

RGB

LED SMD RGB 48W - 64VA

■ 118B-LO358D-30

■ 118B-LO448D-30

# GAMBLE PLUS

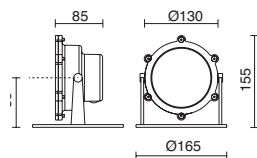

>5700K

LED SMD 16W - 23VA 1100lm

RGB

LED SMD RGB 22W - 31VA

■ 382A-LO316D-30

■ 382A-LO422D-30



Acabado inox / Stainless steel finish

Consultar opciones de instalación en piscinas prefabricadas y con liner.  
Consult installation options in prefabricated pools and with liner.



Sistema de Control RGB con mando a distancia.  
RGB Control System with remote control.

Info p.776

En funcionamiento SIEMPRE SUMERGIDA (hasta 2m).  
Keep ALWAYS UNDER WATER when ON (up to 2m).

Disponible con diferentes ópticas.  
Available with different optics.

Disponible DMX.  
Available in DMX.



## Alimentadores / Power supplies

Max. 350W (160x130x100mm)

Max. 700W (210x140x110mm)

■ B02I-X33F9D-02

■ B02I-X33G1D-02



IN OUT





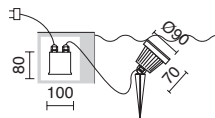

GU5.3 LED 3000K 5W (36°)

■ 113A-L2305B-02

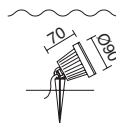
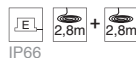

GU5.3 LED 3000K 5W (36°)

■ 113A-L2305D-02



**Alimentadores / Power supplies**

Max. 50W

■ B02J-X3350D-02

IP 65	220V 240V AC	12V AC
	IN    OUT	

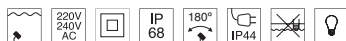

Acabado negro / Black finish

p.683



En funcionamiento SIEMPRE SUMERGIDA (hasta 2m).  
Keep ALWAYS UNDER WATER when ON (up to 2m).

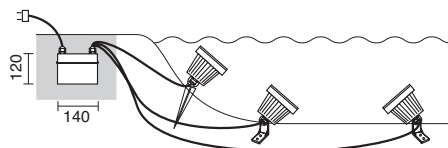

GU5,3 LED 3000K 3x5W (36°).

■ 113B-L2305B-02

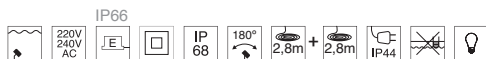

Acabado negro / Black finish

En funcionamiento SIEMPRE SUMERGIDA (hasta 2m).  
Keep ALWAYS UNDER WATER when ON (up to 2m).

p.683



ACCESSO

ORIES

# LED T2



**3000K/4000K/6500K**  
GX53 LED T2 3W 350lm

378A-L4103A-01

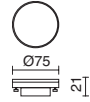

**4000K**  
GX53 LED T2 3W 350lm

378A-L3103A-02

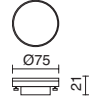

**3000K**  
GX53 LED T2 6W 480lm

378A-L3106A-01

**4000K**  
GX53 LED T2 6W 480lm

378A-L3106A-02

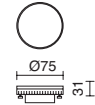

**4000K**  
GX53 LED T2 7W 700lm

378B-L3107A-02

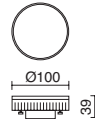

**3000K/4000K/6500K**  
GX53 LED T2 10W 1200lm

378B-L5210A-01

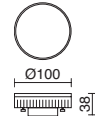

**2700K/3000K/4000K**  
GX53 LED T2 11W 1300lm

378C-L4111A-01

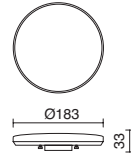

**3000K**  
GX53 LED T2 11W 1300lm

378C-L3111A-01

**4000K**  
GX53 LED T2 11W 900lm

378C-L3111A-02

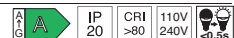

# LED FILAMENT



<b>2700K</b> E27 LED 6W 800lm 632C-L0506B-01	<b>4000K</b> E27 LED 6W 800lm 632C-L0506B-02
--	--

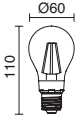

E27 LED 4W 450lm 2000K-2500K (Ø45)  
632H-L0504B-01



**3000K**  
E27 LED 3W 330lm (Ø45)  
632J-L0503B-01



**2700K**  
E27 LED 4W 470lm  
632F-L0504B-01

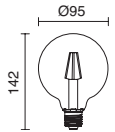

**2700K**  
E27 LED 4W 470lm  
632G-L0504B-01

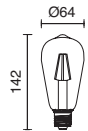

**2700K**  
E14 LED 4W 470lm 2700K  
632D-L0404B-01

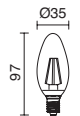

**2700K**  
E14 LED 4W 470lm 2700K  
632E-L0404B-01

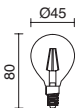

# LED PRO



**2700K/4000K** **4000K**  
 GU10 LED 3,5W 350lm GU10 LED 3,5W 400lm

578A-L4104A-01  
 K  
 SELECT

578A-L2104A-02

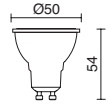
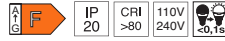

**N**  
**3000K/4000K**  
 LED MODUL 6W 560lm/620 lm

578B-L4106B-01

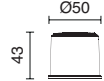
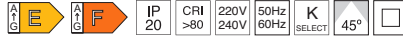

## G9



**3000K**  
 G9 LED 2,5W 160lm  
 369D-L2003B-01

**4000K**  
 G9 LED 2,5W 160lm  
 369D-L2003B-02



**3000K**  
 G9 LED 1,7W 150lm  
 967A-L0102A-01

**4000K**  
 G9 LED 1,7W 150lm  
 967A-L0102A-02

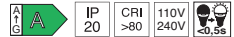

## R7s

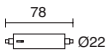

R7s LED 3,5W  
 968A-L4104A-02

2700K	325lm
4000K	365lm
6500K	365lm

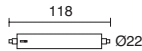

R7s LED 7,5W  
 968B-L4108A-02

2700K	680lm
4000K	775lm
6500K	790lm

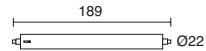

R7s LED 10,5W  
 968C-L4111A-02

2700K	1000lm
4000K	1130lm
6500K	1160lm

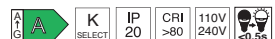



## CONNECTEURS CONNETTORI



Connecteur double (3 pôles) pour câbles-gaines de Ø5-13 mm.  
Connettore doppio (3 poli) per cavi-guaine con Ø5-13 mm.

B03A-X33X2A-02



Connecteur triple (3 pôles) pour câbles-gaines de Ø7-13.5 mm.  
Tripla connettore (3 poli) per cavi-guaine con Ø7-13.5 mm.

B03B-X33X2A-02

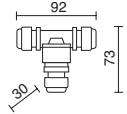

Connecteur triple (3 pôles) pour câbles-gaines de Ø13.5 mm.  
Tripla connettore (3 poli) per cavi-guaine con Ø13.5 mm.

B03C-X33X2A-02

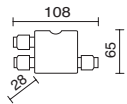

Connecteur triple (3 pôles) pour câbles-gaines de Ø13.5 mm.  
Tripla connettore (3 poli) per cavi-guaine con Ø13.5 mm.

B03D-X33X2A-02

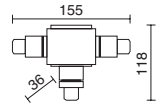

Double connecteur (3 pôles) pour câbles-gaines entre Ø7-12 mm.  
Doppio connettore (3 poli) per cavi-guaine tra Ø7-12 mm.

B03G-X33X2A-02

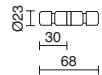

Double connecteur (4 pôles) pour câbles-gaines entre Ø7-12 mm.  
Doppio connettore (4 poli) per cavi-guaine tra Ø7-12 mm.

B03H-X33X2A-02

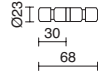

Double connecteur (5 pôles) pour câbles-gaines entre Ø5-13 mm.  
Doppio connettore (5 poli) per cavi-guaine tra Ø5-13 mm.

B03I-X33X2A-02

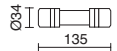



Triple connecteur (5 pôles) pour câbles-gaines entre Ø7-13.5 mm.  
Tripla connettore (5 poli) per cavi-guaine tra Ø7-13.5 mm.

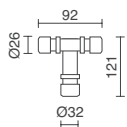

B03J-X33X2A-02









## ALIMENTATEURS ALIMENTATORI

	REF.	OUT				IN		SIZES	IP
		V	C	220-240V	110-127V	V	Freq.		
	B02A-X3317H-01	-	350 mA DC	0-17W	0-12W	100-240 V AC	50/60 Hz	122x38x28	20
	B02A-X3320J-01	-	500 mA DC	0-20W				120x40x20	
	B02A-X3317J-01	-	700 mA DC	0-17W				122x38x28	
	B02G-X3306J-01	-	700 mA DC	6W	-	100-240 V AC	50/60 Hz	58x40x20	20
	B02N-X3330J-01	-	700 mA DC	30W	-	220-240 V AC	50/60 Hz	147x44x22	20





ON DIP  
 Courant de sortie réglable  
 Corrente di uscita regolabile

	REF.	OUT				IN		SIZES	IP
		V	C	220-240V	110-127V	V	Freq.		
	B02N-X3340M-01	-	800 mA DC 900 mA DC 1050 mA DC	40W	-	220-240 V AC	50/60 Hz	147x43x30	20
	B02P-X3326HI-01	-	350 mA DC 500 mA DC 700 mA DC	26W	-	100-240 V AC	50/60 Hz	108x64x32	67
	B02P-X3340JM-01	-	500 mA DC 700 mA DC 1050 mA DC	40W	-	100-240 V AC	50/60 Hz	116x64x32	67

	REF.	OUT				IN		SIZES	IP
		V	C	220-240V	110-127V	V	Freq.		
	B02B-X3360B-01	12 V AC	-	60W	-	220-240 V AC	50/60 Hz	22x36x103	20
	B02B-X33A4B-01	-	-	150W	-			33x37x185	
	B02E-X3330E-00	12 V DC	-	30W	-	220-240 V AC	50/60 Hz	131x42x34	67
	B02E-X3375E-00	-	-	75W	-			155x50x32	65
	B02J-X3350D-02	12 V AC	-	50W	-	220-240 V AC	50/60 Hz	80x78x60	65
	B02M-X33A5D-03	12 V AC	-	200W	-	230 V AC	50/60 Hz	108x104x99	20
	B02M-X33A9D-03	-	-	500W	-			120x132x108	
	B02C-X33A7D-02	12 V AC	-	300W	-	230 V AC	50 Hz	120x140	66
	B02I-X33F9D-02	12 V AC	-	350W	-	220-240 V AC	50/60 Hz	175x155x110	65
	B02I-X33G1D-02	12 V AC	-	700W	-	220-240 V AC	50/60 Hz	175x155x110	
	B02F-X33A8D-32	12 V AC	-	400W	-	230 V AC	50 Hz	220x110	20

## ALIMENTATEURS ALIMENTATORI

24V DC	REF.	OUT				IN		SIZES	IP
		V	C	220-240V	110-127V	V	Freq.		
	B02A-X332F-01	24 V DC	-	15W	-	200-240 V AC	50/60 Hz	111,5x44x19,1	20
	B02Q-X3325F-01	24 V DC	-	25W	25W	90-295 V AC	50/60 Hz	84x57x29,5	42
	B02Q-X3335F-00		-	35W	35W	90-264 V AC			
	B02Q-X3312F-01	24 V DC	-	12W	12W	90-264 V AC	50/60 Hz	77x40x29	42
	B02Q-X3396F-00	24 V DC	-	96W	96W	90-264 V AC	50/60 Hz	200,5x69,5x35	20
	B02R-X33A1F-01	24V DC	-	100W	100W	90-264 V AC	50/60 Hz	191x63x37,5	67
	B02Y-X33A1F-00	24V DC	-	100W	100W	220-240V AC	50/60 Hz	206x68,6x37	67
	B02Y-X33A4F-00	24V DC	-	150W	150W	220-240 V AC	50/60 Hz	206x68,6x37	67
	B02C-X3330F-00	24V DC	-	30W	-	220-240 V AC	50/60 Hz	153x41x32	20
	B02C-X3360F-00	24V DC	-	60W	-	220-240 V AC	50/60 Hz	180x52x30	20
	B02C-X3375F-00		-	75W	-	220-240 V AC	50/60 Hz	180x52x30	20
	B02C-X33A3F-00		-	120W	-	220-240 V AC	50/60 Hz	330x40x30	20
B02Y-X3330F-00	24V DC		-	30W	-	220-240 V AC	50/60 Hz	131x42x34	67
	B02Y-X3375F-00	24V DC	-	75W	-	220-240 V AC	50/60 Hz	155x49x32	67
	B02R-X3375F-00	24V DC	-	35W	35W	90-264 V AC	50/60 Hz	148x40x30	67
	B02R-X3360F-00	24V DC	-	60W	60W	90-264 V AC	50/60 Hz	162,5x42,5x32	67
	B02R-X33A4F-00	24V DC	-	150W	-	180-305 V AC	50/60 Hz	191x63x37,5	67
	B02H-X3360F-00 DALI	24V DC	-	60W	60W	90-305 V AC	50/60 Hz	150x53x35	67
	B02H-X3390F-00 DALI	24V DC	-	90W	90W	90-305 V AC	50/60 Hz	171x63x37,5	67
	B02H-X33A3F-00 DALI	24 V DC	-	120W	120W	90-305 V AC	50/60 Hz	190x52x37,5	67
	B02H-X33A5F-00 DALI	24 V DC	-	200W	200W	100-305 V AC	50/60 Hz	195x63x39,5	67

48V DC	REF.	OUT				IN		SIZES	IP
		V	C	220-240V	110-127V	V	Freq.		
	B02V-X3375V-00	48 V DC	-	75W	-	220-240 V AC	50/60 Hz	180x52x30	20
	B02V-X33J5V-00	48 V DC	-	120W	-	220-240 V AC	50/60 Hz	300x40x30	20
	B32N-X33A1V-02	48 V DC	-	100W	-	220-240 V AC	50/60 Hz	207,5x16x19	20
	B32N-X33A6V-02	48 V DC	-	250W	-	220-240 V AC	50/60 Hz	268x22x43,5	20





# FINITIONS FINITURE

Les articles de ce catalogue sont fournis selon le modèle, avec des finitions différentes. Celles-ci sont représentées par les deux derniers chiffres du code ou, dans certains modèles, vous pouvez même trouver 4 chiffres de finition et un cadre de couleur. La couleur sur les photos de produit est indicative en raison des variations de teintes causées par le processus d'impression.

 -01 Blanc — Bianco

 -02 Noir — Nero

 -03 Gris — Grigio

 -04 Anthracite — Antracite

 -05 Vert — Verde

 -06 Bleu — Blu

 -07 Rouge — Rosso

 -09 Beige — Beige

 -11 Ivoire — Avorio

 -13 Gris pierre — Grigio pietra

 -14 Marron — Marrone

 -27 Opaline — Cristallo Opale

 -28 Nuancé — Marmorizzato

 -29 Transparent — Trasparente

 -30 Inox — Inox

 -32 Chrome — Cromo

 -33 Laiton vieilli — Ottone invecchiato

 -34 Laiton — Ottone

 -35 Nickel satiné — Nichel satinato

 -37 Cuivre — Rame

 -38 Acier zingué — Acciaio zincato

 -39 Aluminium anodisé — Alluminio anodizzato

 -40 Aluminium brossé — Alluminio spazzolato

 -41 Acier galvanisé — Acciaio zincato a caldo

Gli articoli di questo catalogo sono forniti secondo il modello, con diverse finiture. Queste sono rappresentate dalle ultime due cifre del codice o, in alcuni modelli, è possibile trovare addirittura 4 cifre di finitura e un riquadro di colore. Il colore nelle fotografie del prodotto è indicativo a causa delle variazioni di tonalità causate dal processo di stampa.

 -43 Inox brossé — Acciaio inossidabile spazzolato

 -45 Chromé mat — Cromato opaco

 -46 Or mat — Oro opaco

 -47 Or — Oro

 -48 Nickel mat — Nichel opaco

 -50 Bois de hêtre — Legno di faggio

 -51 Bois de chêne — Legno di rovere

 -53 Fibre naturelle beige — Fibra naturale beige

 -54 Fibre naturelle marron — Fibra naturale marrone

 -57 Bois d'ébène — Legno d'acero

 -58 Rotin graphite — Rattan grafite

 -59 Bois de noyer — Legno di noce

 -60 Pierre Leccese — Pietra Leccese

 -61 Pierre Leccese Anthracite —  
Pietra Leccese Antracite

 -63 Pierre Leccese Rouge Brique —  
Pietra Leccese Rosso Mattone

 -71 Pierre de lave — Pietra Lavica

 -80 Neolith Nero Zimbabwe

 -81 Neolith Phedra Satin

 -82 Neolith Iron Moss Satin



 -83 Neolith La Bohème NH

 -90 Marron oxyde — Marrone ossido

 -91 Marron cuivré — Marrone ramato

 -92 Verre transparent — Cristallo trasparente

## FINITIONS FINITURE

 **-BL** Bleu clair — Blu chiaro **-BR** Bronze — Bronzo **-CA** Cotton White **-CB** Cotton Black **-CC** Cotton Beige **-CE** Cotton Capuccino **-CG** Cotton Earth **-CJ** Cotton Red **-CK** Cotton Grey **-D1** White synthetic fabric **-D2** Beige synthetic fabric **-D3** Brown synthetic fabric **-D4** Black synthetic fabric **-DC** Eco Beige **-FG** Gris Fumé **-HC** Yute Beige **-M1** Osier clair — Vimini chiaro **-M2** Osier foncé — Vimini scuro **-MK** Moka — Moka **-NB** Béton anthracite — Cemento antracite **-NN** Béton naturel — Cemento naturale **-NR** Béton rouge — Cemento rosso **-NW** Béton blanc — Cemento bianco **-R1** Raphia Bali — Rafia Bali **-RA** Ribbon wrapped white **-RB** Ribbon wrapped Black **-RC** Ribbon wapped beige **-SA** Synthetic white **-SB** Synthetic black **-SC** Lin Marron — Lino marrone **-SG** Synthetic gold **-SM** Synthetic Copper **-T1** Trame 1 — Trama 1 **-W1** Bois foncé — Legno scuro **-W2** Bois clair — Legno chiaro **-W3** Bois naturel — Legno naturale

## FINITIONS SPÉCIALES — FINITURE SPECIALI



Tous nos modèles avec des finitions de couleur noire peuvent être fournis avec une patine à la main. L'uniformité de cette technique est aléatoire en raison du processus artisanal et entraîne un supplément de 18 % ainsi qu'un délai de livraison maximal de 6 jours ouvrables après la livraison standard.

Tutti i nostri modelli con finiture in colore nero possono essere forniti patinati a mano. L'uniformità di questa tecnica è casuale a causa del processo artigianale e comporta un sovrapprezzo del 18% e un periodo di consegna massimo di 6 giorni lavorativi dopo la consegna standard.



\*  
Noir-argent patiné —  
Black-silver



Noir-marron patiné —  
Nero-marrone patinato

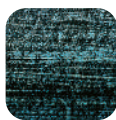

Noir-vert patiné —  
Nero-verde patinato

\*  
Finition non garantie pendant 3 ans, car elle peut se détériorer au contact de l'eau et de l'exposition solaire.

Finitura non garantita per 3 anni, poiché può deteriorarsi a contatto con l'acqua e l'esposizione solare.

## MATÉRIAUX MATERIALI

 Corps Corpo

 Cadre (Arc) Telaio (Anello)

 Réflecteur Riflettore

 Diffuseur Diffusore

ABS	Plastique ABS	Plastica ABS
ACER	Acier	Acciaio
ALU	Aluminium	Alluminio anodizzato
ALU ANOD	Aluminium anodisé	Alluminio anodizzato
ALU FACET	Aluminium facetté	Alluminio sfaccettato
BRASS	Laiton	Ottone
CERAMIC	Céramique	Ceramica
COTTON	Coton	Cotone
CONCRETE	Béton	Cemento
Cu	Cuivre	Rame
GLASS	Verre	Cristallo
GLASS AMBER	Verre ambré	Cristallo ambra
GLASS FACET	Cristal facetté	Cristallo sfaccettato
GLASS MAT	Cristal nuancé	Cristallo sfumato
GLASS OPAL	Cristal opalisé	Cristallo opalizzato
GLASS PRISM	Cristal prismatique	Cristallo a prismi
GLASS TRANS	Cristal transparent	Cristallo trasparente
INOX	Acier inoxydable	Acciaio inossidabile
LINEN	Lin	Lino
NAT FIBER	Fibre naturelle	Fibra naturale
PA	Polyamide	Poliammide
PC	Polycarbonate	Policarbonato
PC MAT	Polycarbonate nuancé	Policarbonato sfumato
PC OPAL	Polycarbonate opalisé	Policarbonato opalizzato
PC PRISM	Polycarbonate prismatique	Policarbonato a prismi
PC TRANS	Polycarbonate transparent	Policarbonato trasparente
PE	Polyéthylène	Polietilene
PES	Polyester	Poliestere
PLASTER	Plâtre	Gesso
PMMA	Méthacrylate	Metacrilato
PMMA FUME	Metacrilato ahumado	Smoked methacrylate
PMMA MAT	Méthacrylate fumé	Metacrilato affumicato
PMMA OPAL	Méthacrylate opalisé	Metacrilato opalizzato
PMMA PRISM	Méthacrylate prismatique	Metacrilato a prismi
PMMA TRANS	Méthacrylate transparent	Metacrilato trasparente
PPH	Polypropylène homopolymère	Polipropilene omopolimero
PS	Polystyrène	Polistirene
PVC	Polychlorure de vinyle	Policloruro di vinile
RAFIA	Raphia	Rafia
RATAN	Rotin	Rattan
RESIN	Résine	Resina
RIBBON WRAPPED	Ruban enveloppé	Nastro avvolto
SILICON	Silicone	Silicone
STONE	Pierre	Pietra
SYNT	Synthétique	Sintetico
SYNT FIBER	Fibre synthétique	Fibra sintetica
TECNO POLIM	Technopolymère	Tecnopolimero
TERMO PLASTIC	Thermoplastique	Termoplastico
WOOD	Bois	Legno
ZAMAK	Alliage Zamak	Lega di Zama



# MATÉRIAUX MATERIALI

## Produits en acier inoxydable

L'acier inoxydable est un type d'acier résistant à la corrosion, car le chrome qu'il contient a une grande affinité pour l'oxygène et réagit avec lui pour former une couche passive d'environ un atome d'épaisseur, évitant ainsi la corrosion du fer. Cependant, cette couche peut être affectée par certains acides, ce qui entraîne une attaque et une oxydation du fer par des mécanismes intergranulaires ou des piqûres généralisées.

L'acier inoxydable que nous utilisons normalement pour nos produits est de type AISI 304, AISI 316 et AISI 316L avec une finition satinée ou brillante. Ce type de finition garantit une excellente performance en termes de durabilité, de force, ainsi que de facilité de nettoyage.

Des taches peuvent apparaître sur l'acier inoxydable en raison du contact avec l'atmosphère marine, des environnements humides, ainsi que du calcaire provenant de l'arrosage. Ce type de contamination sur l'acier inoxydable peut être éliminé en utilisant des produits nettoyants contenant de l'acide phosphorique.

## Produits en aluminium

L'aluminium est un élément chimique, de symbole Al et de numéro atomique 13. Il s'agit d'un métal non ferreux. C'est le troisième élément le plus courant dans la croûte terrestre. Les composés d'aluminium représentent 8 % de la croûte terrestre et sont présents dans la plupart des roches, de la végétation et des animaux. À l'état naturel, il se trouve dans de nombreux silicates (feldspaths, plagioclases et micas). En tant que métal, il est extrait du minerai appelé bauxite, d'abord transformé en alumine par le processus Bayer, puis en aluminium par électrolyse. Nos articles ont été protégés par chromatisation et finis avec des peintures en polyester, et leur détérioration peut se produire en raison de:

1. Un contact continu avec de l'eau ayant un pourcentage élevé de sel ou de l'eau acide contaminée par des engrais ou des insecticides.
2. L'électrolyse produite par le contact de l'aluminium avec les vis de fixation si elles sont en acier (il est recommandé d'utiliser des vis en acier inoxydable).
3. Le courant vagabond présent dans le sol, uniquement évitable avec une mise à la terre correcte.
4. La non-protection rapide de l'aluminium en cas d'arrachage de la peinture par frottement ou choc.

## Produits en polyamide

Une polyamide est un type de polymère qui contient des liaisons de type amide. Les polyamides peuvent être trouvés dans la nature, tels que la laine ou la soie, et peuvent également être synthétiques, comme le nylon ou le Kevlar. La polyamide, de plus en plus utilisée dans l'industrie, regroupe des matériaux tels que le polycarbonate, le polychlorure de vinyle ou le nylon. Tous présentent des caractéristiques communes : leur résistance à la destruction et leur longue durée de vie. Considéré comme l'un des matériaux les plus adaptés aux produits exposés à des températures extrêmes, à l'humidité, à l'eau de mer, aux rayons UV et aux engrais chimiques. La composition des matériaux en polyamide garantit une longue durée de vie, que ce soit dans des zones sèches ou humides. Leur détérioration peut survenir en raison de :

1. Mauvais traitement ou impact fort.
2. Proximité avec des espaces à haute température.
3. Contact avec des produits chimiques très acides.

## Prodotti in acciaio inossidabile



L'acciaio inossidabile è un tipo di acciaio resistente alla corrosione, poiché il cromo che contiene ha una grande affinità per l'ossigeno e reagisce con esso formando uno strato passivo di circa uno spessore atomico, evitando così la corrosione del ferro. Tuttavia, questo strato può essere influenzato da alcuni acidi, dando luogo a un attacco e a un'ossidazione del ferro attraverso meccanismi intergranulari o punture generalizzate.

L'acciaio inossidabile che utilizziamo normalmente per i nostri prodotti è del tipo AISI 304, AISI 316 e AISI 316L con una finitura satinata o lucida. Questo tipo di finitura garantisce un'eccellente prestazione in termini di durabilità, resistenza, oltre alla facilità di pulizia.

Sull'acciaio inossidabile possono comparire piccole macchie a seguito del contatto con l'atmosfera marina, ambienti umidi e anche dal calcare proveniente dagli irrigamenti. Questo tipo di contaminazione sull'acciaio inossidabile può essere eliminato con l'applicazione di prodotti detergenti contenenti acido fosforico.

## Prodotti in alluminio



L'alluminio è un elemento chimico, con simbolo Al e numero atomico 13. Si tratta di un metallo non ferroso. È il terzo elemento più comune trovato nella crosta terrestre. I composti di alluminio costituiscono l'8% della crosta terrestre e sono presenti nella maggior parte delle rocce, della vegetazione e degli animali. Allo stato naturale si trova in molti silicati (feldspati, plagioclasti e miche). Come metallo, viene estratto dal minerale noto con il nome di bauxite, prima trasformato in allumina mediante il processo Bayer e successivamente in alluminio mediante elettrolisi. I nostri articoli sono stati protetti con cromatizzazione e finiti con vernici in poliestere e il loro deterioramento può verificarsi a causa di:

1. Contatto continuo con acque ad alto contenuto di sale o acque acide contaminate da concimi o insetticidi.
2. Elettrolisi prodotta dal contatto dell'alluminio con le viti di fissaggio se sono di acciaio (si consigliano viti di acciaio inossidabile).
3. La corrente vagante presente nel terreno, evitabile solo con un adeguato sistema di messa a terra.
4. La mancata protezione rapida dell'alluminio nel caso in cui la vernice venga rimossa per sfregamento o urto.

## Prodotti in poliammide



Una poliammide è un tipo di polimero che contiene legami di tipo ammidici. Le poliammidi possono essere presenti in natura, come la lana o la seta, e possono anche essere sintetiche, come il nylon o il Kevlar. Le poliammidi, sempre più utilizzate nell'industria, includono materiali come policarbonato, polivinile o nylon. Tutti con caratteristiche comuni: la loro difficile distruzione e la loro lunga durata. Considerato uno dei materiali più adatti per prodotti esposti a temperature estreme, umidità, salsedine marina, raggi UV e fertilizzanti chimici. La composizione dei materiali in poliammide garantisce una lunga durata, sia in zone secche che umide. Il loro deterioramento può verificarsi a causa di:

1. Maltrattamenti o forti impatti.
2. Avvicinamento a spazi ad alta temperatura.
3. Contatto con prodotti chimici molto acidi.

# MATÉRIAUX MATERIALI

## Produits de résine

Les luminaires fabriqués en résine se distinguent par ces qualités :

1. Protégés contre la corrosion chimique sur une large plage d'acidités, de bases, de chlorures, de sels et de solvants organiques.
2. Protégés contre l'impact des rayons UV sur la peinture.
3. Excellente performance en isolation thermique et électrique (double isolation).
4. Résistance exceptionnelle aux chocs et à la fatigue.
5. Fabriqués avec des matériaux ignifuges.
6. Légers et faciles à transporter.
7. Maintenance minimale : nécessite un entretien périodique avec de l'huile synthétique pour retrouver la brillance.

## Prodotti in resina



Le lampade realizzate in resina si distinguono per queste qualità:

1. Protette contro la corrosione chimica in un ampio range di acidi, basi, cloruri, sali e solventi organici.
2. Protette dall'impatto della luce solare sulla vernice grazie ai raggi UV.
3. Eccellente comportamento in isolamento termico ed elettrico (doppio isolamento).
4. Straordinaria resistenza agli urti e alla fatica.
5. Realizzate con materiali ignifughi.
6. Leggere e facili da trasportare.
7. Manutenzione minima: richiede una manutenzione periodica con olio sintetico per ripristinare la lucentezza.

## Composition de nos colonnes en résine / Composizione delle nostre colonne in resina

1. Résine extérieure : poteau d'une seule pièce fabriqué résistant aux chocs; protégé contre l'impact des rayons UV; ignifuge et sans agents chimiques corrosifs.
2. Resina esterna: palo monoblocco resistente agli urti, protetto dall'impatto dei raggi UV; ignifugo e privo di agenti chimici corrosivi.

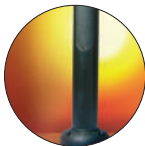

# RECOMMANDATIONS D'UTILISATION ET D'INSTALLATION

## RACCOMANDAZIONI PER L'USO E L'INSTALLAZIONE

### Encastrables au sol et bornes

Dans le cas d'installations de luminaires encastrés, celles-ci doivent toujours être réalisées par un personnel qualifié, avec la plus grande précaution et conformément aux instructions de montage fournies avec le produit, ainsi qu'aux normes d'installation électrique en vigueur. À prendre en compte dans ce type d'installations :

1. Évitez toujours de placer les luminaires dans des creux ou dépressions du terrain.
2. Il est indispensable de réaliser un drainage efficace pour tous les appareils (sable ou gravier de 25 à 30 mm) afin d'éviter la stagnation de l'eau au fond de la tranchée où les appareils sont installés. Un drainage correct doit permettre l'absorption de 5 litres d'eau en 8 minutes.
3. En ce qui concerne les appareils encastrés dans le béton ou le ciment, compte tenu de la tendance de ces matériaux à subir une dilatation ou une compression en raison des variations de température, il est nécessaire de prévoir un revêtement de dilataion et de s'assurer que la tranchée est parfaitement nivelée avec le sol.
4. La connexion entre les appareils doit être effectuée à l'aide d'un câble souple de type H05RN-F ou H07RN-F afin de faciliter la maintenance des appareils et d'éviter les contraintes sur les passages de câbles pendant l'installation. Il est important de respecter les instructions d'installation de chaque produit, en évitant l'installation de plusieurs câbles par une seule sortie ou l'installation avec des câbles unipolaires. Il est également recommandé d'utiliser des connecteurs étanches dans les installations enterrées pour éviter d'éventuels dommages dus à l'humidité.
5. Suivez attentivement les instructions de montage lors de l'installation et des opérations de maintenance. Pour une conservation correcte des bornes/lampadaires, nous vous recommandons de les monter sur une colonne élevée, jamais au niveau du sol, de la terre ou de l'herbe. Les changements de pression sont causés par une variation des conditions environnementales, en fonction de l'altitude où ils sont installés. Ils peuvent survenir en raison d'une concentration de chaleur lors de l'allumage du luminaire et lorsqu'il refroidit à l'extinction, ou en raison d'un choc thermique dû à la pluie, à la neige ou aux cycles de lavage.

Pour minimiser la possible condensation de la vapeur d'eau à l'intérieur des appareils avec un indice de protection élevé, il est recommandé de faire fonctionner la lampe pendant 1 heure sans le verre de protection/le boîtier, puis de le refermer immédiatement. Toutes les évaluations et décisions techniques doivent être prises par le responsable du département technique, limitant les commentaires ou propositions émanant de personnes extérieures à ce département.



Pendant le remplacement des lampes et avant de refermer les luminaires, il est nécessaire de nettoyer les joints afin d'éviter que des résidus de terre et/ou d'herbe ne s'accumulent.



Nel cambio delle lampade e prima di chiudere gli apparecchi illuminanti, è necessario pulire le guarnizioni per evitare che si depositino residui di terra e/o erba.

### Incasso a pavimento e fari



Nel caso di installazioni di apparecchi illuminanti incassati, queste devono sempre essere effettuate da personale qualificato, con la massima precauzione e in conformità alle istruzioni di montaggio fornite con il prodotto e alle norme di installazione elettrica vigenti. Da tenere presente in questo tipo di installazioni:

1. Evitare sempre di posizionare gli apparecchi illuminanti in avvallamenti o depressioni del terreno.
2. È indispensabile realizzare un drenaggio efficace per tutti gli apparecchi (sabbia o ghiaia da 25 a 30 mm) al fine di evitare il ristagno dell'acqua sul fondo della trincea in cui sono installati gli apparecchi. Un drenaggio corretto deve consentire l'assorbimento di 5 litri d'acqua in 8 minuti.
3. Per quanto riguarda gli apparecchi incassati nel cemento o nel calcestruzzo e dato il tendere di questi materiali a subire dilatazioni o compressioni a causa delle variazioni di temperatura, è necessario prevedere un rivestimento di dilatazione e assicurarsi che la trincea sia perfettamente livellata con il pavimento.
4. La connessione tra gli apparecchi deve essere effettuata tramite cavo flessibile di tipo H05RN-F o H07RN-F al fine di facilitare la manutenzione degli apparecchi e evitare sforzi sui passacavi durante l'installazione. È importante rispettare le istruzioni di installazione di ciascun prodotto, evitando l'installazione di più cavi per una singola uscita o l'installazione con cavi unipolari. È inoltre consigliabile utilizzare connettori stagni nelle installazioni interrato per evitare possibili danni da umidità.
5. Seguire attentamente le istruzioni di montaggio durante l'installazione e le operazioni di manutenzione. Per una corretta conservazione delle bolland/lampade, si consiglia di montarle su un pilastro elevato, mai a livello del suolo, della terra o dell'erba. Le variazioni di pressione sono causate da cambiamenti delle condizioni ambientali e dipendono dall'altitudine in cui sono installate. Possono essere generate da una concentrazione di calore quando la lampada è accesa e quando si sta raffreddando allo spegnimento, o da un colpo termico causato dalla pioggia, dalla neve o dai cicli di lavaggio.

Per minimizzare la possibile condensazione di vapore d'acqua all'interno degli apparecchi con un alto indice di protezione, si consiglia di far funzionare la lampada per 1 ora senza il vetro di protezione/alloggiamento e, trascorso quel periodo di tempo, chiuderlo immediatamente. Tutte le valutazioni e decisioni tecniche devono essere prese dal responsabile del dipartimento tecnico, limitando i commenti o le proposte provenienti da persone esterne a tale dipartimento.

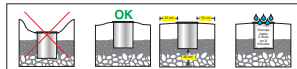

Ne pas installer plus d'un câble par sortie.  
Non installare più di un cavo per ogni uscita.



Installer sur une colonne à un niveau supérieur.  
Installare su una piastra a un livello superiore.



# RECOMMANDATIONS D'UTILISATION ET D'INSTALLATION POUR LES BANDES LED

## RACCOMANDAZIONI PER L'USO E L'INSTALLAZIONE DEI NASTRI LED

Ne pas plier la bande ou d'autres composants, car cela pourrait endommager les connexions. (1)

Ne pas toucher ni exercer de pression sur les LED pendant l'installation. (2)

Non piegare la striscia o altri componenti in quanto potrebbe danneggiare i collegamenti. (1)

Non toccare né esercitare pressione sui LED durante l'installazione. (2)

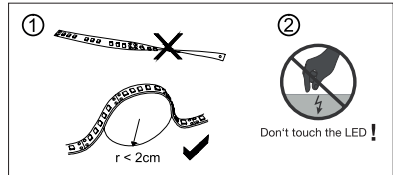

Ne connectez pas directement la bande de LED au réseau électrique. Elle doit être connectée uniquement à un contrôleur adéquat de 24V.

Non collegare direttamente la striscia LED alla rete elettrica. Deve essere collegata solo a un controllore adatto da 24V.



Évitez de placer les bandes dans des zones à température élevée ou exposées directement au soleil. Il est recommandé d'utiliser des profils en aluminium pour réduire la température de fonctionnement. (Indispensable pour les bandes de plus de 5W/m).

Evitare di posizionare le strisce in zone con temperatura elevata o luce diretta del sole. Si consiglia l'uso di profili in alluminio per ridurre la temperatura di funzionamento. (Indispensabile per strisce di più di 5W/m).

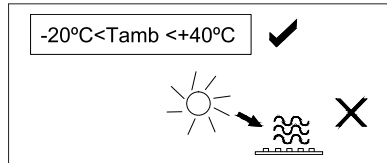

Veillez noter que les produits peuvent être endommagés par une décharge électrostatique (ESD). La mise à la terre est une mesure visant à éviter les effets nocifs de la décharge électrostatique. Par conséquent, lors du montage, un système de mise à la terre de protection personnelle doit être utilisé pour éviter l'accumulation de charge statique.

Si prega di notare che i prodotti possono essere danneggiati da scariche elettrostatiche (ESD). La messa a terra è una misura per evitare gli effetti dannosi delle scariche elettrostatiche. Pertanto, durante il montaggio, è necessario utilizzare un sistema di messa a terra per la protezione personale al fine di evitare l'accumulo di carica statica.

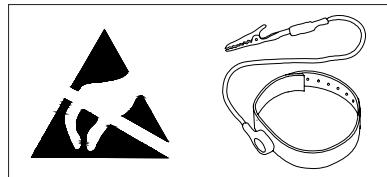

En fonction de la surface, utilisez un nettoyant multi-usages (par exemple, de l'alcool isopropylique) pour obtenir une surface de montage propre et sèche, dépourvue d'huiles, de revêtements antiadhésifs et de particules de saleté.

A seconda della superficie, utilizzare un detergente multiuso (ad esempio, alcol isopropilico) per ottenere una superficie di montaggio pulita e asciutta, priva di oli, rivestimenti antiaderenti e particelle di sporco.

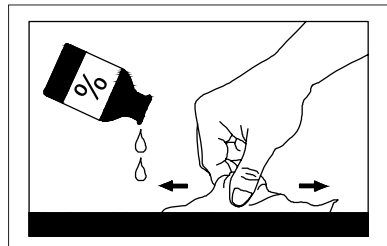

Si le produit doit être découpé sur mesure, veuillez mesurer avec soin et couper les marques de découpe indiquées en angle droit en utilisant uniquement des ciseaux bien affûtés.

Se il prodotto deve essere tagliato su misura, si prega di misurare con attenzione e tagliare le segnalazioni di taglio in angolo retto utilizzando solo delle forbici ben affilate.

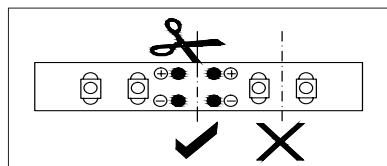

# RECOMMANDATIONS D'UTILISATION ET D'INSTALLATION POUR LES BANDES LED

## RACCOMANDAZIONI PER L'USO E L'INSTALLAZIONE DEI NASTRI LED

La distance maximale possible entre le convertisseur et les bandes dépendra de la section du câble utilisé. Il ne faut pas dépasser une chute de tension de 2V sur le conducteur entre la bande ou les bandes et le convertisseur. La section (S) du câble nécessaire est déterminée par la formule suivante, où :

$r$  est la résistivité ( $Cu = 0,017$ )

$L$  est la longueur en mètres de la ligne

$I$  est l'intensité en ampères

$V$  est la chute de tension maximale admissible

Les convertisseurs doivent prendre en compte les pertes dans la distribution. Il est conseillé de surdimensionner la puissance de ces derniers de 20 % pour couvrir ces pertes.

La massima distanza possibile tra il convertitore e le strisce sarà determinata dalla sezione del cavo utilizzato. Non bisogna superare una caduta di tensione di 2V sul conduttore tra la striscia o le strisce e il convertitore. La sezione (S) del cavo necessario è determinata dalla seguente formula, dove:

$r$  è la resistività ( $Cu = 0,017$ )

$L$  è la lunghezza in metri della linea

$I$  è l'intensità in ampere

$V$  è la caduta di tensione massima ammissibile

I convertitori devono considerare le perdite nella distribuzione. È consigliabile sovradimensionare la potenza di questi ultimi del 20% per coprire queste perdite.

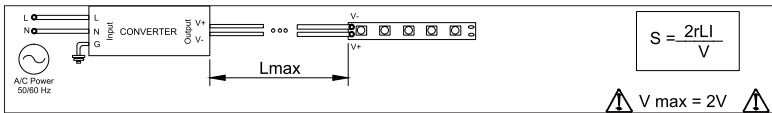

## AVERTISSEMENT AVVERTENZA



Conformément à la loi sur la protection des consommateurs, NOVOLUX LIGHTING garantit les produits acquis contre éventuels vices cachés ou défauts de fabrication d'origine. Leur durabilité dépendra toujours des points suivants :























1. Ne jamais utiliser de tournevis mécaniques sur les encastrables au sol. Risque de rupture ou de couple incorrect sur les vis.
2. Utiliser toujours le câble recommandé par le fabricant ou de qualité supérieure lors de l'installation. Ne jamais laisser ces câbles exposés ou non protégés pour éviter des dommages importants ou des problèmes potentiels d'humidité ou de capillarité.
3. Toute substitution de toute pièce d'origine fournie par le fabricant (y compris la visserie) annule automatiquement la garantie.
4. L'utilisation de silicone dégage Novolux de toute responsabilité.
5. Toute manipulation non autorisée par du personnel qualifié annule automatiquement la garantie.
6. Une utilisation incorrecte du raccord (presse-étoupe) annule automatiquement la garantie.
7. Novolux rappelle à ses clients que l'installation de son matériel dans des lieux publics relève de la responsabilité du prescripteur ou de l'installateur, car Novolux ne vend exclusivement que des éclairages d'intérieur et d'extérieur résidentiels.
8. La sélection du matériel par les clients décharge Novolux de toute application incorrecte de celui-ci.
9. Novolux ne sera responsable que de la qualité de ses produits, à condition de suivre les recommandations indiquées, et déclinera toute responsabilité pour : l'application inappropriée des luminaires ou des lampes utilisées, l'alimentation électrique incorrecte, le non-respect des instructions d'installation et d'entretien ou d'autres agents externes.
10. Les frais engagés dans la résolution d'un problème indépendant de la qualité du luminaire (déplacements du technicien, réparation des luminaires, etc.) seront facturés au client.

In ottemperanza alla legge per la difesa dei consumatori, NOVOLUX LIGHTING garantisce i prodotti acquistati da eventuali difetti nascosti o difetti di fabbricazione originali. La loro durabilità dipenderà sempre dai seguenti punti:

1. Non utilizzare in nessun caso cacciaviti meccanici su apparecchi a incasso a pavimento. Possibile rottura o una coppia errata nelle viti.
2. Utilizzare sempre nell'installazione il cavo raccomandato dal produttore o di qualità superiore. Mai lasciare esposti tali cavi o senza protezione per evitare danni maggiori o possibili problemi di umidità o capillarità.
3. Qualsiasi sostituzione di qualsiasi pezzo originale fornito dal produttore (comprese le viti) annulla automaticamente la garanzia.
4. L'uso del silicone esonera Novolux da ogni responsabilità.
5. Qualsiasi manipolazione non autorizzata e da parte di personale qualificato annulla automaticamente la garanzia.
6. Un uso improprio del raccordo (presa stagna) annulla automaticamente la garanzia.
7. Novolux ricorda ai suoi clienti che l'installazione del suo materiale in luoghi di affluenza pubblica è responsabilità del progettista o dell'installatore, poiché Novolux vende esclusivamente illuminazione per interni ed esterni residenziali.
8. La selezione del materiale da parte dei clienti esonera Novolux da una possibile applicazione scorretta dello stesso.
9. Novolux si responsabilizzerà solo della qualità dei suoi prodotti, a condizione che vengano seguite le raccomandazioni indicate, e declinerà ogni responsabilità per: l'applicazione impropria dei dispositivi di illuminazione o delle lampade utilizzate, l'alimentazione elettrica non corretta, la mancata osservanza delle istruzioni di installazione e manutenzione o altri agenti esterni.
10. Le spese sostenute nella risoluzione di un problema indipendente dalla qualità dell'apparecchio di illuminazione (spostamenti del tecnico, riparazione degli apparecchi di illuminazione, ecc.) saranno addebitate al cliente.

# PICTOGRAMME PITTOGRAMMA

ICÔNES GÉNÉRIQUES	ICONOGRAFIA GENERICA	
 N	Nouveauté	Novità
 N	Élargissement de gamme	Espansione di gamma
	Filtre à légumes	Filtro per verdure
	Filtre à poisson	Filtro per pesce
	Filtre à fruits de mer	Filtro per frutti di mare
	Filtre à pain	Filtro per il pane
	Filtre à viande	Filtro per carne
	Filtre de mode	Filtro di moda
	Dimensions d'encastrement (mm)	Misure di incasso (mm)

APPLICATIONS	APPLICAZIONI	
	Luminaire en applique murale	Luminaria da parete a superficie
	Luminaire encastré au plafond	Luminaria a soffitto a incasso
	Luminaire encastré au sol	Luminaria da incasso a pavimento
	Luminaire encastré mural	Luminaria a incasso a parete
	Luminaire encastré au plafond	Luminaria a incasso a soffitto
	Luminaire encastré au sol	Luminaria a incasso a pavimento
	Luminaire suspendu	Luminaria a sospensione
	Luminaire sur pied	Luminaria da terra
	Luminaire de table	Luminaria da tavolo
	Borne lumineuse ou luminaire de mur	Faro o luminaria da parete
	Luminaire de colonne	Luminaria a colonna
	Projecteur mural	Proiettore da parete
	Projecteur au sol	Proiettore a pavimento
	Projecteur de plafond	Proiettore a soffitto
	Projecteur encastré	Proiettore a incasso
	Luminaire suspendu sur rail	Luminaria a sospensione su binario
	Projecteur sur rail	Proiettore su binario
	Ventilateur avec lumière	Ventilatore con luce
	Ventilateur	Ventilatore
	Projecteur submersible	Luminaria sommergibile
	Luminaire submersible pour montage en surface sur un mur	Luminaria sommergibile per installazione a parete in superficie
	Luminaria sumergibile para emportar en pared	Recessed wall underwater luminaire







# PICTOGRAMME PITTOGRAMMA

## ICONOGRAPHIE TECHNIQUE

## ICONOGRAFIA TECNICA

### Alimentation

### Alimentazione

	Luminaire avec alimentation solaire	Luminaria con alimentazione solare
	Courant de la lampe en courant continu	Corrente della lampada in corrente continua
	Tension de la lampe en courant continu	Tensione della lampada in corrente continua
	Tension de la lampe en courant alternatif	Tensione della lampada in corrente alternata
	Fréquence	Frequenza
	Moteur à courant alternatif	Motore a corrente alternata
	Moteur à courant continu	Motore a corrente continua

### Équipe

### Squadra

	Équipement électronique inclus / Non inclus	Apparecchiatura elettronica inclusa / Non inclusa
---	---	---

### Dimérisation

### Dimerizzazione

	Régulation par coupure de fin de phase	Regolazione tramite interruzione alla fine della fase
	Régulation par coupure au début et/ou à la fin de la phase	Regolazione tramite interruzione all'inizio e/o alla fine della fase
	Réglable via le protocole DMX	Regolabile tramite protocollo DMX
	Graduable par poussoir	Dimmerable tramite pulsante
	Graduable par protocole 1-10V	Dimmerable tramite protocole 1-10V
	Contrôle d'éclairage sans fil CASAMBI	Controllo dell'illuminazione wireless CASAMBI
	Graduable via le protocole DALI	Dimmerable tramite protocole DALI

### Classe

### Class

	Classe I; Luminaire équipé de dispositifs de mise à la terre	Classe I; Luminaria dotata di dispositivi di messa a terra
	Classe II; Luminaire isolant doublement les parties sous tension et ne nécessitant pas de dispositifs de mise à la terre	Classe II; Luminaria che isola doppiamente le parti sotto tensione e non richiede dispositivi di messa a terra
	Classe III; Luminaire alimenté à très basse tension et ne devant pas avoir de dispositifs de mise à la terre	Classe III; Luminaria alimentata a tensione molto bassa e che non deve avere dispositivi di messa a terra

# PICTOGRAMME PITTOGRAMMA

## Indice de Protection IP (IP Code)



Selon la norme EN 60598-1, les luminaires sont classés en fonction de la protection dérivée de leurs éléments, symbolisée par les lettres IP suivies de trois chiffres, bien que seules les deux premières soient affichées.

1ère chiffre : Indique la protection du matériau contre l'entrée d'objets solides externes, ainsi que la protection des personnes par rapport à la tension des composants du luminaire.

- 0- Non protégé
- 1- > 50 mm de diamètre
- 2- > 12,5 mm de diamètre
- 3- > 2,5 mm de diamètre
- 4- > 1,0 mm de diamètre
- 5- : Protégé contre la poussière
- 6- : Hermétique à la poussière

2ème chiffre : Indique la protection contre l'entrée d'eau avec des effets néfastes.

- 0- (non protégé)
- 1- Goutte à goutte verticalement
- 2- Goutte à goutte (inclinaison de 15°)
- 3- Pulvérisation
- 4- Éclaboussures
- 5- Égouttement
- 6- Jet puissant
- 7- Immersion temporaire
- 8- Immersion continue

## Grado di protezione IP

Secondo la normativa EN 60598-1, i corpi illuminanti sono classificati in base alla protezione derivante dai loro elementi, simboleggiata dalle lettere IP seguite da tre cifre, anche se vengono mostrate solo le prime due.

1ª cifra: Indica la protezione del materiale contro l'ingresso di oggetti solidi esterni, nonché la protezione delle persone rispetto alla tensione dei componenti del corpo illuminante.

- 0- Non protetto
- 1- > 50 mm di diametro
- 2- > 12,5 mm di diametro
- 3- > 2,5 mm di diametro
- 4- > 1,0 mm di diametro
- 5- Protetto dalla polvere
- 6- Ermetico alla polvere

2ª cifra: Indica la protezione contro l'ingresso di acqua con effetti dannosi.

- 0- (non protetto)
- 1- Gocciolamento verticale
- 2- Gocciolamento (inclinato di 15°)
- 3- Spruzzatura
- 4- Schizzi
- 5- Gocciolamento
- 6- Getto potente
- 7- Immersione temporanea
- 8- Immersione continua

## Grado de protección IK



Code IK  
Système de codification indiquant le degré de protection fourni par une enveloppe contre les impacts mécaniques nocifs. Energie d'impact (J)

## Degree of IK protection

Codice IK  
Sistema di codifica per indicare il grado di protezione fornito da un involucro contro gli impatti meccanici nocivi. Energia d'impatto (J)

IK01	IK02	IK03	IK04	IK05	IK06	IK07	IK08	IK09	IK10
0,15	0,2	0,35	0,5	0,7	1	2	5	10	20

## Vie

## Vita



Durée de vie (heures)

Durata utile (ore)



Maintien du flux lumineux des LED

Manutenzione del flusso luminoso dei LED



Luminaire rechargeable

Luminaria ricaricabile



Autonomie de la batterie (heures)

Autonomia della batteria (ore)



Temps de charge complet (heures)

Tempo di ricarica completa (ore)







# PICTOGRAMME PITTOGRAMMA

 Faisceau lumineux	Fascio di luce
 Émission de lumière directe ou indirecte	Emissione di luce diretta o indiretta
 Émission de lumière directe et indirecte	Emissione di luce diretta e indiretta
 Émission de lumière périphérique	Emissione di luce periferica
 Émission de lumière asymétrique	Emissione di luce asimmetrica
 Émission de lumière multiple	Multi-emissione di luce
 Angle d'émission de lumière	Angolo di emissione della luce
 Flux vers l'hémisphère supérieur	Flusso verso l'emisfero superiore
 UGR < xx	Indice di abbagliamento unificato



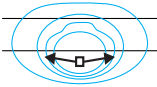
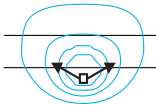
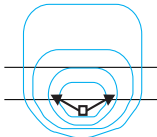
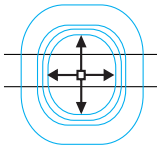

## Types de distribution de l'éclairage pour l'éclairage extérieur de la zone exterior

Tipi di distribuzione luminosa per l'illuminazione esterna della zona











 Type II	 Type II	 Type III	 Type IV
			







CRI > xx	Indice de rendu des couleurs	CRI	Indice di resa cromatica







 STEP	Consistance de la couleur	Passo	Coerenza del colore



 xxxKg	Résistance	Resistenza
 xxxKg	Luminaire adapté pour la circulation non roulante	Luminaria adatta per il transito non veicolare
 xxxKg	Luminaire adapté à la circulation routière	Luminaria adatta per il transito veicolare
	Luminaire avec une excellente résistance à la corrosion (aluminium avec double revêtement de peinture, acier avec processus de galvanisation, résine ou polyamide)	Luminaria con un'eccellente resistenza alla corrosione (alluminio con doppio rivestimento di vernice, acciaio con processo di zincatura, resina o poliammide)
	Température maximale de la surface du luminaire (°C)	Temperatura massima della superficie della luminaria (°C)

# PICTOGRAMME PITTOGRAMMA





Fonctionnalités	Funzionalità
 Luminaire avec option de sélection de la température de couleur	Luminaria con opzione di selezione della temperatura del colore
 Luminaire avec option de sélection de la puissance	Luminaria con opzione di selezione della potenza
 Dimmable	Dimmerabile
 Angle maximum d'inclinaison de la luminaire	Angolo massimo di basculamento della luminaria
 Angle de rotation maximal	Angolo di rotazione massimo
 Luminaire avec détecteur de mouvement	Luminaria con sensore di movimento
 Luminaire avec capteur crépusculaire	Luminaria con sensore crepuscolare
 Luminaire avec capteur crépusculaire subordonné à la détection de mouvement	Luminaria con sensore crepuscolare subordinato alla rilevazione del movimento
 Luminaire avec éclairage de secours	Luminaria con luce di emergenza
 Luminaire avec connexion USB (5V max, 2A)	Luminaria con connessione USB (5V max, 2A)
 Fonction inverse pour une utilisation toute l'année	Funzione inversa per un utilizzo tutto l'anno





Équipement pour installation	Attrezzatura per l'installazione
 Luminaire avec une sortie de câble	Lumino con un'uscita di cavo
 Luminaire avec deux sorties de câble	Luminaria con due uscite di cavo
 Longueur en mètres de câble conducteur fourni	Lunghezza in metri di cavo conduttore fornito
 Luminaire avec câble et fiche intégrés	Luminaria con cavo e spina incorporati
 Luminaire avec prise électrique IP44	Luminaria con presa di corrente IP44
 Luminaire avec interrupteur intégré	Luminaria con interruttore incorporato
 Nombre de pales du ventilateur	Numero di pale del ventilatore



Caractéristiques d'installation	Caratteristiche di installazione
 Boîtier encastré inclus	Scatola da incasso inclusa
 Nécessite de drainage	Necessita di drenaggio
 Ancrage inclus	Ancoraggio incluso
 Installer sur un pilier à un niveau supérieur	Installare su una pilastra a un livello superiore
 Ne pas utiliser de tournevis mécaniques en aucun cas	Non utilizzare in nessun caso cacciaviti meccanici
 Adapté au bord de la mer	Adatto al mare







Classique	Classico
 Globe avec fermeture à baïonnette	Globo con chiusura a baionetta
 Globe avec fermeture hermétique	Globo con chiusura ermetica
 Poteau avec registre	Palo con registro

# PICTOGRAMME PITTOGRAMMA

Entretien	Manutenzione
 Luminaire en acier inoxydable nécessitant un entretien périodique	Luminaria in acciaio inossidabile che richiede manutenzione periodica
 Luminaire en laiton nécessitant un entretien périodique avec un poli spécifique pour retrouver l'éclat	Luminaria in ottone che richiede manutenzione periodica con una lucidatura specifica per recuperare la lucentezza
 Luminaire ou poteau en résine nécessitant un entretien périodique avec de l'huile synthétique pour retrouver l'éclat	Luminaria o palo in resina che richiede manutenzione periodica con olio sintetico per recuperare la lucentezza
 Luminaire en acier inoxydable nécessitant un entretien périodique	Luminaria in acciaio inossidabile che richiede manutenzione periodica
 Possibilité d'appliquer des finitions spéciales	Possibilità di applicare finiture speciali

Bandes LED	Strisce LED
 XXm Longueur de la bande LED (unité de vente minimale)	Lunghezza della striscia LED (unità minima di vendita)
 XXXmm Longueur minimale de coupe	Lunghezza minima di taglio
 Incorporer un ruban adhésif 3M au dos	Incorpora nastro biadesivo 3M sul retro
 2.4GHz Connecter au réseau WiFi sur la bande de fréquence 2,4 GHz	Connettersi alla rete WiFi sulla banda 2,4 GHz

Immersibles	Sommergibili
 Non adapté aux piscines	Non adatto per piscine
 XX Nombre de couleurs	Numero di colori
Nombre de séquences de changement de couleur	Numero di sequenze di cambio colore

Accessoires	Accessori
 Luminaire avec lampe incluse	Luminaria con lampada inclusa
 Luminaire sans lampe incluse	Luminaria senza lampada inclusa
 Écran non inclus	Schermo non incluso
 Chargement sans fil pour appareils mobiles	Ricarica wireless per dispositivi mobili
 Comprend une télécommande	Include telecomando
 Luminaire avec emballage d'entreprise	Luminaria con confezione aziendale

**CONDITIONS GÉNÉRALES DE VENTE (FRANCE)**

Pour toutes livraisons en France métropolitaine, Corse et Dom-Tom, il convient de consulter nos services commerciaux: [france@novoluxlighting.com](mailto:france@novoluxlighting.com)

**CONDIZIONI GENERALI DI VENDITA (ITALIA)**

Per tutti gli ordini in Italia, si prega di contattare il nostro ufficio vendite: [export@novoluxlighting.com](mailto:export@novoluxlighting.com)

**CONDIÇÕES GERAIS DE VENDA (PORTUGAL)**

Para todas as entregas em Portugal, por favor contacte o nosso departamento de vendas: [info@novoluxlighting.com](mailto:info@novoluxlighting.com)

**GENERAL CONDITIONS OF SALES (EXPORT) – CONDITIONS GÉNÉRALES DE VENTE (EXPORT) – CONDICIONES GENERALES DE VENTA EXPORT**

For all export deliveries, please contact our sales department: [export@novoluxlighting.com](mailto:export@novoluxlighting.com)

## CONDICIONES GENERALES DE VENTA (ESPAÑA, ANDORRA Y PORTUGAL)

Todos los pedidos cursados a Novolux Lighting, S.L. en adelante "NOVOLUX", implican la aceptación íntegra, por parte del comprador, de las presentes Condiciones Generales de Venta, salvo acuerdos de colaboración y condiciones particulares pactadas.

### 1. Precios

Todos los pedidos tanto en Oferta Comercial Estándar y Bajo Pedido (con referencia en catálogo) se aplicará la tarifa y condiciones comerciales vigentes a la fecha de recepción/aceptación de dicho pedido. Para aquellos pedidos de Servicios Especiales (referencia fuera de catálogo), será necesario ir acompañado de la oferta por escrito de NOVOLUX con el compromiso de aceptación, sin opción a devolución una vez iniciado el proceso de fabricación. Sólo serán válidos los precios especiales de las ofertas, sobre los pedidos íntegros de los mismos. Cualquier alteración sobre la oferta íntegra original por parte del cliente, puede suponer una revisión de las condiciones iniciales de la venta.

### 2. Gestión Pedidos

Un pedido no se aceptado/procesara, hasta que la totalidad de este se haya cursado correctamente (referencia, color, accesorios, P.V.P. etc.). La tramitación de un pedido a NOVOLUX expresara la voluntad de compra por parte del cliente. En el caso que el pedido no pueda ser servido, por cualquier motivo, NOVOLUX informará al cliente de dicha imposibilidad en la mayor brevedad posible. Los pedidos con precios erróneos o discrepancias con las condiciones registradas y/o acordadas por NOVOLUX, no serán tramitados a la espera de una aceptación por ambas partes. El correo (e-mail) al cual NOVOLUX solicitará dicha confirmación y aceptación será el que se indique en el pedido recibido del cliente. Cualquier Pedido recibido que incluya referencias que soliciten Ejecuciones Especiales y/o Bajo Pedido es necesario el requerimiento por parte de NOVOLUX, para la confirmación tanto en factibilidad de producción, precio y plazo de entrega antes de su tramitación. NOVOLUX solicitará el pago por anticipado no inferior al 30% del valor del pedido (impuestos incluidos). Los pedidos gestionados que no autoricen la entrega parcial, será servido el material disponible en stock y los portes tendrán la misma condición que el pedido original, entregando los restos de pedido a portes pagados si el pedido ya cumplía la condición inicialmente. Aquellos pedidos en los que no se indique la voluntad expresa del cumplimiento de un plazo de entrega, serán gestionados según se expone en el punto anterior. En el caso que el cumplimiento del plazo de entrega del pedido total o parcialmente sea requisito indispensable para el cliente, este deberá solicitar plazo de entrega por escrito a NOVOLUX.

### 3. Devoluciones

Toda devolución debe ser autorizada previamente por NOVOLUX, dicha devolución tendrá que ir acompañada del número de autorización suministrado por el departamento de incidencias. ([incidencias@novoluxlighting.com](mailto:incidencias@novoluxlighting.com)), sin dicho número no se aceptará la mercancía en el almacén de NOVOLUX. Los productos de Ejecuciones Especiales, Bajo Pedido o descatalogados no se aceptará su devolución, ni aun proponiendo una depreciación. Los productos que sean objeto de solicitud de devolución deben haber sido facturados dentro de los 60 días anteriores a la venta. En caso de incumplimiento de dicha condición, se informará al cliente de su negativa aceptación por NOVOLUX. No se aceptarán devoluciones de productos que no estén en perfecto estado para la venta, incluido su embalaje original. Si por esta causa el cliente solicita el retorno de la mercancía devuelta, el envío de retorno será a portes debidos. El plazo de devolución del material a NOVOLUX, una vez autorizada, será de máximo 60 días. A todo producto devuelto se le aplicará la siguiente depreciación sin excepción:

1. Solicitud hasta 30 días posteriores a la fecha de factura... 10% de depreciación sobre el valor de la devolución, con un mínimo de 20€ por gastos de gestión.
2. Solicitud hasta 60 días posteriores a la fecha de factura... 15% de depreciación sobre el valor de la devolución, con un mínimo de 30€ por gastos de gestión.

No se aceptará ningún material de devolución enviado a portes debidos.

Todo material devuelto no autorizado, en malas condiciones o sin autorización, se informará al cliente de la obligación de retirarlo de NOVOLUX en un periodo inferior a 15 días, de su notificación, transcurrido dicho tiempo, se considerará material abandonado y se procederá a su destrucción.

### 4. Entregas / Transportes

Para envíos internacionales, las mercancías viajarán por cuenta y riesgo del comprador en condiciones franco fábrica (EXWORKS). Salvo que se acuerden otros términos en ambas compañías. Los pedidos de importes inferiores a los pactados por zona de venta (consulte importe de su zona) y el servicio será a portes pagados, estos irán cargados en factura. Toda incidencia, rotura o falta de material tiene que ir anotada en el albarán de entrega del transportista, la falta de dicha información exime de responsabilidad tanto al transportista como a NOVOLUX.

# CONDICIONES GENERALES DE VENTA (ESPAÑA, ANDORRA Y PORTUGAL)

No se admitirán reclamaciones por roturas, incidencias o falta de material durante el transporte transcurridas 72 horas desde de la recepción de la mercancía. NOVOLUX se responsabilizará de las incidencias en la entrega, cuando envíe mercancías a portes pagados (a cargo de NOVOLUX). Los riesgos concernientes a la devolución de las mercancías no autorizada por NOVOLUX irá bajo la responsabilidad del comprador.

## 5. Plazos de disponibilidad (franco fábrica)

Los plazos de disponibilidad de mercancía dados por NOVOLUX son siempre aproximados y pueden estar sujetos a variaciones debidas a los propios procesos de gestión de los pedidos, producciones, o a terceros responsables como el transporte de mercancías y/o suministro de componentes. Las posibles variaciones en los plazos, en ningún caso suponen aceptación de responsabilidad y la posible penalización por demora por parte de NOVOLUX.

## 6. Servicio especial CRISTHER 1 hora (incluyendo todas las marcas: CRISTHER, DOPO, EXO, INDELUX)

Nuestro servicio especial garantiza la preparación del pedido y su puesta a disposición del transitario o transportista designado, en nuestros almacenes en el plazo de 1 hora. En este servicio los artículos tendrán un cargo de +6%. Los tiempos de transporte no son responsabilidad de NOVOLUX.

## 7. Proyectos de iluminación

Como servicio adicional a nuestros clientes, disponemos de nuestro propio Departamento Técnico de Proyectos, donde ponemos a su disposición, para consultar cualquier necesidad luminica de interior y exterior. Nuestro departamento técnico de proyectos se adapta y cubre las necesidades necesarias para cualquier proyecto. El departamento de proyectos se reserva el derecho de indicar el coste de algunos proyectos de especial relevancia a bonificar del pedido de compra final del material en nuestra empresa.

## 8. Muestras

Las muestras de material deberán ser solicitadas mediante pedido y serán facturadas. El plazo de devolución de las muestras a NOVOLUX, será de un máximo de 30 días desde la fecha de entrega y se devolverán a portes pagados por parte del cliente. Las muestras devueltas que no estén en condiciones para la venta (en perfecto estado y con su embalaje original), no serán abonadas.

## 9. Calidad

Los productos suministrados por NOVOLUX, cumplen con la directiva RoHS 2002/95/CE y con la Norma Europea que marcan las directivas 2006/95/CE indicándose de forma visible tanto en el producto como en su caja exterior. Además, de haber sido sometidos a rigurosos controles de calidad que garantizan su correcto funcionamiento. NOVOLUX, trabaja con el objetivo de una mejora continua y adecuar sus productos al mercado actual como a los cumplimientos de las normativas vigentes. Por ello, nos reservamos el derecho a modificar, suprimir o ampliar nuestros productos en catalogo sin previo aviso, y sin que ello sea motivo de

reclamaciones. Dependiendo de los materiales de fabricación y para su máxima optimización en el tiempo, NOVOLUX recomienda el uso de las instrucciones adjuntas en los materiales, como realizar los trabajos de mantenimiento con la periodicidad necesaria.

## 10. Garantía

Todos los productos de NOVOLUX, poseen de un periodo de garantía de 3 años desde la fecha de factura de NOVOLUX. Toda reparación del producto de NOVOLUX reparado por nuestros técnicos, automáticamente obtiene la garantía de 6 meses de la pieza reparada o sustituida. Bajo solicitud, se puede valorar una extensión de garantía u ofrecer una garantía de proyecto personalizada, tras evaluar las condiciones de aplicación.

En el caso de las lámparas, se garantizarán 6 meses al considerarse un consumible, siempre que se cumplan las siguientes condiciones de aplicación:

- Temperatura ambiente de máx. -10°C a +40°C.
- Min. 10mm de espacio alrededor del cuerpo de la lámpara.
- La instalación eléctrica en la que funcione el producto no debe estar sometida a fluctuaciones de tensión dentro de un intervalo que sobrepase el nominal de la red +/- 10%.
- Máx. 50.000 conmutaciones rápidas (tiempo entre encendido y apagado inferior a 30s).

En caso de no cumplirse estas condiciones, se aplicará la garantía legal de 6 meses contra defectos de fabricación. El Departamento Técnico de NOVOLUX es el único autorizado para determinar, tras su análisis, si se trata de un defecto de fabricación, después de recibir por escrito la incidencia al igual que las fotografías del equipo y ubicación de donde está instalado, también se exigirá la factura de venta para verificar la fecha. La responsabilidad de NOVOLUX cubre la sustitución del producto defectuoso, por el mismo modelo u otro similar, o el abono de su valor en caso de que ya no se fabrique o no se encuentre disponible. No le será exigible ninguna otra responsabilidad por garantía o cualquier otro concepto, explícita o implícita, salvo la aquí establecida. En ningún caso NOVOLUX atenderá los trabajos de sustitución o renovación de los materiales que estén en garantía. Esta condición es aceptada a la compra de nuestros productos. NOVOLUX no asume la responsabilidad por la mala utilización y/o aplicación de sus productos. Nuestros productos perderán su garantía en caso de que sean manipulados indebidamente o instalados incorrectamente. Quedan excluidos de la garantía los defectos y deterioros causados por el desgaste o uso, por causa de fuerza mayor, mantenimiento defectuoso, o por el uso inadecuado del producto no especificado ni autorizado previamente por el vendedor. Las intervenciones a título de garantía no tendrán como efecto la prolongación de la duración de esta. No le será responsable de los inconvenientes derivados por las posibles erratas en las fotografías, medidas y/o datos que aparecen impresos en catálogo.

## 11. Reserva de propiedad

NOVOLUX se reserva el derecho de propiedad de todos los materiales que suministre, hasta que el comprador haya hecho efectivo el pago total de los mismos.

## 12. Jurisdicción

Para cualquier discrepancia o litigio que se derive de las citadas Condiciones Generales de Venta, ambas partes se someten a la competencia de los Juzgados y Tribunales de Barcelona, con expresa renuncia a su fuero propio.

REF.	FAM.	BRAND	PAG.
003A-G05X1A-30	ABREGO	DOPO	476
003B-G05X1A-30	ABREGO	DOPO	559
007A-G05X1A-01	ALBA	CRISTHER	665
007A-G05X1A-02	ALBA	CRISTHER	665
007B-G05X1A-01	ALBA	CRISTHER	665
007B-G05X1A-02	ALBA	CRISTHER	665
018A-L0107B-30	ARGIN	CRISTHER	668
018A-L0207B-30	ARGIN	CRISTHER	668
025C-L3106B10-02	BAMBOLA	CRISTHER	714
025C-L3106B30-02	BAMBOLA	CRISTHER	714
025C-L3306B10-02	BAMBOLA	CRISTHER	714
025C-L3306B30-02	BAMBOLA	CRISTHER	714
030A-L0316D-01	BELT	CRISTHER	778
030A-L0427D-01	BELT	CRISTHER	778
036A-G05X1A-01	BOOM	DOPO	588
036A-G05X1A-02	BOOM	DOPO	588
036B-G05X1A-01	BOOM	DOPO	588
036B-G05X1A-02	BOOM	DOPO	588
036D-G05X1A-01	BOOM	DOPO	589
036D-G05X1A-02	BOOM	DOPO	589
036E-G05X1A-01	BOOM	DOPO	589
036E-G05X1A-02	BOOM	DOPO	589
036F-G05X1A-01	BOOM	DOPO	589
036F-G05X1A-02	BOOM	DOPO	589
037A-G21X1A-30	BORA	DOPO	507
037A-L02D1A-30	BORA LED	DOPO	507
037B-G21X1A-30	BORA	DOPO	507
037D-G21X1A-30	BORA	DOPO	507
046C-G05X1A-01	CAST	DOPO	590
046C-G05X1A-02	CAST	DOPO	590
046E-G05X1A-01	CAST	DOPO	590
046E-G05X1A-02	CAST	DOPO	590
046G-G05X1A-01	CAST	DOPO	590
046G-G05X1A-02	CAST	DOPO	590
051A-G05X1A-04	CICLON	DOPO	469
051B-G05X1A-04	CICLON	DOPO	469
056B-G05X1A-02	CITY INDURA	DOPO	615
056D-G05X1A-02	CITY INDURA	DOPO	615
057B-G05X1A-02	INDURA GLOBO	DOPO	592
057D-G05X1A-02	INDURA GLOBO	DOPO	595
057E-G05X1A-02	INDURA GLOBO	DOPO	595
057F-G05X1A-02	INDURA GLOBO	DOPO	595
059A-G05X1A-01	CLIC-CLAC 4	DOPO	612
059A-G05X1A-02	CLIC-CLAC 4	DOPO	612
059B-G05X1A-01	CLIC-CLAC 4	DOPO	613
059B-G05X1A-02	CLIC-CLAC 4	DOPO	613
059C-G05X1A-01	CLIC-CLAC 4	DOPO	613
059C-G05X1A-02	CLIC-CLAC 4	DOPO	613
059G-G05X1A-01	CLIC-CLAC 4	DOPO	612
059G-G05X1A-02	CLIC-CLAC 4	DOPO	612
059H-G05X1A-01	CLIC-CLAC 4	DOPO	612
059H-G05X1A-02	CLIC-CLAC 4	DOPO	612
059I-G05X1A-01	CLIC-CLAC 4	DOPO	612
059I-G05X1A-02	CLIC-CLAC 4	DOPO	612
059J-G05X1A-01	CLIC-CLAC 4	DOPO	613
059J-G05X1A-02	CLIC-CLAC 4	DOPO	613
060A-G05X1A-01	CLIC-CLAC 6	DOPO	624
060A-G05X1A-02	CLIC-CLAC 6	DOPO	624
060B-G05X1A-01	CLIC-CLAC 6	DOPO	624
060B-G05X1A-02	CLIC-CLAC 6	DOPO	624
060D-G05X1A-01	CLIC-CLAC 6	DOPO	625
060D-G05X1A-02	CLIC-CLAC 6	DOPO	625

REF.	FAM.	BRAND	PAG.
060E-G05X1A-01	CLIC-CLAC 6	DOPO	625
060E-G05X1A-02	CLIC-CLAC 6	DOPO	625
060G-G05X1A-01	CLIC-CLAC 6	DOPO	624
060G-G05X1A-02	CLIC-CLAC 6	DOPO	624
060H-G05X1A-01	CLIC-CLAC 6	DOPO	624
060H-G05X1A-02	CLIC-CLAC 6	DOPO	624
060J-G05X1A-01	CLIC-CLAC 6	DOPO	625
060J-G05X1A-02	CLIC-CLAC 6	DOPO	625
061B-G05X1A-01	CLIC-CLAC GLOBO	DOPO	598
061B-G05X1A-02	CLIC-CLAC GLOBO	DOPO	598
061D-G05X1A-01	CLIC-CLAC GLOBO	DOPO	599
061D-G05X1A-02	CLIC-CLAC GLOBO	DOPO	599
061E-G05X1A-01	CLIC-CLAC GLOBO	DOPO	599
061E-G05X1A-02	CLIC-CLAC GLOBO	DOPO	599
061G-G05X1A-01	CLIC-CLAC GLOBO	DOPO	598
061G-G05X1A-02	CLIC-CLAC GLOBO	DOPO	598
061H-G05X1A-01	CLIC-CLAC GLOBO	DOPO	598
061H-G05X1A-02	CLIC-CLAC GLOBO	DOPO	598
061I-G05X1A-01	CLIC-CLAC GLOBO	DOPO	598
061I-G05X1A-02	CLIC-CLAC GLOBO	DOPO	598
061J-G05X1A-01	CLIC-CLAC GLOBO	DOPO	599
061J-G05X1A-02	CLIC-CLAC GLOBO	DOPO	599
063A-G05X1A-01	COC	CRISTHER	666
063A-G05X1A-02	COC	CRISTHER	666
063B-G05X1A-01	COC	CRISTHER	666
063B-G05X1A-02	COC	CRISTHER	666
068A-G05X1A-02	COK	CRISTHER	751
068A-G05X1A-04	COK	CRISTHER	751
068B-G05X1A-02	COK	CRISTHER	751
068B-G05X1A-04	COK	CRISTHER	751
068C-G05X1A-02	COK	CRISTHER	751
068C-G05X1A-04	COK	CRISTHER	751
068D-G05X1A-02	COK	CRISTHER	751
068D-G05X1A-04	COK	CRISTHER	751
077A-L0304D-01	CUP	CRISTHER	780
077A-L0404D-01	CUP	CRISTHER	780
077B-L0304D-01	CUP	CRISTHER	780
077B-L0404D-01	CUP	CRISTHER	780
084A-G31X1A-01	DEVON	DOPO	491
084A-G31X1A-02	DEVON	DOPO	491
084A-G31X1A-03	DEVON	DOPO	491
084A-G31X2A-01	DEVON	DOPO	491
084A-G31X2A-02	DEVON	DOPO	491
084A-G31X2A-03	DEVON	DOPO	491
084B-G31X2A-02	DEVON	DOPO	493
084B-G31X2A-03	DEVON	DOPO	493
084C-G31X1A-01	DEVON	DOPO	492
084C-G31X1A-03	DEVON	DOPO	492
084C-G31X2A-01	DEVON	DOPO	492
084C-G31X2A-02	DEVON	DOPO	492
084C-G31X2A-03	DEVON	DOPO	492
084D-G31X1A-02	DEVON	DOPO	493
084D-G31X1A-03	DEVON	DOPO	493
084F-G31X1A-02	DEVON	DOPO	493
084F-G31X1A-03	DEVON	DOPO	493
084G-G31X1A-01	DEVON	DOPO	491
084G-G31X1A-02	DEVON	DOPO	491
084G-G31X1A-03	DEVON	DOPO	491
084I-G31X1A-01	DEVON	DOPO	492
084I-G31X1A-02	DEVON	DOPO	492
084I-G31X1A-03	DEVON	DOPO	492
084K-G31X1A-02	DEVON	DOPO	490

REF.	FAM.	BRAND	PAG.	REF.	FAM.	BRAND	PAG.
084K-G31X1A-03	DEVON	DOPO	490	113A-L2305B-02	FOCUS	CRISTHER	786
084Q-G31X1A-02	DEVON	DOPO	490	113A-L2305D-02	FOCUS	CRISTHER	786
084Q-G31X1A-03	DEVON	DOPO	490	113B-L2305B-02	FOCUS	CRISTHER	787
084U-G31X2A-01	DEVON	DOPO	490	114A-G05X1A-02	FRAM	CRISTHER	752
084U-G31X2A-02	DEVON	DOPO	490	114A-G05X1A-03	FRAM	CRISTHER	752
084U-G31X2A-03	DEVON	DOPO	490	117B-G05X1A-30	GALERNA	DOPO	559
096A-G04X1A-01	ELITE 6	DOPO	626	117C-G05X1A-30	GALERNA	DOPO	476
096A-G04X1A-02	ELITE 6	DOPO	626	118B-L0358D-30	GAMBLE-MAXI	CRISTHER	784
096B-G05X1A-01	ELITE 6	DOPO	627	118B-L0448D-30	GAMBLE-MAXI	CRISTHER	784
096B-G05X1A-02	ELITE 6	DOPO	627	127G-G05X1A-01	GLOBI	DOPO	597
096C-G05X1A-01	ELITE 6	DOPO	627	127G-G05X1A-02	GLOBI	DOPO	597
096C-G05X1A-02	ELITE 6	DOPO	627	127K-G05X1A-01	GLOBI	DOPO	597
096D-G05X1A-01	ELITE 6	DOPO	626	127K-G05X1A-02	GLOBI	DOPO	597
096D-G05X1A-02	ELITE 6	DOPO	626	129E-G05X1A-02	GLOU	DOPO	580
096E-G05X1A-01	ELITE 6	DOPO	626	129F-G05X1A-02	GLOU	DOPO	580
096E-G05X1A-02	ELITE 6	DOPO	626	129G-G05X1A-02	GLOU	DOPO	580
096F-G05X1A-01	ELITE 6	DOPO	626	129H-G05X1A-02	GLOU	DOPO	580
096F-G05X1A-02	ELITE 6	DOPO	626	144B-G05X1A-02	INDURA BIG 6	DOPO	622
096G-G05X1A-01	ELITE 6	DOPO	626	144D-G05X1A-02	INDURA BIG 6	DOPO	623
096G-G05X1A-02	ELITE 6	DOPO	626	144E-G05X1A-02	INDURA BIG 6	DOPO	623
096H-G05X1A-01	ELITE 6	DOPO	626	144F-G05X1A-02	INDURA BIG 6	DOPO	623
096H-G05X1A-02	ELITE 6	DOPO	626	144G-G05X1A-02	INDURA BIG 6	DOPO	622
096I-G05X1A-01	ELITE 6	DOPO	626	145I-G05X1A-02	INDURA GLOBO	DOPO	593
096I-G05X1A-02	ELITE 6	DOPO	626	146B-G05X1A-02	INDURA MEDIUM 4	DOPO	616
096J-G05X1A-01	ELITE 6	DOPO	626	146D-G05X1A-02	INDURA MEDIUM 4	DOPO	616
096J-G05X1A-02	ELITE 6	DOPO	626	146D-G31X1A-02	INDURA MEDIUM 4	DOPO	616
096K-G05X1A-01	ELITE 6	DOPO	627	146E-G05X1A-02	INDURA MEDIUM 4	DOPO	616
096K-G05X1A-02	ELITE 6	DOPO	627	146E-G31X1A-02	INDURA MEDIUM 4	DOPO	616
096L-G05X1A-01	ELITE 6	DOPO	627	146H-G05X1A-02	INDURA MEDIUM 4	DOPO	616
096L-G05X1A-02	ELITE 6	DOPO	627	147A-G05X1A-02	INDURA MEDIUM 6	DOPO	620
096M-G05X1A-01	ELITE 6	DOPO	627	147B-G05X1A-02	INDURA MEDIUM 6	DOPO	620
096M-G05X1A-02	ELITE 6	DOPO	627	147D-G05X1A-02	INDURA MEDIUM 6	DOPO	621
096N-G05X1A-01	ELITE 6	DOPO	627	147E-G05X1A-02	INDURA MEDIUM 6	DOPO	621
096N-G05X1A-02	ELITE 6	DOPO	627	147F-G05X1A-02	INDURA MEDIUM 6	DOPO	621
096O-G05X1A-01	ELITE 6	DOPO	627	147H-G05X1A-02	INDURA MEDIUM 6	DOPO	620
096O-G05X1A-02	ELITE 6	DOPO	627	147I-G05X1A-02	INDURA MEDIUM 6	DOPO	620
096P-G05X1A-01	ELITE 6	DOPO	627	148D-G05X1A-02	INDURA GLOBO	DOPO	594
096P-G05X1A-02	ELITE 6	DOPO	627	148E-G05X1A-02	INDURA GLOBO	DOPO	594
096Q-G05X1A-01	ELITE 6	DOPO	628	148H-G05X1A-02	INDURA GLOBO	DOPO	593
096Q-G05X1A-02	ELITE 6	DOPO	628	149B-G05X1A-02	INDURA MINI 4	DOPO	618
096R-G05X1A-01	ELITE 6	DOPO	628	149G-G05X1A-02	INDURA MINI 4	DOPO	618
096R-G05X1A-02	ELITE 6	DOPO	628	149H-G05X1A-02	INDURA MINI 4	DOPO	618
096S-G05X1A-01	ELITE 6	DOPO	628	149I-G05X1A-02	INDURA MINI 4	DOPO	618
096S-G05X1A-02	ELITE 6	DOPO	628	150B-G05X1A-02	INDURA MINI 6	DOPO	619
096T-G05X1A-01	ELITE 6	DOPO	628	150G-G05X1A-02	INDURA MINI 6	DOPO	619
096T-G05X1A-02	ELITE 6	DOPO	628	150H-G05X1A-02	INDURA MINI 6	DOPO	619
096U-G05X1A-01	ELITE 6	DOPO	628	150I-G05X1A-02	INDURA MINI 6	DOPO	619
096U-G05X1A-02	ELITE 6	DOPO	628	151A-G05X1A-02	INDURA GLOBO	DOPO	592
096V-G05X1A-01	ELITE 6	DOPO	628	151D-G05X1A-02	INDURA GLOBO	DOPO	594
096V-G05X1A-02	ELITE 6	DOPO	628	151E-G05X1A-02	INDURA GLOBO	DOPO	594
107B-G05X1A-01	FAR	DOPO	486	151H-G05X1A-02	INDURA GLOBO	DOPO	593
107B-G05X1A-02	FAR	DOPO	486	151I-G05X1A-02	INDURA GLOBO	DOPO	593
107G-G05X1A-01	FAR	DOPO	486	152A-L02X1K-03	INTI	CRISTHER	706
107G-G05X1A-02	FAR	DOPO	486	152A-L07X1K-03	INTI	CRISTHER	706
107G-G05X1A-03	FAR	DOPO	486	152B-L02X1K-03	INTI	CRISTHER	706
107H-G05X1A-01	FAR	DOPO	486	152B-L07X1K-03	INTI	CRISTHER	706
107H-G05X1A-02	FAR	DOPO	486	152C-L02X1K-03	INTI	CRISTHER	706
107I-L0212B-01	FAR	DOPO	487	152C-L07X1K-03	INTI	CRISTHER	706
107I-L0212B-02	FAR	DOPO	487	152D-L02X1K-03	INTI	CRISTHER	706
107J-L0212B-01	FAR	DOPO	487	152D-L07X1K-03	INTI	CRISTHER	706
107J-L0212B-02	FAR	DOPO	487	157A-H20X1A-01	ISORA	CRISTHER	651
113A-L2105A-02	FOCUS	CRISTHER	685	157A-H20X1A-02	ISORA	CRISTHER	651

REF.	FAM.	BRAND	PAG.
157A-H20X1A-03	ISORA	CRISTHER	651
157A-H20X1A-04	ISORA	CRISTHER	651
157A-H20X1A-91	ISORA	CRISTHER	651
157A-L0105B-01	ISORA	CRISTHER	651
157A-L0105B-02	ISORA	CRISTHER	651
157A-L0105B-03	ISORA	CRISTHER	651
157A-L0105B-04	ISORA	CRISTHER	651
157A-L0105B-91	ISORA	CRISTHER	651
157A-L0205B-01	ISORA	CRISTHER	651
157A-L0205B-02	ISORA	CRISTHER	651
157A-L0205B-03	ISORA	CRISTHER	651
157A-L0205B-04	ISORA	CRISTHER	651
157A-L0205B-91	ISORA	CRISTHER	651
157A-L3805B-01	ISORA	CRISTHER	651
157A-L3805B-02	ISORA	CRISTHER	651
157A-L3805B-03	ISORA	CRISTHER	651
157A-L3805B-04	ISORA	CRISTHER	651
157A-L3805B-91	ISORA	CRISTHER	651
157B-H20X1A-01	ISORA	CRISTHER	651
157B-H20X1A-02	ISORA	CRISTHER	651
157B-H20X1A-03	ISORA	CRISTHER	651
157B-H20X1A-04	ISORA	CRISTHER	651
157B-H20X1A-91	ISORA	CRISTHER	651
157B-L01G8B-01	ISORA	CRISTHER	651
157B-L01G8B-02	ISORA	CRISTHER	651
157B-L01G8B-03	ISORA	CRISTHER	651
157B-L01G8B-04	ISORA	CRISTHER	651
157B-L01G8B-91	ISORA	CRISTHER	651
157B-L02G8B-01	ISORA	CRISTHER	651
157B-L02G8B-02	ISORA	CRISTHER	651
157B-L02G8B-03	ISORA	CRISTHER	651
157B-L02G8B-04	ISORA	CRISTHER	651
157B-L02G8B-91	ISORA	CRISTHER	651
157B-L38G8B-01	ISORA	CRISTHER	651
157B-L38G8B-02	ISORA	CRISTHER	651
157B-L38G8B-03	ISORA	CRISTHER	651
157B-L38G8B-04	ISORA	CRISTHER	651
157B-L38G8B-91	ISORA	CRISTHER	651
157C-G05X1A-01	ISORA	CRISTHER	652
157C-G05X1A-02	ISORA	CRISTHER	652
157C-G05X1A-03	ISORA	CRISTHER	652
157C-G05X1A-04	ISORA	CRISTHER	652
157C-G05X1A-91	ISORA	CRISTHER	652
157C-L0109B-01	ISORA	CRISTHER	653
157C-L0109B-02	ISORA	CRISTHER	653
157C-L0109B-03	ISORA	CRISTHER	653
157C-L0109B-04	ISORA	CRISTHER	653
157C-L0109B-91	ISORA	CRISTHER	653
157C-L01RDB-01	ISORA	CRISTHER	653
157C-L01RDB-02	ISORA	CRISTHER	653
157C-L01RDB-03	ISORA	CRISTHER	653
157C-L01RDB-04	ISORA	CRISTHER	653
157C-L01RDB-91	ISORA	CRISTHER	653
157C-L0209B-01	ISORA	CRISTHER	653
157C-L0209B-02	ISORA	CRISTHER	653
157C-L0209B-03	ISORA	CRISTHER	653
157C-L0209B-04	ISORA	CRISTHER	653
157C-L0209B-91	ISORA	CRISTHER	653
157C-L02RDB-01	ISORA	CRISTHER	653
157C-L02RDB-02	ISORA	CRISTHER	653
157C-L02RDB-03	ISORA	CRISTHER	653
157C-L02RDB-04	ISORA	CRISTHER	653

REF.	FAM.	BRAND	PAG.
157C-L02RDB-91	ISORA	CRISTHER	653
157C-L3006B-01	ISORA	CRISTHER	653
157C-L3006B-02	ISORA	CRISTHER	653
157C-L3006B-03	ISORA	CRISTHER	653
157C-L3006B-04	ISORA	CRISTHER	653
157C-L3006B-91	ISORA	CRISTHER	653
157C-L30RDB-01	ISORA	CRISTHER	653
157C-L30RDB-02	ISORA	CRISTHER	653
157C-L30RDB-03	ISORA	CRISTHER	653
157C-L30RDB-04	ISORA	CRISTHER	653
157C-L30RDB-91	ISORA	CRISTHER	653
157D-G05X1A-01	ISORA	CRISTHER	652
157D-G05X1A-02	ISORA	CRISTHER	652
157D-G05X1A-03	ISORA	CRISTHER	652
157D-G05X1A-04	ISORA	CRISTHER	652
157D-G05X1A-91	ISORA	CRISTHER	652
157D-L01G9B-01	ISORA	CRISTHER	653
157D-L01G9B-02	ISORA	CRISTHER	653
157D-L01G9B-03	ISORA	CRISTHER	653
157D-L01G9B-04	ISORA	CRISTHER	653
157D-L01G9B-91	ISORA	CRISTHER	653
157D-L01RDB-01	ISORA	CRISTHER	653
157D-L01RDB-02	ISORA	CRISTHER	653
157D-L01RDB-03	ISORA	CRISTHER	653
157D-L01RDB-04	ISORA	CRISTHER	653
157D-L01RDB-91	ISORA	CRISTHER	653
157D-L02G9B-01	ISORA	CRISTHER	653
157D-L02G9B-02	ISORA	CRISTHER	653
157D-L02G9B-03	ISORA	CRISTHER	653
157D-L02G9B-04	ISORA	CRISTHER	653
157D-L02G9B-91	ISORA	CRISTHER	653
157D-L02RDB-01	ISORA	CRISTHER	653
157D-L02RDB-02	ISORA	CRISTHER	653
157D-L02RDB-03	ISORA	CRISTHER	653
157D-L02RDB-04	ISORA	CRISTHER	653
157D-L02RDB-91	ISORA	CRISTHER	653
157D-L30G6B-01	ISORA	CRISTHER	653
157D-L30G6B-02	ISORA	CRISTHER	653
157D-L30G6B-03	ISORA	CRISTHER	653
157D-L30G6B-04	ISORA	CRISTHER	653
157D-L30G6B-91	ISORA	CRISTHER	653
157D-L30RDB-01	ISORA	CRISTHER	653
157D-L30RDB-02	ISORA	CRISTHER	653
157D-L30RDB-03	ISORA	CRISTHER	653
157D-L30RDB-04	ISORA	CRISTHER	653
157D-L30RDB-91	ISORA	CRISTHER	653
159A-G05X1A-03	JASMIN	DOPO	554
159A-G05X1A-04	JASMIN	DOPO	554
162A-G05X1A-01	JEDY	DOPO	472
166A-L0109B-01	KAPPA	DOPO	488
166A-L0109B-02	KAPPA	DOPO	488
166A-L0209B-01	KAPPA	DOPO	488
166A-L0209B-02	KAPPA	DOPO	488
166B-L0109B-01	KAPPA	DOPO	488
166B-L0109B-02	KAPPA	DOPO	488
166B-L0209B-01	KAPPA	DOPO	488
166B-L0209B-02	KAPPA	DOPO	488
167A-G05X1A-02	KEO	DOPO	585
167B-G05X1A-02	KEO	DOPO	585
167H-G05X1A-02	KEO	DOPO	585
169A-G05X1A-03	KIRA	DOPO	473
169A-G05X1A-04	KIRA	DOPO	473



REF.	FAM.	BRAND	PAG.	REF.	FAM.	BRAND	PAG.
169C-G05X1A-04	KIRA	DOPO	473	202DC-L3810FCO-00	RINS	INDELUZ	191
172A-G21X1A-30	KOBE	DOPO	526	202DC-L3814FCO-00	RINS	INDELUZ	191
184A-G05X1A-60	ANTIBES	CRISTHER	749	202DC-L3910FCO-00	RINS	INDELUZ	191
187A-L0304D-32	LYNN	CRISTHER	783	202DC-L3914FCO-00	RINS	INDELUZ	191
187A-L0404D-32	LYNN	CRISTHER	783	202DC-L4010FCO-00	RINS	INDELUZ	191
191A-L0110B-30	ARGIN	CRISTHER	691	202DC-L4014FCO-00	RINS	INDELUZ	191
191A-L0210B-30	ARGIN	CRISTHER	691	202DS-L1416FCO-00	NILO RGB+W	INDELUZ	186
194A-G05X1A-01	MEDI	DOPO	585	203AS-L3809FCO-00	NILO 5	INDELUZ	182
194A-G05X1A-02	MEDI	DOPO	585	203AS-L3814FCO-00	NILO 5	INDELUZ	182
194B-G05X1A-01	MEDI	DOPO	585	203AS-L3909FCO-00	NILO 5	INDELUZ	182
194B-G05X1A-02	MEDI	DOPO	585	203AS-L3914FCO-00	NILO 5	INDELUZ	182
200AS-L0407FCO-00	NILO RGB	INDELUZ	184	203AS-L4009FCO-00	NILO 5	INDELUZ	182
200AS-L0414FCO-00	NILO RGB	INDELUZ	184	203AS-L4014FCO-00	NILO 5	INDELUZ	182
200AS-L1416FCO-00	NILO RGB+W	INDELUZ	186	203B-G05X1A-01	MIR	DOPO	483
200AS-L3805FCO-00	NILO 8-10	INDELUZ	178	203B-G05X1A-02	MIR	DOPO	483
200AS-L3810FCO-00	NILO 8-10	INDELUZ	178	203DS-L3809FCO-00	NILO 5	INDELUZ	183
200AS-L3814FCO-00	NILO 8-10	INDELUZ	179	203DS-L3814FCO-00	NILO 5	INDELUZ	183
200AS-L3819FCO-00	NILO 8-10	INDELUZ	179	203DS-L3909FCO-00	NILO 5	INDELUZ	183
200AS-L3905FCO-00	NILO 8-10	INDELUZ	178	203DS-L3914FCO-00	NILO 5	INDELUZ	183
200AS-L3910FCO-00	NILO 8-10	INDELUZ	178	203DS-L4009FCO-00	NILO 5	INDELUZ	183
200AS-L3914FCO-00	NILO 8-10	INDELUZ	179	203DS-L4014FCO-00	NILO 5	INDELUZ	183
200AS-L3919FCO-00	NILO 8-10	INDELUZ	179	204AS-L3011FCO-00	NILO EFFICIENCY	INDELUZ	188
200AS-L4005FCO-00	NILO 8-10	INDELUZ	178	204AS-L3022FCO-00	NILO EFFICIENCY	INDELUZ	188
200AS-L4010FCO-00	NILO 8-10	INDELUZ	178	204AS-L3111FCO-00	NILO EFFICIENCY	INDELUZ	188
200AS-L4014FCO-00	NILO 8-10	INDELUZ	179	204AS-L3122FCO-00	NILO EFFICIENCY	INDELUZ	188
200AS-L4019FCO-00	NILO 8-10	INDELUZ	179	204AS-L3311FCO-00	NILO EFFICIENCY	INDELUZ	188
200DS-L0407FCO-00	NILO RGB	INDELUZ	185	204AS-L3322FCO-00	NILO EFFICIENCY	INDELUZ	188
200DS-L0414FCO-00	NILO RGB	INDELUZ	185	204CH-L3013BCO-00	VOLGA	INDELUZ	194
200DS-L1416FCO-00	NILO RGB+W	INDELUZ	186	204CH-L3017BCO-00	VOLGA	INDELUZ	195
200DS-L3805FCO-00	NILO 8-10	INDELUZ	180	204CH-L3113BCO-00	VOLGA	INDELUZ	194
200DS-L3810FCO-00	NILO 8-10	INDELUZ	180	204CH-L3117BCO-00	VOLGA	INDELUZ	195
200DS-L3814FCO-00	NILO 8-10	INDELUZ	181	204CH-L3131BCO-00	VOLGA	INDELUZ	194
200DS-L3819FCO-00	NILO 8-10	INDELUZ	181	204CH-L3317BCO-00	VOLGA	INDELUZ	195
200DS-L3905FCO-00	NILO 8-10	INDELUZ	180	204DS-L3011FCO-00	NILO EFFICIENCY	INDELUZ	189
200DS-L3910FCO-00	NILO 8-10	INDELUZ	180	204DS-L3022FCO-00	NILO EFFICIENCY	INDELUZ	189
200DS-L3914FCO-00	NILO 8-10	INDELUZ	181	204DS-L3111FCO-00	NILO EFFICIENCY	INDELUZ	189
200DS-L3919FCO-00	NILO 8-10	INDELUZ	181	204DS-L3122FCO-00	NILO EFFICIENCY	INDELUZ	189
200DS-L4005FCO-00	NILO 8-10	INDELUZ	180	204DS-L3131FCO-00	NILO EFFICIENCY	INDELUZ	189
200DS-L4010FCO-00	NILO 8-10	INDELUZ	180	204DS-L3222FCO-00	NILO EFFICIENCY	INDELUZ	189
200DS-L4014FCO-00	NILO 8-10	INDELUZ	181	205CN-L0414FCO-00	SENA RGB	INDELUZ	193
200DS-L4019FCO-00	NILO 8-10	INDELUZ	181	205CN-L3012FCO-00	SENA	INDELUZ	192
201A-G05X1A-03	MINI NICO	CRISTHER	746	205CN-L3112FCO-00	SENA	INDELUZ	192
201A-G05X1A-04	MINI NICO	CRISTHER	746	205CN-L3312FCO-00	SENA	INDELUZ	192
201A-G05X1A-90	MINI NICO	CRISTHER	746	206AS-L5213FCO-00	NILO DUAL	INDELUZ	187
201AS-L1416FCO-00	NILO RGB+W	INDELUZ	186	207CN-L3012FCO-00	SENA	INDELUZ	192
201AS-L3012FCO-00	NILO BASIC	INDELUZ	176	207CN-L3112FCO-00	SENA	INDELUZ	192
201AS-L3112FCO-00	NILO BASIC	INDELUZ	176	207CN-L3312FCO-00	SENA	INDELUZ	192
201AS-L3312FCO-00	NILO BASIC	INDELUZ	176	208A-L02X1K-03	MITRA	CRISTHER	707
201B-G05X1A-03	MINI NICO	CRISTHER	746	208A-L07X1K-03	MITRA	CRISTHER	707
201B-G05X1A-04	MINI NICO	CRISTHER	746	208B-L02X1K-03	MITRA	CRISTHER	707
201B-G05X1A-90	MINI NICO	CRISTHER	746	208B-L07X1K-03	MITRA	CRISTHER	707
201DS-L1416FCO-00	NILO RGB+W	INDELUZ	186	208C-L02X1K-03	MITRA	CRISTHER	707
201DS-L3012FCO-00	NILO BASIC	INDELUZ	177	208C-L07X1K-03	MITRA	CRISTHER	707
201DS-L3112FCO-00	NILO BASIC	INDELUZ	177	208D-L02X1K-03	MITRA	CRISTHER	707
201DS-L3312FCO-00	NILO BASIC	INDELUZ	177	208D-L07X1K-03	MITRA	CRISTHER	707
202AC-L3810FCO-00	RINS	INDELUZ	190	213A-L0102F-30	NAT-LED	CRISTHER	691
202AC-L3814FCO-00	RINS	INDELUZ	190	213A-L1002F-30	NAT-LED	CRISTHER	691
202AC-L3910FCO-00	RINS	INDELUZ	190	213B-L0102F-30	NAT-LED	CRISTHER	691
202AC-L3914FCO-00	RINS	INDELUZ	190	213B-L1002F-30	NAT-LED	CRISTHER	691
202AC-L4010FCO-00	RINS	INDELUZ	190	220B-L0203D-30	NINO	CRISTHER	783
202AC-L4014FCO-00	RINS	INDELUZ	190	220B-L0403D-30	NINO	CRISTHER	783
202AS-L1416FCO-00	NILO RGB+W	INDELUZ	186	222B-G05X1A-02	NOVA	CRISTHER	750

REF.	FAM.	BRAND	PAG.
222B-L3115B-02	NOVA	CRISTHER	750
222B-L3315B-02	NOVA	CRISTHER	750
222C-G05X1A-02	NOVA	CRISTHER	750
222C-L3115B-02	NOVA	CRISTHER	750
222C-L3315B-02	NOVA	CRISTHER	750
228A-G05X1A-01	OMO	DOPO	556
228A-G05X1A-02	OMO	DOPO	556
228A-G05X1A-04	OMO	DOPO	556
228A-G05X1A-05	OMO	DOPO	556
228A-G05X1A-91	OMO	DOPO	556
228B-G05X1A-01	OMO	DOPO	556
228B-G05X1A-02	OMO	DOPO	556
228B-G05X1A-04	OMO	DOPO	556
228B-G05X1A-05	OMO	DOPO	556
228B-G05X1A-91	OMO	DOPO	556
228C-G05X1A-01	OMO	DOPO	556
228C-G05X1A-02	OMO	DOPO	556
228C-G05X1A-04	OMO	DOPO	556
228C-G05X1A-05	OMO	DOPO	556
228C-G05X1A-91	OMO	DOPO	556
228D-G05X1A-01	OMO	DOPO	556
228D-G05X1A-02	OMO	DOPO	556
228D-G05X1A-04	OMO	DOPO	556
228D-G05X1A-05	OMO	DOPO	556
228D-G05X1A-91	OMO	DOPO	556
231A-L0304D-01	PAL	CRISTHER	782
231A-L0404D-01	PAL	CRISTHER	782
232A-G05X1A-01	PAMPERO	DOPO	472
232A-G05X1A-03	PAMPERO	DOPO	472
233A-L2415D-04	PAR 56 LED	CRISTHER	774
233A-L2427D-04	PAR 56 LED	CRISTHER	774
233B-L2416D-03	PAR 56 LED	CRISTHER	774
240A-G05X1A-01	PLAFF	CRISTHER	664
240A-G05X1A-02	PLAFF	CRISTHER	664
240B-G05X1A-01	PLAFF	CRISTHER	664
240B-G05X1A-02	PLAFF	CRISTHER	664
240C-G05X1A-01	PLAFF	CRISTHER	664
240C-G05X1A-02	PLAFF	CRISTHER	664
240D-G05X1A-01	PLAFF	CRISTHER	664
240D-G05X1A-02	PLAFF	CRISTHER	664
240E-G05X1A-01	PLAFF	CRISTHER	664
240E-G05X1A-02	PLAFF	CRISTHER	664
253A-L0316D-01	PRAGA	CRISTHER	778
253A-L0427D-01	PRAGA	CRISTHER	778
255A-G05X1A-01	PRIMA	DOPO	489
255A-G05X1A-02	PRIMA	DOPO	489
255B-G05X1A-01	PRIMA	DOPO	489
255B-G05X1A-02	PRIMA	DOPO	489
255C-G05X1A-01	PRIMA	DOPO	489
255C-G05X1A-02	PRIMA	DOPO	489
257C-L0215B-30	PUELICHE	DOPO	509
261A-L0109B-04	RIMA	CRISTHER	661
261A-L0209B-04	RIMA	CRISTHER	661
261C-L0105B-04	RIMA	CRISTHER	661
261C-L0205B-04	RIMA	CRISTHER	661
264A-G05X1A-01	ROB	DOPO	608
264A-G05X1A-02	ROB	DOPO	608
264B-G05X1A-01	ROB	DOPO	608
264B-G05X1A-02	ROB	DOPO	608
264C-G05X1A-01	ROB	DOPO	608
264C-G05X1A-02	ROB	DOPO	608
264D-G05X1A-01	ROB	DOPO	608

REF.	FAM.	BRAND	PAG.
264D-G05X1A-02	ROB	DOPO	608
264E-G05X1A-01	ROB	DOPO	608
264E-G05X1A-02	ROB	DOPO	608
264G-G05X1A-01	ROB	DOPO	609
264G-G05X1A-02	ROB	DOPO	609
264H-G05X1A-01	ROB	DOPO	609
264H-G05X1A-02	ROB	DOPO	609
264K-G05X1A-01	ROB	DOPO	609
264K-G05X1A-02	ROB	DOPO	609
264L-G05X1A-01	ROB	DOPO	609
264L-G05X1A-02	ROB	DOPO	609
264M-G05X1A-01	ROB	DOPO	610
264M-G05X1A-02	ROB	DOPO	610
264N-G05X1A-01	ROB	DOPO	610
264N-G05X1A-02	ROB	DOPO	610
264O-G05X1A-01	ROB	DOPO	610
264O-G05X1A-02	ROB	DOPO	610
264P-G05X1A-01	ROB	DOPO	610
264P-G05X1A-02	ROB	DOPO	610
264Q-G05X1A-01	ROB	DOPO	610
264Q-G05X1A-02	ROB	DOPO	610
264R-G05X1A-01	ROB	DOPO	610
264R-G05X1A-02	ROB	DOPO	610
272A-G05X1A-02	SAURO	DOPO	558
272A-G31X1A-02	SAURO	DOPO	558
272B-G05X1A-02	SAURO	DOPO	558
272B-G31X1A-02	SAURO	DOPO	558
272C-G05X1A-02	SAURO	DOPO	558
272C-G31X1A-02	SAURO	DOPO	558
279A-G21X1A-02	SENDAI	DOPO	521
279A-G21X1A-03	SENDAI	DOPO	521
286A-G05X1A-03	SIROCO	DOPO	557
286A-G05X1A-04	SIROCO	DOPO	557
289B-L0104B-03	SLIM	CRISTHER	658
289B-L0104B-04	SLIM	CRISTHER	658
289B-L0204B-03	SLIM	CRISTHER	658
289B-L0204B-04	SLIM	CRISTHER	658
289C-L0110B-03	SLIM	CRISTHER	658
289C-L0110B-04	SLIM	CRISTHER	658
289C-L0210B-03	SLIM	CRISTHER	658
289C-L0210B-04	SLIM	CRISTHER	658
289D-L0104B-03	SLIM	CRISTHER	659
289D-L0104B-04	SLIM	CRISTHER	659
289D-L0204B-03	SLIM	CRISTHER	659
289D-L0204B-04	SLIM	CRISTHER	659
289E-L0110B-03	SLIM	CRISTHER	659
289E-L0110B-04	SLIM	CRISTHER	659
289E-L0210B-03	SLIM	CRISTHER	659
289E-L0210B-04	SLIM	CRISTHER	659
302A-L0105B-04	SURI	CRISTHER	695
302A-L0205B-04	SURI	CRISTHER	695
302B-L0105B-04	SURI	CRISTHER	695
302B-L0205B-04	SURI	CRISTHER	695
302C-L0105B-04	SURI	CRISTHER	695
302C-L0205B-04	SURI	CRISTHER	695
303A-L0106A-04	SURI BIG	CRISTHER	695
303A-L0206A-04	SURI BIG	CRISTHER	695
303B-L0106A-04	SURI BIG	CRISTHER	695
303B-L0206A-04	SURI BIG	CRISTHER	695
303C-L0106A-04	SURI BIG	CRISTHER	695
303C-L0206A-04	SURI BIG	CRISTHER	695
305A-L9804H-30	SYNA	CRISTHER	668

REF.	FAM.	BRAND	PAG.	REF.	FAM.	BRAND	PAG.
305B-L0104H-30	SYNA	CRISTHER	668	378C-L3111A-02	LED T2	NX Lighting	790
305C-L0102F-30	SYNA	CRISTHER	669	378C-L4111A-01	LED T2	NX Lighting	790
317A-G05X1A-01	TEIA	DOPO	485	379A-G31X1A-30	SIO	DOPO	505
317A-G05X1A-02	TEIA	DOPO	485	379B-G31X1A-30	SIO	DOPO	505
317A-G05X1A-03	TEIA	DOPO	485	382A-L0316D-30	GAMBLE-PLUS	CRISTHER	784
317B-G05X1A-01	TEIA	DOPO	485	382A-L0422D-30	GAMBLE-PLUS	CRISTHER	784
317B-G05X1A-02	TEIA	DOPO	485	386A-L0427D-00	PAR 56 LED	CRISTHER	775
317B-G05X1A-03	TEIA	DOPO	485	386B-L0427D-00	PAR 56 ONLED	CRISTHER	775
317C-G05X1A-01	TEIA	DOPO	485	387A-L2458D-03	PAR 56 ONLED	CRISTHER	774
317C-G05X1A-02	TEIA	DOPO	485	388A-L3020B-04	MAXIMA	CRISTHER	744
317C-G05X1A-03	TEIA	DOPO	485	388A-L30RDB-04	MAXIMA	CRISTHER	744
319A-L2105A-02	TIR	CRISTHER	724	388A-L3120B-04	MAXIMA	CRISTHER	744
319A-L2105A-03	TIR	CRISTHER	724	388A-L31RDB-04	MAXIMA	CRISTHER	744
321A-G05X1A-03	KIRA	DOPO	473	388B-L3020B-04	MAXIMA	CRISTHER	744
321A-G05X1A-04	KIRA	DOPO	473	388B-L30RDB-04	MAXIMA	CRISTHER	744
332B-G05X1A-01	TROM	DOPO	586	388B-L3120B-04	MAXIMA	CRISTHER	744
332B-G05X1A-02	TROM	DOPO	586	388B-L31RDB-04	MAXIMA	CRISTHER	744
332D-G05X1A-01	TROM	DOPO	587	388C-L3036B-04	MAXIMA	CRISTHER	745
332D-G05X1A-02	TROM	DOPO	587	388C-L30RDB-04	MAXIMA	CRISTHER	745
332E-G05X1A-01	TROM	DOPO	587	388C-L3136B-04	MAXIMA	CRISTHER	745
332E-G05X1A-02	TROM	DOPO	587	388C-L31RDB-04	MAXIMA	CRISTHER	745
332F-G05X1A-01	TROM	DOPO	587	388D-L3036B-04	MAXIMA	CRISTHER	745
332F-G05X1A-02	TROM	DOPO	587	388D-L30RDB-04	MAXIMA	CRISTHER	745
332G-G05X1A-01	TROM	DOPO	586	388D-L3136B-04	MAXIMA	CRISTHER	745
332G-G05X1A-02	TROM	DOPO	586	388D-L31RDB-04	MAXIMA	CRISTHER	745
338A-L02X1K-29	UTU MINI	CRISTHER	707	388E-L3036B-04	MAXIMA	CRISTHER	745
338A-L07X1K-29	UTU MINI	CRISTHER	707	388E-L30RDB-04	MAXIMA	CRISTHER	745
339A-L02X1K-29	UTU ROUND	CRISTHER	707	388E-L3136B-04	MAXIMA	CRISTHER	745
339A-L07X1K-29	UTU ROUND	CRISTHER	707	388E-L31RDB-04	MAXIMA	CRISTHER	745
344A-G05X1A-02	VIC	DOPO	596	392A-G05X1A-01	BLOCK	CRISTHER	771
344B-G05X1A-02	VIC	DOPO	596	392B-G05X1A-01	BLOCK	CRISTHER	771
344C-G05X1A-02	VIC	DOPO	596	392C-G05X1A-01	BLOCK	CRISTHER	771
344E-G05X1A-02	VIC	DOPO	596	393A-G05X1A-01	BALLON	CRISTHER	770
345A-G05X1A-02	VIC	DOPO	596	393B-G05X1A-01	BALLON	CRISTHER	770
345B-G05X1A-02	VIC	DOPO	596	394A-G05X1A-01	CYLINDER	CRISTHER	769
345C-G05X1A-02	VIC	DOPO	596	394B-G05X1A-01	CYLINDER	CRISTHER	769
345D-G05X1A-02	VIC	DOPO	596	398A-G21X1A-04	SETH	CRISTHER	656
346B-G05X1A-02	VILLA BIG	DOPO	630	398A-G21X1A-90	SETH	CRISTHER	656
346D-G05X1A-02	VILLA BIG	DOPO	631	398A-L0105B-04	SETH	CRISTHER	656
348B-G05X1A-02	VILLA CHAP	DOPO	614	398A-L0105B-90	SETH	CRISTHER	656
348D-G05X1A-02	VILLA CHAP	DOPO	614	398A-L0205B-04	SETH	CRISTHER	656
349A-G05X1A-30	WALKER	DOPO	508	398A-L0205B-90	SETH	CRISTHER	656
349A-L0107B-30	WALKER	DOPO	508	398B-G21X1A-04	SETH	CRISTHER	656
350A-G05X1A-01	XALOC	DOPO	497	398B-G21X1A-90	SETH	CRISTHER	656
350A-G05X1A-02	XALOC	DOPO	497	398B-L01C4B-04	SETH	CRISTHER	656
350C-G05X1A-30	XALOC	DOPO	497	398B-L01C4B-90	SETH	CRISTHER	656
350D-G05X1A-30	XALOC	DOPO	497	398B-L02C4B-04	SETH	CRISTHER	656
369D-L2003B-01	G9	NX Lighting	792	398B-L02C4B-90	SETH	CRISTHER	656
369D-L2003B-02	G9	NX Lighting	792	398C-G21X1A-04	SETH	CRISTHER	657
372A-G31X1A-02	BELGRADO	DOPO	511	398C-G21X1A-90	SETH	CRISTHER	657
372B-G31X1A-02	BELGRADO	DOPO	511	398C-L0109B-04	SETH	CRISTHER	657
372C-G31X1A-02	BELGRADO	DOPO	511	398C-L0109B-90	SETH	CRISTHER	657
373A-G31X1A-02	BELGRADO	DOPO	511	398C-L01G9B-04	SETH	CRISTHER	657
373B-G31X1A-02	BELGRADO	DOPO	511	398C-L01G9B-90	SETH	CRISTHER	657
373C-G31X1A-02	BELGRADO	DOPO	511	398C-L0209B-04	SETH	CRISTHER	657
378A-L3103A-02	LED T2	NX Lighting	790	398C-L0209B-90	SETH	CRISTHER	657
378A-L3106A-01	LED T2	NX Lighting	790	398C-L02G9B-04	SETH	CRISTHER	657
378A-L3106A-02	LED T2	NX Lighting	790	398C-L02G9B-90	SETH	CRISTHER	657
378A-L4103A-01	LED T2	NX Lighting	790	398E-G21X1A-04	SETH	CRISTHER	657
378B-L3107A-02	LED T2	NX Lighting	790	398E-G21X1A-90	SETH	CRISTHER	657
378B-L5210A-01	LED T2	NX Lighting	790	399B-G21X1A-04	SETH	CRISTHER	654
378C-L3111A-01	LED T2	NX Lighting	790	399B-G21X1A-90	SETH	CRISTHER	654

REF.	FAM.	BRAND	PAG.
399B-L0108B-04	SETH	CRISTHER	654
399B-L0108B-90	SETH	CRISTHER	654
399B-L0208B-04	SETH	CRISTHER	654
399B-L0208B-90	SETH	CRISTHER	654
399C-G05X1A-04	SETH	CRISTHER	655
399C-G05X1A-90	SETH	CRISTHER	655
399C-L0118B-04	SETH	CRISTHER	655
399C-L0118B-90	SETH	CRISTHER	655
399C-L01H3B-04	SETH	CRISTHER	655
399C-L01H3B-90	SETH	CRISTHER	655
399C-L0218B-04	SETH	CRISTHER	655
399C-L0218B-90	SETH	CRISTHER	655
399C-L02H3B-04	SETH	CRISTHER	655
399C-L02H3B-90	SETH	CRISTHER	655
399D-G05X1A-04	SETH	CRISTHER	655
399D-G05X1A-90	SETH	CRISTHER	655
399E-G21X1A-04	SETH	CRISTHER	654
399E-G21X1A-90	SETH	CRISTHER	654
399E-L0105B-04	SETH	CRISTHER	654
399E-L0105B-90	SETH	CRISTHER	654
399E-L0205B-04	SETH	CRISTHER	654
399E-L0205B-90	SETH	CRISTHER	654
401A-G05X1A-03	DUBLIN	CRISTHER	667
401A-G05X1A-04	DUBLIN	CRISTHER	667
401A-L0113B-03	DUBLIN	CRISTHER	667
401A-L0113B-04	DUBLIN	CRISTHER	667
401B-G05X1A-03	DUBLIN	CRISTHER	667
401B-G05X1A-04	DUBLIN	CRISTHER	667
401B-L0113B-03	DUBLIN	CRISTHER	667
401B-L0113B-04	DUBLIN	CRISTHER	667
402A-L0112B-02	LISBOA	CRISTHER	727
402B-L0139B-02	LISBOA	CRISTHER	727
402C-L0151B-02	LISBOA	CRISTHER	727
403A-L0112B-01	VIENA	CRISTHER	662
403B-L0130B-01	VIENA	CRISTHER	662
403B-L01RDB-01	VIENA	CRISTHER	662
404A-L0112B-30	SOFIA	CRISTHER	689
404A-L0118B-30	SOFIA	CRISTHER	689
404B-L0118B-30	SOFIA	CRISTHER	689
404B-L0127B-30	SOFIA	CRISTHER	689
405C-G05X1A-04	ROUND	DOPO	605
405D-G05X1A-04	ROUND	DOPO	605
406C-G05X1A-04	QUADRA	DOPO	606
406D-G05X1A-04	QUADRA	DOPO	606
407B-G31X1A-02	GUNTHER	DOPO	632
407D-G31X1A-02	GUNTHER	DOPO	633
407E-G31X1A-02	GUNTHER	DOPO	633
408B-G31X1A-02	GUNTHER	DOPO	634
408D-G31X1A-02	GUNTHER	DOPO	634
408E-G31X1A-02	GUNTHER	DOPO	634
410A-G21X1A-30	ESTAMBUL	CRISTHER	683
410A-G21X1A-34	ESTAMBUL	CRISTHER	683
412A-L0103B-01	BRICK	EXO	309
412A-L0103B-02	BRICK	EXO	309
412A-L0103B-40	BRICK	EXO	309
412B-L01E2B-01	BRICK	EXO	309
412B-L01E2B-02	BRICK	EXO	309
412B-L01E2B-40	BRICK	EXO	309
412B-L01F1B-01	BRICK	EXO	309
412B-L01F1B-02	BRICK	EXO	309
412B-L01F1B-40	BRICK	EXO	309
443A-L0107A-04	RHIN	DOPO	459

REF.	FAM.	BRAND	PAG.
445A-L0107A-04	ARTAL	DOPO	468
447A-G31X1A-04	GUIJU	DOPO	545
447B-L01D6A-04	GUIJU	DOPO	467
448A-G05X1A-04	NATAN	DOPO	557
452A-L0107A-04	SUEVIS	DOPO	546
452B-L0107A-04	SUEVIS	DOPO	466
455A-L0105A-04	SIBILA	DOPO	552
455B-L0110B-01	SIBILA	DOPO	552
455B-L0110B-04	SIBILA	DOPO	552
458A-G05X1A-04	TASMANIA	CRISTHER	768
463A-G21X1A-02	GERONIMO	DOPO	523
482A-L0107A-04	CATANIA	DOPO	524
483A-L0112B-01	ALDIOLA	CRISTHER	649
483A-L0112B-03	ALDIOLA	CRISTHER	649
483B-L0107B-01	ALDIOLA	CRISTHER	649
483B-L0107B-03	ALDIOLA	CRISTHER	649
483C-L01C1B-01	ALDIOLA	CRISTHER	649
483C-L01C1B-03	ALDIOLA	CRISTHER	649
483C-L01RDB-01	ALDIOLA	CRISTHER	649
483C-L01RDB-03	ALDIOLA	CRISTHER	649
485A-G21X1A-04	ABBI	CRISTHER	724
492A-L0105B-02	CLINA	CRISTHER	748
492A-L0105B-90	CLINA	CRISTHER	748
492A-L0205B-02	CLINA	CRISTHER	748
492A-L0205B-90	CLINA	CRISTHER	748
492A-L3805B-02	CLINA	CRISTHER	748
492A-L3805B-90	CLINA	CRISTHER	748
500A-G05X1A-32	CARPI	EXO	429
504A-L0108B-01	RETT	EXO	303
504A-L0108B-02	RETT	EXO	303
504A-L0108B-40	RETT	EXO	303
504A-L0108B-46	RETT	EXO	303
504A-L0108B-BR	RETT	EXO	303
504B-L0124B-01	RETT	EXO	303
504B-L0124B-02	RETT	EXO	303
504B-L0124B-40	RETT	EXO	303
504B-L0124B-46	RETT	EXO	303
504B-L0124B-BR	RETT	EXO	303
504C-L0105B-01	RETT	EXO	303
504C-L0105B-02	RETT	EXO	303
504C-L0105B-40	RETT	EXO	303
504C-L0105B-46	RETT	EXO	303
504C-L0105B-BR	RETT	EXO	303
507A-Y05X1B-35	FIRENZE	EXO	285
507A-Y05X1B-46	FIRENZE	EXO	285
507B-G05X1A-35	FIRENZE	EXO	286
507C-G05X1A-35	FIRENZE	EXO	399
507D-G05X1A-35	FIRENZE	EXO	398
507E-Y05X1B-35	FIRENZE	EXO	285
507F-Y05X1B-35	FIRENZE	EXO	285
507F-Y05X1B-46	FIRENZE	EXO	285
507G-G05X1A-09	FIRENZE	EXO	353
507G-G05X1A-29	FIRENZE	EXO	353
513A-L0109B-32	SHEID	EXO	428
513B-L0118B-32	SHEID	EXO	428
514A-L0109B-32	LITS	EXO	428
514B-L0112B-32	LITS	EXO	428
517B-L0103B-35	LEIDEN	EXO	301
517B-L0103B-46	LEIDEN	EXO	301
517E-L0103B-35	LEIDEN	EXO	301
517E-L0103B-46	LEIDEN	EXO	301
518B-L0103A-35	OLVAS	EXO	300

REF.	FAM.	BRAND	PAG.	REF.	FAM.	BRAND	PAG.
522A-L0214B-03	DELFI	DOPO	483	575B-G05X1A-04	DAIRA	CRISTHER	663
534A-L0109A-04	CASTELLO	DOPO	456	575B-L0118B-01	DAIRA	CRISTHER	663
534B-L0109A-04	CASTELLO	DOPO	548	575B-L0118B-04	DAIRA	CRISTHER	663
534C-L0109B-04	CASTELLO	DOPO	456	575C-G05X1A-01	DAIRA	CRISTHER	663
534D-L0109B-04	CASTELLO	DOPO	548	575C-G05X1A-04	DAIRA	CRISTHER	663
536A-L0106A-04	CENADI	DOPO	468	575C-L0118B-01	DAIRA	CRISTHER	663
537A-L0107A-04	CAIRO	DOPO	467	575C-L0118B-04	DAIRA	CRISTHER	663
537B-L0107A-04	CAIRO	DOPO	547	578A-L2104A-02	LED PRO	NX Lighting	792
538A-G21X1A-04	ABADIA	DOPO	518	578A-L4104A-01	LED PRO	NX Lighting	792
539A-G21X1A-04	ARAMO	DOPO	524	578B-L4106B-01	LED PRO	INDELUZ	262
543A-L0103A-03	DAMBEL	DOPO	494	579C-G31X1A-01	BELENLUX	DOPO	482
543A-L0103A-04	DAMBEL	DOPO	494	579C-L0216R-01	BELENLUX	DOPO	482
543B-L0103A-03	DAMBEL	DOPO	494	580A-L0104B-03	SLJM	CRISTHER	658
543B-L0103A-04	DAMBEL	DOPO	494	580A-L0104B-04	SLJM	CRISTHER	658
544A-L0105A-30	DAS	DOPO	496	580A-L0204B-03	SLJM	CRISTHER	658
546A-L0101A-30	DONISI	DOPO	499	580A-L0204B-04	SLJM	CRISTHER	658
551B-L0108A-04	BARNI	DOPO	520	580B-L0110B-03	SLJM	CRISTHER	658
552A-L0108A-04	ADRANO	DOPO	551	580B-L0110B-04	SLJM	CRISTHER	658
554A-L0108A-04	BINDELLA	CRISTHER	746	580B-L0210B-03	SLJM	CRISTHER	658
554A-L01RDB-04	BINDELLA	CRISTHER	746	580B-L0210B-04	SLJM	CRISTHER	658
555C-G21X1A-01	CUB	DOPO	465	580C-L0104B-03	SLJM	CRISTHER	659
555C-G21X1A-02	CUB	DOPO	465	580C-L0104B-04	SLJM	CRISTHER	659
555C-G21X1A-03	CUB	DOPO	465	580C-L0204B-03	SLJM	CRISTHER	659
555C-G21X1A-04	CUB	DOPO	465	580C-L0204B-04	SLJM	CRISTHER	659
555D-G21X1A-01	CUB	DOPO	465	580D-L0110B-03	SLJM	CRISTHER	659
555D-G21X1A-02	CUB	DOPO	465	580D-L0110B-04	SLJM	CRISTHER	659
555D-G21X1A-03	CUB	DOPO	465	580D-L0210B-03	SLJM	CRISTHER	659
555D-G21X1A-04	CUB	DOPO	465	580D-L0210B-04	SLJM	CRISTHER	659
555E-G21X1A-01	CUB	DOPO	500	583C-L3140B-01	HIMMEL	INDELUZ	233
555E-G21X1A-02	CUB	DOPO	500	583C-L3340B-01	HIMMEL	INDELUZ	233
555E-G21X1A-03	CUB	DOPO	500	585A-G05X1A-02	VINTAGE	EXO	371
555E-G21X1A-04	CUB	DOPO	500	588A-L0104A-02	BOOK	EXO	291
555F-G21X1A-01	CUB	DOPO	463	589A-G05X1A-35	CIRCUS	EXO	311
555F-G21X1A-04	CUB	DOPO	463	595A-G05X1A-35	EASY	EXO	369
555G-G21X1A-01	CUB	DOPO	463	599A-L3106A-01	GIA	INDELUZ	234
555G-G21X1A-04	CUB	DOPO	463	599A-L3118A-01	GIA	INDELUZ	234
557A-G21X1A-02	BELGRADO	DOPO	511	599A-L3124A-01	GIA	INDELUZ	234
557B-G21X1A-02	BELGRADO	DOPO	511	599A-L3306A-01	GIA	INDELUZ	234
557C-G21X1A-02	BELGRADO	DOPO	511	599A-L3318A-01	GIA	INDELUZ	234
559A-G31X1A-01	PIRO	DOPO	484	599A-L3324A-01	GIA	INDELUZ	234
559A-G31X1A-03	PIRO	DOPO	484	599B-L3106A-01	GIA	INDELUZ	235
559B-G31X1A-01	PIRO	DOPO	484	599B-L3118A-01	GIA	INDELUZ	235
559B-G31X1A-02	PIRO	DOPO	484	599B-L3124A-01	GIA	INDELUZ	235
559B-G31X1A-03	PIRO	DOPO	484	599B-L3306A-01	GIA	INDELUZ	235
559C-G31X1A-01	PIRO	DOPO	484	599B-L3318A-01	GIA	INDELUZ	235
559C-G31X1A-02	PIRO	DOPO	484	599B-L3324A-01	GIA	INDELUZ	235
568A-L0135B-04	VICO	CRISTHER	762	599C-L3106A-01	GIA	INDELUZ	236
568A-L0150B-04	VICO	CRISTHER	762	599C-L3118A-01	GIA	INDELUZ	236
568A-L0235B-04	VICO	CRISTHER	762	599C-L3306A-01	GIA	INDELUZ	236
568A-L0250B-04	VICO	CRISTHER	762	599C-L3318A-01	GIA	INDELUZ	236
569A-L0130B-01	VIENA	CRISTHER	662	599D-L3106A-01	GIA	INDELUZ	236
569A-L01RDB-01	VIENA	CRISTHER	662	599D-L3118A-01	GIA	INDELUZ	236
569B-L0112B-01	VIENA	CRISTHER	662	599D-L3306A-01	GIA	INDELUZ	236
571A-G31X1A-02	CAYU	DOPO	477	599D-L3318A-01	GIA	INDELUZ	236
572A-G21X1A-02	LULU	DOPO	523	612A-G05X1A-32	PYRAMID	EXO	311
573A-G05X1A-34	OTTONE	DOPO	584	618A-G05X1A-02	TANNA	EXO	367
573B-G05X1A-34	OTTONE	DOPO	584	620A-G05X1A-02	VINTAGE	EXO	371
575A-G05X1A-01	DAIRA	CRISTHER	663	621A-G05X1A-50	WOOD	EXO	407
575A-G05X1A-04	DAIRA	CRISTHER	663	621B-G05X1A-50	WOOD	EXO	407
575A-L0129R-01	DAIRA	CRISTHER	663	621C-G05X1A-50-CA	COMPACT	EXO	282
575A-L0129R-04	DAIRA	CRISTHER	663	621C-G05X1A-50-CG	COMPACT	EXO	282
575B-G05X1A-01	DAIRA	CRISTHER	663	621C-G05X1A-50-DC	COMPACT	EXO	282

REFERENCE INDEX PVP

REF.	FAM.	BRAND	PAG.
621D-G05X1A-50-CA	COMPACT	EXO	400
621D-G05X1A-50-CG	COMPACT	EXO	400
621D-G05X1A-50-DC	COMPACT	EXO	400
621E-G05X1A-50-CA	COMPACT	EXO	401
621E-G05X1A-50-CG	COMPACT	EXO	401
621E-G05X1A-50-DC	COMPACT	EXO	401
622A-G05X1A-02	ZANZIBAR	EXO	413
632C-L0506B-01	LED FILAMENT	NX Lighting	791
632C-L0506B-02	LED FILAMENT	NX Lighting	791
632D-L0404B-01	LED FILAMENT	NX Lighting	791
632E-L0404B-01	LED FILAMENT	NX Lighting	791
632F-L0504B-01	LED FILAMENT	NX Lighting	791
632G-L0504B-01	LED FILAMENT	NX Lighting	791
632H-L0504B-01	LED FILAMENT	NX Lighting	791
632J-L0503B-01	LED FILAMENT	NX Lighting	791
634A-H35X1A-01	IONA	EXO	308
634A-H35X1A-02	IONA	EXO	308
634A-H35X1A-03	IONA	EXO	308
634A-L0113B-01	IONA	EXO	308
634A-L0113B-02	IONA	EXO	308
634A-L0113B-03	IONA	EXO	308
634B-L0113B-01	IONA	EXO	308
634B-L0113B-02	IONA	EXO	308
634B-L0113B-03	IONA	EXO	308
634C-G05X1A-01	IONA	EXO	308
634C-G05X1A-02	IONA	EXO	308
634C-G05X1A-03	IONA	EXO	308
638A-VX60B-01	FUJIL	EXO	439
642A-G23X1D-30	SEDNA	DOPO	527
642A-L0203D-30	SEDNA	DOPO	527
643A-L0109A-04	AMBERES	DOPO	496
645A-L0107A-04	MARTINA	DOPO	510
645A-L0207A-04	MARTINA	DOPO	510
645B-L0107A-04	MARTINA	DOPO	510
645B-L0207A-04	MARTINA	DOPO	510
646A-G05X1A-01	CALM	DOPO	480
646A-G05X1A-02	CALM	DOPO	480
646A-G05X1A-03	CALM	DOPO	480
646B-G05X1A-01	CALM	DOPO	480
646B-G05X1A-02	CALM	DOPO	480
646B-G05X1A-03	CALM	DOPO	480
655A-G31X1A-02	GUNTHER	DOPO	635
659A-G05X1A-04	GEOMETRIC	CRISTHER	647
659A-G05X1A-11	GEOMETRIC	CRISTHER	647
659A-G05X1A-90	GEOMETRIC	CRISTHER	647
661A-L0304D-30	PAL	CRISTHER	782
661A-L0404D-30	PAL	CRISTHER	782
665B-L0102F-43	NODY	CRISTHER	694
665B-L0202F-43	NODY	CRISTHER	694
665C-L0102F-43	NODY	CRISTHER	694
665C-L0202F-43	NODY	CRISTHER	694
665E-L0102F-43	NODY	CRISTHER	694
665E-L0202F-43	NODY	CRISTHER	694
665F-L0102F-43	NODY	CRISTHER	694
665F-L0202F-43	NODY	CRISTHER	694
669A-G05X1A-02	MIRCO	CRISTHER	753
669B-L0113B-02	MIRCO	CRISTHER	753
669B-L0213B-02	MIRCO	CRISTHER	753
669C-G05X1A-02	MIRCO	CRISTHER	753
669D-G05X1A-02	MIRCO	CRISTHER	753
673A-L0224A-39	ARYA	CRISTHER	762
673A-L0236A-39	ARYA	CRISTHER	762

REF.	FAM.	BRAND	PAG.
673A-L3024A-39	ARYA	CRISTHER	762
673A-L3024AAD-39	ARYA	CRISTHER	762
673A-L3036A-39	ARYA	CRISTHER	762
673A-L3036AAD-39	ARYA	CRISTHER	762
673A-L3224AAD-39	ARYA	CRISTHER	762
673A-L3236AAD-39	ARYA	CRISTHER	762
681A-G05X1A-02	BRITTA	EXO	283
681B-G05X1A-02	BRITTA	EXO	402
681C-G05X1A-02	BRITTA	EXO	403
684A-G05X1A-02	ELGA	EXO	364
685A-G05X1A-02	BAGUET	EXO	363
685B-G05X1A-02	BAGUET	EXO	363
693A-L0112A-35	ESPIGA	EXO	311
694A-L0112B-35	MENKAR	EXO	311
695A-L0112B-01	DENEK	EXO	310
695A-L0112B-32	DENEK	EXO	310
703A-G05X1A-02	KARA	EXO	409
703A-G05X1A-50	KARA	EXO	409
703B-G05X1A-02	KARA	EXO	408
703B-G05X1A-50	KARA	EXO	408
704A-L0103B-01	DIRK	EXO	292
704A-L0103B-02	DIRK	EXO	292
704A-L0103B-02-47	DIRK	EXO	292
704B-L0103B-01	DIRK	EXO	292
704B-L0103B-02	DIRK	EXO	292
704B-L0103B-02-47	DIRK	EXO	292
706A-L0103B-01	LIGUR	INDELUZ	245
706A-L0103B-39	LIGUR	INDELUZ	245
706B-L0103B-01	LIGUR	INDELUZ	245
706B-L0103B-39	LIGUR	INDELUZ	245
710A-L0103A-02	ELFI	EXO	300
710A-L0103A-07	ELFI	EXO	300
710B-L0103A-02	ELFI	EXO	300
710B-L0103A-07	ELFI	EXO	300
715A-L0125A-01	FRED	EXO	359
715A-L0125A-02	FRED	EXO	359
715A-L0125A-03	FRED	EXO	359
715B-L3135A-01	FRED	EXO	359
715B-L3135A-02	FRED	EXO	359
715B-L3135A-03	FRED	EXO	359
716A-G05X1A-03	A TU ESTILO	EXO	361
716A-G05X1A-07	A TU ESTILO	EXO	361
716A-G05X1A-09	A TU ESTILO	EXO	361
716A-G05X1A-29	A TU ESTILO	EXO	361
716B-G05X1A-03	A TU ESTILO	EXO	361
716B-G05X1A-07	A TU ESTILO	EXO	361
716B-G05X1A-09	A TU ESTILO	EXO	361
716B-G05X1A-29	A TU ESTILO	EXO	361
717C-G05X1A-02	A TU ESTILO	EXO	287
717C-G05X1A-32	A TU ESTILO	EXO	287
717D-G05X1A-01	A TU ESTILO	EXO	365
717D-G05X1A-02	A TU ESTILO	EXO	365
717D-G05X1A-32	A TU ESTILO	EXO	365
717E-G05X1A-01	A TU ESTILO	EXO	365
717E-G05X1A-02	A TU ESTILO	EXO	365
717E-G05X1A-32	A TU ESTILO	EXO	365
717F-G05X1A-01	A TU ESTILO	EXO	365
717F-G05X1A-02	A TU ESTILO	EXO	365
717F-G05X1A-32	A TU ESTILO	EXO	365
717G-G05X1A-02	A TU ESTILO	EXO	361
717G-G05X1A-03	A TU ESTILO	EXO	361
726A-L0103B-01	WINDOW 2	INDELUZ	244

REF.	FAM.	BRAND	PAG.	REF.	FAM.	BRAND	PAG.
726A-L0103B-39	WINDOW 2	INDELUZ	244	741A-G42X1B-45	MINI LUNA	INDELUZ	223
727G-L0103B-01	BALTIC	EXO	298	741A-G42X1B-48	MINI LUNA	INDELUZ	223
727G-L0103B-02	BALTIC	EXO	298	749B-	KOS	INDELUZ	87
731B-L4118B-01	CARME	INDELUZ	237	749B-G23XID-01	KOS	INDELUZ	227
731C-L4130B-01	CARME	INDELUZ	237	749B-G42X1B-01	KOS	INDELUZ	227
731D-L4118B-28	CARME	INDELUZ	237	750A-	PALMA	INDELUZ	77
731E-L4130B-28	CARME	INDELUZ	237	750A-G23XID-01	PALMA	INDELUZ	222
731F-L4118R-28	CARME	INDELUZ	237	750A-G23XID-02	PALMA	INDELUZ	222
731G-L4130R-28	CARME	INDELUZ	237	750A-G23XID-30	PALMA	INDELUZ	222
738F-G18RCB-01	ATOLON	INDELUZ	218	750A-G23XID-32	PALMA	INDELUZ	222
738F-G18RCB-02	ATOLON	INDELUZ	218	750A-G23XID-45	PALMA	INDELUZ	222
738F-G18RCB-03	ATOLON	INDELUZ	218	750A-G23XID-48	PALMA	INDELUZ	222
738F-G21X1B-01	ATOLON	INDELUZ	218	750A-G42X1B-01	PALMA	INDELUZ	222
738F-G21X1B-02	ATOLON	INDELUZ	218	750A-G42X1B-02	PALMA	INDELUZ	222
738F-G21X1B-03	ATOLON	INDELUZ	218	750A-G42X1B-30	PALMA	INDELUZ	222
738Q-L3117B1M-01	ATOLON	INDELUZ	90	750A-G42X1B-32	PALMA	INDELUZ	222
738Q-L3117B1M-02	ATOLON	INDELUZ	90	750A-G42X1B-45	PALMA	INDELUZ	222
738Q-L3117B1M-03	ATOLON	INDELUZ	90	750A-G42X1B-48	PALMA	INDELUZ	222
738Q-L3125B-01	ATOLON	INDELUZ	90	752A-	LEDA	INDELUZ	86
738Q-L3125B-02	ATOLON	INDELUZ	90	752A-G23XID-01	LEDA	INDELUZ	229
738Q-L3125B-03	ATOLON	INDELUZ	90	752A-G23XID-02	LEDA	INDELUZ	229
738Q-L31R2B-01	ATOLON	INDELUZ	90	752A-G23XID-03	LEDA	INDELUZ	229
738Q-L31R2B-02	ATOLON	INDELUZ	90	752A-G42X1B-01	LEDA	INDELUZ	229
738Q-L31R2B-03	ATOLON	INDELUZ	90	752A-G42X1B-02	LEDA	INDELUZ	229
738Q-L3317B1M-01	ATOLON	INDELUZ	90	752A-G42X1B-03	LEDA	INDELUZ	229
738Q-L3317B1M-02	ATOLON	INDELUZ	90	753A-L3202B-01	IBIZA	INDELUZ	231
738Q-L3317B1M-03	ATOLON	INDELUZ	90	753A-L3202B-02	IBIZA	INDELUZ	231
738Q-L3325B-01	ATOLON	INDELUZ	90	753A-L3202B-32	IBIZA	INDELUZ	231
738Q-L3325B-02	ATOLON	INDELUZ	90	753A-L3202B-45	IBIZA	INDELUZ	231
738Q-L3325B-03	ATOLON	INDELUZ	90	753B-L3202B-01	IBIZA	INDELUZ	231
738Q-L33R2B-01	ATOLON	INDELUZ	90	753B-L3202B-02	IBIZA	INDELUZ	231
738Q-L33R2B-02	ATOLON	INDELUZ	90	753B-L3202B-32	IBIZA	INDELUZ	231
738Q-L33R2B-03	ATOLON	INDELUZ	90	753B-L3202B-45	IBIZA	INDELUZ	231
738R-L3117B2M-01	ATOLON	INDELUZ	90	757B-L3108B-01	KALE	INDELUZ	228
738R-L3117B2M-02	ATOLON	INDELUZ	90	757C-L3120B-01	KALE	INDELUZ	228
738R-L3117B2M-03	ATOLON	INDELUZ	90	759A-L3142ASM-01	SINOPE	INDELUZ	100
738R-L3125B-01	ATOLON	INDELUZ	90	759A-L3142B-01	SINOPE	INDELUZ	100
738R-L3125B-02	ATOLON	INDELUZ	90	759A-L31R2B-01	SINOPE	INDELUZ	100
738R-L3125B-03	ATOLON	INDELUZ	90	759A-L3342ASM-01	SINOPE	INDELUZ	100
738R-L31R2B-01	ATOLON	INDELUZ	90	759A-L3342B-01	SINOPE	INDELUZ	100
738R-L31R2B-02	ATOLON	INDELUZ	90	759A-L33R2B-01	SINOPE	INDELUZ	100
738R-L31R2B-03	ATOLON	INDELUZ	90	759A-L4442B-01	SINOPE	INDELUZ	100
738R-L3317B2M-01	ATOLON	INDELUZ	90	759A-L4642B-01	SINOPE	INDELUZ	100
738R-L3317B2M-02	ATOLON	INDELUZ	90	759A-L4742B-01	SINOPE	INDELUZ	100
738R-L3317B2M-03	ATOLON	INDELUZ	90	759A-L4842B-01	SINOPE	INDELUZ	100
738R-L3325B-01	ATOLON	INDELUZ	90	759A-L5142B-01	SINOPE	INDELUZ	100
738R-L3325B-02	ATOLON	INDELUZ	90	772A-G18RCB-01	HAITI	INDELUZ	252
738R-L3325B-03	ATOLON	INDELUZ	90	772A-G18RCB-02	HAITI	INDELUZ	252
738R-L33R2B-01	ATOLON	INDELUZ	90	772A-G18RCB-03	HAITI	INDELUZ	252
738R-L33R2B-02	ATOLON	INDELUZ	90	772A-G21X1B-01	HAITI	INDELUZ	253
738R-L33R2B-03	ATOLON	INDELUZ	90	772A-G21X1B-02	HAITI	INDELUZ	253
741A-	MINI LUNA	INDELUZ	81	772A-G21X1B-03	HAITI	INDELUZ	253
741A-G23XID-01	MINI LUNA	INDELUZ	223	772B-G18RCB-01	HAITI	INDELUZ	252
741A-G23XID-02	MINI LUNA	INDELUZ	223	772B-G18RCB-02	HAITI	INDELUZ	252
741A-G23XID-03	MINI LUNA	INDELUZ	223	772B-G18RCB-03	HAITI	INDELUZ	252
741A-G23XID-32	MINI LUNA	INDELUZ	223	772B-G21X1B-01	HAITI	INDELUZ	253
741A-G23XID-45	MINI LUNA	INDELUZ	223	772B-G21X1B-02	HAITI	INDELUZ	253
741A-G23XID-48	MINI LUNA	INDELUZ	223	772B-G21X1B-03	HAITI	INDELUZ	253
741A-G42X1B-01	MINI LUNA	INDELUZ	223	772B-H18RCB-01	HAITI	INDELUZ	252
741A-G42X1B-02	MINI LUNA	INDELUZ	223	772B-H18RCB-02	HAITI	INDELUZ	252
741A-G42X1B-03	MINI LUNA	INDELUZ	223	772B-H18RCB-03	HAITI	INDELUZ	252
741A-G42X1B-32	MINI LUNA	INDELUZ	223	772L-L3125B-01	HAITI	INDELUZ	156



REF.	FAM.	BRAND	PAG.
772L-L3125B-02	HAITI	INDELUZ	156
772L-L3125B-03	HAITI	INDELUZ	156
772L-L31RDB-01	HAITI	INDELUZ	156
772L-L31RDB-02	HAITI	INDELUZ	156
772L-L31RDB-03	HAITI	INDELUZ	156
772L-L3325B-01	HAITI	INDELUZ	156
772L-L3325B-02	HAITI	INDELUZ	156
772L-L3325B-03	HAITI	INDELUZ	156
772L-L33RDB-01	HAITI	INDELUZ	156
772L-L33RDB-02	HAITI	INDELUZ	156
772L-L33RDB-03	HAITI	INDELUZ	156
772M-L3125B-01	HAITI	INDELUZ	156
772M-L3125B-02	HAITI	INDELUZ	156
772M-L3125B-03	HAITI	INDELUZ	156
772M-L31RDB-01	HAITI	INDELUZ	156
772M-L31RDB-02	HAITI	INDELUZ	156
772M-L31RDB-03	HAITI	INDELUZ	156
772M-L3325B-01	HAITI	INDELUZ	156
772M-L3325B-02	HAITI	INDELUZ	156
772M-L3325B-03	HAITI	INDELUZ	156
772M-L33RDB-01	HAITI	INDELUZ	156
772M-L33RDB-02	HAITI	INDELUZ	156
772M-L33RDB-03	HAITI	INDELUZ	156
772Q-L3117B1M-01	HAITI	INDELUZ	157
772Q-L3117B1M-02	HAITI	INDELUZ	157
772Q-L3117B1M-03	HAITI	INDELUZ	157
772Q-L3125B-01	HAITI	INDELUZ	157
772Q-L3125B-02	HAITI	INDELUZ	157
772Q-L3125B-03	HAITI	INDELUZ	157
772Q-L3317B1M-01	HAITI	INDELUZ	157
772Q-L3317B1M-02	HAITI	INDELUZ	157
772Q-L3317B1M-03	HAITI	INDELUZ	157
772Q-L3325B-01	HAITI	INDELUZ	157
772Q-L3325B-02	HAITI	INDELUZ	157
772Q-L3325B-03	HAITI	INDELUZ	157
772R-L3117B2M-01	HAITI	INDELUZ	157
772R-L3117B2M-02	HAITI	INDELUZ	157
772R-L3117B2M-03	HAITI	INDELUZ	157
772R-L3125B-01	HAITI	INDELUZ	157
772R-L3125B-02	HAITI	INDELUZ	157
772R-L3125B-03	HAITI	INDELUZ	157
772R-L3317B2M-01	HAITI	INDELUZ	157
772R-L3317B2M-02	HAITI	INDELUZ	157
772R-L3317B2M-03	HAITI	INDELUZ	157
772R-L3325B-01	HAITI	INDELUZ	157
772R-L3325B-02	HAITI	INDELUZ	157
772R-L3325B-03	HAITI	INDELUZ	157
780A-	NIX	INDELUZ	83
780A-G23X1D-01	NIX	INDELUZ	224
780A-G23X1D-02	NIX	INDELUZ	224
780A-G23X1D-45	NIX	INDELUZ	224
780A-G23X1D-48	NIX	INDELUZ	224
780A-G42X1B-01	NIX	INDELUZ	224
780A-G42X1B-02	NIX	INDELUZ	224
780A-G42X1B-45	NIX	INDELUZ	224
780A-G42X1B-48	NIX	INDELUZ	224
780B-	NIX	INDELUZ	83
780B-G23X1D-01	NIX	INDELUZ	224
780B-G23X1D-02	NIX	INDELUZ	224
780B-G23X1D-45	NIX	INDELUZ	224
780B-G23X1D-48	NIX	INDELUZ	224
780B-G42X1B-01	NIX	INDELUZ	224

REF.	FAM.	BRAND	PAG.
780B-G42X1B-02	NIX	INDELUZ	224
780B-G42X1B-45	NIX	INDELUZ	224
780B-G42X1B-48	NIX	INDELUZ	224
780C-L3108B-01	NIX	INDELUZ	225
780D-L3108B-01	NIX	INDELUZ	225
780E-	NIX	INDELUZ	83
780E-G23X1D-01	NIX	INDELUZ	224
780E-G23X1D-02	NIX	INDELUZ	224
780E-G23X1D-45	NIX	INDELUZ	224
780E-G23X1D-48	NIX	INDELUZ	224
780E-G42X1B-01	NIX	INDELUZ	224
780E-G42X1B-02	NIX	INDELUZ	224
780E-G42X1B-45	NIX	INDELUZ	224
780E-G42X1B-48	NIX	INDELUZ	224
780F-	NIX	INDELUZ	83
780F-G23X1D-01	NIX	INDELUZ	224
780F-G23X1D-02	NIX	INDELUZ	224
780F-G23X1D-45	NIX	INDELUZ	224
780F-G23X1D-48	NIX	INDELUZ	224
780F-G42X1B-01	NIX	INDELUZ	224
780F-G42X1B-02	NIX	INDELUZ	224
780F-G42X1B-45	NIX	INDELUZ	224
780F-G42X1B-48	NIX	INDELUZ	224
780G-L3108B-01	NIX	INDELUZ	225
780H-L3108B-01	NIX	INDELUZ	225
781B-	CARPO	INDELUZ	79
781B-G23X1D-01	CARPO	INDELUZ	226
781B-G42X1B-01	CARPO	INDELUZ	226
782A-G23X1D-01	JANUS	INDELUZ	230
782A-G23X1D-03	JANUS	INDELUZ	230
782A-G42X1B-01	JANUS	INDELUZ	230
782A-G42X1B-03	JANUS	INDELUZ	230
783A-L3145ABM-01	MAB	INDELUZ	95
783A-L3145B-01	MAB	INDELUZ	95
783A-L31R2B-01	MAB	INDELUZ	95
783A-L3345ABM-01	MAB	INDELUZ	95
783A-L3345B-01	MAB	INDELUZ	95
783A-L33R2B-01	MAB	INDELUZ	95
790A-L0106A-01	NUMBER	DOPO	470
791A-L0112A-04	ARLEN	DOPO	457
791B-L0112A-04	ARLEN	DOPO	550
792A-L0115A-30	ADGO	DOPO	508
793A-G21X1A-01	ESTEL	DOPO	478
793A-G21X1A-02	ESTEL	DOPO	478
793A-G21X1A-03	ESTEL	DOPO	478
796A-L3110I-01	DUBE	INDELUZ	144
796A-L3110I-02	DUBE	INDELUZ	144
796B-L3110I-01	DUBE	INDELUZ	144
796B-L3110I-02	DUBE	INDELUZ	144
798A-	LEN	INDELUZ	89
798A-G21X1B-01	LEN	INDELUZ	220
798B-	LEN	INDELUZ	89
798B-G21X1B-01	LEN	INDELUZ	220
798C-	LEN	INDELUZ	89
798C-G21X1B-01	LEN	INDELUZ	220
801A-L3148B-01	BILOG	INDELUZ	92
801A-L3148B-02	BILOG	INDELUZ	92
801A-L31RDB-01	BILOG	INDELUZ	92
801A-L31RDB-02	BILOG	INDELUZ	92
801A-L3348B-01	BILOG	INDELUZ	92
801A-L3348B-02	BILOG	INDELUZ	92
801A-L33RDB-01	BILOG	INDELUZ	92



REF.	FAM.	BRAND	PAG.	REF.	FAM.	BRAND	PAG.
801A-L33RDB-02	BILOG	INDELUZ	92	809A-L3344B-03	SIGMA	INDELUZ	122
801B-L31A3B-01	BILOG	INDELUZ	93	809A-L33RDB-01	SIGMA	INDELUZ	122
801B-L31A3B-02	BILOG	INDELUZ	93	809A-L33RDB-03	SIGMA	INDELUZ	122
801B-L31RDB-01	BILOG	INDELUZ	93	809A-L3844B-01	SIGMA	INDELUZ	122
801B-L31RDB-02	BILOG	INDELUZ	93	809A-L3844B-03	SIGMA	INDELUZ	122
801B-L33A3B-01	BILOG	INDELUZ	93	809A-L38RDB-01	SIGMA	INDELUZ	122
801B-L33A3B-02	BILOG	INDELUZ	93	809A-L38RDB-03	SIGMA	INDELUZ	122
801B-L33RDB-01	BILOG	INDELUZ	93	809B-L3157B-01	SIGMA	INDELUZ	122
801B-L33RDB-02	BILOG	INDELUZ	93	809B-L3157B-03	SIGMA	INDELUZ	122
801C-L3148B-01	BILOG	INDELUZ	92	809B-L31RDB-01	SIGMA	INDELUZ	122
801C-L3148B-02	BILOG	INDELUZ	92	809B-L31RDB-03	SIGMA	INDELUZ	122
801C-L31RDB-01	BILOG	INDELUZ	92	809B-L3357B-01	SIGMA	INDELUZ	122
801C-L31RDB-02	BILOG	INDELUZ	92	809B-L3357B-03	SIGMA	INDELUZ	122
801C-L3348B-01	BILOG	INDELUZ	92	809B-L33RDB-01	SIGMA	INDELUZ	122
801C-L3348B-02	BILOG	INDELUZ	92	809B-L33RDB-03	SIGMA	INDELUZ	122
801C-L33RDB-01	BILOG	INDELUZ	92	809B-L3857B-01	SIGMA	INDELUZ	122
801C-L33RDB-02	BILOG	INDELUZ	92	809B-L3857B-03	SIGMA	INDELUZ	122
801D-L31A3B-01	BILOG	INDELUZ	93	809B-L38RDB-01	SIGMA	INDELUZ	122
801D-L31A3B-02	BILOG	INDELUZ	93	809B-L38RDB-03	SIGMA	INDELUZ	122
801D-L31RDB-01	BILOG	INDELUZ	93	809C-L3106B-01	SIGMA	INDELUZ	118
801D-L31RDB-02	BILOG	INDELUZ	93	809C-L3106B-03	SIGMA	INDELUZ	118
801D-L33A3B-01	BILOG	INDELUZ	93	809C-L3106B4M-01	SIGMA	INDELUZ	118
801D-L33A3B-02	BILOG	INDELUZ	93	809C-L3106B4M-03	SIGMA	INDELUZ	118
801D-L33RDB-01	BILOG	INDELUZ	93	809C-L3306B-01	SIGMA	INDELUZ	118
801D-L33RDB-02	BILOG	INDELUZ	93	809C-L3306B-03	SIGMA	INDELUZ	118
803A-L3135B-01	ENIGMA	INDELUZ	153	809C-L3306B4M-01	SIGMA	INDELUZ	118
803A-L3135B-02	ENIGMA	INDELUZ	153	809C-L3306B4M-03	SIGMA	INDELUZ	118
803A-L3335B-01	ENIGMA	INDELUZ	153	809C-L3806B-01	SIGMA	INDELUZ	118
803A-L3335B-02	ENIGMA	INDELUZ	153	809C-L3806B-03	SIGMA	INDELUZ	118
803B-L4125B6F-01	ENIGMA	INDELUZ	152	809C-L3806B4M-01	SIGMA	INDELUZ	118
803B-L4125B6F-02	ENIGMA	INDELUZ	152	809C-L3806B4M-03	SIGMA	INDELUZ	118
804A-L3142A9M-01	SPLAT	INDELUZ	97	809D-L3113B-01	SIGMA	INDELUZ	118
804A-L3142B-01	SPLAT	INDELUZ	97	809D-L3113B-03	SIGMA	INDELUZ	118
804A-L31RDB-01	SPLAT	INDELUZ	97	809D-L3113B4M-01	SIGMA	INDELUZ	118
804A-L3342A9M-01	SPLAT	INDELUZ	97	809D-L3113B4M-03	SIGMA	INDELUZ	118
804A-L3342B-01	SPLAT	INDELUZ	97	809D-L3313B-01	SIGMA	INDELUZ	118
804A-L33RDB-01	SPLAT	INDELUZ	97	809D-L3313B-03	SIGMA	INDELUZ	118
805A-L3115B-01	BUIS	INDELUZ	101	809D-L3313B4M-01	SIGMA	INDELUZ	118
805A-L3115B-03	BUIS	INDELUZ	101	809D-L3313B4M-03	SIGMA	INDELUZ	118
805A-L3315B-01	BUIS	INDELUZ	101	809D-L3813B-01	SIGMA	INDELUZ	118
805A-L3315B-03	BUIS	INDELUZ	101	809D-L3813B-03	SIGMA	INDELUZ	118
805B-L3125B-01	BUIS	INDELUZ	101	809D-L3813B4M-01	SIGMA	INDELUZ	118
805B-L3125B-03	BUIS	INDELUZ	101	809D-L3813B4M-03	SIGMA	INDELUZ	118
805B-L3325B-01	BUIS	INDELUZ	101	809E-L3125B-01	SIGMA	INDELUZ	118
805B-L3325B-03	BUIS	INDELUZ	101	809E-L3125B-03	SIGMA	INDELUZ	118
805C-L3135B-01	BUIS	INDELUZ	101	809E-L3125B4M-01	SIGMA	INDELUZ	118
805C-L3135B-03	BUIS	INDELUZ	101	809E-L3125B4M-03	SIGMA	INDELUZ	118
805C-L3335B-01	BUIS	INDELUZ	101	809E-L31RDB-01	SIGMA	INDELUZ	118
805C-L3335B-03	BUIS	INDELUZ	101	809E-L31RDB-03	SIGMA	INDELUZ	118
806A-L3118R-01	VALGUS	INDELUZ	99	809E-L3325B-01	SIGMA	INDELUZ	118
806A-L3118Z-01	VALGUS	INDELUZ	99	809E-L3325B-03	SIGMA	INDELUZ	118
806A-L31RCA-01	VALGUS	INDELUZ	99	809E-L3325B4M-01	SIGMA	INDELUZ	118
806A-L3318R-01	VALGUS	INDELUZ	99	809E-L3325B4M-03	SIGMA	INDELUZ	118
806A-L3318Z-01	VALGUS	INDELUZ	99	809E-L33RDB-01	SIGMA	INDELUZ	118
806A-L33RCA-01	VALGUS	INDELUZ	99	809E-L33RDB-03	SIGMA	INDELUZ	118
806B-L31RCB-01	VALGUS	INDELUZ	99	809E-L3825B-01	SIGMA	INDELUZ	118
806B-L33RCB-01	VALGUS	INDELUZ	99	809E-L3825B-03	SIGMA	INDELUZ	118
809A-L3144B-01	SIGMA	INDELUZ	122	809E-L3825B4M-01	SIGMA	INDELUZ	118
809A-L3144B-03	SIGMA	INDELUZ	122	809E-L3825B4M-03	SIGMA	INDELUZ	118
809A-L31RDB-01	SIGMA	INDELUZ	122	809E-L38RDB-01	SIGMA	INDELUZ	118
809A-L31RDB-03	SIGMA	INDELUZ	122	809E-L38RDB-03	SIGMA	INDELUZ	118
809A-L3344B-01	SIGMA	INDELUZ	122	809F-L3106B-01	SIGMA	INDELUZ	120

REF.	FAM.	BRAND	PAG.
809F-L3106B-03	SIGMA	INDELUZ	120
809F-L3106B4M-01	SIGMA	INDELUZ	120
809F-L3106B4M-03	SIGMA	INDELUZ	120
809F-L3306B-01	SIGMA	INDELUZ	120
809F-L3306B-03	SIGMA	INDELUZ	120
809F-L3306B4M-01	SIGMA	INDELUZ	120
809F-L3306B4M-03	SIGMA	INDELUZ	120
809F-L3806B-01	SIGMA	INDELUZ	120
809F-L3806B-03	SIGMA	INDELUZ	120
809F-L3806B4M-01	SIGMA	INDELUZ	120
809F-L3806B4M-03	SIGMA	INDELUZ	120
809G-L3113B-01	SIGMA	INDELUZ	120
809G-L3113B-03	SIGMA	INDELUZ	120
809G-L3113B4M-01	SIGMA	INDELUZ	120
809G-L3113B4M-03	SIGMA	INDELUZ	120
809G-L3313B-01	SIGMA	INDELUZ	120
809G-L3313B-03	SIGMA	INDELUZ	120
809G-L3313B4M-01	SIGMA	INDELUZ	120
809G-L3313B4M-03	SIGMA	INDELUZ	120
809G-L3813B-01	SIGMA	INDELUZ	120
809G-L3813B-03	SIGMA	INDELUZ	120
809G-L3813B4M-01	SIGMA	INDELUZ	120
809G-L3813B4M-03	SIGMA	INDELUZ	120
809H-L3125B-01	SIGMA	INDELUZ	120
809H-L3125B-03	SIGMA	INDELUZ	120
809H-L3125B4M-01	SIGMA	INDELUZ	120
809H-L3125B4M-03	SIGMA	INDELUZ	120
809H-L31RDB-01	SIGMA	INDELUZ	120
809H-L31RDB-03	SIGMA	INDELUZ	120
809H-L3325B-01	SIGMA	INDELUZ	120
809H-L3325B-03	SIGMA	INDELUZ	120
809H-L3325B4M-01	SIGMA	INDELUZ	120
809H-L3325B4M-03	SIGMA	INDELUZ	120
809H-L33RDB-01	SIGMA	INDELUZ	120
809H-L33RDB-03	SIGMA	INDELUZ	120
809H-L3825B-01	SIGMA	INDELUZ	120
809H-L3825B-03	SIGMA	INDELUZ	120
809H-L3825B4M-01	SIGMA	INDELUZ	120
809H-L3825B4M-03	SIGMA	INDELUZ	120
809H-L38RDB-01	SIGMA	INDELUZ	120
809H-L38RDB-03	SIGMA	INDELUZ	120
816A-L3106B-01	PEGASO	INDELUZ	221
818B-L3108B-01	JANO	INDELUZ	221
825Q-L3135B-01	LAND	INDELUZ	155
825Q-L3135B-02	LAND	INDELUZ	155
825Q-L3335B-01	LAND	INDELUZ	155
825Q-L3335B-02	LAND	INDELUZ	155
825Q-L3835B-01	LAND	INDELUZ	155
825Q-L3835B-02	LAND	INDELUZ	155
825R-L3135B-01	LAND	INDELUZ	155
825R-L3135B-02	LAND	INDELUZ	155
825R-L3335B-01	LAND	INDELUZ	155
825R-L3335B-02	LAND	INDELUZ	155
825R-L3835B-01	LAND	INDELUZ	155
825R-L3835B-02	LAND	INDELUZ	155
825S-L3135B-01	LAND	INDELUZ	155
825S-L3135B-02	LAND	INDELUZ	155
825S-L3335B-01	LAND	INDELUZ	155
825S-L3335B-02	LAND	INDELUZ	155
825S-L3835B-01	LAND	INDELUZ	155
825S-L3835B-02	LAND	INDELUZ	155
832B-L3121B-01	HIDRA	INDELUZ	148

REF.	FAM.	BRAND	PAG.
832C-L3121B-01	HIDRA	INDELUZ	148
832D-L3121B-01	HIDRA	INDELUZ	148
833B-L3121B-01	HIDRA	INDELUZ	149
833C-L3121B-01	HIDRA	INDELUZ	149
833D-L3121B-01	HIDRA	INDELUZ	149
834B-L3121B-01	HIDRA	INDELUZ	148
834C-L3121B-01	HIDRA	INDELUZ	148
834D-L3121B-01	HIDRA	INDELUZ	148
836B-L3121B-01	HIDRA	INDELUZ	149
836C-L3121B-01	HIDRA	INDELUZ	149
836D-L3121B-01	HIDRA	INDELUZ	149
842A-L0103B-01	TOSCANA	EXO	299
842A-L0103B-02	TOSCANA	EXO	299
842A-L0103B-35	TOSCANA	EXO	299
844A-G05X1A-01	VALAN	EXO	341
844A-G05X1A-BL	VALAN	EXO	341
844A-G05X1A-MK	VALAN	EXO	341
845A-G05X1A-50	LARS	EXO	405
845B-G05X1A-50	LARS	EXO	405
846B-G05X1A-01	VALAN	EXO	287
846B-G05X1A-BL	VALAN	EXO	287
846B-G05X1A-MK	VALAN	EXO	287
846C-G05X1A-01	VALAN	EXO	415
846C-G05X1A-BL	VALAN	EXO	415
846C-G05X1A-MK	VALAN	EXO	415
846D-G05X1A-01	VALAN	EXO	415
846D-G05X1A-BL	VALAN	EXO	415
846D-G05X1A-MK	VALAN	EXO	415
847A-L0107B-01	ABAR	DOPO	471
847A-L0107B-02	ABAR	DOPO	471
847A-L0107B-04	ABAR	DOPO	471
848A-L0109A-04	ADAY	DOPO	455
848B-L0118A-04	ADAY	DOPO	549
848C-L0118A-04	ADAY	DOPO	549
851A-L3110B-04	NAGORE	DOPO	518
851B-L3110B-04	NAGORE	DOPO	518
853A-L01X1K-04	SOLEI	DOPO	571
853B-L01X1K-04	SOLEI	DOPO	571
854A-L0104A-01	LARA	DOPO	495
854A-L0104A-04	LARA	DOPO	495
854B-L0104A-01	LARA	DOPO	495
854B-L0104A-04	LARA	DOPO	495
855A-G05X1A-01-SA	DIAGONAL	EXO	391
855A-G05X1A-02-SB	DIAGONAL	EXO	391
855A-G05X1A-37-SM	DIAGONAL	EXO	391
855B-G05X1A-01-SA	DIAGONAL	EXO	390
855B-G05X1A-02-SB	DIAGONAL	EXO	390
855B-G05X1A-37-SM	DIAGONAL	EXO	390
855C-G05X1A-01-SA	DIAGONAL	EXO	390
855C-G05X1A-02-SB	DIAGONAL	EXO	390
855C-G05X1A-37-SM	DIAGONAL	EXO	390
855D-G05X1A-01-SA	DIAGONAL	EXO	340
855D-G05X1A-02-SB	DIAGONAL	EXO	340
855D-G05X1A-37-SM	DIAGONAL	EXO	340
855E-G05X1A-01-SA	DIAGONAL	EXO	277
855E-G05X1A-02-SB	DIAGONAL	EXO	277
855E-G05X1A-37-SM	DIAGONAL	EXO	277
857A-G05X1A-58	NELL	CRISTHER	767
857B-G05X1A-58	NELL	CRISTHER	767
857C-L3102L-58	NELL	CRISTHER	767
857C-L3106B-58	NELL	CRISTHER	767
857D-G05X1A-58	NELL	CRISTHER	766

REF.	FAM.	BRAND	PAG.	REF.	FAM.	BRAND	PAG.
857H-L3106B-58	NELL	CRISTHER	766	908B-L0125B-RC	VORADA	EXO	354
858A-G05X1B-02	PORTOFINO	DOPO	581	908C-L0129B-RA	VORADA	EXO	354
858A-K12-632H-01	PORTOFINO	DOPO	581	908C-L0129B-RB	VORADA	EXO	354
858A-K12-632J-01	PORTOFINO	DOPO	581	908C-L0129B-RC	VORADA	EXO	354
858AK-632H-01	PORTOFINO	DOPO	581	908D-L0112B-RA	VORADA	EXO	355
858AK-632J-01	PORTOFINO	DOPO	581	908D-L0112B-RB	VORADA	EXO	355
859A-G05X1A-35-RA	CORA	EXO	352	908D-L0112B-RC	VORADA	EXO	355
859A-G05X1A-35-RB	CORA	EXO	352	908E-L0125B-RA	VORADA	EXO	355
859A-G05X1A-35-RC	CORA	EXO	352	908E-L0125B-RB	VORADA	EXO	355
859B-G05X1A-01-RA	CORA	EXO	397	908E-L0125B-RC	VORADA	EXO	355
859B-G05X1A-02-RB	CORA	EXO	397	908F-L0129B-RA	VORADA	EXO	355
859C-G05X1A-01-RA	CORA	EXO	396	908F-L0129B-RB	VORADA	EXO	355
859C-G05X1A-02-RB	CORA	EXO	396	908F-L0129B-RC	VORADA	EXO	355
859D-G05X1A-01-RA	CORA	EXO	280	908G-G05X1A-35-RA	AMSTERDAM	EXO	279
859D-G05X1A-02-RB	CORA	EXO	280	908G-G05X1A-35-RB	AMSTERDAM	EXO	279
906A-G21X1A-01	TANIA	EXO	274	908G-G05X1A-35-RC	AMSTERDAM	EXO	279
906A-G21X1A-02	TANIA	EXO	274	909A-G05X1A-01	AMSTERDAM	EXO	395
906A-G21X1A-37	TANIA	EXO	274	909A-G05X1A-02	AMSTERDAM	EXO	395
906A-G21X1A-47	TANIA	EXO	274	909B-G05X1A-01	AMSTERDAM	EXO	394
906B-G21X1A-01	TANIA	EXO	337	909B-G05X1A-02	AMSTERDAM	EXO	394
906B-G21X1A-02	TANIA	EXO	337	909C-G05X1A-35-CA	AMSTERDAM	EXO	279
906B-G21X1A-37	TANIA	EXO	337	909C-G05X1A-35-CB	AMSTERDAM	EXO	279
906B-G21X1A-47	TANIA	EXO	337	909C-G05X1A-35-CG	AMSTERDAM	EXO	279
906C-G21X1A-01	TANIA	EXO	337	911A-L0118A-04	BLED	DOPO	578
906C-G21X1A-02	TANIA	EXO	337	911B-L0108L-01	BLED	DOPO	579
906C-G21X1A-37	TANIA	EXO	337	912A-L0101F-30	BERNA	DOPO	504
906C-G21X1A-47	TANIA	EXO	337	914A-L0103L-01	LITTA	DOPO	575
906D-L31H1B-01	TANIA	EXO	275	914A-L0103L-02	LITTA	DOPO	575
906D-L31H1B-02	TANIA	EXO	275	914A-L0103L-90	LITTA	DOPO	575
906D-L31H1B-37	TANIA	EXO	275	914B-L0103L-01	LITTA	DOPO	575
906D-L31H1B-47	TANIA	EXO	275	914B-L0103L-02	LITTA	DOPO	575
906E-L3104B-01	TANIA	EXO	339	916A-L0103K-04	COMO	DOPO	569
906E-L3104B-02	TANIA	EXO	339	916B-L0103K-04	COMO	DOPO	568
906E-L3104B-37	TANIA	EXO	339	916C-L0103K-04	COMO	DOPO	569
906E-L3104B-47	TANIA	EXO	339	917A-G05X1A-02-CA	SINTRA	EXO	412
906F-L3104B-01	TANIA	EXO	339	917B-G05X1A-02-CA	SINTRA	EXO	412
906F-L3104B-02	TANIA	EXO	339	918A-L0103L-04	ERICE	DOPO	577
906F-L3104B-37	TANIA	EXO	339	920A-L1440F-03	WALK RGB	CRISTHER	701
906F-L3104B-47	TANIA	EXO	339	920A-L3122B-03	WALK	CRISTHER	700
906G-L3104B-01	TANIA	EXO	385	920A-L3322B-03	WALK	CRISTHER	700
906G-L3104B-02	TANIA	EXO	385	920B-L3122B-03	WALK	CRISTHER	700
906G-L3104B-37	TANIA	EXO	385	920B-L3322B-03	WALK	CRISTHER	700
906G-L3104B-47	TANIA	EXO	385	920C-L1480F-03	WALK RGB	CRISTHER	701
906H-G21X1A-01	TANIA	EXO	335	920C-L3147B-03	WALK	CRISTHER	700
906H-G21X1A-02	TANIA	EXO	335	920C-L3347B-03	WALK	CRISTHER	700
906H-G21X1A-37	TANIA	EXO	335	920D-L3147B-03	WALK	CRISTHER	700
906H-G21X1A-47	TANIA	EXO	335	920D-L3347B-03	WALK	CRISTHER	700
906J-G21X1A-01	TANIA	EXO	335	920G-L3112B-30	WALK	CRISTHER	702
906J-G21X1A-02	TANIA	EXO	335	920G-L3312B-30	WALK	CRISTHER	702
906J-G21X1A-37	TANIA	EXO	335	920H-L3124B-30	WALK	CRISTHER	702
906J-G21X1A-47	TANIA	EXO	335	920H-L3324B-30	WALK	CRISTHER	702
906K-G21X1A-01	TANIA	EXO	335	920M-L1440F-30	WALK RGB	CRISTHER	703
906K-G21X1A-02	TANIA	EXO	335	920M-L3122B-30	WALK	CRISTHER	702
906K-G21X1A-37	TANIA	EXO	335	920M-L3322B-30	WALK	CRISTHER	702
906K-G21X1A-47	TANIA	EXO	335	920N-L3122B-30	WALK	CRISTHER	702
907A-G05X1A-02-CB	MONTECARLO	EXO	417	920N-L3322B-30	WALK	CRISTHER	702
907B-G05X1A-02-CB	MONTECARLO	EXO	288	920O-L1480F-30	WALK RGB	CRISTHER	703
908A-L0112B-RA	VORADA	EXO	354	920O-L3147B-30	WALK	CRISTHER	702
908A-L0112B-RB	VORADA	EXO	354	920O-L3347B-30	WALK	CRISTHER	702
908A-L0112B-RC	VORADA	EXO	354	920P-L3147B-30	WALK	CRISTHER	702
908B-L0125B-RA	VORADA	EXO	354	920P-L3347B-30	WALK	CRISTHER	702
908B-L0125B-RB	VORADA	EXO	354	922A-L3108B-04	DADO	CRISTHER	718

REF.	FAM.	BRAND	PAG.
922A-L3308B-04	DADO	CRISTHER	718
922B-L3108B-04	DADO	CRISTHER	718
922B-L3308B-04	DADO	CRISTHER	718
922C-L3114B-04	DADO	CRISTHER	719
922C-L31RDB-04	DADO	CRISTHER	719
922C-L3314B-04	DADO	CRISTHER	719
922C-L33RDB-04	DADO	CRISTHER	719
922D-L3114B-04	DADO	CRISTHER	719
922D-L31RDB-04	DADO	CRISTHER	719
922D-L3314B-04	DADO	CRISTHER	719
922D-L33RDB-04	DADO	CRISTHER	719
923A-L3113B-04	RIMA	CRISTHER	660
923A-L3313B-04	RIMA	CRISTHER	660
923B-L3105B-04	RIMA	CRISTHER	660
923B-L3305B-04	RIMA	CRISTHER	660
926A-L3109B-80	DION	CRISTHER	737
926A-L3109B-81	DION	CRISTHER	737
926A-L3109B-82	DION	CRISTHER	737
926A-L3109B-83	DION	CRISTHER	737
926B-L3109B-80	DION	CRISTHER	737
926B-L3109B-81	DION	CRISTHER	737
926B-L3109B-82	DION	CRISTHER	737
926B-L3109B-83	DION	CRISTHER	737
926C-L3109B-80	DION	CRISTHER	737
926C-L3109B-81	DION	CRISTHER	737
926C-L3109B-82	DION	CRISTHER	737
926C-L3109B-83	DION	CRISTHER	737
926D-L3109B-80	DION	CRISTHER	641
926D-L3109B-81	DION	CRISTHER	641
926D-L3109B-82	DION	CRISTHER	641
926D-L3109B-83	DION	CRISTHER	641
928A-L3126B-04	TINA	CRISTHER	725
928A-L3326B-04	TINA	CRISTHER	725
928B-L3126B-04	TINA	CRISTHER	725
928B-L3326B-04	TINA	CRISTHER	725
928C-L3126B-04	TINA	CRISTHER	725
928C-L3326B-04	TINA	CRISTHER	725
928D-L3126B-04	TINA	CRISTHER	725
928D-L3326B-04	TINA	CRISTHER	725
928E-L3126B-04	TINA	CRISTHER	725
928E-L3326B-04	TINA	CRISTHER	725
928F-L3126B-04	TINA	CRISTHER	725
928F-L3326B-04	TINA	CRISTHER	725
929A-L3109B-01	DAIN	CRISTHER	646
929A-L3109B-02	DAIN	CRISTHER	646
929A-L3109B-03	DAIN	CRISTHER	646
929A-L3109B-90	DAIN	CRISTHER	646
929B-L3105B-01	DAIN	CRISTHER	646
929B-L3105B-02	DAIN	CRISTHER	646
929B-L3105B-03	DAIN	CRISTHER	646
929B-L3105B-90	DAIN	CRISTHER	646
929C-L3105B-02	DAIN	CRISTHER	739
929C-L3105B-03	DAIN	CRISTHER	739
929C-L3105B-90	DAIN	CRISTHER	739
929D-L3105B-02	DAIN	CRISTHER	739
929D-L3105B-03	DAIN	CRISTHER	739
929D-L3105B-90	DAIN	CRISTHER	739
930A-L3130B-02	HAMELIN	CRISTHER	715
930A-L3130B-03	HAMELIN	CRISTHER	715
930A-L3330B-02	HAMELIN	CRISTHER	715
930A-L3330B-03	HAMELIN	CRISTHER	715
931A-L3117B-04	HERA	CRISTHER	648

REF.	FAM.	BRAND	PAG.
931A-L3117B-90	HERA	CRISTHER	648
931A-L31RDB-04	HERA	CRISTHER	648
931A-L31RDB-90	HERA	CRISTHER	648
931A-L3317B-04	HERA	CRISTHER	648
931A-L3317B-90	HERA	CRISTHER	648
931A-L33RDB-04	HERA	CRISTHER	648
931A-L33RDB-90	HERA	CRISTHER	648
932A-L3133B-02	AURA	CRISTHER	742
932A-L3133B-90	AURA	CRISTHER	742
932A-L31RDB-02	AURA	CRISTHER	742
932A-L31RDB-90	AURA	CRISTHER	742
932A-L3333B-02	AURA	CRISTHER	742
932A-L3333B-90	AURA	CRISTHER	742
932A-L33RDB-02	AURA	CRISTHER	742
932A-L33RDB-90	AURA	CRISTHER	742
932B-L3133B-02	AURA	CRISTHER	743
932B-L3133B-90	AURA	CRISTHER	743
932B-L31RDB-02	AURA	CRISTHER	743
932B-L31RDB-90	AURA	CRISTHER	743
932B-L3333B-02	AURA	CRISTHER	743
932B-L3333B-90	AURA	CRISTHER	743
932B-L33RDB-02	AURA	CRISTHER	743
932B-L33RDB-90	AURA	CRISTHER	743
932C-L3114B-02	AURA	CRISTHER	742
932C-L3114B-90	AURA	CRISTHER	742
932C-L31RDB-02	AURA	CRISTHER	742
932C-L31RDB-90	AURA	CRISTHER	742
932C-L3314B-02	AURA	CRISTHER	742
932C-L3314B-90	AURA	CRISTHER	742
932C-L33RDB-02	AURA	CRISTHER	742
932C-L33RDB-90	AURA	CRISTHER	742
932D-L3125B-02	AURA	CRISTHER	742
932D-L3125B-90	AURA	CRISTHER	742
932D-L31RDB-02	AURA	CRISTHER	742
932D-L31RDB-90	AURA	CRISTHER	742
932D-L3325B-02	AURA	CRISTHER	742
932D-L3325B-90	AURA	CRISTHER	742
932D-L33RDB-02	AURA	CRISTHER	742
932D-L33RDB-90	AURA	CRISTHER	742
934A-L3102L-01	BLOMMA	DOPO	576
935A-L3105B-02	ARM	EXO	289
935B-L3105B-02	ARM	EXO	289
940B-L3340B-01	CROUS	INDELUZ	241
940B-L3640B-01	CROUS	INDELUZ	241
940D-L3340B-01	CROUS	INDELUZ	241
940D-L3640B-01	CROUS	INDELUZ	241
940E-L3350B-01	CROUS	INDELUZ	241
940E-L3650B-01	CROUS	INDELUZ	241
940F-L3350B-01	CROUS	INDELUZ	241
940F-L3650B-01	CROUS	INDELUZ	241
941A-L0106A-04	ODIN	DOPO	553
941B-L0106A-04	ODIN	DOPO	553
945A-L3110A-50	TWIST	EXO	379
945B-L3111A-50	TWIST	EXO	379
945C-L3110A-50	TWIST	EXO	321
945D-L3110A-50	TWIST	EXO	321
945E-L3111A-50	TWIST	EXO	379
947A-L3104A-01	STORM	DOPO	479
947A-L3104A-02	STORM	DOPO	479
947A-L3104A-03	STORM	DOPO	479
947B-L3109A-01	STORM	DOPO	479
947B-L3109A-02	STORM	DOPO	479

REF.	FAM.	BRAND	PAG.	REF.	FAM.	BRAND	PAG.
947B-L3109A-03	STORM	DOPO	479	962C-L3114B-02-W1	EYE	EXO	269
947C-L3111A-01	STORM	DOPO	479	962C-L3114B-02-W2	EYE	EXO	269
947C-L3111A-02	STORM	DOPO	479	962C-L3114B-02-W3	EYE	EXO	269
947C-L3111A-03	STORM	DOPO	479	965A-G21X1A-NB	STONE	CRISTHER	643
948A-L3110A-01	MIST	DOPO	500	965A-G21X1A-NN	STONE	CRISTHER	643
948A-L3110A-02	MIST	DOPO	500	965A-G21X1A-NR	STONE	CRISTHER	643
948A-L3110A-03	MIST	DOPO	500	965A-G21X1A-NW	STONE	CRISTHER	643
949A-L3111A-01	WIND	DOPO	498	965B-G21X1A-NB	STONE	CRISTHER	643
949A-L3111A-02	WIND	DOPO	498	965B-G21X1A-NN	STONE	CRISTHER	643
949A-L3111A-03	WIND	DOPO	498	965B-G21X1A-NR	STONE	CRISTHER	643
950A-L1002A-01	RAIN	DOPO	513	965B-G21X1A-NW	STONE	CRISTHER	643
950A-L1002A-02	RAIN	DOPO	513	965C-L3112A-NB	STONE	CRISTHER	644
950A-L1002A-03	RAIN	DOPO	513	965C-L3112A-NN	STONE	CRISTHER	644
950A-L3102A-01	RAIN	DOPO	513	965C-L3112A-NR	STONE	CRISTHER	644
950A-L3102A-02	RAIN	DOPO	513	965C-L3112A-NW	STONE	CRISTHER	644
950A-L3102A-03	RAIN	DOPO	513	965D-G21X1A-NB	STONE	CRISTHER	673
950B-L3102A-01	RAIN	DOPO	512	965D-G21X1A-NN	STONE	CRISTHER	673
950B-L3102A-02	RAIN	DOPO	512	965D-G21X1A-NR	STONE	CRISTHER	673
950B-L3102A-03	RAIN	DOPO	512	965D-G21X1A-NW	STONE	CRISTHER	673
950C-L3102A-01	RAIN	DOPO	512	965F-L3106B-NB	STONE	CRISTHER	735
950C-L3102A-02	RAIN	DOPO	512	965F-L3106B-NN	STONE	CRISTHER	735
950C-L3102A-03	RAIN	DOPO	512	965H-G21X1A-NB	STONE	CRISTHER	713
950D-L1002A-01	RAIN	DOPO	513	965H-G21X1A-NN	STONE	CRISTHER	713
950D-L1002A-02	RAIN	DOPO	513	967A-L0102A-01	G9	NX Lighting	792
950D-L1002A-03	RAIN	DOPO	513	967A-L0102A-02	G9	NX Lighting	792
950D-L3102A-01	RAIN	DOPO	513	968A-L4104A-02	R7s	NX Lighting	792
950D-L3102A-02	RAIN	DOPO	513	968B-L4108A-02	R7s	NX Lighting	792
950D-L3102A-03	RAIN	DOPO	513	968C-L4111A-02	R7s	NX Lighting	792
951A-L3103A-04	SHINNY	DOPO	504	970A-L0206B-32	BLIZZARD	EXO	427
952A-L3107A-01	CLOUD	DOPO	460	970B-L0208B-32	BLIZZARD	EXO	427
952A-L3107A-04	CLOUD	DOPO	460	970C-L0210B-32	BLIZZARD	EXO	427
953A-L3108A-01	FROST	DOPO	460	970D-L0215B-32	BLIZZARD	EXO	427
953A-L3108A-04	FROST	DOPO	460	970E-L0218B-32	BLIZZARD	EXO	427
954A-L3106B-01	HAIL	DOPO	480	971A-L0207B-32	DEW	EXO	423
954A-L3106B-04	HAIL	DOPO	480	971B-L0209B-32	DEW	EXO	423
955A-L0102A-01	SKIN	EXO	295	971C-L0210B-32	DEW	EXO	423
955A-L0102A-02	SKIN	EXO	295	972A-L4106B-32	SLEET	EXO	425
955A-L0102A-07	SKIN	EXO	295	972B-L4108B-32	SLEET	EXO	425
955A-L0102A-14	SKIN	EXO	295	972C-L4112B-32	SLEET	EXO	425
956A-G05X1A-01	TOSCA	EXO	333	972D-L4106B-32	SLEET	EXO	424
956A-G05X1A-02	TOSCA	EXO	333	972E-L4108B-32	SLEET	EXO	424
956A-G05X1A-06	TOSCA	EXO	333	973A-L0206B-32	ICY	EXO	420
956B-G05X1A-01	TOSCA	EXO	333	974A-L0220B-32	MINERVA	EXO	431
956B-G05X1A-02	TOSCA	EXO	333	974B-L0220B-32	MINERVA	EXO	431
956B-G05X1A-06	TOSCA	EXO	333	974C-L0220B-32	MINERVA	EXO	431
956C-G05X1A-01	TOSCA	EXO	273	974D-L0220B-32	MINERVA	EXO	431
956C-G05X1A-02	TOSCA	EXO	273	975A-L0220B-32	AFRODITA	EXO	433
956C-G05X1A-06	TOSCA	EXO	273	975B-L0220B-32	AFRODITA	EXO	433
959A-L0218B-01	TILT	EXO	421	975C-L0220B-32	AFRODITA	EXO	433
959A-L0218B-02	TILT	EXO	421	976A-L3110B-04	BUCKET	DOPO	453
959B-L0230B-01	TILT	EXO	421	976A-L3130B-04	BUCKET	DOPO	453
959B-L0230B-02	TILT	EXO	421	976A-L33RCB-04	BUCKET	DOPO	453
960A-L3106B-01	BEAM	DOPO	458	976B-L3110B-04	BUCKET	DOPO	541
960A-L3106B-02	BEAM	DOPO	458	976B-L3130B-04	BUCKET	DOPO	541
960A-L3106B-04	BEAM	DOPO	458	976B-L33RCB-04	BUCKET	DOPO	541
960A-L3106B-90	BEAM	DOPO	458	976B-L3310B-04	BUCKET	DOPO	541
962A-L3114B-02-W1	EYE	EXO	269	976B-L33RCB-04	BUCKET	DOPO	541
962A-L3114B-02-W2	EYE	EXO	269	976C-L3110B-04	BUCKET	DOPO	541
962A-L3114B-02-W3	EYE	EXO	269	976C-L3130B-04	BUCKET	DOPO	541
962B-L3114B-02-W1	EYE	EXO	269	976C-L33RCB-04	BUCKET	DOPO	541
962B-L3114B-02-W2	EYE	EXO	269	977A-L0103A-01	MINIMAL	EXO	293
962B-L3114B-02-W3	EYE	EXO	269				

REFERENCE INDEX PVP

REF.	FAM.	BRAND	PAG.
977A-L0103A-02	MINIMAL	EXO	293
977A-L0103A-02-47	MINIMAL	EXO	293
979A-L3105A-01	CALYPSO2	INDELUZ	232
979A-L3305A-01	CALYPSO2	INDELUZ	232
979B-L3112A-01	CALYPSO2	INDELUZ	232
979B-L3312A-01	CALYPSO2	INDELUZ	232
979C-L3124A-01	CALYPSO2	INDELUZ	232
979C-L3324A-01	CALYPSO2	INDELUZ	232
979D-L3130A-01	CALYPSO2	INDELUZ	232
979D-L3330A-01	CALYPSO2	INDELUZ	232
980A-L0103H-30	NABUCO	CRISTHER	677
980B-L0104H-30	NABUCO	CRISTHER	677
980B-L0106H-30	NABUCO	CRISTHER	677
980H-L0103H-30	NABUCO	CRISTHER	683
980I-L0104H-30	NABUCO	CRISTHER	683
980I-L0106H-30	NABUCO	CRISTHER	683
982A-L3109A-02	LOOP	DOPO	452
982A-L3309A-02	LOOP	DOPO	452
982B-L3109A-02	LOOP	DOPO	543
982B-L3309A-02	LOOP	DOPO	543
982C-L3109A-02	LOOP	DOPO	543
982C-L3309A-02	LOOP	DOPO	543
983A-L41MPA-01	FALL	INDELUZ	151
983A-L41MPA-02	FALL	INDELUZ	151
984A-G05X1A-02	OXY	EXO	329
984A-G05X1A-02-27	OXY	EXO	329
984A-G05X1A-32	OXY	EXO	329
984A-G05X1A-32-27	OXY	EXO	329
984A-G05X1A-47	OXY	EXO	329
984A-G05X1A-47-27	OXY	EXO	329
984B-G05X1A-02	OXY	EXO	329
984B-G05X1A-02-27	OXY	EXO	329
984B-G05X1A-32	OXY	EXO	329
984B-G05X1A-32-27	OXY	EXO	329
984B-G05X1A-47	OXY	EXO	329
984B-G05X1A-47-27	OXY	EXO	329
984C-G05X1A-02	OXY	EXO	329
984C-G05X1A-02-27	OXY	EXO	329
984C-G05X1A-32	OXY	EXO	329
984C-G05X1A-32-27	OXY	EXO	329
984C-G05X1A-47	OXY	EXO	329
984C-G05X1A-47-27	OXY	EXO	329
984D-G05X1A-02	OXY	EXO	329
984D-G05X1A-02-27	OXY	EXO	329
984D-G05X1A-32	OXY	EXO	329
984D-G05X1A-32-27	OXY	EXO	329
984D-G05X1A-47	OXY	EXO	329
984D-G05X1A-47-27	OXY	EXO	329
984E-G05X1A-02	OXY	EXO	329
984E-G05X1A-02-27	OXY	EXO	329
984E-G05X1A-32	OXY	EXO	329
984E-G05X1A-32-27	OXY	EXO	329
984E-G05X1A-47	OXY	EXO	329
984E-G05X1A-47-27	OXY	EXO	329
984F-G05X1A-02	OXY	EXO	276
984F-G05X1A-02-27	OXY	EXO	276
984F-G05X1A-32	OXY	EXO	276
984F-G05X1A-32-27	OXY	EXO	276
984F-G05X1A-47	OXY	EXO	276
984F-G05X1A-47-27	OXY	EXO	276
984H-G05X1A-02-27	OXY	EXO	330
984I-G05X1A-02-27	OXY	EXO	330

REF.	FAM.	BRAND	PAG.
984J-G05X1A-02-27	OXY	EXO	330
984K-G05X1A-02-27	OXY	EXO	327
984L-G05X1A-02-27	OXY	EXO	327
985A-G05X1A-02-R1	THAIS	EXO	347
985B-G05X1A-02-R1	THAIS	EXO	347
985C-G05X1A-02-R1	THAIS	EXO	347
985D-G05X1A-02-R1	THAIS	EXO	347
985E-G05X1A-02-R1	THAIS	EXO	347
985F-G05X1A-02-R1	THAIS	EXO	347
986A-G05X1A-35-CA	CLASSICAL	EXO	278
986A-G05X1A-47-CB	CLASSICAL	EXO	278
986B-G05X1A-35-CA	CLASSICAL	EXO	392
986B-G05X1A-47-CB	CLASSICAL	EXO	392
986C-G05X1A-35-CA	CLASSICAL	EXO	393
986C-G05X1A-47-CB	CLASSICAL	EXO	393
987A-L0109B-01	COOPER	EXO	307
987A-L0109B-02	COOPER	EXO	307
987A-L0109B-46	COOPER	EXO	307
987A-L0109B-BR	COOPER	EXO	307
988A-L0109B-01	CIRCULAR	EXO	305
988A-L0109B-02	CIRCULAR	EXO	305
988B-L0113B-01	CIRCULAR	EXO	305
988B-L0113B-02	CIRCULAR	EXO	305
988C-L0128B-01	CIRCULAR	EXO	305
988C-L0128B-02	CIRCULAR	EXO	305
988D-L0140B-01	CIRCULAR	EXO	305
988D-L0140B-02	CIRCULAR	EXO	305
990A-G04X1A-01	MANTIS	EXO	414
991A-G21X1A-01	TEAR	EXO	290
991A-G21X1A-02	TEAR	EXO	290
992A-G04X1A-01	TAICHI	EXO	410
992A-G04X1A-02	TAICHI	EXO	410
992B-G04X1A-01	TAICHI	EXO	411
992B-G04X1A-02	TAICHI	EXO	411
995A-H20X1A-04	LUA	DOPO	554
996A-L3106B-04	TERRA	DOPO	522
996A-L3106C-04	TERRA	DOPO	522
996A-L3306B-04	TERRA	DOPO	522
997A-L3825B20-01	AMY	INDELUZ	251
997A-L3825B20-02	AMY	INDELUZ	251
997A-L3825B30-01	AMY	INDELUZ	251
997A-L3825B30-02	AMY	INDELUZ	251
997A-L3825B60-01	AMY	INDELUZ	251
997A-L3825B60-02	AMY	INDELUZ	251
997A-L3925B20-01	AMY	INDELUZ	251
997A-L3925B20-02	AMY	INDELUZ	251
997A-L3925B30-01	AMY	INDELUZ	251
997A-L3925B30-02	AMY	INDELUZ	251
997A-L3925B60-01	AMY	INDELUZ	251
997A-L3925B60-02	AMY	INDELUZ	251
997A-L4025B20-01	AMY	INDELUZ	251
997A-L4025B20-02	AMY	INDELUZ	251
997A-L4025B30-01	AMY	INDELUZ	251
997A-L4025B30-02	AMY	INDELUZ	251
997A-L4025B60-01	AMY	INDELUZ	251
997A-L4025B60-02	AMY	INDELUZ	251
998A-L3106E-02	GIBSON	CRISTHER	721
998A-L3306E-02	GIBSON	CRISTHER	721
998B-L310E-02	GIBSON	CRISTHER	721
998B-L3310E-02	GIBSON	CRISTHER	721
998C-L3106E-02	GIBSON	CRISTHER	721
998C-L3306E-02	GIBSON	CRISTHER	721

REF.	FAM.	BRAND	PAG.	REF.	FAM.	BRAND	PAG.
998D-L3110E-02	GIBSON	CRISTHER	721	1002A-	TURT	INDELUZ	141
998D-L3310E-02	GIBSON	CRISTHER	721	1003A-	ARROW	INDELUZ	143
999A-L0125A-04	FENDER	CRISTHER	761	1003B-	ARROW	INDELUZ	143
999A-L0150A-04	FENDER	CRISTHER	761	1004A-	SCOP	INDELUZ	51
999A-L0225A-04	FENDER	CRISTHER	761	1004B-	SCOP	INDELUZ	51
999A-L0250A-04	FENDER	CRISTHER	761	1005A-	QUO	INDELUZ	53
999B-L0125A-04	FENDER	CRISTHER	761	1005B-	QUO	INDELUZ	55
999B-L0150A-04	FENDER	CRISTHER	761	1005C-	QUO	INDELUZ	57
999B-L0225A-04	FENDER	CRISTHER	761	1006A-	VIP1	INDELUZ	61
999B-L0250A-04	FENDER	CRISTHER	761	1007A-	VIP2	INDELUZ	65
1000A-L3009B10-01	DISC	CRISTHER	717	1007B-	VIP2	INDELUZ	67
1000A-L3009B10-04	DISC	CRISTHER	717	1008A-	VIP3	INDELUZ	71
1000A-L3009B30-01	DISC	CRISTHER	717	1008B-	VIP3	INDELUZ	73
1000A-L3009B30-04	DISC	CRISTHER	717	1009A-	VIP1 T	INDELUZ	63
1000A-L3009B50-01	DISC	CRISTHER	717	1010A-	VIP2 T	INDELUZ	69
1000A-L3009B50-04	DISC	CRISTHER	717	1011A-	VIP3 T	INDELUZ	75
1000A-L3013B10-01	DISC	CRISTHER	717	1012A-G21X1A-02-51	BRANCH	EXO	416
1000A-L3013B10-04	DISC	CRISTHER	717	1013A-L3826B-01	FISH	EXO	319
1000A-L3013B30-01	DISC	CRISTHER	717	1013A-L3826B-02	FISH	EXO	319
1000A-L3013B30-04	DISC	CRISTHER	717	1013A-L3826B-50	FISH	EXO	319
1000A-L3013B50-01	DISC	CRISTHER	717	1013A-L4026B-01	FISH	EXO	319
1000A-L3013B50-04	DISC	CRISTHER	717	1013A-L4026B-02	FISH	EXO	319
1000A-L3109B10-01	DISC	CRISTHER	717	1013A-L4026B-50	FISH	EXO	319
1000A-L3109B10-04	DISC	CRISTHER	717	1013B-L3826A-01	FISH	EXO	317
1000A-L3109B30-01	DISC	CRISTHER	717	1013B-L3826A-02	FISH	EXO	317
1000A-L3109B30-04	DISC	CRISTHER	717	1013B-L3826A-50	FISH	EXO	317
1000A-L3109B50-01	DISC	CRISTHER	717	1013B-L4026A-01	FISH	EXO	317
1000A-L3109B50-04	DISC	CRISTHER	717	1013B-L4026A-02	FISH	EXO	317
1000A-L3113B10-01	DISC	CRISTHER	717	1013B-L4026A-50	FISH	EXO	317
1000A-L3113B10-04	DISC	CRISTHER	717	1014A-G05X1A-02	AKIRO	EXO	343
1000A-L3113B30-01	DISC	CRISTHER	717	1014A-G05X1A-02-SC	AKIRO	EXO	343
1000A-L3113B30-04	DISC	CRISTHER	717	1014B-G05X1A-02	AKIRO	EXO	343
1000A-L3113B50-01	DISC	CRISTHER	717	1014B-G05X1A-02-SC	AKIRO	EXO	343
1000A-L3113B50-04	DISC	CRISTHER	717	1014C-L3109B-02	AKIRO	EXO	387
1000A-L3309B10-01	DISC	CRISTHER	717	1014C-L3109B-02-SC	AKIRO	EXO	387
1000A-L3309B10-04	DISC	CRISTHER	717	1014D-L3114B-02	AKIRO	EXO	387
1000A-L3309B30-01	DISC	CRISTHER	717	1014D-L3114B-02-SC	AKIRO	EXO	387
1000A-L3309B30-04	DISC	CRISTHER	717	1015A-G05X1A-01	LUG	DOPO	451
1000A-L3309B50-01	DISC	CRISTHER	717	1015A-G05X1A-04	LUG	DOPO	451
1000A-L3309B50-04	DISC	CRISTHER	717	1015B-G05X1A-01	LUG	DOPO	539
1000A-L3313B10-01	DISC	CRISTHER	717	1015B-G05X1A-04	LUG	DOPO	539
1000A-L3313B10-04	DISC	CRISTHER	717	1015C-G05X1A-01	LUG	DOPO	539
1000A-L3313B30-01	DISC	CRISTHER	717	1015C-G05X1A-04	LUG	DOPO	539
1000A-L3313B30-04	DISC	CRISTHER	717	1016A-G05X1A-04	AVON	DOPO	454
1000A-L3313B50-01	DISC	CRISTHER	717	1016B-G05X1A-04	AVON	DOPO	544
1000A-L3313B50-04	DISC	CRISTHER	717	1017A-G05X1A-01-D1	NEMO	EXO	281
1001A-L3140A90-04	VENT	CRISTHER	759	1017A-G05X1A-01-D2	NEMO	EXO	281
1001A-L3140A9D-04	VENT	CRISTHER	759	1017A-G05X1A-01-D3	NEMO	EXO	281
1001A-L3175A90-04	VENT	CRISTHER	759	1017A-G05X1A-02-D4	NEMO	EXO	281
1001A-L3175A9D-04	VENT	CRISTHER	759	1017B-G05X1A-01-D1	NEMO	EXO	388
1001A-L3340A90-04	VENT	CRISTHER	759	1017B-G05X1A-01-D2	NEMO	EXO	388
1001A-L3340A9D-04	VENT	CRISTHER	759	1017B-G05X1A-01-D3	NEMO	EXO	388
1001A-L3375A90-04	VENT	CRISTHER	759	1017B-G05X1A-02-D4	NEMO	EXO	388
1001A-L3375A9D-04	VENT	CRISTHER	759	1017C-G05X1A-01-D1	NEMO	EXO	389
1001B-L3140A90-04	VENT	CRISTHER	759	1017C-G05X1A-01-D2	NEMO	EXO	389
1001B-L3140A9D-04	VENT	CRISTHER	759	1017C-G05X1A-01-D3	NEMO	EXO	389
1001B-L3175A90-04	VENT	CRISTHER	759	1017C-G05X1A-02-D4	NEMO	EXO	389
1001B-L3175A9D-04	VENT	CRISTHER	759	1017D-G05X1A-01-D1	NEMO	EXO	388
1001B-L3340A90-04	VENT	CRISTHER	759	1017D-G05X1A-01-D2	NEMO	EXO	388
1001B-L3340A9D-04	VENT	CRISTHER	759	1017D-G05X1A-01-D3	NEMO	EXO	388
1001B-L3375A90-04	VENT	CRISTHER	759	1017D-G05X1A-02-D4	NEMO	EXO	388
1001B-L3375A9D-04	VENT	CRISTHER	759	1018A-L3109AA0-04	TURRET	CRISTHER	741



REFERENCE INDEX PVP

REF.	FAM.	BRAND	PAG.
1018A-L3309AA0-04	TURRET	CRISTHER	741
1018B-L3112AA0-04	TURRET	CRISTHER	741
1018B-L3312AA0-04	TURRET	CRISTHER	741
1021A-G21X1A-01	TEN	INDELUZ	249
1021A-G21X1A-02	TEN	INDELUZ	249
1021B-G21X1A-01	TEN	INDELUZ	249
1021B-G21X1A-02	TEN	INDELUZ	249
1023A-L3107B10-30	MALVA	CRISTHER	684
1023A-L3107B20-30	MALVA	CRISTHER	684
1023A-L3107B50-30	MALVA	CRISTHER	684
1023A-L3307B10-30	MALVA	CRISTHER	684
1023A-L3307B20-30	MALVA	CRISTHER	684
1023A-L3307B50-30	MALVA	CRISTHER	684
1023B-L3116B10-30	MALVA	CRISTHER	685
1023B-L3116B1D-30	MALVA	CRISTHER	685
1023B-L3116B30-30	MALVA	CRISTHER	685
1023B-L3116B3D-30	MALVA	CRISTHER	685
1023B-L3116B40-30	MALVA	CRISTHER	685
1023B-L3116B4D-30	MALVA	CRISTHER	685
1023B-L3316B10-30	MALVA	CRISTHER	685
1023B-L3316B1D-30	MALVA	CRISTHER	685
1023B-L3316B30-30	MALVA	CRISTHER	685
1023B-L3316B3D-30	MALVA	CRISTHER	685
1023B-L3316B40-30	MALVA	CRISTHER	685
1023B-L3316B4D-30	MALVA	CRISTHER	685
1023C-L3116B30-30	MALVA	CRISTHER	685
1023C-L3116B3D-30	MALVA	CRISTHER	685
1023C-L3316B30-30	MALVA	CRISTHER	685
1023C-L3316B3D-30	MALVA	CRISTHER	685
1023D-L3125B10-30	MALVA	CRISTHER	686
1023D-L3125B1D-30	MALVA	CRISTHER	686
1023D-L3125B30-30	MALVA	CRISTHER	686
1023D-L3125B3D-30	MALVA	CRISTHER	686
1023D-L3125B40-30	MALVA	CRISTHER	686
1023D-L3125B4D-30	MALVA	CRISTHER	686
1023D-L3325B10-30	MALVA	CRISTHER	686
1023D-L3325B1D-30	MALVA	CRISTHER	686
1023D-L3325B30-30	MALVA	CRISTHER	686
1023D-L3325B3D-30	MALVA	CRISTHER	686
1023D-L3325B40-30	MALVA	CRISTHER	686
1023D-L3325B4D-30	MALVA	CRISTHER	686
1023E-L3125B30-30	MALVA	CRISTHER	686
1023E-L3125B3D-30	MALVA	CRISTHER	686
1023E-L3325B30-30	MALVA	CRISTHER	686
1023E-L3325B3D-30	MALVA	CRISTHER	686
1023F-L1412F1X-30	MALVA RGB	CRISTHER	687
1023F-L1412F3X-30	MALVA RGB	CRISTHER	687
1023F-L1412F6X-30	MALVA RGB	CRISTHER	687
1024A-L3112BX0-04	LANCE	CRISTHER	723
1024A-L3118BX0-04	LANCE	CRISTHER	723
1024A-L3312BX0-04	LANCE	CRISTHER	723
1024A-L3318BX0-04	LANCE	CRISTHER	723
1024B-L3112BX0-04	LANCE	CRISTHER	645
1024B-L3112BXD-04	LANCE	CRISTHER	645
1024B-L3312BX0-04	LANCE	CRISTHER	645
1024B-L3312BXD-04	LANCE	CRISTHER	645
1024C-L3115BX0-04	LANCE	CRISTHER	699
1024C-L3315BX0-04	LANCE	CRISTHER	699
1025A-L3118F40-03	RIGA	DOPO	529
1025A-L3118FK0-03	RIGA	DOPO	529
1025A-L3318F40-03	RIGA	DOPO	529
1025A-L3318FK0-03	RIGA	DOPO	529

REF.	FAM.	BRAND	PAG.
1025B-L3136F40-03	RIGA	DOPO	529
1025B-L3136FK0-03	RIGA	DOPO	529
1025B-L3336F40-03	RIGA	DOPO	529
1025B-L3336FK0-03	RIGA	DOPO	529
1025C-L1418F4X-03	RIGA	DOPO	531
1025C-L1418FKX-03	RIGA	DOPO	531
1025D-L1436F4X-03	RIGA	DOPO	531
1025D-L1436FKX-03	RIGA	DOPO	531
1027A-L3107BX0-04	SIMIL	DOPO	450
1027B-L3107B30-04	SIMIL	DOPO	538
1028A-L38RCB-02-05	KRISTA	EXO	324
1028B-L38RCB-02-05	KRISTA	EXO	324
1028C-L38RCB-02-05	KRISTA	EXO	324
1028D-L38RCB-02-06	KRISTA	EXO	323
1028E-L38RCB-02-06	KRISTA	EXO	323
1028F-L38RCB-02-06	KRISTA	EXO	323
1028G-L38RCB-02-05	KRISTA	EXO	271
1028G-L38RCB-02-06	KRISTA	EXO	271
1028H-L38RCB-02-FG	KRISTA	EXO	325
1028I-L38RCB-02-FG	KRISTA	EXO	325
1028J-L38RCB-02-FG	KRISTA	EXO	325
1028K-L38RCB-02-05	KRISTA	EXO	381
1028K-L38RCB-02-06	KRISTA	EXO	381
1028K-L38RCB-02-FG	KRISTA	EXO	381
1029A-G05X1A-02-M1	NATURAL	EXO	345
1029A-G05X1A-02-M2	NATURAL	EXO	345
1029B-G05X1A-02-M1	NATURAL	EXO	345
1029B-G05X1A-02-M2	NATURAL	EXO	345
1029C-G05X1A-02-M1	NATURAL	EXO	345
1029C-G05X1A-02-M2	NATURAL	EXO	345
1029D-G05X1A-02-M1	NATURAL	EXO	345
1029D-G05X1A-02-M2	NATURAL	EXO	345
1029E-G05X1A-02-M1	NATURAL	EXO	345
1029E-G05X1A-02-M2	NATURAL	EXO	345
1029F-G05X1A-02-M1	NATURAL	EXO	345
1029F-G05X1A-02-M2	NATURAL	EXO	345
1030A-G05X1A-01-RA	MOLN	EXO	351
1030B-G05X1A-01-RA	MOLN	EXO	351
1031A-L3106B-01	SERENE	EXO	296
1031A-L3106B-02	SERENE	EXO	296
1031B-L3106B-01	SERENE	EXO	296
1031B-L3106B-02	SERENE	EXO	296
1031C-L3106B-01	SERENE	EXO	297
1031C-L3106B-02	SERENE	EXO	297
1032A-L3807V20-01	CRETE1	INDELUZ	158
1032A-L3807V20-02	CRETE1	INDELUZ	158
1032A-L3807V2D-01	CRETE1	INDELUZ	158
1032A-L3807V2D-02	CRETE1	INDELUZ	158
1032A-L3807V30-01	CRETE1	INDELUZ	158
1032A-L3807V30-02	CRETE1	INDELUZ	158
1032A-L3807V3D-01	CRETE1	INDELUZ	158
1032A-L3807V3D-02	CRETE1	INDELUZ	158
1032A-L3907V20-01	CRETE1	INDELUZ	158
1032A-L3907V20-02	CRETE1	INDELUZ	158
1032A-L3907V2D-01	CRETE1	INDELUZ	158
1032A-L3907V2D-02	CRETE1	INDELUZ	158
1032A-L3907V30-01	CRETE1	INDELUZ	158
1032A-L3907V30-02	CRETE1	INDELUZ	158
1032A-L3907V3D-01	CRETE1	INDELUZ	158
1032A-L3907V3D-02	CRETE1	INDELUZ	158
1032B-L3811V10-01	CRETE1	INDELUZ	159



REF.	FAM.	BRAND	PAG.	REF.	FAM.	BRAND	PAG.
1032B-L3811V10-02	CRETE1	INDELUZ	159	1036D-L4109B3C-01	KRAO	INDELUZ	215
1032B-L3811VID-01	CRETE1	INDELUZ	159	1036E-L4108BAZ-01	KRAO	INDELUZ	215
1032B-L3811VID-02	CRETE1	INDELUZ	159	1037A-G05X1A-02-M1	VIETNAM	EXO	349
1032B-L3811V20-01	CRETE1	INDELUZ	159	1037A-G05X1A-02-M2	VIETNAM	EXO	349
1032B-L3811V20-02	CRETE1	INDELUZ	159	1037B-G05X1A-02-M1	VIETNAM	EXO	349
1032B-L3811V2D-01	CRETE1	INDELUZ	159	1037B-G05X1A-02-M2	VIETNAM	EXO	349
1032B-L3811V2D-02	CRETE1	INDELUZ	159	1037C-G05X1A-02-M1	VIETNAM	EXO	349
1032B-L3811V30-01	CRETE1	INDELUZ	159	1037C-G05X1A-02-M2	VIETNAM	EXO	349
1032B-L3811V30-02	CRETE1	INDELUZ	159	1038A-L3808V10-01	CRETE2	INDELUZ	162
1032B-L3811V3D-01	CRETE1	INDELUZ	159	1038A-L3808V10-02	CRETE2	INDELUZ	162
1032B-L3811V3D-02	CRETE1	INDELUZ	159	1038A-L3808VID-01	CRETE2	INDELUZ	162
1032B-L3911V10-01	CRETE1	INDELUZ	159	1038A-L3808VID-02	CRETE2	INDELUZ	162
1032B-L3911V10-02	CRETE1	INDELUZ	159	1038A-L3808V30-01	CRETE2	INDELUZ	162
1032B-L3911VID-01	CRETE1	INDELUZ	159	1038A-L3808V30-02	CRETE2	INDELUZ	162
1032B-L3911VID-02	CRETE1	INDELUZ	159	1038A-L3808V3D-01	CRETE2	INDELUZ	162
1032B-L3911V20-01	CRETE1	INDELUZ	159	1038A-L3808V3D-02	CRETE2	INDELUZ	162
1032B-L3911V20-02	CRETE1	INDELUZ	159	1038A-L3808V50-01	CRETE2	INDELUZ	162
1032B-L3911V2D-01	CRETE1	INDELUZ	159	1038A-L3808V50-02	CRETE2	INDELUZ	162
1032B-L3911V2D-02	CRETE1	INDELUZ	159	1038A-L3808V5D-01	CRETE2	INDELUZ	162
1032B-L3911V30-01	CRETE1	INDELUZ	159	1038A-L3808V5D-02	CRETE2	INDELUZ	162
1032B-L3911V30-02	CRETE1	INDELUZ	159	1038A-L3908V10-01	CRETE2	INDELUZ	162
1032B-L3911V3D-01	CRETE1	INDELUZ	159	1038A-L3908V10-02	CRETE2	INDELUZ	162
1032B-L3911V3D-02	CRETE1	INDELUZ	159	1038A-L3908VID-01	CRETE2	INDELUZ	162
1032C-L3818V20-01	CRETE1	INDELUZ	160	1038A-L3908VID-02	CRETE2	INDELUZ	162
1032C-L3818V20-02	CRETE1	INDELUZ	160	1038A-L3908V30-01	CRETE2	INDELUZ	162
1032C-L3818V2D-01	CRETE1	INDELUZ	160	1038A-L3908V30-02	CRETE2	INDELUZ	162
1032C-L3818V2D-02	CRETE1	INDELUZ	160	1038A-L3908V3D-01	CRETE2	INDELUZ	162
1032C-L3818V30-01	CRETE1	INDELUZ	160	1038A-L3908V3D-02	CRETE2	INDELUZ	162
1032C-L3818V30-02	CRETE1	INDELUZ	160	1038A-L3908V50-01	CRETE2	INDELUZ	162
1032C-L3818V3D-01	CRETE1	INDELUZ	160	1038A-L3908V50-02	CRETE2	INDELUZ	162
1032C-L3818V3D-02	CRETE1	INDELUZ	160	1038A-L3908V5D-01	CRETE2	INDELUZ	162
1032C-L3918V20-01	CRETE1	INDELUZ	160	1038A-L3908V5D-02	CRETE2	INDELUZ	162
1032C-L3918V20-02	CRETE1	INDELUZ	160	1038B-L3815V10-01	CRETE2	INDELUZ	163
1032C-L3918V2D-01	CRETE1	INDELUZ	160	1038B-L3815V10-02	CRETE2	INDELUZ	163
1032C-L3918V2D-02	CRETE1	INDELUZ	160	1038B-L3815VID-01	CRETE2	INDELUZ	163
1032C-L3918V30-01	CRETE1	INDELUZ	160	1038B-L3815VID-02	CRETE2	INDELUZ	163
1032C-L3918V30-02	CRETE1	INDELUZ	160	1038B-L3815V30-01	CRETE2	INDELUZ	163
1032C-L3918V3D-01	CRETE1	INDELUZ	160	1038B-L3815V30-02	CRETE2	INDELUZ	163
1032C-L3918V3D-02	CRETE1	INDELUZ	160	1038B-L3815V3D-01	CRETE2	INDELUZ	163
1032D-L3813VVO-01	CRETE1	INDELUZ	161	1038B-L3815V3D-02	CRETE2	INDELUZ	163
1032D-L3813VVO-02	CRETE1	INDELUZ	161	1038B-L3815V50-01	CRETE2	INDELUZ	163
1032D-L3813VVD-01	CRETE1	INDELUZ	161	1038B-L3815V50-02	CRETE2	INDELUZ	163
1032D-L3813VVD-02	CRETE1	INDELUZ	161	1038B-L3815V5D-01	CRETE2	INDELUZ	163
1032D-L3913VVO-01	CRETE1	INDELUZ	161	1038B-L3815V5D-02	CRETE2	INDELUZ	163
1032D-L3913VVO-02	CRETE1	INDELUZ	161	1038B-L3915V10-01	CRETE2	INDELUZ	163
1032D-L3913VVD-01	CRETE1	INDELUZ	161	1038B-L3915V10-02	CRETE2	INDELUZ	163
1032D-L3913VVD-02	CRETE1	INDELUZ	161	1038B-L3915VID-01	CRETE2	INDELUZ	163
1033B-G05X1A-01-CA	CERAMIC	EXO	383	1038B-L3915VID-02	CRETE2	INDELUZ	163
1033B-G05X1A-02-CK	CERAMIC	EXO	383	1038B-L3915V30-01	CRETE2	INDELUZ	163
1033B-G05X1A-47-SG	CERAMIC	EXO	383	1038B-L3915V30-02	CRETE2	INDELUZ	163
1033C-G05X1A-01-CA	CERAMIC	EXO	383	1038B-L3915V3D-01	CRETE2	INDELUZ	163
1033C-G05X1A-02-CK	CERAMIC	EXO	383	1038B-L3915V3D-02	CRETE2	INDELUZ	163
1033C-G05X1A-47-SG	CERAMIC	EXO	383	1038B-L3915V50-01	CRETE2	INDELUZ	163
1034A-L4106B-01	MURA	DOPO	445	1038B-L3915V50-02	CRETE2	INDELUZ	163
1034A-L4106B-02	MURA	DOPO	445	1038B-L3915V5D-01	CRETE2	INDELUZ	163
1034B-L4110B-01	MURA	DOPO	445	1038B-L3915V5D-02	CRETE2	INDELUZ	163
1034B-L4110B-02	MURA	DOPO	445	1038C-L3806VBO-01	CRETE2	INDELUZ	164
1035A-L3150AAO-02	FANAL	CRISTHER	757	1038C-L3806VBO-02	CRETE2	INDELUZ	164
1035A-L3350AAO-02	FANAL	CRISTHER	757	1038C-L3806VBD-01	CRETE2	INDELUZ	164
1036A-L4107BAO-01	KRAO	INDELUZ	214	1038C-L3806VBD-02	CRETE2	INDELUZ	164
1036B-L4105B30-01	KRAO	INDELUZ	214	1038C-L3906VBO-01	CRETE2	INDELUZ	164
1036C-L4109BAC-01	KRAO	INDELUZ	215	1038C-L3906VBO-02	CRETE2	INDELUZ	164

REF.	FAM.	BRAND	PAG.
1038C-L3906VBD-01	CRETE2	INDELUZ	164
1038C-L3906VBD-02	CRETE2	INDELUZ	164
1038D-L3813VBO-01	CRETE2	INDELUZ	164
1038D-L3813VBO-02	CRETE2	INDELUZ	164
1038D-L3813VBD-01	CRETE2	INDELUZ	164
1038D-L3813VBD-02	CRETE2	INDELUZ	164
1038D-L3913VBO-01	CRETE2	INDELUZ	164
1038D-L3913VBO-02	CRETE2	INDELUZ	164
1038D-L3913VBD-01	CRETE2	INDELUZ	164
1038D-L3913VBD-02	CRETE2	INDELUZ	164
1038E-L3825VBO-01	CRETE2	INDELUZ	165
1038E-L3825VBO-02	CRETE2	INDELUZ	165
1038E-L3825VBD-01	CRETE2	INDELUZ	165
1038E-L3825VBD-02	CRETE2	INDELUZ	165
1038E-L3925VBO-01	CRETE2	INDELUZ	165
1038E-L3925VBO-02	CRETE2	INDELUZ	165
1038E-L3925VBD-01	CRETE2	INDELUZ	165
1038E-L3925VBD-02	CRETE2	INDELUZ	165
1039A-L3120B-01	PETAL	EXO	304
1039A-L3120B-02	PETAL	EXO	304
1039A-L3120B-46	PETAL	EXO	304
1040A-L3109H30-01	ATIC	CRISTHER	674
1040A-L3309H30-01	ATIC	CRISTHER	674
1040B-L3118I50-01	ATIC	CRISTHER	674
1040B-L3318I50-01	ATIC	CRISTHER	674
1040C-L3124J70-01	ATIC	CRISTHER	675
1040C-L3324J70-01	ATIC	CRISTHER	675
1040D-L3137M90-01	ATIC	CRISTHER	675
1040D-L3337M90-01	ATIC	CRISTHER	675
1041A-L4103K-02	VERSA	DOPO	564
1042A-L4106K-02	TONA	DOPO	567
1042B-L4106K-02	TONA	DOPO	567
1043A-L4103K-02	LUMBER	DOPO	565
1044A-L4105K-02	ERGO	DOPO	563
1044B-L4105K-02	ERGO	DOPO	563
1044C-L4105K-02	ERGO	DOPO	563
1045A-G05X1A-02	FLAKE	EXO	331
1046A-L3336B-02	OFFICE	INDELUZ	247
1046B-L3336B-02	OFFICE	INDELUZ	247
1047A-L3130B-02	KERO	DOPO	517
1047A-L3330B-02	KERO	DOPO	517
1047A-L3730B-02	KERO	DOPO	517
1047B-L3150B-02	KERO	DOPO	517
1047B-L3350B-02	KERO	DOPO	517
1047B-L3750B-02	KERO	DOPO	517
1047C-L31A1B-02	KERO	DOPO	517
1047C-L33A1B-02	KERO	DOPO	517
1047C-L37A1B-02	KERO	DOPO	517
1047D-L31A4B-02	KERO	DOPO	517
1047D-L33A4B-02	KERO	DOPO	517
1047D-L37A4B-02	KERO	DOPO	517
1047E-L31A5B-02	KERO	DOPO	517
1047E-L33A5B-02	KERO	DOPO	517
1047E-L37A5B-02	KERO	DOPO	517
1048A-L33RAB-04	LAUTAN	INDELUZ	239
1048A-L37RAB-04	LAUTAN	INDELUZ	239
1048B-L33RAB-04	LAUTAN	INDELUZ	239
1048B-L37RAB-04	LAUTAN	INDELUZ	239
1048C-L33RAB-04	LAUTAN	INDELUZ	239
1048C-L37RAB-04	LAUTAN	INDELUZ	239
1049A-L3120B-01	FLOC	DOPO	475
1049A-L3120B-02	FLOC	DOPO	475

REF.	FAM.	BRAND	PAG.
1049B-L3130B-01	FLOC	DOPO	475
1049B-L3130B-02	FLOC	DOPO	475
1050A-L3113B-04	EVEN	DOPO	447
1051A-L2925ABO-02	PALAU	CRISTHER	730
1051A-L2925ABD-02	PALAU	CRISTHER	730
1051A-L2925ABG-02	PALAU	CRISTHER	730
1051A-L3025ABO-02	PALAU	CRISTHER	730
1051A-L3025ABD-02	PALAU	CRISTHER	730
1051A-L3025ABG-02	PALAU	CRISTHER	730
1051A-L3125ABO-02	PALAU	CRISTHER	730
1051A-L3125ABD-02	PALAU	CRISTHER	730
1051A-L3125ABG-02	PALAU	CRISTHER	730
1051A-L325ABG-02	PALAU	CRISTHER	730
1051A-L3325ABO-02	PALAU	CRISTHER	730
1051A-L3325ABD-02	PALAU	CRISTHER	730
1051A-L3325ABG-02	PALAU	CRISTHER	730
1051B-L2925ABO-02	PALAU	CRISTHER	731
1051B-L2925ABD-02	PALAU	CRISTHER	731
1051B-L2925ABG-02	PALAU	CRISTHER	731
1051B-L3025ABO-02	PALAU	CRISTHER	731
1051B-L3025ABD-02	PALAU	CRISTHER	731
1051B-L3025ABG-02	PALAU	CRISTHER	731
1051B-L3125ABO-02	PALAU	CRISTHER	731
1051B-L3125ABD-02	PALAU	CRISTHER	731
1051B-L3125ABG-02	PALAU	CRISTHER	731
1051B-L325ABO-02	PALAU	CRISTHER	731
1051B-L325ABD-02	PALAU	CRISTHER	731
1051B-L325ABG-02	PALAU	CRISTHER	731
1052A-L3806BVO-04	KALOS	CRISTHER	711
1052A-L3906BVO-04	KALOS	CRISTHER	711
1052A-L4006BVO-04	KALOS	CRISTHER	711
1052B-L3812BVO-04	KALOS	CRISTHER	711
1052B-L3912BVO-04	KALOS	CRISTHER	711
1052B-L4012BVO-04	KALOS	CRISTHER	711
1052C-L3828BVO-04	KALOS	CRISTHER	711
1052C-L3928BVO-04	KALOS	CRISTHER	711
1052C-L4028BVO-04	KALOS	CRISTHER	711
1053A-L4102B90-01	COVER	INDELUZ	243
1054A-L3110B-04	ORBITA	DOPO	444
1054B-L3110B-04	ORBITA	DOPO	535
1055x-	UKU	INDELUZ	129
1056x-	UKU	INDELUZ	131
1057x-	UKU	INDELUZ	133
1058x-	UKU	INDELUZ	135
1059x-	UKU	INDELUZ	137
1060x-	UKU	INDELUZ	139
1061x-	FENIX	INDELUZ	115
1062x-	FENIX	INDELUZ	109
1063x-	FENIX	INDELUZ	113
1064x-	FENIX	INDELUZ	117
1065x-	FENIX	INDELUZ	111
1066x-	FENIX	INDELUZ	107
1069A-L3011FCO-04	DUOMO	CRISTHER	640
1069A-L3111FCO-04	DUOMO	CRISTHER	640
1069A-L3311FCO-04	DUOMO	CRISTHER	640
1069B-L3011FCO-04	DUOMO	CRISTHER	733
1069B-L3111FCO-04	DUOMO	CRISTHER	733
1069B-L3311FCO-04	DUOMO	CRISTHER	733
1069C-L3011FCO-04	DUOMO	CRISTHER	733
1069C-L3111FCO-04	DUOMO	CRISTHER	733
1069C-L3311FCO-04	DUOMO	CRISTHER	733
1069D-L3011FCO-04	DUOMO	CRISTHER	733
1069D-L3111FCO-04	DUOMO	CRISTHER	733
1069D-L3311FCO-04	DUOMO	CRISTHER	733

REF.	FAM.	BRAND	PAG.	REF.	FAM.	BRAND	PAG.
1069D-L3311FCO-04	DUOMO	CRISTHER	733	A02F-004-00	POSTES	DOPO	603
1070A-L3002FXO-30	GARDA	CRISTHER	693	A02G-004-00	POSTES	DOPO	603
1070A-L3102FXO-30	GARDA	CRISTHER	693	A04M-796-02	DUBE	INDELUZ	144
1070A-L3302FXO-30	GARDA	CRISTHER	693	A04P-1002-02	ACCESORIOS	INDELUZ	50, 140
1070B-L3002FXO-30	GARDA	CRISTHER	693	A04P-1003-02	ACCESORIOS	INDELUZ	142
1070B-L3102FXO-30	GARDA	CRISTHER	693	A04P-1004-02	ACCESORIOS	INDELUZ	50
1070B-L3302FXO-30	GARDA	CRISTHER	693	A04Q-1006-02	VIP	INDELUZ	59
1070C-L3002FXO-30	GARDA	CRISTHER	693	A05A-1000A-02	DISC	CRISTHER	711, 717
1070C-L3102FXO-30	GARDA	CRISTHER	693	A05A-1052A-02	KALOS	CRISTHER	711
1070C-L3302FXO-30	GARDA	CRISTHER	693	A05A-1069-02	DUOMO	CRISTHER	733
1070D-L3006FXO-30	GARDA	CRISTHER	693	A05A-409-02	NAPOLÉS/LULU	DOPO	523
1070D-L3106FXO-30	GARDA	CRISTHER	693	A05A-922A-02	DADO	CRISTHER	718
1070D-L3306FXO-30	GARDA	CRISTHER	693	A05A-922C-02	DADO	CRISTHER	719
1070E-L3006FXO-30	GARDA	CRISTHER	693	A06A-004-01	ELITE 6	DOPO	608
1070E-L3106FXO-30	GARDA	CRISTHER	693	A06A-004-02	ELITE 6	DOPO	608
1070E-L3306FXO-30	GARDA	CRISTHER	693	A07A-128-00	GLOBOS	DOPO	601
1070F-L3006FXO-30	GARDA	CRISTHER	693	A07A-406-39	ROUND	DOPO	605,606
1070F-L3106FXO-30	GARDA	CRISTHER	693	A08A-C07-01	POSTES	DOPO	591
1070F-L3306FXO-30	GARDA	CRISTHER	693	A08A-C07-02	POSTES	DOPO	591
1071A-L4110BBF-02	CROMA	DOPO	449	A11A-233-00	PAR 56 LED	CRISTHER	774
1071B-L4115BBF-02	CROMA	DOPO	449	A12A-077-01	CUP	CRISTHER	780
1072A-L4108BBF-02	IKONA	DOPO	448	A13A-	INEL	INDELUZ	85
1072B-L4108BBF-02	IKONA	DOPO	537	A13A-077-30	CUP	CRISTHER	780
1072C-L4108BBF-02	IKONA	DOPO	537	A13A-1036-02	KRAO	INDELUZ	214
1073A-L3110A-50	TEC	EXO	377	A13A-1053A-01	COVER	INDELUZ	243
1073B-L3110A-50	TEC	EXO	267	A13A-631-01	INEL	INDELUZ	226
1073C-L3110A-50	TEC	EXO	315	A13A-929-01	DAIN	CRISTHER	646
1074A-VX35B-01-01	MISTRAL	EXO	438	A13A-929-02	DAIN	CRISTHER	646
1074A-VX35B-01-57	MISTRAL	EXO	438	A13A-929-03	DAIN	CRISTHER	646
1074A-VX35B-01-59	MISTRAL	EXO	438	A13A-929-47	DAIN	CRISTHER	646
1074A-VX35B-02-02	MISTRAL	EXO	438	A13A-929-90	DAIN	CRISTHER	646
1074A-VX35B-02-57	MISTRAL	EXO	438	A13B-	INEL	INDELUZ	85
1074A-VX35B-02-59	MISTRAL	EXO	438	A13B-1036-01	KRAO	INDELUZ	214
1074B-W4135B-01-01	MISTRAL	EXO	437	A13B-1036-02	KRAO	INDELUZ	214
1074B-W4135B-01-57	MISTRAL	EXO	437	A13B-1053A-01	COVER	INDELUZ	243
1074B-W4135B-01-59	MISTRAL	EXO	437	A13B-631-01	INEL	INDELUZ	226
1074B-W4135B-02-02	MISTRAL	EXO	437	A13B-929-01	DAIN	CRISTHER	646, 739
1074B-W4135B-02-57	MISTRAL	EXO	437	A13B-929-02	DAIN	CRISTHER	646, 739
1074B-W4135B-02-59	MISTRAL	EXO	437	A13B-929-03	DAIN	CRISTHER	646, 739
1075A-H20X1A-01	GEOMETRICAL	EXO	375	A13B-929-47	DAIN	CRISTHER	646, 739
1075A-H20X1A-50	GEOMETRICAL	EXO	375	A13B-929-90	DAIN	CRISTHER	646, 739
1075B-H20X1A-01	GEOMETRICAL	EXO	375	A13C-	INEL	INDELUZ	85
1075B-H20X1A-50	GEOMETRICAL	EXO	375	A13C-1036-02	KRAO	INDELUZ	215
1075C-H20X1A-01	GEOMETRICAL	EXO	375	A13C-1053A-01	COVER	INDELUZ	243
1075C-H20X1A-50	GEOMETRICAL	EXO	375	A13C-631-01	INEL	INDELUZ	226
1076A-L3105B-01	SIGN	EXO	265	A13D-	INEL	INDELUZ	85
1076A-L3105B-02	SIGN	EXO	265	A13D-1053A-01	COVER	INDELUZ	243
1076A-L3105B-46	SIGN	EXO	265	A13D-631-01	INEL	INDELUZ	226
1076B-L3105B-01	SIGN	EXO	265	A14A-409-05	NAPOLÉS/BELGRADO	DOPO	511
1076B-L3105B-02	SIGN	EXO	265	A14A-409-06	NAPOLÉS/BELGRADO	DOPO	511
1076B-L3105B-46	SIGN	EXO	265	A14A-409-08	NAPOLÉS/BELGRADO	DOPO	511
1077A-L3132B-01-02	VINYL	EXO	357	A14A-546-05	DONISI	DOPO	499
1077A-L3132B-01-47	VINYL	EXO	357	A14A-546-06	DONISI	DOPO	499
1077A-L3132B-01-T1	VINYL	EXO	357	A14A-546-07	DONISI	DOPO	499
1077B-L3144B-01-02	VINYL	EXO	357	A14A-738-00	HAITI/ATOLON	INDELUZ	91, 156
1077B-L3144B-01-47	VINYL	EXO	357	A14B-738-00	HAITI/ATOLON	INDELUZ	91, 156
1077B-L3144B-01-T1	VINYL	EXO	357	A14C-738-00	HAITI/ATOLON	INDELUZ	91, 156
A02A-004-00	POSTES	DOPO	587	A20A-715-01	FRED	EXO	359
A02A-406-00	ROUND	DOPO	605,606	A20A-715-02	FRED	EXO	359
A02B-004-00	POSTES	DOPO	587	A20A-715-03	FRED	EXO	359
A02C-004-00	POSTES	DOPO	587	A20A-783-39	MAB	INDELUZ	95
A02D-004-00	POSTES	DOPO	763	A20B-583-01	HIMMEL/SPLAT	INDELUZ	97, 233

REF.	FAM.	BRAND	PAG.
A20B-715-01	FRED	EXO	359
A20B-783-01	MAB	INDELUZ	95
A20B-804-38	SPLAT	INDELUZ	97
A20C-715-01	FRED	EXO	359
A20C-804-01	MAB/SPLAT	INDELUZ	95, 97
A22A-128-29	GLOBOS	DOPO	601
A22B-128-29	GLOBOS	DOPO	601
A22C-128-29	GLOBOS	DOPO	601
A22D-128-29	GLOBOS	DOPO	601
A22E-128-01	GLOBOS	DOPO	601
A22F-128-01	GLOBOS	DOPO	601
A22G-128-29	GLOBOS	DOPO	601
A22H-128-29	GLOBOS	DOPO	601
A23A-128-29	GLOBOS	DOPO	600
A23B-128-29	GLOBOS	DOPO	600
A23C-128-01	GLOBOS	DOPO	600
A23D-128-01	GLOBOS	DOPO	600
A23E-128-01	GLOBOS	DOPO	600
A23F-128-01	GLOBOS	DOPO	600
A23G-128-29	GLOBOS	DOPO	600
A23H-128-29	GLOBOS	DOPO	600
A23I-128-29	GLOBOS	DOPO	600
A26A-004-CA	FIRENZE	EXO	286
A26A-004-CB	FIRENZE	EXO	286
A26A-004-CC	FIRENZE	EXO	286
A26B-004-CA	FIRENZE/LARS	EXO	398,405
A26B-004-CB	FIRENZE	EXO	398
A26B-004-CC	FIRENZE/LARS	EXO	398,405
A26C-004-CA	FIRENZE	EXO	399
A26C-004-CB	FIRENZE	EXO	399
A26C-004-CC	FIRENZE	EXO	399
A26E-004-CA	A TU ESTILO	EXO	287
A26E-004-CC	A TU ESTILO	EXO	287
A26E-004-CE	A TU ESTILO	EXO	287
A26E-004-CJ	A TU ESTILO	EXO	287
A26E-004-CK	A TU ESTILO	EXO	287
A26E-004-HC	A TU ESTILO	EXO	287
A26G-004-CA	LARS	EXO	405
A26G-004-CC	LARS	EXO	405
A27A-004-CA	FIRENZE	EXO	286
A27A-004-CB	FIRENZE	EXO	286
A27A-004-CC	FIRENZE	EXO	286
A27B-004-CA	FIRENZE	EXO	398
A27B-004-CB	FIRENZE	EXO	398
A27B-004-CC	FIRENZE	EXO	398
A27C-004-CA	FIRENZE	EXO	399
A27C-004-CB	FIRENZE	EXO	399
A27C-004-CC	FIRENZE	EXO	399
A29B-004-CA	AMSTERDAM/KARA	EXO	395, 407
A29B-004-CB	AMSTERDAM/KARA	EXO	395,409
A29B-004-CG	AMSTERDAM/KARA	EXO	395, 407
A29B-004-DC	WOOD / KARA	EXO	407,409
A29C-004-CA	AMSTERDAM/KARA	EXO	394, 407
A29C-004-CB	AMSTERDAM/KARA	EXO	394,408
A29C-004-CG	AMSTERDAM/KARA	EXO	394, 407
A29C-004-DC	WOOD / KARA	EXO	407,408
A32A-004-CA	FIRENZE / EASY	EXO	353, 369
A32A-004-CB	FIRENZE / EASY	EXO	353, 369
A32A-004-CC	FIRENZE / EASY	EXO	353, 369
A32B-004-CA	A TU ESTILO	EXO	360
A32B-004-CC	A TU ESTILO	EXO	360
A32B-004-CE	A TU ESTILO	EXO	360

REF.	FAM.	BRAND	PAG.
A32B-004-CJ	A TU ESTILO	EXO	360
A32B-004-CK	A TU ESTILO	EXO	360
A32B-004-HC	A TU ESTILO	EXO	360
A32C-004-CA	A TU ESTILO	EXO	360
A32C-004-CC	A TU ESTILO	EXO	360
A32C-004-CE	A TU ESTILO	EXO	360
A32C-004-CJ	A TU ESTILO	EXO	360
A32C-004-CK	A TU ESTILO	EXO	360
A32C-004-HC	A TU ESTILO	EXO	360
A32D-004-CA	A TU ESTILO	EXO	360
A32D-004-CC	A TU ESTILO	EXO	360
A32D-004-CE	A TU ESTILO	EXO	360
A32D-004-CJ	A TU ESTILO	EXO	360
A32D-004-CK	A TU ESTILO	EXO	360
A32D-004-HC	A TU ESTILO	EXO	360
A35A-004-CA	BRITTA	EXO	403
A35C-004-CA	BRITTA	EXO	283,402
A44A-772-01	HAITI/ATOLON	INDELUZ	91, 156
A44A-772-02	HAITI/ATOLON	INDELUZ	91, 156
A44A-772-03	HAITI/ATOLON	INDELUZ	91, 156
A45A-738-01	ATOLON	INDELUZ	91, 219
A45A-738-02	ATOLON	INDELUZ	91, 219
A45A-738-03	ATOLON	INDELUZ	91, 219
A45B-738-01	ATOLON	INDELUZ	91, 219
A45B-738-02	ATOLON	INDELUZ	91, 219
A45B-738-03	ATOLON	INDELUZ	91, 219
A45C-738-01	ATOLON	INDELUZ	91, 219
A45C-738-02	ATOLON	INDELUZ	91, 219
A45C-738-03	ATOLON	INDELUZ	91, 219
A45D-738-01	ATOLON	INDELUZ	91, 219
A45D-738-02	ATOLON	INDELUZ	91, 219
A45D-738-03	ATOLON	INDELUZ	91, 219
A45E-738-01	ATOLON	INDELUZ	91, 219
A45E-738-02	ATOLON	INDELUZ	91, 219
A45E-738-03	ATOLON	INDELUZ	91, 219
A47C-796-92	DUBE	INDELUZ	144
A47D-796-92	DUBE	INDELUZ	144
A47E-796-92	DUBE	INDELUZ	144
A47F-1002-92	ACCESORIOS	INDELUZ	50, 140
A47G-1003-92	ACCESORIOS	INDELUZ	142
A47H-1004-92	ACCESORIOS	INDELUZ	50
A47Q-1006-92	VIP	INDELUZ	59
A47R-1006-92	VIP	INDELUZ	59
A47T-1006-92	VIP	INDELUZ	59
A50A-778-39	PERFILES	INDELUZ	196
A50C-778-00	PERFILES	INDELUZ	196, 197
A50D-778-00	PERFILES	INDELUZ	196, 197
A50G-778-03	PERFILES	INDELUZ	196
A50H-778-03	PERFILES	INDELUZ	196
A50I-778-00	PERFILES	INDELUZ	196
A51A-778-39	PERFILES	INDELUZ	198
A51G-778-03	PERFILES	INDELUZ	198
A51H-778-03	PERFILES	INDELUZ	198
A51I-778-00	PERFILES	INDELUZ	198
A52A-778-39	PERFILES	INDELUZ	197
A52G-778-03	PERFILES	INDELUZ	197
A52H-778-03	PERFILES	INDELUZ	197
A52I-778-00	PERFILES	INDELUZ	197
A55A-796-02	DUBE	INDELUZ	144
A55A-796-45	DUBE	INDELUZ	144
A55A-796-46	DUBE	INDELUZ	144
A58C-808-41	FENIX	INDELUZ	117

REF.	FAM.	BRAND	PAG.	REF.	FAM.	BRAND	PAG.
A58E-1061-41	FENIX	INDELUZ	107	A69C-778-00	PERFILES	INDELUZ	200
A58F-1061-41	FENIX	INDELUZ	111	A69D-778-00	PERFILES	INDELUZ	200
A60A-825-01	LAND	INDELUZ	155	A69G-778-03	PERFILES	INDELUZ	200
A60A-825-02	LAND	INDELUZ	155	A69H-778-03	PERFILES	INDELUZ	200
A60B-825-01	LAND	INDELUZ	155	A69I-778-00	PERFILES	INDELUZ	200
A60B-825-02	LAND	INDELUZ	155	A69J-778-00	PERFILES	INDELUZ	200
A60C-825-01	LAND	INDELUZ	155	A70A-778-39	PERFILES	INDELUZ	200
A60C-825-02	LAND	INDELUZ	155	A70C-778-00	PERFILES	INDELUZ	200
A60D-825-02	LAND	INDELUZ	155	A70D-778-00	PERFILES	INDELUZ	200
A61A-786-01	TRACK	INDELUZ	255, 257	A70G-778-03	PERFILES	INDELUZ	200
A61A-786-02	TRACK	INDELUZ	255, 257	A70H-778-03	PERFILES	INDELUZ	200
A61A-786-03	TRACK	INDELUZ	255, 257	A71A-778-39	PERFILES	INDELUZ	197
A61B-786-01	TRACK	INDELUZ	255, 257	A71C-778-00	PERFILES	INDELUZ	197, 199
A61B-786-02	TRACK	INDELUZ	255, 257	A71D-778-00	PERFILES	INDELUZ	197, 199
A61B-786-03	TRACK	INDELUZ	255, 257	A71G-778-03	PERFILES	INDELUZ	197
A61C-786-01	TRACK	INDELUZ	255, 257	A71H-778-03	PERFILES	INDELUZ	197
A61C-786-02	TRACK	INDELUZ	255, 257	A71I-778-00	PERFILES	INDELUZ	197
A61D-786-01	TRACK	INDELUZ	255, 257	A72A-778-39	PERFILES	INDELUZ	199
A61D-786-02	TRACK	INDELUZ	255, 257	A72G-778-03	PERFILES	INDELUZ	199
A61E-786-01	TRACK	INDELUZ	255, 257	A72H-778-03	PERFILES	INDELUZ	199
A61E-786-02	TRACK	INDELUZ	255, 257	A72I-778-00	PERFILES	INDELUZ	199
A61E-786-03	TRACK	INDELUZ	255, 257	A73A-1032-01	TRACK 48V	INDELUZ	169, 173
A61G-786-01	TRACK	INDELUZ	254, 256	A73A-1032-02	TRACK 48V	INDELUZ	169, 173
A61G-786-02	TRACK	INDELUZ	254, 256	A73B-1032-01	TRACK 48V	INDELUZ	169, 173
A61G-786-03	TRACK	INDELUZ	254, 256	A73B-1032-02	TRACK 48V	INDELUZ	169, 173
A61H-786-01	TRACK	INDELUZ	255	A73C-1032-01	TRACK 48V	INDELUZ	167
A61H-786-02	TRACK	INDELUZ	255	A73C-1032-02	TRACK 48V	INDELUZ	167
A61H-786-03	TRACK	INDELUZ	255	A73D-1032-01	TRACK 48V	INDELUZ	167
A61H-786-39	TRACK	INDELUZ	255, 257	A73D-1032-02	TRACK 48V	INDELUZ	167
A61J-786-01	TRACK	INDELUZ	255	A73E-1032-01	TRACK 48V	INDELUZ	171
A61J-786-02	TRACK	INDELUZ	255	A73E-1032-02	TRACK 48V	INDELUZ	171
A61J-786-03	TRACK	INDELUZ	255	A73F-1032-38	TRACK 48V	INDELUZ	173
A61K-786-01	TRACK	INDELUZ	257	A73G-1032-38	TRACK 48V	INDELUZ	167, 169
A61K-786-02	TRACK	INDELUZ	257	A73H-1032-38	TRACK 48V	INDELUZ	167, 169
A61K-786-03	TRACK	INDELUZ	257	A73J-1032-01	TRACK 48V	INDELUZ	171, 173
A61L-786-01	TRACK	INDELUZ	257	A73J-1032-02	TRACK 48V	INDELUZ	171, 173
A61L-786-02	TRACK	INDELUZ	257	A73L-1032-01	TRACK 48V	INDELUZ	169
A61L-786-03	TRACK	INDELUZ	257	A73L-1032-02	TRACK 48V	INDELUZ	169
A61M-786-03	TRACK	INDELUZ	255, 257	A73M-1032-01	TRACK 48V	INDELUZ	169
A61N-786-00	TRACK	INDELUZ	255, 257	A73M-1032-02	TRACK 48V	INDELUZ	169
A63A-778-39	PERFILES	INDELUZ	196	A73N-1032-01	TRACK 48V	INDELUZ	173
A63G-778-03	PERFILES	INDELUZ	196	A73N-1032-02	TRACK 48V	INDELUZ	173
A63H-778-03	PERFILES	INDELUZ	196	A73P-1032-01	TRACK 48V	INDELUZ	173
A63I-778-00	PERFILES	INDELUZ	196	A73P-1032-02	TRACK 48V	INDELUZ	173
A64A-778-39	PERFILES	INDELUZ	198	A73Q-1032-01	TRACK 48V	INDELUZ	173
A64G-778-03	PERFILES	INDELUZ	198	A73Q-1032-02	TRACK 48V	INDELUZ	173
A64H-778-03	PERFILES	INDELUZ	198	A73R-1032-01	TRACK 48V	INDELUZ	167
A64I-778-00	PERFILES	INDELUZ	198	A73R-1032-02	TRACK 48V	INDELUZ	167
A66A-778-39	PERFILES	INDELUZ	197	A73S-1032-01	TRACK 48V	INDELUZ	167
A66C-778-00	PERFILES	INDELUZ	197	A73S-1032-02	TRACK 48V	INDELUZ	167
A66D-778-00	PERFILES	INDELUZ	197	A73T-1032-01	TRACK 48V	INDELUZ	169, 171
A66G-778-03	PERFILES	INDELUZ	197	A73T-1032-02	TRACK 48V	INDELUZ	169, 171
A66H-778-03	PERFILES	INDELUZ	197	A73U-1032-01	TRACK 48V	INDELUZ	167, 169
A66I-778-00	PERFILES	INDELUZ	197	A73V-1032-39	TRACK 48V	INDELUZ	173
A67A-778-39	PERFILES	INDELUZ	196	A73X-1032-38	TRACK 48V	INDELUZ	173
A68A-778-39	PERFILES	INDELUZ	199	A73Y-1032-38	TRACK 48V	INDELUZ	171
A68C-778-00	PERFILES	INDELUZ	199	B01A-X33X2A-03	PAR 56 LED	CRISTHER	776
A68D-778-00	PERFILES	INDELUZ	199	B02A-X3317H-01	ALIMENTADORES	NX Lighting	668, 794
A68G-778-03	PERFILES	INDELUZ	199	B02A-X3317J-01	ALIMENTADORES	NX Lighting	794
A68H-778-03	PERFILES	INDELUZ	199	B02A-X3320I-01	ALIMENTADORES	NX Lighting	674, 794
A68I-778-00	PERFILES	INDELUZ	199	B02A-X33X2F-01	ALIMENTADORES	NX Lighting	669, 795
A69A-778-39	PERFILES	INDELUZ	200	B02B-X3360B-01	ALIMENTADORES	NX Lighting	794

REF.	FAM.	BRAND	PAG.
B02B-X33A4B-01	ALIMENTADORES	NX Lighting	794
B02C-X3330F-00	ALIMENTADORES	INDELUZ	211, 795
B02C-X3360F-00	ALIMENTADORES	INDELUZ	211, 795
B02C-X3375F-00	ALIMENTADORES	INDELUZ	211, 795
B02C-X33A3F-00	ALIMENTADORES	INDELUZ	211, 795
B02C-X33A7D-02	ALIMENTADORES	NX Lighting	794
B02E-X3330E-00	ALIMENTADORES	NX Lighting	721, 794
B02E-X3375E-00	ALIMENTADORES	NX Lighting	721, 794
B02F-X33A8D-32	ALIMENTADORES	NX Lighting	794
B02G-X3306J-01	ALIMENTADORES	NX Lighting	794
B02H-X3360F-00	ALIMENTADORES	INDELUZ	211, 795
B02H-X3390F-00	ALIMENTADORES	INDELUZ	211, 795
B02H-X33A3F-00	ALIMENTADORES	INDELUZ	211, 795
B02H-X33A5F-00	ALIMENTADORES	INDELUZ	211, 795
B02I-X33F9D-02	ALIMENTADORES	NX Lighting	774, 794
B02I-X33G1D-02	ALIMENTADORES	NX Lighting	774, 794
B02J-X3350D-02	ALIMENTADORES	NX Lighting	786, 794
B02L-X3340F-00	ALIMENTADORES	INDELUZ	211
B02L-X3380F-01	ALIMENTADORES	INDELUZ	211
B02L-X33A4F-02	ALIMENTADORES	INDELUZ	211
B02L-X33A6F-03	ALIMENTADORES	INDELUZ	211
B02M-X33A5D-03	ALIMENTADORES	NX Lighting	794
B02M-X33A9D-03	ALIMENTADORES	NX Lighting	794
B02N-X3330J-01	ALIMENTADORES	NX Lighting	675, 794
B02N-X3340M-01	ALIMENTADORES	NX Lighting	794
B02P-X3326H-01	ALIMENTADORES	NX Lighting	674, 794
B02P-X3340JM-01	ALIMENTADORES	NX Lighting	675, 794
B02Q-X3312F-01	ALIMENTADORES	NX Lighting	699, 795
B02Q-X3325F-01	ALIMENTADORES	NX Lighting	694, 795
B02Q-X3335F-00	ALIMENTADORES	INDELUZ	211, 795
B02Q-X3396F-00	ALIMENTADORES	INDELUZ	211, 795
B02R-X3335F-00	ALIMENTADORES	INDELUZ	211, 795
B02R-X3360F-00	ALIMENTADORES	INDELUZ	211, 795
B02R-X33A1F-01	ALIMENTADORES	INDELUZ	211, 795
B02R-X33A4F-00	ALIMENTADORES	INDELUZ	211, 795
B02V-X3375V-00	ALIMENTADORES	INDELUZ	795
B02V-X33J5F-00	ALIMENTADORES	INDELUZ	211
B02V-X33J5V-00	ALIMENTADORES	INDELUZ	795
B02Y-X3330F-00	ALIMENTADORES	INDELUZ	211, 795
B02Y-X3375F-00	ALIMENTADORES	INDELUZ	211, 795
B02Y-X33A1F-00	ALIMENTADORES	INDELUZ	211, 795
B02Y-X33A4F-00	ALIMENTADORES	INDELUZ	211, 795
B02Y-X33A6F-00	ALIMENTADORES	INDELUZ	211
B03A-X33X2A-02	CONECTORES	NX Lighting	793
B03B-X33X2A-02	CONECTORES	NX Lighting	793
B03C-X33X2A-02	CONECTORES	NX Lighting	793
B03D-X33X2A-02	CONECTORES	NX Lighting	793
B03F-X33X1A-29	POSTES	DOPO	603, 763
B03G-X33X2A-02	CONECTORES	NX Lighting	793
B03H-X33X2A-02	CONECTORES	NX Lighting	793
B03I-X33X2A-02	CONECTORES	NX Lighting	793
B03J-X33X2A-02	CONECTORES	NX Lighting	793
B05A-X33X2X-02	PAR 56 LED	CRISTHER	776
B05B-X33X2B-01	PAR 56 LED	CRISTHER	776
B12A-G05X1A-02	GLOBOS	DOPO	601
B12F-G05X1A-02	GLOBOS	DOPO	601
B12G-G05X1A-02	GLOBOS	DOPO	601
B12H-G05X1A-02	GLOBOS	DOPO	601
B12I-G05X1A-02	GLOBOS	DOPO	604
B12J-G05X1A-01	GLOBOS	DOPO	600
B12J-G05X1A-02	GLOBOS	DOPO	600
B12K-G05X1A-01	GLOBOS	DOPO	600

REF.	FAM.	BRAND	PAG.
B12K-G05X1A-02	GLOBOS	DOPO	600
B12L-G05X1A-01	GLOBOS	DOPO	600
B12L-G05X1A-02	GLOBOS	DOPO	600
B12M-G05X1A-02	GLOBOS	DOPO	601
B17F-X33X2B-01	TRACK	INDELUZ	255
B17F-X33X2B-02	TRACK	INDELUZ	255
B17F-X33X2B-03	TRACK	INDELUZ	255
B17O-X33X2B-01	TRACK	INDELUZ	255
B17O-X33X2B-02	TRACK	INDELUZ	255
B17P-X33X2B-01	ACCESORIOS	EXO	331
B17P-X33X2B-02	ACCESORIOS	EXO	331
B17P-X33X2B-03	ACCESORIOS	EXO	331
B19A-X3310B-01	DUBE	INDELUZ	145
B19A-X3310B-02	DUBE	INDELUZ	145
B19B-X3340B-01	DUBE	INDELUZ	145
B19B-X3340B-02	DUBE	INDELUZ	145
B19C-X3330B-01	DUBE	INDELUZ	145
B19C-X3330B-02	DUBE	INDELUZ	145
B19E-X3310B-01	DUBE	INDELUZ	145
B19E-X3310B-02	DUBE	INDELUZ	145
B19F-X3330B-01	DUBE	INDELUZ	145
B19F-X3330B-02	DUBE	INDELUZ	145
B19G-X3315A-01	DUBE	INDELUZ	145
B19G-X3315A-02	DUBE	INDELUZ	145
B19G-X3318B-01	DUBE	INDELUZ	145
B19G-X3318B-02	DUBE	INDELUZ	145
B19G-X3330B-01	DUBE	INDELUZ	145
B19G-X3330B-02	DUBE	INDELUZ	145
B19G-X3330B-03	DUBE	INDELUZ	145
B19G-X3330B-04	DUBE	INDELUZ	145
B19G-X3330B-05	DUBE	INDELUZ	145
B19G-X3330B-06	DUBE	INDELUZ	145
B19G-X3330B-07	DUBE	INDELUZ	145
B19G-X3330B-08	DUBE	INDELUZ	145
B19G-X3330B-09	DUBE	INDELUZ	145
B19G-X3330B-10	DUBE	INDELUZ	145
B19G-X3330B-11	DUBE	INDELUZ	145
B19G-X3330B-12	DUBE	INDELUZ	145
B19G-X3330B-13	DUBE	INDELUZ	145
B19G-X3330B-14	DUBE	INDELUZ	145
B19G-X3330B-15	DUBE	INDELUZ	145
B19G-X3330B-16	DUBE	INDELUZ	145
B19G-X3330B-17	DUBE	INDELUZ	145
B19G-X3330B-18	DUBE	INDELUZ	145
B19G-X3330B-19	DUBE	INDELUZ	145
B19G-X3330B-20	DUBE	INDELUZ	145
B19G-X3330B-21	DUBE	INDELUZ	145
B19G-X3330B-22	DUBE	INDELUZ	145
B19G-X3330B-23	DUBE	INDELUZ	145
B19G-X3330B-24	DUBE	INDELUZ	145
B19G-X3330B-25	DUBE	INDELUZ	145
B19G-X3330B-26	DUBE	INDELUZ	145
B19G-X3330B-27	DUBE	INDELUZ	145
B19G-X3330B-28	DUBE	INDELUZ	145
B19G-X3330B-29	DUBE	INDELUZ	145
B19G-X3330B-30	DUBE	INDELUZ	145
B19G-X3330B-31	DUBE	INDELUZ	145
B19G-X3330B-32	DUBE	INDELUZ	145
B19G-X3330B-33	DUBE	INDELUZ	145
B19G-X3330B-34	DUBE	INDELUZ	145
B19G-X3330B-35	DUBE	INDELUZ	145
B19G-X3330B-36	DUBE	INDELUZ	145
B19G-X3330B-37	DUBE	INDELUZ	145
B19G-X3330B-38	DUBE	INDELUZ	145
B19G-X3330B-39	DUBE	INDELUZ	145
B19G-X3330B-40	DUBE	INDELUZ	145
B19G-X3330B-41	DUBE	INDELUZ	145
B19G-X3330B-42	DUBE	INDELUZ	145
B19G-X3330B-43	DUBE	INDELUZ	145
B19G-X3330B-44	DUBE	INDELUZ	145
B19G-X3330B-45	DUBE	INDELUZ	145
B19G-X3330B-46	DUBE	INDELUZ	145
B19G-X3330B-47	DUBE	INDELUZ	145
B19G-X3330B-48	DUBE	INDELUZ	145
B19G-X3330B-49	DUBE	INDELUZ	145
B19G-X3330B-50	DUBE	INDELUZ	145
B19G-X3330B-51	DUBE	INDELUZ	145
B19G-X3330B-52	DUBE	INDELUZ	145
B19G-X3330B-53	DUBE	INDELUZ	145
B19G-X3330B-54	DUBE	INDELUZ	145
B19G-X3330B-55	DUBE	INDELUZ	145
B19G-X3330B-56	DUBE	INDELUZ	145
B19G-X3330B-57	DUBE	INDELUZ	145
B19G-X3330B-58	DUBE	INDELUZ	145
B19G-X3330B-59	DUBE	INDELUZ	145
B19G-X3330B-60	DUBE	INDELUZ	145
B19G-X3330B-61	DUBE	INDELUZ	145
B19G-X3330B-62	DUBE	INDELUZ	145
B19G-X3330B-63	DUBE	INDELUZ	145
B19G-X3330B-64	DUBE	INDELUZ	145
B19G-X3330B-65	DUBE	INDELUZ	145
B19G-X3330B-66	DUBE	INDELUZ	145
B19G-X3330B-67	DUBE	INDELUZ	145
B19G-X3330B-68	DUBE	INDELUZ	145
B19G-X3330B-69	DUBE	INDELUZ	145
B19G-X3330B-70	DUBE	INDELUZ	145
B19G-X3330B-71	DUBE	INDELUZ	145
B19G-X3330B-72	DUBE	INDELUZ	145
B19G-X3330B-73	DUBE	INDELUZ	145
B19G-X3330B-74	DUBE	INDELUZ	145
B19G-X3330B-75	DUBE	INDELUZ	145
B19G-X3330B-76	DUBE	INDELUZ	145
B19G-X3330B-77	DUBE	INDELUZ	145
B19G-X3330B-78	DUBE	INDELUZ	145
B19G-X3330B-79	DUBE	INDELUZ	145
B19G-X3330B-80	DUBE	INDELUZ	145
B19G-X3330B-81	DUBE	INDELUZ	145
B19G-X3330B-82	DUBE	INDELUZ	145
B19G-X3330B-83	DUBE	INDELUZ	145
B19G-X3330B-84	DUBE	INDELUZ	145
B19G-X3330B-85	DUBE	INDELUZ	145
B19G-X3330B-86	DUBE	INDELUZ	145
B19G-X3330B-87	DUBE	INDELUZ	145
B19G-X3330B-88	DUBE	INDELUZ	145
B19G-X3330B-89	DUBE	INDELUZ	145
B19G-X3330B-90	DUBE	INDELUZ	145
B19G-X3330B-91	DUBE	INDELUZ	145
B19G-X3330B-92	DUBE	INDELUZ	145
B19G-X3330B-93	DUBE	INDELUZ	145
B19G-X3330B-94	DUBE	INDELUZ	145
B19G-X3330B-95	DUBE	INDELUZ	145
B19G-X3330B-96	DUBE	INDELUZ	145
B19G-X3330B-97	DUBE	INDELUZ	145
B19G-X3330B-98	DUBE	INDELUZ	145
B19G-X3330B-99	DUBE	INDELUZ	145
B19G-X3330B-100	DUBE	INDELUZ	145
B25-X33X2B-01	ENIGMA/FALL	INDELUZ	151, 251
B25-X33X2B-02	ENIGMA/FALL	INDELUZ	151, 251
B28A-X33X2B-01	TRACK	INDELUZ	254
B28A-X33X2B-02	TRACK	INDELUZ	254
B28A-X33X2B-39	TRACK	INDELUZ	254
B28B-X33X2B-01	TRACK	INDELUZ	254
B28B-X33X2B-02	TRACK	INDELUZ	254
B28B-X33X2B-39	TRACK	INDELUZ	254
B28C-X33X2B-01	TRACK	INDELUZ	254
B28C-X33X2B-02	TRACK	INDELUZ	254
B28C-X33X2B-39	TRACK	INDELUZ	254
B28D-X33X2B-01	TRACK	INDELUZ	254
B28D-X33X2B-02	TRACK	INDELUZ	254
B28D-X33X2B-03	TRACK	INDELUZ	254
B28E-X33X2B-01	TRACK	INDELUZ	254
B28E-X33X2B-02	TRACK	INDELUZ	254
B28E-X33X2B-03	TRACK	INDELUZ	254
B28G-X33X2B-01	TRACK	INDELUZ	254
B28G-X33X2B-02	TRACK	INDELUZ	254
B28G-X33X2B-03	TRACK	INDELUZ	254
B28H-X33X2B-01	TRACK	INDELUZ	254
B28H-X33X2B-02	TRACK	INDELUZ	254
B28H-X33X2B-03	TRACK	INDELUZ	254
B28I-X33X2B-01	TRACK	INDELUZ	254
B28I-X33X2B-02	TRACK	INDELUZ	254
B28I-X33X2B-03	TRACK	INDELUZ	254
B28J-X33X2B-01	TRACK	INDELUZ	254
B28J-X33X2B-02	TRACK	INDELUZ	254

REF.	FAM.	BRAND	PAG.	REF.	FAM.	BRAND	PAG.
B28J-X33X2B-03	TRACK	INDELUZ	254	B31B-X33X2U-02	TRACK	INDELUZ	256
B28K-X33X2B-01	TRACK	INDELUZ	254	B31B-X33X2U-39	TRACK	INDELUZ	256
B28K-X33X2B-02	TRACK	INDELUZ	254	B31C-X33X2U-01	TRACK	INDELUZ	256
B28K-X33X2B-03	TRACK	INDELUZ	254	B31C-X33X2U-02	TRACK	INDELUZ	256
B28L-X33X2B-01	TRACK	INDELUZ	254	B31C-X33X2U-39	TRACK	INDELUZ	256
B28L-X33X2B-02	TRACK	INDELUZ	254	B32A-X33X2V-01	TRACK 48V	INDELUZ	166
B28L-X33X2B-03	TRACK	INDELUZ	254	B32A-X33X2V-02	TRACK 48V	INDELUZ	166
B28M-X33X2B-01	TRACK	INDELUZ	254	B32B-X33X2V-01	TRACK 48V	INDELUZ	166
B28M-X33X2B-02	TRACK	INDELUZ	254	B32B-X33X2V-02	TRACK 48V	INDELUZ	166
B28M-X33X2B-03	TRACK	INDELUZ	254	B32C-X33X2V-01	TRACK 48V	INDELUZ	166
B28N-X33X2B-01	TRACK	INDELUZ	254	B32C-X33X2V-02	TRACK 48V	INDELUZ	166
B28N-X33X2B-02	TRACK	INDELUZ	254	B32D-X33X2V-01	TRACK 48V	INDELUZ	167, 169
B28N-X33X2B-03	TRACK	INDELUZ	254	B32D-X33X2V-02	TRACK 48V	INDELUZ	167, 169
B29A-X33X2U-01	TRACK	INDELUZ	256	B32E-X33X2V-01	TRACK 48V	INDELUZ	167, 169
B29A-X33X2U-02	TRACK	INDELUZ	256	B32E-X33X2V-02	TRACK 48V	INDELUZ	167, 169
B29A-X33X2U-39	TRACK	INDELUZ	256	B32F-X33X2V-01	TRACK 48V	INDELUZ	167, 169
B29B-X33X2U-01	TRACK	INDELUZ	256	B32F-X33X2V-02	TRACK 48V	INDELUZ	167, 169
B29B-X33X2U-02	TRACK	INDELUZ	256	B32G-X33X2V-01	TRACK 48V	INDELUZ	167, 169
B29B-X33X2U-39	TRACK	INDELUZ	256	B32G-X33X2V-02	TRACK 48V	INDELUZ	167, 169
B29C-X33X2U-01	TRACK	INDELUZ	256	B32H-X33X2V-01	TRACK 48V	INDELUZ	167, 169
B29C-X33X2U-02	TRACK	INDELUZ	256	B32H-X33X2V-02	TRACK 48V	INDELUZ	167, 169
B29C-X33X2U-39	TRACK	INDELUZ	256	B32J-X33X2V-01	TRACK 48V	INDELUZ	167, 169
B29D-X33X2U-01	TRACK	INDELUZ	256	B32J-X33X2V-02	TRACK 48V	INDELUZ	167, 169
B29D-X33X2U-02	TRACK	INDELUZ	256	B32K-X33X2V-01	TRACK 48V	INDELUZ	167, 169
B29D-X33X2U-03	TRACK	INDELUZ	256	B32K-X33X2V-02	TRACK 48V	INDELUZ	167, 169
B29E-X33X2U-01	TRACK	INDELUZ	256	B32L-X33A1V-01	TRACK 48V	INDELUZ	167, 169
B29E-X33X2U-02	TRACK	INDELUZ	256	B32L-X33A1V-02	TRACK 48V	INDELUZ	167, 169
B29E-X33X2U-03	TRACK	INDELUZ	256	B32M-X33A1V-01	TRACK 48V	INDELUZ	167, 169
B29F-X33X2U-01	TRACK	INDELUZ	256	B32M-X33A1V-02	TRACK 48V	INDELUZ	167, 169
B29F-X33X2U-02	TRACK	INDELUZ	256	B32N-X33A1V-02	TRACK 48V	INDELUZ	795
B29F-X33X2U-03	TRACK	INDELUZ	256	B32N-X33A6V-02	TRACK 48V	INDELUZ	795
B29H-X33X2U-01	TRACK	INDELUZ	256	B33A-X33X2V-01	TRACK 48V	INDELUZ	170
B29H-X33X2U-02	TRACK	INDELUZ	256	B33A-X33X2V-02	TRACK 48V	INDELUZ	170
B29H-X33X2U-03	TRACK	INDELUZ	256	B33B-X33X2V-01	TRACK 48V	INDELUZ	170
B29I-X33X2U-01	TRACK	INDELUZ	257	B33B-X33X2V-02	TRACK 48V	INDELUZ	170
B29I-X33X2U-02	TRACK	INDELUZ	257	B33C-X33X2V-01	TRACK 48V	INDELUZ	170
B29I-X33X2U-03	TRACK	INDELUZ	257	B33C-X33X2V-02	TRACK 48V	INDELUZ	170
B29J-X33X2U-01	TRACK	INDELUZ	256	B34A-X33X2V-01	TRACK 48V	INDELUZ	168
B29J-X33X2U-02	TRACK	INDELUZ	256	B34A-X33X2V-02	TRACK 48V	INDELUZ	168
B29J-X33X2U-03	TRACK	INDELUZ	256	B34B-X33X2V-01	TRACK 48V	INDELUZ	168
B29K-X33X2U-01	TRACK	INDELUZ	257	B34B-X33X2V-02	TRACK 48V	INDELUZ	168
B29K-X33X2U-02	TRACK	INDELUZ	257	B34C-X33X2V-01	TRACK 48V	INDELUZ	168
B29K-X33X2U-03	TRACK	INDELUZ	257	B34C-X33X2V-02	TRACK 48V	INDELUZ	168
B29L-X33X2U-01	TRACK	INDELUZ	256	B35A-X33X2V-01	TRACK 48V	INDELUZ	172
B29L-X33X2U-02	TRACK	INDELUZ	256	B35A-X33X2V-02	TRACK 48V	INDELUZ	172
B29L-X33X2U-03	TRACK	INDELUZ	256	B35B-X33X2V-01	TRACK 48V	INDELUZ	172
B29M-X33X2U-01	TRACK	INDELUZ	256	B35B-X33X2V-02	TRACK 48V	INDELUZ	172
B29M-X33X2U-02	TRACK	INDELUZ	256	B35C-X33X2V-01	TRACK 48V	INDELUZ	172
B29M-X33X2U-03	TRACK	INDELUZ	256	B35C-X33X2V-02	TRACK 48V	INDELUZ	172
B30A-X33X2B-01	TRACK	INDELUZ	254	B61A-	FENIX	INDELUZ	109
B30A-X33X2B-02	TRACK	INDELUZ	254	B64A-	FENIX	INDELUZ	117
B30A-X33X2B-39	TRACK	INDELUZ	254	B65A-	FENIX	INDELUZ	111
B30B-X33X2B-01	TRACK	INDELUZ	254	Base-Nb	POSTES	DOPO	587
B30B-X33X2B-02	TRACK	INDELUZ	254	Base-Nn	POSTES	DOPO	587
B30B-X33X2B-39	TRACK	INDELUZ	254	Base-Rb	POSTES	DOPO	587
B30C-X33X2B-01	TRACK	INDELUZ	254	Base-Rn	POSTES	DOPO	587
B30C-X33X2B-02	TRACK	INDELUZ	254	Base-Vb	POSTES	DOPO	587
B30C-X33X2B-39	TRACK	INDELUZ	254	Base-Vn	POSTES	DOPO	587
B31A-X33X2U-01	TRACK	INDELUZ	256	C02B-32-02	POSTES	DOPO	602, 763
B31A-X33X2U-02	TRACK	INDELUZ	256	C02C-32-02	POSTES	DOPO	602, 763
B31A-X33X2U-39	TRACK	INDELUZ	256	C02D-32-02	POSTES	DOPO	602, 763
B31B-X33X2U-01	TRACK	INDELUZ	256	C02F-32-02	POSTES	DOPO	602, 763



REF.	FAM.	BRAND	PAG.
C03B-32-39	POSTES	DOPO	602, 763
C03C-32-39	POSTES	DOPO	602, 763
C03D-32-39	POSTES	DOPO	602, 763
C03F-32-39	POSTES	DOPO	602, 763
C04A-32-02	POSTES	DOPO	602, 763
C04B-32-02	POSTES	DOPO	602, 763
C04C-32-02	POSTES	DOPO	602, 763
C04D-32-02	POSTES	DOPO	602, 763
C04E-32-02	POSTES	DOPO	602, 763
C06A-31-02	POSTES	DOPO	602
C06B-31-02	POSTES	DOPO	602
C07A-11-01	POSTES	DOPO	591
C07A-11-02	POSTES	DOPO	591
C07B-12-01	POSTES	DOPO	591
C07B-12-02	POSTES	DOPO	591
C07C-12-01	POSTES	DOPO	591
C07C-12-02	POSTES	DOPO	591
C07D-42-02	POSTES	DOPO	604
C07E-42-02	POSTES	DOPO	604
C07F-42-02	POSTES	DOPO	604
C08B-31-02	POSTES	DOPO	594
C08C-31-02	POSTES	DOPO	594
C10A-31-02	POSTES	DOPO	595, 615
C10B-31-02	POSTES	DOPO	595, 615
C12A-32-02	POSTES	DOPO	615
C12B-32-02	POSTES	DOPO	615
C12C-32-02	POSTES	DOPO	615
C30B-31-38	POSTES	DOPO	603
C30D-31-38	POSTES	DOPO	603
C30E-31-38	POSTES	DOPO	603
C30E-32-38	POSTES	DOPO	603
C30F-31-38	POSTES	DOPO	603
C30F-32-38	POSTES	DOPO	603
CAB.SET.13.VOLGA	VOLGA	INDELUZ	194
CAB.SET.19.VOLGA	VOLGA	INDELUZ	195
CEM-1069-02	DUOMO	CRISTHER	733
CONAC-B03A-KIT	CONECTORES	INDELUZ	190
CONAC-B03B-KIT	CONECTORES	INDELUZ	190
CONAS-B03A-KIT	CONECTORES	INDELUZ	176
CONAS-B03B-KIT	CONECTORES	INDELUZ	176
CONDS-B03A-KIT	CONECTORES	INDELUZ	177
CONDS-B03B-KIT	CONECTORES	INDELUZ	177
CONT.CBU-PWM4	CONTROLADORES	INDELUZ	206
CONT.DA1	CONTROLADORES	INDELUZ	210
CONT.DA4	CONTROLADORES	INDELUZ	210
CONT.DT	CONTROLADORES	INDELUZ	210
CONT.EV1-S	CONTROLADORES	INDELUZ	210
CONT.EV4	CONTROLADORES	INDELUZ	210
CONT.L1WT	CONTROLADORES	INDELUZ	209
CONT.R9*XC	CONTROLADORES	NX Lighting	701, 703
CONT.RT10	CONTROLADORES	INDELUZ	202
CONT.T15	CONTROLADORES	INDELUZ	202
CONT.V1	CONTROLADORES	INDELUZ	203
CONT.V2-L	CONTROLADORES	INDELUZ	203
CONT.V4	CONTROLADORES	INDELUZ	204
CONT.V4WP	CONTROLADORES	INDELUZ	206
CONT.V5	CONTROLADORES	INDELUZ	205
CONT.WT1	CONTROLADORES	INDELUZ	207
CONT.WT5	CONTROLADORES	INDELUZ	208
D01A-823-01	NOK1	INDELUZ	216
D01B-823-01	NOK1	INDELUZ	216
D01B-823-02	NOK1	INDELUZ	216

REF.	FAM.	BRAND	PAG.
D01C-823-01	NOK1	INDELUZ	216
D01C-823-02	NOK1	INDELUZ	216
D01D-823-01	NOK1	INDELUZ	216
D01D-823-02	NOK1	INDELUZ	216
D01E-823-01	NOK1	INDELUZ	216
D01F-823-01	NOK1	INDELUZ	216
D01F-823-02	NOK1	INDELUZ	216
D01G-823-01	NOK1	INDELUZ	216
D01G-823-02	NOK1	INDELUZ	216
D01H-823-01	NOK1	INDELUZ	216
D01H-823-02	NOK1	INDELUZ	216
D02E-824-01	NOK2	INDELUZ	216
D02F-824-01	NOK2	INDELUZ	216
D02G-824-01	NOK2	INDELUZ	216
D02H-824-01	NOK2	INDELUZ	216
D02H-824-02	NOK2	INDELUZ	216
D03E-826-01	NOK3	INDELUZ	217
D03F-826-01	NOK3	INDELUZ	217
D03G-826-01	NOK3	INDELUZ	217
D03H-826-01	NOK3	INDELUZ	217
D03H-826-02	NOK3	INDELUZ	217
D04E-827-01	NOK4	INDELUZ	217
D04F-827-01	NOK4	INDELUZ	217
D04G-827-01	NOK4	INDELUZ	217
D04H-827-01	NOK4	INDELUZ	217
D04H-827-02	NOK4	INDELUZ	217
GRA_205CN	SENA	INDELUZ	192
GRA_207CN	SENA	INDELUZ	192
TAPSETIP65.SENA205CN	SENA	INDELUZ	192
TAPSETIP65.SENA207CN	SENA	INDELUZ	192
TAPSETIP65.SENARGB	SENA	INDELUZ	193



Graphic concept, layout and prepress by Novolux Lighting.

*NOVOLUX 002 02/2024*



