

# BIG WHITE<sup>®</sup>

SLV LIGHTING CATALOGUE 2024













## BEM INFORMADO

Digitalize o código QR, selecione o país e receba os nossos preços atualizados.  
Visite-nos em **slv.com**







# FAMÍLIAS QUE SE DESTACAM

NUMINOS® .....	82
NEW TRIA® .....	122
MEDO® .....	148
LALU® .....	176
ONE® .....	186

## INTERIOR

 Luminárias para encastrar .....	202
 Luminárias salientes para teto .....	248
 Luminárias suspensas .....	278
 Luminárias salientes para parede .....	320
 Luminárias para parede e teto .....	390
 Luminárias de mesa e de pé .....	434
 Sistema de 48 V .....	454
 Sistema de cabos de tensão reduzida .....	480
 Calha eletrificada de 1 circuito 230VAC (monofásica) .....	492
 Calha eletrificada de 3 circuitos 230VAC (trifásica) .....	524
 Soluções de perfil e tiras de LED .....	564

## EXTERIOR

 Luminárias móveis e luminárias de pé .....	594
 Projetores .....	686
 Luminárias salientes para parede .....	704
 Luminárias salientes para teto .....	786
 Luminárias salientes para parede e teto .....	802
 Luminárias de encastrar na parede e teto .....	818
 Luminárias para encastrar no pavimento .....	828

## ACESSÓRIOS

 Lâmpadas .....	858
 Componentes .....	866

## NAVEGAÇÃO

Editorial e referências .....	4
Índice de aplicações .....	14
Índice de famílias .....	46
Índice numérico .....	882
Índice alfabético .....	892

# NOVA NAVEGAÇÃO

## VISÃO GERAL DAS CATEGORIAS

Uma visão geral. Encontre a luminária correta com base na sua categoria.



## VISÃO GERAL DA FAMÍLIA

Descubra todas as luminárias de uma família para um design homogêneo.

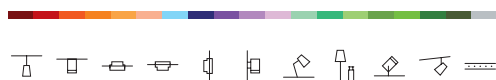

## CATEGORIAS DE PRODUTOS

Saiba a durabilidade. Os novos ícones e cores permitem uma navegação simples e rápida para as respectivas categorias de produtos.



## RECOMENDAÇÕES

Rápido e fácil. Descubra os acessórios e lâmpadas adequados aos produtos escolhidos por si.

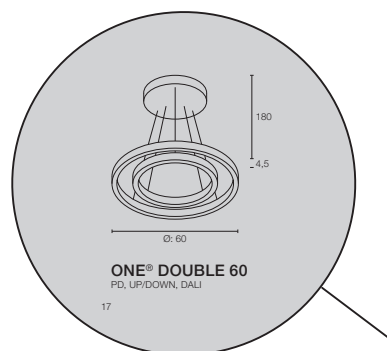

## ATENÇÃO

Todas as dimensões são indicadas em **cm**.

# EXPLICAÇÃO CLARA

Na nossa nova secção de conselhos, encontrará todas as informações importantes sobre o tema da luz e dos nossos produtos SLV explicadas de forma clara e concisa.

Desde guias de planeamento, representações dos sistemas e conhecimentos de iluminação, aprenderá tudo neste BIG WHITE®. Assim, esteja atento aos conselhos nas nossas páginas amarelas.

## CRIE O SEU PERFIL LED

Recomendamos-lhe uma nova instalação elétrica nos seus locais, com um comprimento a partir de 3 e 5 m

Dê o seu toque pessoal ou ilumine salas inteiras – Possibilidade de 700 a 4280 lm/m.

Adicione cor – Tiras de led nas versões: branco, regulação de brancos (tunable white) ou RGBW.

Difusores foscos, leitosos ou transparentes – Escolha entre difusores para uma maior personalização.

Para interiores, exteriores ou zonas de exterior – Equipado para todas as aplicações e IP54.

Quer seja perfil reduzido ou elevado ou de canto – Temos o perfil adequado para o seu projeto.

Comprimentos entre 5 m e 80 m, a proposta não conhece limites – a adaptação reduz totalmente a seu gosto. Tecnologia de 24V, abrange longas distâncias com menos pontos de alimentação.

Crie o seu perfil – Encontra uma visão geral das nossas tiras de LED flexíveis nas páginas 592–593. Para tal, apresentamos-lhe controladores adequados nas páginas de acessórios 866–881.

580



## TODOS OS ARTIGOS DISPONÍVEIS ONLINE

Em **slv.com** encontra a gama completa da SLV com todos os dados dos produtos, descrições, disponibilidade e muito mais. Ficheiros de planeamento úteis, 3D, configuradores e ferramentas de cálculo como o FastCalc by DIAL apoiam-no ao projetar a sua iluminação.

# VILLA WALDFEUCHT

## UMA CASA RECHEADA DE LUMINÁRIAS DA SLV

Um canal no Instagram que acompanha a aventura de construção da casa de um jovem casal.

Explicam diariamente no seu canal o motivo porque escolheram luminárias da SLV e os obstáculos que tiveram de ultrapassar.



### PLANEAMENTO CUIDADOSO DE ILUMINAÇÃO

Ao planear a iluminação, era importante para os dois proprietários estabelecer um estilo uniforme em toda a casa. Além disso, a iluminação deve adaptar-se permanentemente à utilização subsequente – por outras palavras, garantir a máxima flexibilidade.

As lâmpadas inteligentes GU10 devem adaptar-se às luminárias. Além disso, a Susanna e o Marc pretendiam uma mistura de iluminação direta e indireta que também colocasse a luz perfeita nas obras de arte. Por todos estes motivos, a Susanna e o Marc optaram pela calha eletrificada da SLV. Dificilmente algum tipo de iluminação oferece mais flexibilidade: com calhas, todas as luminárias podem ser trocadas, adicionadas ou alinhadas de forma diferente.

E no que toca a eficiência energética, isto também se repercute nas calhas eletrificadas. Com a iluminação indireta e o controlo inteligente, é possível poupar energia.



A Susanna e o Marc Mevißen têm partilhado os seus progressos com os seus seguidores desde a cerimónia de colocação da primeira pedra, em 2020, até à sua conclusão este ano.

É importante realçar o facto de, à exceção da estrutura da casa, terem feito tudo sozinhos. Apesar das obras na casa terem sido realizadas depois dos seus próprios trabalhos, prestaram especial atenção à construção sustentável, à eficiência energética e ao design sofisticado. Resultado: em apenas 22 meses, a casa já estava pronta para ser ocupada.

*«DESDE O INÍCIO QUE DECIDIMOS ESCOLHER A SLV E ISSO SIMPLIFICOU-NOS MUITO O PLANEAMENTO DA ILUMINAÇÃO.»*

Marc Mevißen, Arquiteto

### **SERVIÇO E QUALIDADE DA SLVS**

Há uma razão para Susanna e Marc escolherem as luminárias da SLV: Marc Mevißen já conhecia a SLV do curso de arquitetura, quando esteve envolvido na encenação com luz e sombra no showroom.

Ao planear a iluminação para a sua própria casa de sonho, os dois influenciadores ficaram particularmente impressionados com o design e a atraente relação preço/desempenho das calhas eletrificadas. Além disso, destacam o excelente apoio e o serviço rápido da SLV.





## LUZ COMO OBRA DE ARTE

A sala de jantar da casa de Susanna e do Marc tem um grande espaço vertical com 5,65 m de altura. Os dois quiseram criar uma espécie de escultura a partir de luminárias sobre a mesa de jantar. Como construção básica, as calhas eletrificadas foram integradas de forma invisível no teto acústico, de modo a manter a maior flexibilidade possível também aqui. Para encontrar ideias, a equipa da SLV trabalhou em conjunto com os proprietários da casa no local para obter inspiração e apresentou muitas luminárias novas. «Gostámos mais do PANTILO da SLV em termos de design e cor para preencher esteticamente o espaço aéreo sem ofuscar», explica Susanna Mevißen. «Gostamos muito deste reflexo nas luminárias e estas completam o nosso conceito.»

A luminária suspensa PANTILO impressiona com a sua aparência extraordinária: o abajur em vidro cromado pode ser facilmente combinado num elegante grupo de luminárias através da configuração individual. As sete luminárias PANTILO por cima da grande mesa de jantar combinam na perfeição com o teto alto de madeira, as paredes em tons claros, o chão cinzento e os caixilhos pretos das janelas da casa de Susanna e Marc.

*«AS LUMINÁRIAS NÃO SÃO APENAS FUNCIONAIS  
– TAMBÉM PODEM DAR A UMA DIVISÃO UMA  
IDENTIDADE COMO UMA OBRA DE ARTE.»*

Susanna Mevißen



## LUZ INDIRETA PARA UM AMBIENTE AGRADÁVEL

A casa não está apenas equipada com iluminação da SLV nos tetos: as luminárias estão também integradas no chão, onde as cores podem ser definidas individualmente. Os dois proprietários apostam na iluminação indireta e no controlo inteligente para todas as soluções de iluminação na sua casa de sonho: dependendo da intensidade da luz na divisão, algumas luminárias indiretas iluminam o ambiente/sala à noite e mergulham a casa no ambiente desejado. Assim quase nenhuma luz tem de ser ativamente ligada, o que poupa energia.



## CONSTRUÇÃO E ILUMINAÇÃO ECOLÓGICAS

Graças a um isolamento ponderado, a um telhado plano com um sistema fotovoltaico e a materiais selecionados como betão, madeira, vidro e pedra natural, a casa passiva dos dois influenciadores Susanna e Marc cumpre a norma KfW40+ e é um edifício energia plus. Com o sistema fotovoltaico, produzem muito mais energia do que a que consomem. A casa dispõe ainda de um sistema de armazenamento de energia e de uma wallbox para utilizar a eletricidade de forma ainda mais eficaz.

Esta abordagem também se enquadra na nossa estratégia de sustentabilidade: porque também tentamos confiar na utilização de matérias-primas secundárias na produção de soluções de luz e iluminação, e reduzimos consistentemente os resíduos de embalagens e as emissões de transporte.

### PROJETO FORTE. PARCEIRO FORTE

Proprietários: Susanna e Marc Mevißen

Local: Waldfeucht, Alemanha  
E-mail: [mevissen.haus@gmail.com](mailto:mevissen.haus@gmail.com)

Lighting design: os proprietários em cooperação com o serviço externo da SLV

A iluminação para a villa em Waldfeucht não é a única colaboração que os nossos especialistas apoiaram ativamente. Temos parceiros em toda a Europa com projetos de todos os tamanhos. Quer saber mais? Faça uma leitura deste QR code!

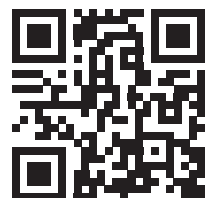

# CONCEITOS SLV

---

## LÚMEN

O fluxo luminoso ou luminância (expresso em lúmenes) descreve a quantidade de luz emitida por uma fonte de luz em todas as direções. É considerada a luminosidade total percebida pelo olho humano. A eficiência de uma luminária também é frequentemente indicada em lúmenes por watt. Quanto maior for o fluxo luminoso emitido (em lúmens) por potência utilizada (em watts), mais eficiente é a fonte de luz.

## IRC

O índice de reprodução cromática é o efeito de uma fonte de luz na impressão de cor que uma pessoa tem de um objeto, em comparação com uma fonte de luz natural (por exemplo, a luz solar). De acordo com a norma EN 12464-1, os espaços interiores onde as pessoas passam muito tempo ou trabalham devem ter um índice de reprodução cromática (IRC) >80.

## TEMPERATURA DE COR

A temperatura de cor de uma fonte de luz é expressa em K (Kelvin). Quanto mais elevada for a temperatura de cor, mais fria e ativadora será a luz (por exemplo: luz do dia = 5500K). Quanto mais baixo for o número Kelvin, mais quente e relaxante é a luz. A temperatura de cor da lâmpada de 2700 K é hoje recomendada como a luz perfeita para a habitação. A temperatura de cor de uma luminária pode ser selecionada através do interruptor CCT.

## DIM-TO-WARM (DTW)

Com a função Dim-to-Warm é possível regular a temperatura de cor com a intensidade de luz das luminárias. Assim, ao reduzir a quantidade de luz emitida, esta passa de uma luz brilhante e fria para uma luz suave e quente.

## TUNEABLE WHITE (TW)

A função Tuneable White permite ajustar separadamente a quantidade de luz e a temperatura da cor das luminárias LED. A luz pode ser ajustada para estar de acordo com diferentes ambientes e diferentes alturas do dia.

## RGB RGB+W

Uma luminária com capacidade RGB pode cobrir todo o espectro de cores a partir das cores vermelho, verde e azul, passando o branco para segundo plano. Com o complemento de RGB+W, a luz branca é também otimizada e representada com alta qualidade.

## CLASSE DE PROTEÇÃO

Os índices de proteção indicam as medidas de segurança que um dispositivo possui para evitar choques elétricos. Há três classes de proteção, cada uma representada pelos símbolos abaixo.



## IK

O índice de proteção IK é uma classificação de materiais de construção e superfícies que determina a sua resistência a efeitos mecânicos, como impactos, choques ou pressão.

## IP

A abreviatura IP significa Ingress Protection (grau de proteção). O código IP padronizado, por exemplo, usa o primeiro dígito para indicar proteção contra corpos estranhos e contacto, enquanto o segundo descreve a impermeabilidade à água e à humidade.

## ÂNGULO DE MEIA DISPERSÃO

O ângulo de meia dispersão ou ângulo de abertura, descreve a emissão de luz tendo em consideração a estrutura da luminária, fonte de luz e a distância a um objeto. Quanto mais pequeno o ângulo de meia dispersão, mais estreito o feixe de luz.

## UGR

UGR (Unified Glare Rating) classifica o encadeamento causado pelas luminárias de modo a aliviar a visão. Quanto mais baixo o UGR, mais agradável é a luz para os olhos. Por conseguinte, recomenda-se um UGR<19 para os locais de trabalho.

## SMART LIGHTING

Smart Lighting é o termo utilizado para descrever o controlo automatizado da iluminação. Com DALI, ZIGBEE, Casambi e BLUETOOTH, as luminárias inteligentes podem ser controladas através de aplicações (apps) ou outros elementos de controlo.

LALU®  
1007519+1007522



LALU®  
1007520+1007532





Encontre a família **NUMINOS®** nas páginas 82-93

LED

NEW



Encontre a família **NEW TRIA®** nas páginas 122-147

LED



Encontre a família **MEDO®** nas páginas 168-171

LED

NEW



LED

UNIVERSAL DOWNLIGHT | 205

NEW



LED

UNIVERSAL DOWNLIGHT | 207

NEW



LED

UNIVERSAL DOWNLIGHT | 208

NEW



LED

UNIVERSAL DOWNLIGHT | 209

NEW



LED

KADUX | 213

NEW



LED

KADUX | 213

NEW



LED

KADUX | 213



SCKET

KADUX | 214



SCKET

KADUX | 214



SCKET

KADUX | 214



SCKET

KADUX | 215



SCKET

KADUX | 215



LED

MILANDOS 4 | 217



LED

MILANDOS 6 | 217



LED

MILANDOS 8 | 217



LED

HORN MINI | 218



SCKET

HORN | 219



SCKET

HORN | 219



SCKET

HORN | 219



SCKET

HORN | 220



SCKET

HORN | 220



SCKET

HORN | 220



SCKET

HORN-T | 221



LED

HORN MAGNA | 221



LED

SENER 12 | 223



LED

SENER 18 | 223



LED

SENER 24 | 223



LED

SENER 12 | 225



LED

SENER 18 | 225



LED

SENER 24 | 225



LED

VERLUX | 227



LED

VERLUX | 227



LED

DL 126 | 227



SCKET

PIKA | 228



SCKET

PIKA | 228



LED

OCULUS | 229



**LED**  
OCCULDAS 14 | 230



**LED**  
OCCULDAS 23 | 230



**LED**  
CONTONE® | 231



**LED**  
CONTONE® | 231



**LED**  
H-LIGHT | 232



**LED**  
KARPO 30 | 232



**SCKET**  
PLASTRA | 233



**SCKET**  
PLASTRA | 233



**LED**  
DEKLED | 234



**SCKET**  
VARU | 234



**SCKET**  
DOLIX OUT | 235



**SCKET**  
DOLIX OUT | 235



**LED**  
KAMUELA ECO | 236



**LED**  
KAMUELA ECO | 237



**LED**  
KINI | 237



**LED**  
AKALO D83 | 237



**LED**  
FRAME BASIC SET | 238



**LED**  
FRAME BASIC | 238



**LED**  
FRAME BASIC | 238



**LED**  
FRAME CURVE | 239



**LED**  
FRAME CURVE | 239



**LED**  
QUAD FRAME 9 | 240



**LED**  
NOTAPO S | 241



**LED**  
NOTAPO L | 241



**LED**  
DOWNUNDER PUR 80 | 242



**LED**  
DOWNUNDER PUR 150 | 242



**LED**  
MOBALA | 243



**LED**  
WORO | 243



**LED**  
LED PANEL | 243



**LED**  
PATTA-I | 244



**LED**  
PATTA-I | 244



**LED**  
PATTA-I | 245



**LED**  
PATTA-I | 245



**LED**  
PATTA-F | 246



**LED**  
PATTA-F | 247

INTERIOR | LUMINÁRIAS PARA ENCASTRAR NA PAREDE



EXTERIOR | LUMINÁRIAS PARA ENCASTRAR NO PAVIMENTO

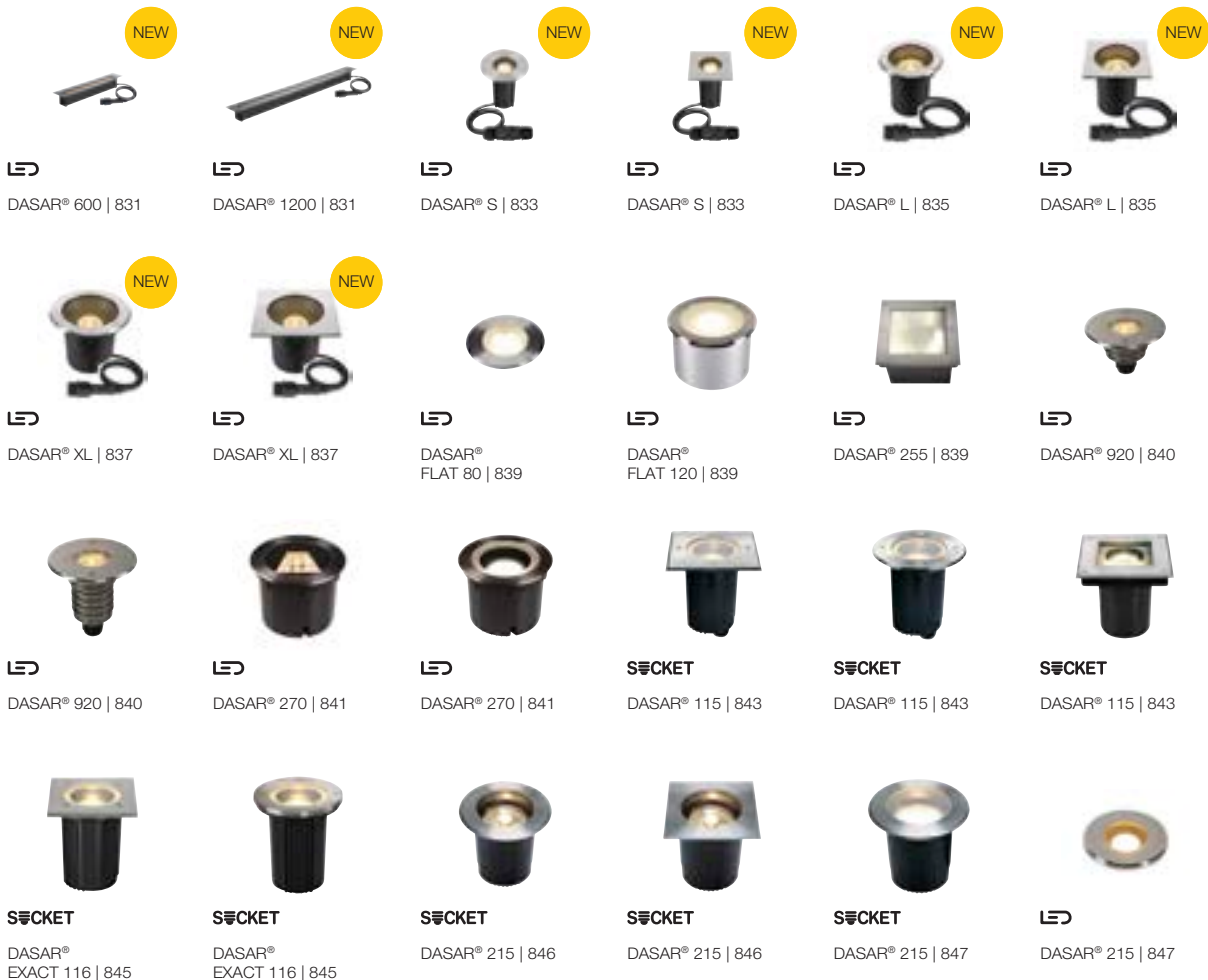







Encontre a família NUMINOS® nas páginas 102-105

LED



Encontre a família MEDO® nas páginas 164-165

LED



SCKET

VARYT | 251



LED

Q-LINE® | 253



LED

Q-LINE® | 253



SCKET

TRILEDO | 255



SCKET

TRILEDO | 255



SCKET

TRILEDO | 255



LED

TRILEDO | 257



LED

TRILEDO | 257



LED

TRILEDO | 257



LED

OCULUS | 258



SCKET

ENOLA B | 259



LED

ENOLA C | 259



SCKET

ASTINA | 261



SCKET

NAGY 75 | 261



LED

ANELA | 261



LED

OCCLUDAS 13 | 262



LED

OCCLUDAS 23 | 262



SCKET

ALTRA DICE | 263



SCKET

ALTRA DICE | 263



SCKET

KARDAMOD | 265



SCKET

KARDAMOD | 265



SCKET

FENDA | 266



FENDA | 267



FENDA | 267



FENDA | 267



SCKET

TENORA | 268



SCKET

SOPRANA | 269



SCKET

PLASTRA | 270



LED

PLASTRA | 271



SCKET

PLASTRA 105 | 271



SCKET

PLASTRA 104 | 271



LED

FERA 25 | 272



LED

FERA 25 | 272



LED

MARONA | 273



LED

PANEL 60 | 274



LED

PANEL | 275



LED

PANEL 60 | 275



LED

PANEL | 275



EXTERIOR | LUMINÁRIAS SALIENTES PARA TETO



**SCKET**  
PHOTONI | 789



**LED**  
S-CUBE | 791



**LED**  
ESKINA FRAME | 791



**LED**  
ENOLA OCULUS | 792



**LED**  
ENOLA ROUND S | 793



**LED**  
ENOLA ROUND M | 793



**LED**  
ENOLA ROUND L | 793



**LED**  
ENOLA SQUARE S | 795



**LED**  
ENOLA SQUARE M | 795



**LED**  
ENOLA SQUARE L | 795



**LED**  
BIG THEO | 797



**SCKET**  
BIG THEO | 797



**LED**  
OVALISK | 797



**SCKET**  
PHOTONIA | 799



**SCKET**  
MOLAT | 799



**SCKET**  
SITRA | 801



**SCKET**  
ROX | 801



**SCKET**  
ROX | 801





Encontre a família **NUMINOS®** nas páginas 106–109

LED



Encontre a família **MEDO®** nas páginas 166–167

LED



**NEW**

Encontre a família **LALU®** nas páginas 176–185

LED



Encontre a família **ONE®** nas páginas 186–191

LED



**SCKET**  
PANTILO ROPE 19 | 279



**SCKET**  
PANTILO ROPE 20 | 279



**SCKET**  
PANTILO ROPE 27 | 279



**SCKET**  
PANTILO OVAL | 281



**SCKET**  
PANTILO 20 | 281



**SCKET**  
PANTILO 28 | 281



**SCKET**  
PANTILO CONVEX 29 | 283



**SCKET**  
PANTILO CONVEX 40 | 283



**SCKET**  
ASTO TUBE | 285



**SCKET**  
ASTO TUBE | 285



**SCKET**  
ASTO TUBE | 285



**SCKET**  
ASTO TUBE | 285



LED  
WORKLIGHT PRO 120 | 287



LED  
WORKLIGHT PRO 150 | 287



LED  
WORKLIGHT | 288



LED  
I-PENDANT PRO | 289



LED  
PANEL 60 | 289



LED  
NOYA | 290



LED  
GLENOS® | 291



LED  
GLENOS® | 291



LED  
Q-LINE® | 293



LED  
Q-LINE® | 293



LED  
Q-LINE® | 293



LED  
OCULUS | 294



**SCKET**  
FITU | 295



**SCKET**  
FENDA | 296



FENDA | 296



FENDA | 296



FENDA | 297



FENDA | 297



FENDA | 297



LED

HELIA  
AMBIENT 35 | 300



LED

HELIA  
AMBIENT 35 | 300



LED

HELIA 30 | 301



LED

HELIA 30 | 301



LED

HELIA 40 | 303



LED

HELIA 40 | 303



SCKET

ASTINA | 305



SCKET

ENOLA B | 305



SCKET

ENOLA | 305



LED

ANELA | 306



SCKET

LISENNE | 306



SCKET

TONGA® | 307



SCKET

QUADRASS | 307



SCKET

PARA CONE GL | 309



SCKET

PARA CONE 20 | 309



SCKET

PARA CONE 30 | 309



SCKET

PHELIA 10 | 310



SCKET

PHELIA 20 | 311



SCKET

PHELIA 25 | 311



SCKET

PHELIA 30 | 311



SCKET

FORCHINI 50 | 312



SCKET

FORCHINI 70 | 312



SCKET

FORCHINI M 40 | 313



SCKET

FORCHINI M 50 | 313



SCKET

LIGHT EYE® 90 | 314



SCKET

LIGHT EYE® 150 | 314



SCKET

SUN / BIG SUN | 315



SCKET

ROTOBALL 25 | 317



SCKET

ROTOBALL 40 | 317



SCKET

ROTOBALL 50 | 317



SCKET

PARA DOME | 318



PARA DOME | 318



PARA DOME | 318



SCKET

PARA 380 | 319



LED  
LYGANT | 325



LED  
LYGANT | 325



SCKET  
VARYT | 327



LED  
SEDO 7 | 329



LED  
SEDO 14 | 329



LED  
SEDO 21 | 329



LED  
TRUKKO | 330



LED  
TRUKKO | 330



LED  
TRUKKO | 331



LED  
TRUKKO 80 | 331

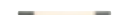

LED  
TRUKKO 60 | 332



LED  
TRUKKO 90 | 332



LED  
MARYLIN 40 | 333



LED  
WL 149 | 334



SCKET  
WL 149 | 334



SCKET  
WL 106 | 335



SCKET  
WL 106 | 335



SCKET  
MIBO UP/DOWN | 337



LED  
MAGANDA | 337



LED  
DORISA 30 | 339



LED  
DORISA 50 | 339



LED  
GLENOS® 60 | 339



LED  
L-LINE 60 | 341



LED  
L-LINE 120 | 341



LED  
Q-LINE® | 341



SCKET  
PANTILO ROPE | 345



SCKET  
ASTO TUBE | 347



SCKET  
ASTO TUBE | 347



LED  
MANA BASE | 349



LED  
MANA BASE | 349



LED  
MANA 40 | 319



LED  
MANA 60 | 349



LED  
MANA | 351



LED  
MANA | 351



LED  
MANA | 351



LED  
MANA | 353



LED  
MANA | 353



LED  
MANA | 353



LED  
MANA | 353



LED  
OCULUS | 355



LED  
OCULUS  
UP/DOWN | 355



SCKET  
PLASTRA | 356



**SCKET**  
PLASTRA | 356



**SCKET**  
PLASTRA | 357



**SCKET**  
PLASTRA | 357



**SCKET**  
PLASTRA | 359



**LED**  
PLASTRA | 359



**LED**  
PLASTRA | 359



**SCKET**  
PLASTRA | 360



**SCKET**  
PLASTRA 101 | 361



**SCKET**  
PLASTRA | 361



**SCKET**  
PLASTRA 104 | 361



**LED**  
LOGS IN | 362



**LED**  
LOGS IN | 362



**LED**  
LOGS IN L | 363



**LED**  
LOGS IN L | 363



**LED**  
QUAD FRAME 14 | 364



**LED**  
QUAD FRAME 19 | 364



**LED**  
SHELL 15 | 365



**LED**  
SHELL 30 | 365



**LED**  
ASSO 300 | 366



**LED**  
ASSO 300 | 367



**SCKET**  
OSSA 180 | 367



**SCKET**  
OSSA 300 | 367



**LED**  
CARISO | 368



**LED**  
CARISO | 368



**LED**  
CHROMBO | 369



**LED**  
DIRETO 60 | 370



**LED**  
DIRETO 90 | 370



**LED**  
ARLINA 60 | 371



**LED**  
ARLINA 130 | 371



**SCKET**  
ANDREAS | 373



**SCKET**  
DENA 30 | 373



**SCKET**  
BASKET | 373



**SCKET**  
QUADRASS | 375



**LED**  
QUADRASS  
SPOT | 375



**SCKET**  
LISENNE | 375



**SCKET**  
FITU | 376



**SCKET**  
FITU CUBE | 376



**SCKET**  
THEO UP/DOWN | 377



**SCKET**  
SOLID CUBE | 377



**ENOLA B** | 379



**ENOLA B** | 379



**ASTINA  
UP/DOWN** | 379



**S**CKET

FENDA | 380



FENDA | 380



**LED**

KENKUA SPOT | 381



**LED**

COUPA FLEX | 381



**LED**

KARPO MAGN | 382



**LED**

KARPO GOOSE | 382



**LED**

KARPO 30 | 383



**LED**

KARPO | 383



**LED**

SOMNILA SPOT | 384



**LED**

SOMNILA SPOT | 385



**LED**

SOMNILA FLEX | 385



**LED**

SOMNILA FLEX | 385



**S**CKET

DIO FLEX PLATE | 387



**LED**

DIO FLEX PLATE | 387



**LED**

DIO FLEX PLATE | 387



**S**CKET

PHELIA | 388



**LED**

MERADO FLOOD | 388



**S**CKET

DISPLAY ADL 50 | 389





EXTERIOR | LUMINÁRIAS DE PAREDE



NEW

**SCKET**  
PHOTONI | 709



NEW

**LED**  
LID II | 711



NEW

**LED**  
LID II | 711



NEW

**LED**  
LID I | 713



NEW

**LED**  
LID I | 713



NEW

**LED**  
I-RING | 714



NEW

**LED**  
OVAL 14 | 715



NEW

**LED**  
OVAL 18 | 715



NEW

**LED**  
CONCRETO M | 717



NEW

**LED**  
CONCRETO L | 717



**LED**  
VANO WING | 719



**LED**  
VANO WING | 719



**LED**  
MANA BASE | 720



NEW

**RUSTY®**  
MANA | 720



NEW

**RUSTY®**  
MANA | 720



**LED**  
MANA OUT | 721



NEW

**LED**  
MANA OUT | 721



NEW

**LED**  
ENOLA OCULUS | 723



NEW

**LED**  
ENOLA  
OCULUS | 723



**LED**  
ENOLA  
OCULUS S | 725



**LED**  
ENOLA  
OCULUS M | 725



**LED**  
ENOLA  
ROUND L | 725



**LED**  
ENOLA ROUND S  
UP/DOWN | 727



**LED**  
ENOLA ROUND M  
UP/DOWN | 727



**LED**  
ENOLA ROUND L  
UP/DOWN | 727



**LED**  
ENOLA  
SQUARE S | 729



**LED**  
ENOLA  
SQUARE M | 729



**LED**  
ENOLA  
SQUARE L | 729



**LED**  
ENOLA SQUARE S  
UP/DOWN | 730



**LED**  
ENOLA SQUARE M  
UP/DOWN | 730



**LED**  
ENOLA SQUARE L  
UP/DOWN | 730



**SCKET**  
THEO UP/DOWN | 735



**LED**  
BIG THEO BEAM UP/  
FLOOD DOWN | 735



**SCKET**  
BIG THEO  
UP/DOWN | 735



**LED**  
BIG THEO FLOOD  
UP/DOWN | 736



**SCKET**  
THEO | 736



**SCKET**  
BIG THEO | 737



**LED**  
BIG THEO | 737



**LED**  
SITRA S | 739



**LED**  
SITRA S | 739



**LED**  
SITRA M | 741



**LED**  
SITRA L | 741

NEW



**SCKET**  
SITRA CUBE | 741



**SCKET**  
GRAFIT | 742



**SCKET**  
GRAFIT | 742



**SCKET**  
GRAFIT | 743



**SCKET**  
GRAFIT | 743



**LED**  
QUADRULO | 744



**SCKET**  
QUADRULO  
SENSOR | 745



**SCKET**  
QUADRULO | 745



**SCKET**  
MERIDIAN | 746



**SCKET**  
MERIDIAN BOX | 746



**SCKET**  
MERIDIAN BOX  
SENSOR | 747



**SCKET**  
MERIDIAN BOX | 747



**LED**  
ESKINA FRAME | 749



**LED**  
ESKINA FRAME | 749



**LED**  
ESKINA FRAME | 749



**LED**  
BOOKAT | 751



**LED**  
BIG QUAD | 752



**LED**  
QUAD | 752



**LED**  
QUAD  
UP/DOWN 15 | 753



**LED**  
BIG QUAD  
UP/DOWN | 755



**LED**  
BIG QUAD | 755



**LED**  
RUSTY®  
UP/DOWN | 756



**LED**  
RUSTY®  
UP/DOWN | 756



**LED**  
OVALISK  
SENSOR | 757



**LED**  
OVALISK | 757



**LED**  
PEMA® | 758



**LED**  
PEMA® | 759



**LED**  
PEMA® | 759



**SCKET**  
PEMA® | 759



**LED**  
FLATT SENSOR | 760



**LED**  
FLATT | 760



**SCKET**  
ASTINA | 761



**SCKET**  
ASTINA STEEL | 761



**LED**  
ANGOLUX  
SENSOR | 762



**LED**  
ANGOLUX | 762



**LED**  
VILUA S | 763



**LED**  
VILUA L | 763



**LED**  
VILUA | 763



**SCKET**  
MYRA  
UP/DOWN | 764



**LED**  
SITRA  
UP/DOWN | 765



**SCKET**  
SITRA  
UP/DOWN | 765



**SCKET**  
ROX | 767



**SCKET**  
ROX UP/DOWN | 767



**LED**  
DELWA | 767



**LED**  
SLOTS | 768



**SCKET**  
WALLYX | 768



**LED**  
DOWNUNDER  
OUT | 769



**LED**  
DOWNUNDER  
OUT | 769



**LED**  
ABRIDOR  
SENSOR | 770



**LED**  
ABRIDOR | 770



**LED**  
ORDI SENSOR | 771



**LED**  
ORDI | 771



**SCKET**  
BOX-L | 773



**LED**  
BOX-L | 773



**SCKET**  
BOX UP/DOWN | 775



**LED**  
LOGS | 775



**LED**  
OUT-BEAM UP /  
FLOOD DOWN | 775



**LED**  
L-LINE OUT | 775



**SCKET**  
PHOTONIA | 777



**SCKET**  
MOLAT | 777



**SCKET**  
GLOO PURE | 777



**SCKET**  
F-POL | 778



**SCKET**  
SQUARE | 779



**SCKET**  
KERAS ELT | 779



**SCKET**  
SITRA | 779



**LED**  
RASCALI | 780



**LED**  
IPERI | 780



**SCKET**  
QUADRASYL | 781



**SCKET**  
SQUARE TURN | 781



**LED**  
TODAY PRO | 783



**LED**  
ESKINA D | 783



**SCKET**  
MYRA DISPLAY | 783



**LED**  
LED SPOT | 785



**SCKET**  
NAUTILUS | 785



**SCKET**  
MYRA | 785



Encontre a família **NUMINOS®** nas páginas 98-101

LED



NEW

Encontre a família **MEDO®** nas páginas 148-163

LED



Encontre a família **ONE®** nas páginas 192-193

LED



NEW

**SCKET**  
PANTILO  
ROPE 19 | 393



NEW

**SCKET**  
PANTILO  
ROPE 27 | 393



NEW

LED  
CYFT | 395



NEW

**SCKET**  
ASTO TUBE | 395



NEW

**SCKET**  
ASTO TUBE | 397



**SCKET**  
ASTO TUBE | 397



**SCKET**  
ASTO TUBE | 399



**SCKET**  
ASTO TUBE | 397



LED  
OCULUS | 399



LED  
KARPO 30 | 399



LED  
NOBLO® | 401



LED  
NOBLO® | 401



LED  
NOBLO® | 401



LED  
KALU | 403



LED  
KALU | 403



LED  
KALU | 403



LED  
KALU | 403



**SCKET**  
KALU | 405



**SCKET**  
KALU | 405



**SCKET**  
KALU | 405



**SCKET**  
KALU | 405



**SCKET**  
ENOLA B | 407



**SCKET**  
ENOLA B | 407



**SCKET**  
ENOLA B | 407



**SCKET**  
ALTRA DICE | 408



**SCKET**  
SPOT 79 | 409



**SCKET**  
INDA | 409



**SCKET**  
PURI | 411



**SCKET**  
PURI | 411



**SCKET**  
PURI | 411



**SCKET**  
PURI | 411



**SCKET**  
AVO | 413



**SCKET**  
AVO | 413



**SCKET**  
AVO | 413



**SCKET**  
AVO | 413



**SCKET**  
AVO | 415



**SCKET**  
ASTO | 415



**SCKET**  
ASTO | 415



**SCKET**  
ASTO | 415



**LED**  
SENSER  
12, 18, 24 | 417



**LED**  
SENSER  
12, 18, 24 | 419



**LED**  
SIMA | 420

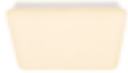

**LED**  
SIMA | 421



**LED**  
LIPSY®  
30, 40, 50 | 423



**LED**  
LIPSY®  
30, 40, 50 | 425-426



**SCKET**  
MELAN | 427



**SCKET**  
GLASSA | 427



**LED**  
BATTEN 60 | 429



**LED**  
BATTEN 120 | 429



**LED**  
LONG GRILL | 430



**LED**  
SIGHT 60 | 431



**LED**  
SIGHT 115 | 431



**LED**  
BENA 120 | 433



**LED**  
BENA 150 | 433

EXTERIOR | LUMINÁRIAS PARA PAREDE E TETO

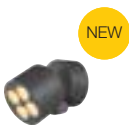

**LED**  
R-CUBE | 805



**LED**  
S-CUBE | 805



**SCKET**  
S-TUBE | 805



**LED**  
ESKINA SPOT/  
SENSOR | 807



**SCKET**  
SITRA 360 | 808



**SCKET**  
THEO BRACKET | 808



**LED**  
HELIA | 809



**LED**  
HELIA | 809



**SCKET**  
MYRA | 811



**LED**  
OUT-BEAM  
FRAME | 811



**LED**  
QUADRULO | 811



**LED**  
AINOS | 812-813



**LED**  
AINOS | 813



**LED**  
RUBA | 814



**SCKET**  
BULAN | 815



**SCKET**  
BULAN GRID | 815



**LED**  
TERANG 200 | 817



**LED**  
IMPERVA | 817

VINOLINA TWO  
1007696

---





INTERIOR | LUMINÁRIAS DE MESA E DE PÉ



**NEW**

**Encontre a família ONE® nas páginas 196-197**

**LED**



**NEW**

**LED**

VINOLINA ONE | 437



**NEW**

**LED**

VINOLINA | 437



**NEW**

VINOLINA TWO | 439



**NEW**

TAHA | 441



**NEW**

**SCKET**

TINY SUN | 443



**NEW**

**SCKET**

LITTLE SUN | 443



**NEW**

**SCKET**

VARYT | 443



**NEW**

**LED**

WORKLIGHT PRO | 444



**NEW**

**LED**

WORKLIGHT PRO | 444



**LED**

WORKLIGHT | 445



**LED**

WORKLIGHT | 445



**SCKET**

FENDA | 447



**SCKET**

FENDA | 447



**SCKET**

FENDA | 447



**SCKET**

FENDA | 448



**SCKET**

FENDA BOW BASIS | 448



FENDA | 448



FENDA | 449



FENDA | 449



FENDA | 449



**LED**

KARPO | 452



**LED**

KARPO | 452



**SCKET**

PHELIA | 453



**LED**

TONILA | 453



**LED**

MAGANDA | 453



NEW

LED  
VINOLINA ONE | 597



NEW

LED  
VINOLINA | 597



NEW

LED  
VINOLINA TWO | 599



LED  
TONILA | 601



NEW

LED  
TAHA | 601



NEW

SCKET  
S-TUBE 32/75 | 603



NEW

SCKET  
PHOTONI 45/75 | 605



NEW

LED  
S-CUBE 35/75 | 607



NEW

LED  
R-CUBE 35/70 | 609



NEW

LED  
LID I 75 | 611

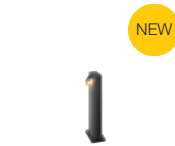

NEW

LED  
LID I 45 | 611



NEW

LED  
I-RING | 613



NEW

LED  
M-POL S | 614



NEW

LED  
M-POL S | 615



LED  
M-POL S | 616



LED  
M-POL S | 617



LED  
M-POL S | 618



LED  
M-POL M | 619



LED  
M-POL M | 620



LED  
M-POL M | 621



M-POL 30/60/90 | 623



SCKET  
CONCRETO | 627



SCKET  
CONCRETO | 627



LED  
ESKINA  
FRAME 45/75 | 629



LED  
ESKINA  
FRAME 75 | 629



LED  
ESKINA FRAME  
125/175 | 630



LED  
ESKINA 30/80 | 631



LED  
LOGS 40/70 | 633



SCKET  
GRAFIT 30/60/90 | 635



SCKET  
GRAFIT 30/60/90 | 637



LED  
QUADRULO | 639



LED  
RUSTY®  
SLOT 50/80 | 640



SCKET  
RUSTY®  
SLOT 50/80 | 641



SCKET  
RUSTY®  
PATHLIGHT | 642



LED  
RUSTY® 40/70 | 643



SCKET  
RUSTY® 40/70 | 643



SCKET  
RUSTY®  
CONE 24 | 645



SCKET  
RUSTY®  
CONE 40/70 | 645



SCKET  
RUSTY® 40/70 | 646



SCKET  
ARROCK  
GRANITE 40/70 | 647



SCKET  
ARROCK  
ARC | 648



LED  
ARROCK  
STONE 50/75 | 649





**SCKET**  
ARROCK SLOT | 649



**LED**  
L-LINE OUT 30 | 650



**LED**  
L-LINE OUT 60 | 651



**LED**  
L-LINE OUT 50/80 | 651



**SCKET**  
THEO PATHLIGHT | 652



**LED**  
OVALISK 75/100 | 653



**SCKET**  
GLOO PURE 27/44/70 | 655



**SCKET**  
ROTOBALL 25/40/50 | 657



**SCKET**  
PHOTONIA | 659



**SCKET**  
PHOTONIA | 659



**SCKET**  
OTOS GLAS | 659



**SCKET**  
CUBIX | 660



**SCKET**  
CONE | 660



**SCKET**  
MOLAT | 661



**SCKET**  
MOLAT | 661



**SCKET**  
LISENNE 40/70 | 662



**SCKET**  
ADEGAN MANILA | 663



**SCKET**  
ADEGAN | 663



**SCKET**  
ALPA MUSHROOM 45/75 | 665



**SCKET**  
ALPA CONE 100 | 665



**LED**  
APONI 90/120 | 666



**LED**  
TRUST 30/60 | 667



**SCKET**  
BIG NAILS 50/80 | 668



**SCKET**  
ROX ACRYL 30/60/90 | 669



**SCKET**  
VAP SLIM 30/60/90 | 671



**SCKET**  
C-POL | 672



**SCKET**  
F-POL | 672



**SCKET**  
SQUARE POLE 30/60/90 | 673



**LED**  
SLOTS 45/65 | 675



**LED**  
H-POL 30/60 | 676



**LED**  
H-POL TWIN 30/60 | 677



**LED**  
SLOTBOX 40/70 | 678



**LED**  
FLATT 65/100 | 679



**LED**  
ABRIDOR 60/100 | 681



**LED**  
IPERI 50 | 681



**SCKET**  
QUADRASYL 75 | 682



**LED**  
QUAD POLE | 683



**LED**  
BOOKAT | 683



**LED**  
RASCALI 45/65 | 684



**SCKET**  
MYRA SPOT | 685



**SCKET**  
SITRA 360 | 685

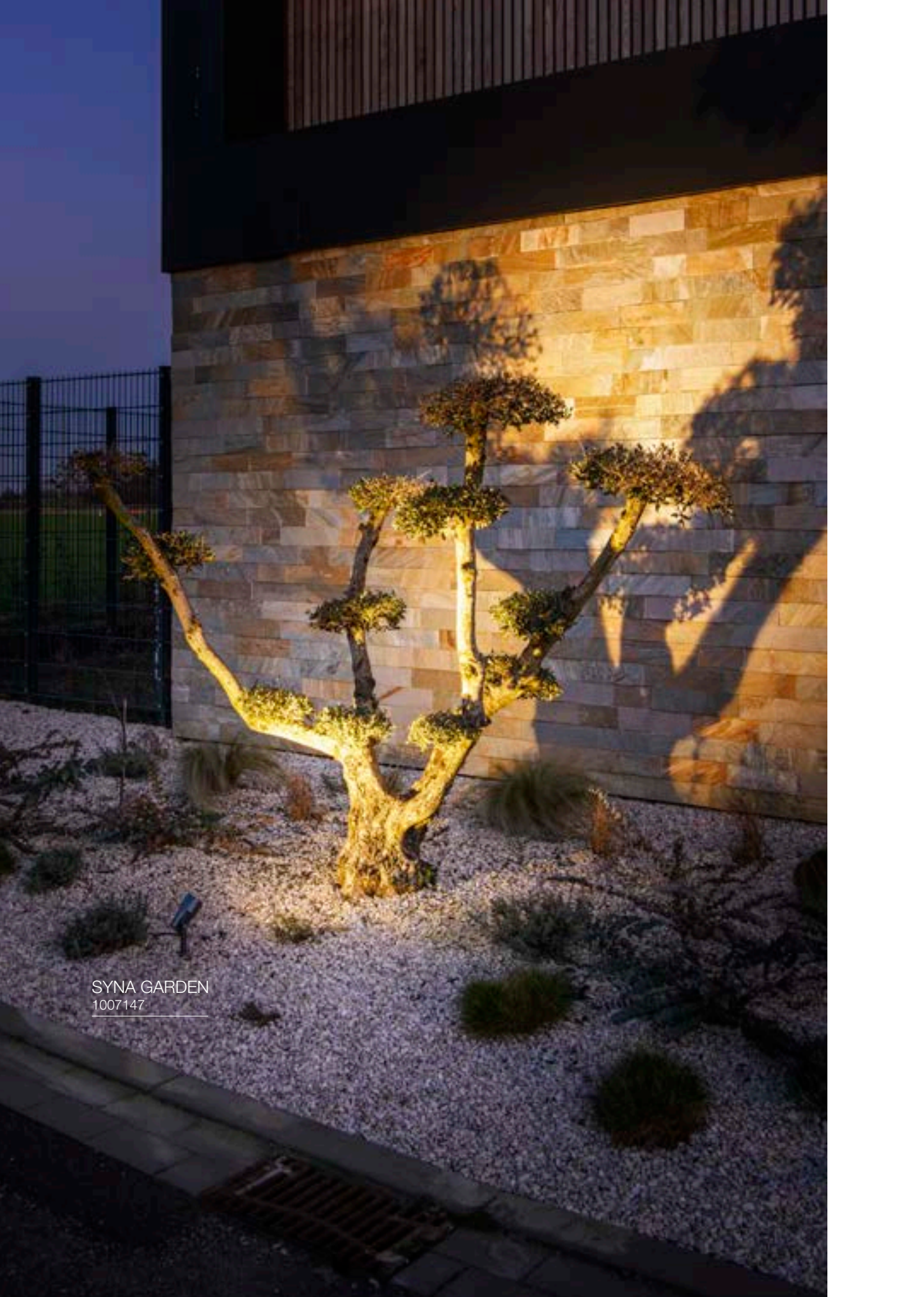

SYNA GARDEN  
1007147



EXTERIOR | PROJETORES



**LED**  
SYNA PLANT | 689



**LED**  
SYNA GARDEN | 689



**LED**  
SYNA | 689



**LED**  
FLOODI S | 691



**LED**  
FLOODI M | 691



**LED**  
FLOODI L | 691



**LED**  
GALEN 60 | 692



**LED**  
GALEN 120 | 692



**LED**  
FLAC BEAM® | 693



**SCKET**  
SAMRINA | 693



**SCKET**  
NAUTILUS 10 | 694



**SCKET**  
BIG NAUTILUS | 694



**SCKET**  
NAUTILUS 10 | 695



**LED**  
NAUTILUS 10 | 696



**SCKET**  
NAUTILUS | 697



**SCKET**  
NAUTILUS 10  
SPOT | 697



**LED**  
NAUTILUS 10  
SPOT LED | 697



**LED**  
DASAR®  
PROJECTOR | 698



**LED**  
DASAR® 920 | 698



**LED**  
HELIA SPOT S | 699



**LED**  
HELIA SPOT L | 699



**SCKET**  
THEO BRACKET | 701



**LED**  
LED SPIKE | 701



**SCKET**  
SITRA 360 SPIKE | 703



**SCKET**  
SITRA 360 SPIKE | 703

IN-LINE 44  
1006621

NUMINOS® XS  
1006762

NUMINOS® XS  
1006654

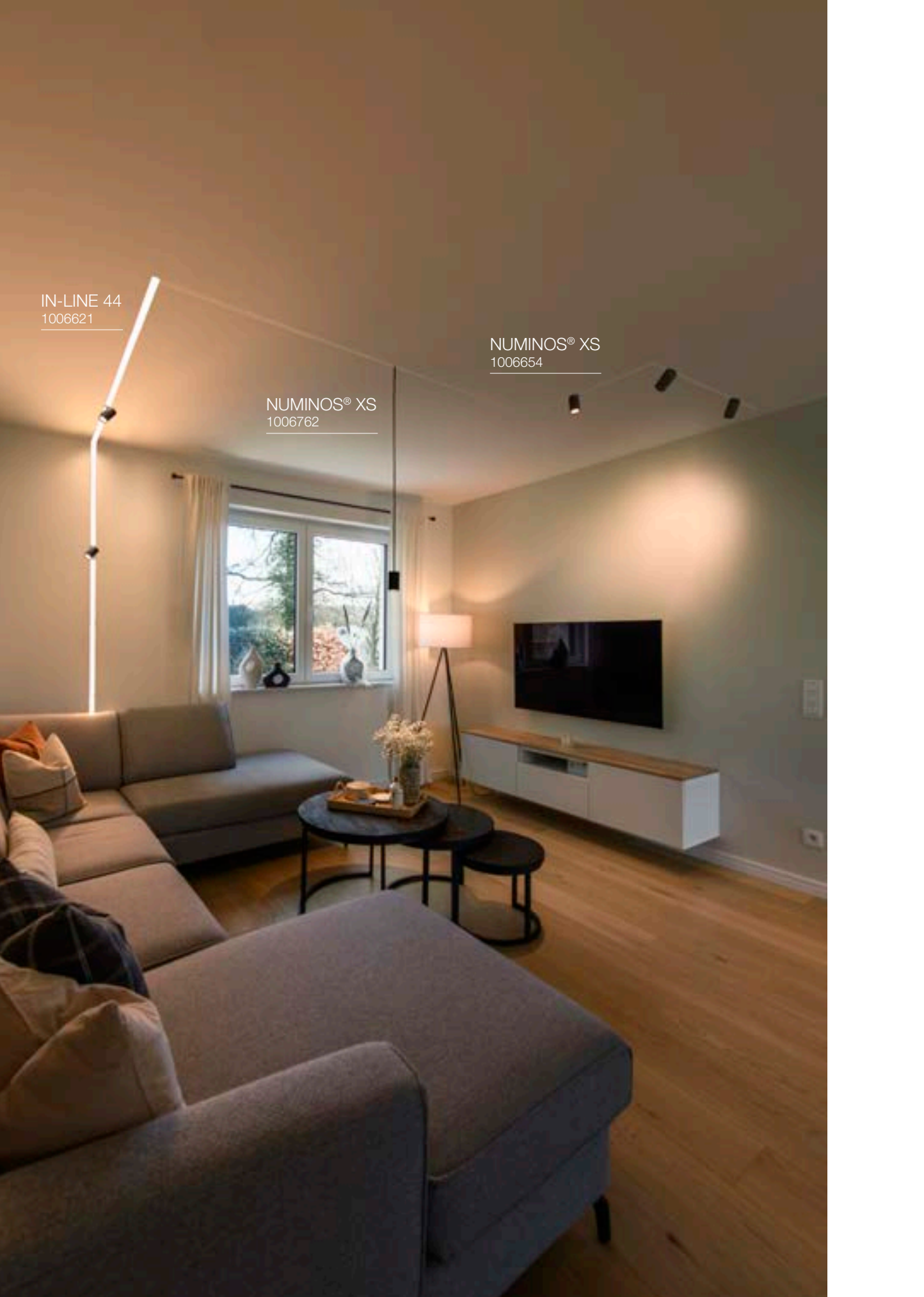













INTERIOR | SISTEMAS DE 48V(DC)

 <p><b>NEW</b></p>	 <p><b>NEW</b></p>	 <p><b>NEW</b></p>	 <p><b>NEW</b></p>	 <p><b>NEW</b></p>	 <p><b>NEW</b></p>
<p><b>LED</b></p> <p>NUMINOS® XS   468</p>	<p><b>LED</b></p> <p>NUMINOS® S   468</p>	<p><b>LED</b></p> <p>NUMINOS® XS   470</p>	<p><b>LED</b></p> <p>NUMINOS® S   470</p>	<p><b>LED</b></p> <p>IN-LINE 22   473</p>	<p><b>LED</b></p> <p>IN-LINE 22   475</p>
 <p><b>NEW</b></p>	 <p><b>NEW</b></p>	 <p><b>NEW</b></p>	 <p><b>NEW</b></p>		
<p><b>LED</b></p> <p>IN-LINE 44   475</p>	<p><b>LED</b></p> <p>IN-LINE 44   475</p>	<p><b>LED</b></p> <p>IN-LINE 24   477</p>	<p><b>LED</b></p> <p>IN-LINE 46   477</p>		

INTERIOR | SISTEMAS DE 12V(AC)































					
<p><b>SCKET</b></p> <p>ASMARA   486</p>	<p><b>SCKET</b></p> <p>TELESKOP   486</p>	<p><b>SCKET</b></p> <p>COSMIC   487</p>	<p><b>SCKET</b></p> <p>SYROS   489</p>	<p><b>SCKET</b></p> <p>SALUNA   489</p>	<p><b>LED</b></p> <p>DURNO   489</p>
					
<p><b>LED</b></p> <p>PLYTTA   490</p>	<p><b>LED</b></p> <p>NOBLO® SPOT   491</p>	<p><b>LED</b></p> <p>COMET LED   491</p>	<p><b>SCKET</b></p> <p>COMET   491</p>		

NOBLO® SPOT  
1007352





INTERIOR | SISTEMAS MONOFÁSICOS

					
LED NOBLO® SPOT   501	LED NOBLO® SPOT   501	LED NOBLO® SPOT   503	LED NOBLO® SPOT   503	SCKET ASTO TUBE   505	SCKET PANTILO ROPE 19   505
					
LED HELIA 50 TRACK   507	LED PANEL TRACK   507	LED PANEL TRACK   507	SCKET PARA CONE GL   508	SCKET PARA CONE GL   508	SCKET PARA CONE 14   509
					
SCKET PARA CONE 14   509	SCKET TONGA®   511	SCKET LIGHT EYE® 90   511	SCKET LIGHT EYE® 150   511	SCKET FORCHINI M 40 TRACK   512	SCKET PURI TRACK   513
					
SCKET PURI TRACK   513	SCKET PURI TRACK   515	SCKET AVO TRACK   515	LED ENOLA C TRACK   516	LED ENOLA C TRACK   517	SCKET ENOLA B TRACK   517
					
SCKET ENOLA B   517	SCKET BIMA   519	SCKET BIMA   519	LED KALU TRACK   520	SCKET KALU TRACK   520	SCKET EURO SPOT TRACK   521
					
SCKET ALTRA DICE TRACK   521					

TS V  
1007655







INTERIOR | SISTEMAS TRIFÁSICOS



Encontre a família NUMINOS® nas páginas 110–115

LED



Encontre a família ONE® nas páginas 194–195

LED



TS V | 543



TS V | 543



LED

NOBLO® SPOT | 545



LED

NOBLO® SPOT | 545



LED

NOBLO® SPOT | 547



LED

NOBLO® SPOT | 547



SCKET  
PANTILLO  
ROPE 19 | 549



LED  
SIGHT TRACK | 550



LED  
SIGHT TRACK | 550



LED  
SIGHT MOVE | 551



LED  
SIGHT MOVE | 551



SCKET  
PARA CONE GL | 552



SCKET  
PARA CONE GL | 552



SCKET  
PARA CONE 14 | 553



SCKET  
PARA CONE 14 | 553



SCKET  
FORCHINI M 40  
TRACK | 554



LED  
EURO CUBE | 555



SCKET  
EURO SPOT  
TRACK | 555



SCKET  
EURO SPOT  
TRACK | 555



SCKET  
ALTRA DICE  
TRACK | 556



SCKET  
PURI TRACK | 557



SCKET  
PURI TRACK  
GLASS | 557



LED  
KALU TRACK  
LED | 558



SCKET  
KALU TRACK | 558



SCKET  
BIMA | 559



SCKET  
BIMA | 559



LED  
HELIA 50 TRACK | 561



LED  
ENOLA C TRACK | 561



SCKET  
AVO TRACK | 561

GRAZIA PRO  
FLEXSTRIP  
1007352

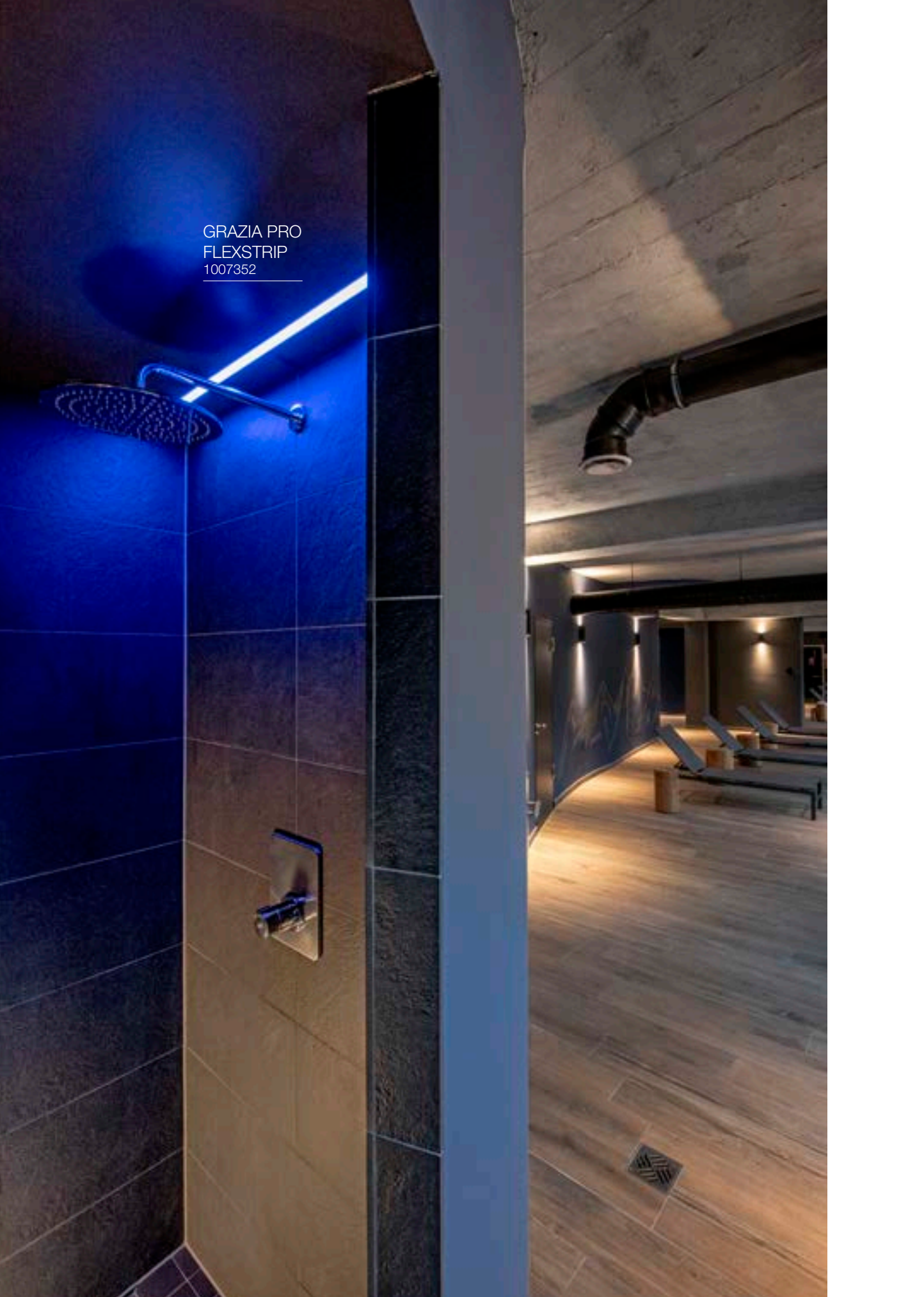

PERFIS



GRAZIA 10 PERFIL SALIENTE | 567



GRAZIA 10 PERFIL PARA ENCASTRAR | 567



GRAZIA 10 EDGE | 570

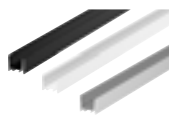

GRAZIA 20 PERFIL SALIENTE | 573



GRAZIA 20 PERFIL PARA ENCASTRAR | 573



GRAZIA 60 PERFIL SALIENTE | 577

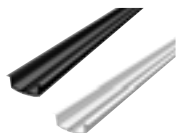

GRAZIA 60 PERFIL PARA ENCASTRAR | 577



GRAZIA 10 ACESSÓRIOS | 569



GRAZIA 10 EDGE ACESSÓRIOS | 571



GRAZIA 20 ACESSÓRIOS | 574-575



GRAZIA 60 ACESSÓRIOS | 578-579

TIRAS DE LED



GRAZIA FLEXSTRIP LED | 582



GRAZIA PRO FLEXSTRIP LED | 583



GRAZIA PRO MAX FLEXSTRIP | 585



GRAZIA PRO FLEXSTRIP TUNABLE WHITE | 587



GRAZIA PRO FLEXSTRIP RGBW | 589



GRAZIA IP FLEXSTRIP | 591



GRAZIA FLEXSTRIP LED ACESSÓRIOS | 582



GRAZIA PRO FLEXSTRIP LED ACESSÓRIOS | 583



GRAZIA PRO MAX FLEXSTRIP ACESSÓRIOS | 585



GRAZIA PRO FLEXSTRIP TUNABLE WHITE ACESSÓRIOS | 587



GRAZIA PRO FLEXSTRIP RGBW ACESSÓRIOS | 589

TAHA  
1007380



MEDO® PRO 90  
1007309

---



ABRIDOR



**LED**  
ABRIDOR 60/100 | 681



**LED**  
ABRIDOR  
SENSOR | 770



**LED**  
ABRIDOR | 770

ADEGAN



**SCKET**  
ADEGAN  
MANILA | 663



**SCKET**  
ADEGAN | 663

AINOS



**LED**  
AINOS | 812-813



**LED**  
AINOS | 813



**LED**  
AINOS | 813

ALPA



**SCKET**  
ALPA MUSHROOM  
45/75 | 665



**SCKET**  
ALPA CONE 100 | 665

ALTRA DICE



**SCKET**

ALTRA DICE | 263



**SCKET**

ALTRA DICE | 263



**SCKET**

ALTRA DICE | 408



**SCKET**

ALTRA DICE  
TRACK | 521



**SCKET**

ALTRA DICE  
TRACK | 556

ANELA



**LED**

ANELA | 261



**LED**

ANELA | 306

ARROCK



**SCKET**

ARROCK  
GRANITE 40/70 | 647



**SCKET**

ARROCK ARC | 648



**LED**

ARROCK  
STONE 50/75 | 649



**SCKET**

ARROCK SLOT | 649

ASTINA



**SCKET**

ASTINA | 261



**SCKET**

ASTINA | 305



ASTINA  
UP/DOWN | 379



**SCKET**

ASTINA | 761



**SCKET**

ASTINA STEEL | 761

ASTO



**SCKET**

ASTO TUBE | 285



**SCKET**

ASTO TUBE | 285



**SCKET**

ASTO TUBE | 285



**SCKET**

ASTO TUBE | 285



NEW

**SCKET**

ASTO TUBE | 347



NEW

**SCKET**

ASTO TUBE | 347



NEW

**SCKET**

ASTO TUBE | 395



NEW

**SCKET**

ASTO TUBE | 397



NEW

**SCKET**

ASTO TUBE | 397



NEW

**SCKET**

ASTO TUBE | 399



NEW

**SCKET**

ASTO TUBE | 397



**SCKET**

ASTO | 415



**SCKET**

ASTO | 415



**SCKET**

ASTO | 415



NEW

**SCKET**

ASTO TUBE | 505

AVO



**SCKET**

AVO | 413



**SCKET**

AVO | 413



**SCKET**

AVO | 413



**SCKET**

AVO | 413



**SCKET**

AVO | 415



**SCKET**

AVO TRACK | 515/561

BIMA



**SCKET**

BIMA | 519



**SCKET**

BIMA | 519



**SCKET**

BIMA | 559



**SCKET**

BIMA | 559





BOOKAT



LED

BOOKAT | 751



LED

BOOKAT | 683

BOX



SCKET

BOX-L | 773



LED

BOX-L | 773



SCKET

BOX UP/DOWN | 773

BRICK



LED

BRICK MESH | 825



LED

BRICK | 825



LED

BRICK | 825



SCKET

BRICK  
DOWNUNDER | 827



LED

BRICK  
DOWNUNDER | 827

BULAN



SCKET

BULAN | 815



SCKET

BULAN GRID | 815

CARISO



LED  
CARISO | 368



LED  
CARISO | 368

CONCRETO



SCKET  
CONCRETO | 627



SCKET  
CONCRETO | 627



NEW

LED  
CONCRETO M | 717



NEW

LED  
CONCRETO L | 717



NEW

SCKET  
CONCRETO | 821



NEW

LED  
CONCRETO | 821

CONTONE®



LED  
CONTONE® | 231



LED  
CONTONE® | 231

CUBE



NEW

LED  
S-CUBE 35/75 | 607



NEW

LED  
R-CUBE 35/70 | 609



NEW

LED  
S-CUBE | 791



NEW

LED  
R-CUBE | 805



NEW

LED  
S-CUBE | 805



DASAR®



**LED**  
DASAR® 600 | 831



**LED**  
DASAR® 1200 | 831



**LED**  
DASAR® S | 833



**LED**  
DASAR® S | 833



**LED**  
DASAR® L | 835



**LED**  
DASAR® L | 835



**LED**  
DASAR® XL | 837



**LED**  
DASAR® XL | 837



**LED**  
DASAR® FLAT 80 | 839



**LED**  
DASAR® FLAT 120 | 839



**LED**  
DASAR® 255 | 839



**LED**  
DASAR® 920 | 840



**LED**  
DASAR® 920 | 840



**LED**  
DASAR® 270 | 841



**LED**  
DASAR® 270 | 841



**SCKET**  
DASAR® 115 | 843



**SCKET**  
DASAR® 115 | 843



**SCKET**  
DASAR® 115 | 843



**SCKET**  
DASAR® EXACT 116 | 845



**SCKET**  
DASAR® EXACT 116 | 845



**SCKET**  
DASAR® 215 | 846



**SCKET**  
DASAR® 215 | 846



**SCKET**  
DASAR® 215 | 847



**LED**  
DASAR® 215 | 847



**LED**  
DASAR® PROJECTOR | 698



**LED**  
DASAR® 920 | 698

DIO FLEX



**SCKET**  
DIO FLEX PLATE | 387



**LED**  
DIO FLEX PLATE | 387



**LED**  
DIO FLEX PLATE | 387

DOLIX



**SCKET**

DOLIX OUT | 235



**SCKET**

DOLIX OUT | 235

DOWNUNDER OUT



**LED**

DOWNUNDER  
OUT | 769



**LED**

DOWNUNDER  
OUT | 769



**LED**

DOWNUNDER  
OUT S | 823



**LED**

DOWNUNDER  
OUT M | 823



**LED**

DOWNUNDER  
OUT L | 823

ENOLA



**SCKET**

ENOLA B | 259



**LED**

ENOLA C | 259



**SCKET**

ENOLA B | 305



**SCKET**

ENOLA | 305



ENOLA B | 379



ENOLA B | 379



**SCKET**

ENOLA B | 407



**SCKET**

ENOLA B | 407



**SCKET**

ENOLA B | 407



**LED**

ENOLA C TRACK | 516



**LED**

ENOLA C TRACK | 517



**SCKET**

ENOLA B TRACK | 517



**SCKET**

ENOLA B | 517



**LED**

ENOLA C TRACK | 561



NEW

**LED**

ENOLA  
OCULUS | 723



NEW

**LED**

ENOLA  
OCULUS | 723



**LED**

ENOLA  
OCULUS S | 725



**LED**

ENOLA  
OCULUS M | 725



LED  
ENOLA  
ROUND L | 725



LED  
ENOLA ROUND S  
UP/DOWN | 727



LED  
ENOLA ROUND M  
UP/DOWN | 727



LED  
ENOLA ROUND L  
UP/DOWN | 727



LED  
ENOLA  
SQUARE S | 729



LED  
ENOLA  
SQUARE M | 729



LED  
ENOLA  
SQUARE L | 729



LED  
ENOLA SQUARE S  
UP/DOWN | 730



LED  
ENOLA SQUARE M  
UP/DOWN | 730



LED  
ENOLA SQUARE L  
UP/DOWN | 730



LED  
ENOLA  
OCULUS | 792



LED  
ENOLA  
ROUND S | 793



LED  
ENOLA  
ROUND M | 793



LED  
ENOLA  
ROUND L | 793



LED  
ENOLA  
SQUARE S | 795



LED  
ENOLA  
SQUARE M | 795



LED  
ENOLA S  
QUARE L | 795

ESKINA



LED  
ESKINA  
FRAME 45/75 | 629



LED  
ESKINA  
FRAME 75 | 629



LED  
ESKINA FRAME  
125/175 | 630



LED  
ESKINA 30/80 | 631



LED  
ESKINA FRAME | 749



LED  
ESKINA FRAME | 749



LED  
ESKINA FRAME | 749



LED  
ESKINA D | 783



LED  
ESKINA FRAME | 791



LED  
ESKINA SPOT  
SENSOR | 807



LED  
ESKINA SPOT | 807

EURO SPOT



**SCKET**

EURO SPOT  
TRACK | 521



**SCKET**

EURO SPOT  
TRACK | 555



**SCKET**

EURO SPOT  
TRACK | 555

FENDA



**SCKET**

FENDA | 266



**SCKET**

FENDA | 296



**SCKET**

FENDA | 447



**SCKET**

FENDA | 447



**SCKET**

FENDA | 447



**SCKET**

FENDA | 448



**SCKET**

FENDA BOW  
BASIS | 448



**SCKET**

FENDA | 380



FENDA | 380



FENDA | 296



FENDA | 296, 448



FENDA | 267, 297, 449



FENDA | 267, 297, 449



FENDA | 267, 297, 449

FITU



**SCKET**

FITU | 295



**SCKET**

FITU | 376



**SCKET**

FITU CUBE | 376

FLATT



LED

FLATT 65/100 | 679



LED

FLATT SENSOR | 760



LED

FLATT | 760

FORCHINI



SCKET

FORCHINI 50 | 312



SCKET

FORCHINI 70 | 312



SCKET

FORCHINI M 40 | 313



SCKET

FORCHINI M 50 | 313



SCKET

FORCHINI M 40  
TRACK | 512



SCKET

FORCHINI M 40  
TRACK | 554

F-POL



SCKET

F-POL | 672



SCKET

F-POL | 778

GLENOS®



LED

GLENOS® | 291



LED

GLENOS® | 291



LED

GLENOS® 60 | 339

GLOO PURE



**SCKET**

GLOO PURE  
27/44/70 | 655



**SCKET**

GLOO PURE | 777

GRAFIT



**SCKET**

GRAFIT 30/60/90 | 635



**SCKET**

GRAFIT 30/60/90 | 637



**SCKET**

GRAFIT | 742



**SCKET**

GRAFIT | 742



**SCKET**

GRAFIT | 743



**SCKET**

GRAFIT | 743

HELIA



**LED**

HELIA  
AMBIENT 35 | 300



**LED**

HELIA  
AMBIENT 35 | 300



**LED**

HELIA 30 | 301



**LED**

HELIA 30 | 301



**LED**

HELIA 40 | 303



**LED**

HELIA 40 | 303



**LED**

HELIA 50 TRACK | 507



**LED**

HELIA 50 TRACK | 561



**LED**

HELIA SPOT S | 699



**LED**

HELIA SPOT L | 699



**LED**

HELIA | 809



**LED**

HELIA | 809





HORN



**LED**  
HORN MINI | 218



**SCKET**  
HORN | 219



**SCKET**  
HORN | 219



**SCKET**  
HORN | 219



**SCKET**  
HORN | 220



**SCKET**  
HORN | 220



**SCKET**  
HORN | 220



**SCKET**  
HORN-T | 221



**LED**  
HORN MAGNA | 221

H-POL



**LED**  
H-POL 30/60 | 676



**LED**  
H-POL TWIN  
30/60 | 677

IPERI



**LED**  
IPERI 50 | 681



**LED**  
IPERI | 780

I-RING



NEW

LED  
I-RING | 613



NEW

LED  
I-RING | 714

KADUX



NEW

LED  
KADUX | 213



NEW

SCKET  
KADUX | 213



NEW

LED  
KADUX | 213



SCKET  
KADUX | 214



SCKET  
KADUX | 214



SCKET  
KADUX | 214



SCKET  
KADUX | 215



SCKET  
KADUX | 215

KALU



LED  
KALU | 403



LED  
KALU | 403



LED  
KALU | 403



LED  
KALU | 403



SCKET  
KALU | 405



SCKET  
KALU | 405



SCKET  
KALU | 405



SCKET  
KALU | 405



LED  
KALU TRACK | 520



SCKET  
KALU TRACK | 520



LED  
KALU TRACK  
LED | 558



SCKET  
KALU TRACK | 558

KARDAMOD



**SCKET**

KARDAMOD | 265



**SCKET**

KARDAMOD | 265

KARPO



**LED**

KARPO 30 | 232



**LED**

KARPO MAGN | 382



**LED**

KARPO GOOSE | 382



**LED**

KARPO 30 | 383



**LED**

KARPO | 383



**LED**

KARPO 30 | 399



**LED**

KARPO | 452



**LED**

KARPO | 452

LALU®



NEW

**LED**

LALU® | 177



NEW

**LED**

LALU® | 177



NEW

LALU® TETRA 14 | 178



NEW

LALU® TETRA 24 | 178



NEW

LALU® TETRA 36 | 178



NEW

LALU® CONE 15 | 178



NEW

LALU® ELYPSE 15 | 178



NEW

LALU® ELYPSE 22 | 178



NEW

LALU® ELYPSE 33 | 178



NEW

LALU® PLATE 15 | 178



NEW

LALU® PLATE 22 | 178



NEW

**SCKET**

LALU® | 183

LID



**LED**  
LID I 75 | 611

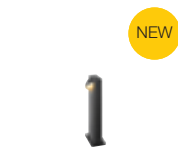

**LED**  
LID I 45 | 611

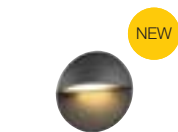

**LED**  
LID II | 711

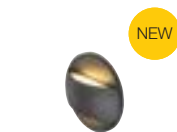

**LED**  
LID II | 711



**LED**  
LID I | 713



**LED**  
LID I | 713

LIGHT EYE



**SCKET**  
LIGHT EYE® 90 | 314



**SCKET**  
LIGHT EYE® 150 | 314



**SCKET**  
LIGHT EYE® 90 | 511



**SCKET**  
LIGHT EYE® 150 | 511

LIPSY



**LED**  
LIPSY® 30 | 423



**LED**  
LIPSY® 40 | 423



**LED**  
LIPSY® 50 | 423



**LED**  
LIPSY® 30 | 425



**LED**  
LIPSY® 40 | 425



**LED**  
LIPSY® 50 | 425



**LED**  
LIPSY® 40 | 426



**LED**  
LIPSY® 50 | 426

LISENNE



**SOCKET**  
LISENNE | 306



**SOCKET**  
LISENNE | 375



**SOCKET**  
LISENNE 40/70 | 662

L-LINE



**LED**  
L-LINE 60 | 341



**LED**  
L-LINE 120 | 341



**LED**  
L-LINE OUT 30 | 650



**LED**  
L-LINE OUT 60 | 651



**LED**  
L-LINE  
OUT 50/80 | 651



**LED**  
L-LINE OUT | 775

LOGS



**LED**  
LOGS IN | 362



**LED**  
LOGS IN | 362



**LED**  
LOGS IN L | 363



**LED**  
LOGS IN L | 363



**LED**  
LOGS 40/70 | 633



**LED**  
LOGS | 775

MAGANDA



**LED**  
MAGANDA | 337



**LED**  
MAGANDA | 453

MEDO® PRO 40  
1006414 (DC)

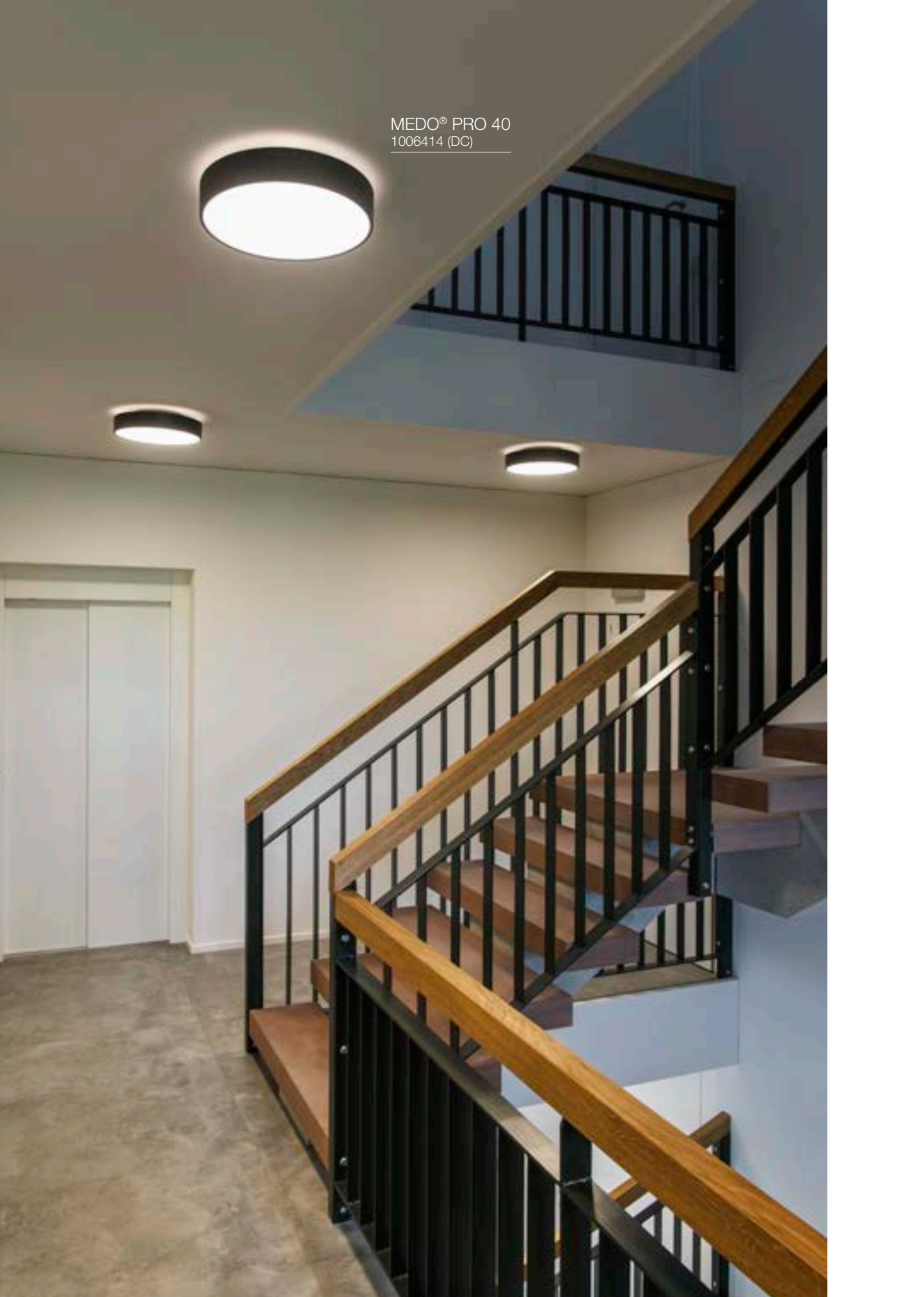



MANA



LED  
MANA  
BASE | 349, 720



MANA BASE | 349



MANA 40 | 319



MANA 60 | 349



LED  
MANA | 351



MANA | 351



MANA | 351



LED  
MANA | 353



LED  
MANA | 353



MANA | 353



MANA | 353



RUSTY® MANA | 720



RUSTY® MANA | 720



LED  
MANA OUT | 721



LED  
MANA OUT | 721

MEDO



LED  
MEDO® PRO  
30 | 150, 152, 157



LED  
MEDO® PRO  
40 | 150, 152, 157



LED  
MEDO® PRO  
60 | 151, 153, 157



LED  
MEDO® PRO  
90 | 151, 153, 157



LED  
MEDO® 30 | 161



LED  
MEDO® 40 | 161



LED  
MEDO® 60 | 161



LED  
MEDO® 90 | 161

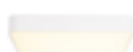

LED  
MEDO® 60 | 165



LED  
MEDO® RING 60 | 167



LED  
MEDO® RING 90 | 167



LED  
MEDO® 30 | 170



LED  
MEDO® 40 | 170



LED  
MEDO® 60 | 170



LED  
MEDO® 30 | 171



LED  
MEDO® 40 | 171



LED  
MEDO® 60 | 171

MERIDIAN



**SCKET**

MERIDIAN | 746



**SCKET**

MERIDIAN BOX | 746



**SCKET**

MERIDIAN BOX  
SENSOR | 747



**SCKET**

MERIDIAN BOX | 747

MOLAT



**SCKET**

MOLAT | 661



**SCKET**

MOLAT | 661



**SCKET**

MOLAT | 777



**SCKET**

MOLAT | 799

M-POL



**LED**

M-POL S | 614

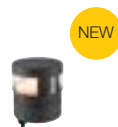

**LED**

M-POL S | 615



**LED**

M-POL S | 616



**LED**

M-POL S | 617



**LED**

M-POL S | 618



**LED**

M-POL M | 619



**LED**

M-POL M | 620



**LED**

M-POL M | 621



M-POL 30/60/90 | 623





MYRA



**SCKET**

MYRA SPOT | 685



**SCKET**

MYRA  
UP/DOWN | 764



**SCKET**

MYRA | 811

NAUTILUS



**SCKET**

NAUTILUS 10 | 694



**SCKET**

BIG NAUTILUS | 694



**SCKET**

NAUTILUS 10 | 695



**LED**

NAUTILUS 10 | 696



**SCKET**

NAUTILUS | 697



**SCKET**

NAUTILUS 10  
SPOT | 697



**LED**

NAUTILUS 10  
SPOT LED | 697



**SCKET**

NAUTILUS | 785

NEW TRIA®

NEW



**LED**

NEW TRIA®  
68 | 134, 135

NEW



**LED**

NEW TRIA®  
68 | 134, 135

NEW



**LED**

NEW TRIA® UNIVERSAL  
68 | 136, 137

NEW



**LED**

NEW TRIA® UNIVERSAL  
68 | 136, 137

NEW



**LED**

NEW TRIA® 75 | 137

NEW



**LED**

NEW TRIA® 68 | 138

NEW



**LED**

NEW TRIA® 68 | 138

NEW



**LED**

NEW TRIA® 75 | 138

NEW



**LED**

NEW TRIA® 75 | 138

NEW



**LED**

NEW TRIA® 75 XL | 139

NEW



**LED**

NEW TRIA® 75 XL | 139

NEW TRIA®



LED  
NEW TRIA® 45 | 141



LED  
NEW TRIA® 155 | 141



LED  
NEW TRIA® 150 | 145



LED  
NEW TRIA® 150 | 145



LED  
NEW TRIA® 155 | 145



LED  
NEW TRIA® 300 | 145

NOBLO®



LED  
NOBLO® | 401



LED  
NOBLO® | 401



LED  
NOBLO® | 401



LED  
NOBLO® SPOT | 491



LED  
NOBLO® SPOT | 501



LED  
NOBLO® SPOT | 501



LED  
NOBLO® SPOT | 503



LED  
NOBLO® SPOT | 503



LED  
NOBLO® SPOT | 545



LED  
NOBLO® SPOT | 545



LED  
NOBLO® SPOT | 547



LED  
NOBLO® SPOT | 547

NUMINOS®



LED  
NUMINOS® XS | 84



LED  
NUMINOS® S | 84



LED  
NUMINOS® M | 85



LED  
NUMINOS® L | 85



LED  
NUMINOS® XL | 85



LED  
NUMINOS® MOVE  
XS | 86



LED  
NUMINOS® MOVE  
S | 86



LED  
NUMINOS® MOVE  
M | 87



LED  
NUMINOS® MOVE  
L | 87



LED  
NUMINOS® MOVE  
XL | 87



NUMINOS® GIMBLE XS | 88



NUMINOS® GIMBLE S | 88



NUMINOS® GIMBLE M | 89



NUMINOS® GIMBLE L | 89



NUMINOS® GIMBLE XL | 89



NEW



NUMINOS® PROJECTOR XS | 92



NEW



NUMINOS® PROJECTOR S | 92



NEW



NUMINOS® PROJECTOR M | 93



NEW



NUMINOS® PROJECTOR XL | 93



NUMINOS® S | 100



NUMINOS® M | 100



NUMINOS® L | 101



NUMINOS® XL | 101



NUMINOS® S | 104



NUMINOS® M | 104



NUMINOS® L | 105



NUMINOS® XL | 105



NUMINOS® S | 108



NUMINOS® M | 108



NUMINOS® L | 109



NUMINOS® XL | 109



NUMINOS® S | 112



NUMINOS® M | 112



NUMINOS® L | 113



NUMINOS® XL | 113



NUMINOS® ZOOM M | 115

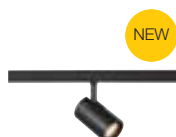

NEW



NUMINOS® 48V XS | 468



NEW



NUMINOS® 48V S | 468



NEW



NUMINOS® 48V XS | 470



NEW



NUMINOS® 48V S | 470

OCCULDAS



LED  
OCCULDAS 14 | 230



LED  
OCCULDAS 23 | 230



LED  
OCCULDAS 13 | 262



LED  
OCCULDAS 23 | 262

OCULUS



LED  
OCULUS | 229



LED  
OCULUS | 258



LED  
OCULUS | 294



NEW

LED  
OCULUS | 355

ONE®



LED  
ONE® 60 | 188



LED  
ONE® 60 | 188



LED  
ONE® 80 | 188



LED  
ONE® 80 | 188



LED  
ONE® DOUBLE | 189



LED  
ONE® TRIPLE | 189



NEW

LED  
ONE® CUBE | 189



NEW

LED  
ONE® CUBE | 189



LED  
ONE® LINEAR 100 | 191



LED  
ONE® LINEAR 140 | 191



LED  
ONE® 40 | 193



LED  
ONE® 60 | 193



LED  
ONE® 40 TRACK | 194



NEW

LED  
ONE® STRAIGHT | 196



NEW

LED  
ONE® BOW | 197

OVALISK



**LED**  
OVALISK 75/100 | 653



**LED**  
OVALISK  
SENSOR | 757



**LED**  
OVALISK | 757



**LED**  
OVALISK | 797

PANEL



**LED**  
LED PANEL | 243

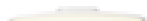

**LED**  
PANEL 60 | 274



**LED**  
PANEL | 275

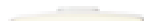

**LED**  
PANEL 60 | 275



**LED**  
PANEL | 275



**LED**  
PANEL 60 | 289



**LED**  
PANEL TRACK | 507



**LED**  
PANEL TRACK | 507

PANTILO



**SCKET**  
PANTILO  
ROPE 19 | 279



**SCKET**  
PANTILO  
ROPE 20 | 279



**SCKET**  
PANTILO  
ROPE 27 | 279



**SCKET**  
PANTILO  
OVAL | 281



**SCKET**  
PANTILO 20 | 281



**SCKET**  
PANTILO 28 | 281



**SCKET**  
PANTILO  
CONVEX 29/40 | 283

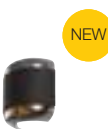

**SCKET**  
PANTILO  
ROPE | 345



**SCKET**  
PANTILO  
ROPE 19 | 393



**SCKET**  
PANTILO  
ROPE 27 | 393



**SCKET**  
PANTILO  
ROPE 19 | 505



**SCKET**  
PANTILO  
ROPE 19 | 549

PARA



**SCKET**

PARA DOME | 318



PARA DOME | 318



PARA DOME | 318



**SCKET**

PARA 380 | 319

PARA CONE



**SCKET**

PARA CONE GL | 309



**SCKET**

PARA CONE 20 | 309



**SCKET**

PARA CONE 30 | 309



**SCKET**

PARA CONE GL | 508



**SCKET**

PARA CONE GL | 508



**SCKET**

PARA CONE 14 | 509



**SCKET**

PARA CONE 14 | 509



**SCKET**

PARA CONE GL | 552



**SCKET**

PARA CONE GL | 552



**SCKET**

PARA CONE 14 | 553



**SCKET**

PARA CONE 14 | 553

PATTA



**LED**

PATTA-I | 244



**LED**

PATTA-I | 244



**LED**

PATTA-I | 245



**LED**

PATTA-I | 245



**LED**

PATTA-F | 246



**LED**

PATTA-F | 247

PEMA



**LED**  
PEMA® | 758



**LED**  
PEMA® | 759



**LED**  
PEMA® | 759



**SCKET**  
PEMA® | 759

PHELIA



**SCKET**  
PHELIA 10 | 310



**SCKET**  
PHELIA 20 | 311



**SCKET**  
PHELIA 25 | 311



**SCKET**  
PHELIA 30 | 311



**SCKET**  
PHELIA | 388



**SCKET**  
PHELIA | 453

PHOTONI



**SCKET**  
PHOTONI 45/75 | 605



**SCKET**  
PHOTONI | 709

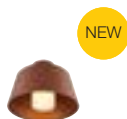

**SCKET**  
PHOTONI | 789

PHOTONIA



**SCKET**  
PHOTONIA | 659



**SCKET**  
PHOTONIA | 659



**SCKET**  
PHOTONIA | 777



**SCKET**  
PHOTONIA | 799

PIKA



**SCKET**

PIKA | 228



**SCKET**

PIKA | 228

PLASTRA



**SCKET**

PLASTRA | 233



**SCKET**

PLASTRA | 233



**SCKET**

PLASTRA | 270



**LED**

PLASTRA | 271



**SCKET**

PLASTRA 105 | 271



**SCKET**

PLASTRA 104 | 271



**SCKET**

PLASTRA | 356



**SCKET**

PLASTRA | 356



**SCKET**

PLASTRA | 357



**SCKET**

PLASTRA | 357



**SCKET**

PLASTRA | 359



**LED**

PLASTRA | 359



**LED**

PLASTRA | 359



**SCKET**

PLASTRA | 360



**SCKET**

PLASTRA 101 | 361



**SCKET**

PLASTRA | 361



**SCKET**

PLASTRA 104 | 361

POWER TRAIL-LITE



**LED**

POWER TRAIL-LITE® | 849



**LED**

POWER TRAIL-LITE® | 849



PURI



**SCKET**

PURI | 411



**SCKET**

PURI | 411



**SCKET**

PURI | 411



**SCKET**

PURI | 411



**SCKET**

PURI TRACK | 513



**SCKET**

PURI TRACK | 513



**SCKET**

PURI TRACK | 515



**SCKET**

PURI TRACK | 557



**SCKET**

PURI TRACK  
GLASS | 557

Q-LINE®



**LED**

Q-LINE® | 253



**LED**

Q-LINE® | 253



**LED**

Q-LINE® | 293



**LED**

Q-LINE® | 293



**LED**

Q-LINE® | 293



**LED**

Q-LINE® | 341

QUAD



**LED**

QUAD FRAME 9 | 240



**LED**

QUAD FRAME 14 | 364



**LED**

QUAD FRAME 19 | 364



**LED**

BIG QUAD | 752



**LED**

QUAD | 752



**LED**

QUAD  
UP/DOWN 15 | 753



**LED**

BIG QUAD  
UP/DOWN | 755



**LED**

BIG QUAD | 755

QUADRASS



**SCKET**

QUADRASS | 307



**SCKET**

QUADRASS | 375



**LED**

QUADRASS  
SPOT | 375

QUADRASYL



**SCKET**

QUADRASYL 75 | 682



**SCKET**

QUADRASYL | 781

QUADRULO



**LED**

QUADRULO | 639



NEW

**LED**

QUADRULO | 744



**SCKET**

QUADRULO  
SENSOR | 745



**SCKET**

QUADRULO | 745



**LED**

QUADRULO | 811

RASCALI



**LED**

RASCALI 45/65 | 684



**LED**

RASCALI | 780

ROCCI



LED

ROCCI | 854



LED

ROCCI | 854



LED

ROCCI 200 | 855



LED

ROCCI 200 | 855

ROTOBALL



SCKET

ROTOBALL 25 | 317



SCKET

ROTOBALL 40 | 317



SCKET

ROTOBALL 50 | 317



SCKET

ROTOBALL  
25/40/50 | 657

ROX



SCKET

ROX ACRYL  
30/60/90 | 669



SCKET

ROX UP/DOWN | 767



SCKET

ROX | 767



SCKET

ROX | 801



SCKET

ROX | 801

RUSTY®



SENDER



SIGHT



SIMA



LED

SIMA | 420



LED

SIMA | 420



LED

SIMA | 421

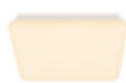

LED

SIMA | 421

SITRA



SCKET

SITRA 360 | 685



SCKET

SITRA 360 SPIKE | 703



SCKET

SITRA 360 SPIKE | 703



LED

SITRA S | 739



LED

SITRA S | 739



LED

SITRA M | 741



LED

SITRA L | 741



SCKET

SITRA CUBE | 741



SCKET

SITRA | 801



SCKET

SITRA 360 | 808



LED

SITRA  
UP/DOWN | 765



SCKET

SITRA  
UP/DOWN | 765

SLOTS



LED

SLOTS 45/65 | 675



LED

SLOTS | 768

SOLASTO



**SCKET**

SOLASTO | 857



**SCKET**

SOLASTO | 857

SOMNILA



**LED**

SOMNILA SPOT | 384



**LED**

SOMNILA SPOT | 385



**LED**

SOMNILA FLEX | 385



**LED**

SOMNILA FLEX | 385

SQUARE



**SCKET**

SQUARE  
POLE 30/60/90 | 673



**SCKET**

SQUARE | 779



**SCKET**

SQUARE TURN | 781

S-TUBE



**SCKET**

S-TUBE 32/75 | 603



**SCKET**

S-TUBE | 805



SUN



**SCKET**

SUN / BIG SUN | 315



NEW

**SCKET**

TINY SUN | 443



NEW

**SCKET**

LITTLE SUN | 443

SYNA



NEW

**LED**

SYNA PLANT | 689



NEW

**LED**

SYNA GARDEN | 689



**LED**

SYNA | 689

THEO



**SCKET**

THEO UP/DOWN | 377



**SCKET**

THEO PATHLIGHT | 652



**SCKET**

THEO BRACKET | 701



**SCKET**

THEO UP/DOWN | 735



**LED**

BIG THEO BEAM UP/FLOOD DOWN | 735



**SCKET**

BIG THEO UP/DOWN | 735



**LED**

BIG THEO FLOOD UP/DOWN | 736



**SCKET**

THEO | 736



**SCKET**

BIG THEO | 737



**LED**

BIG THEO | 737



**LED**

BIG THEO | 797



**SCKET**

BIG THEO | 797



**SCKET**

THEO BRACKET | 808

TRILEDO



**SOCKET**

TRILEDO | 255



**SOCKET**

TRILEDO | 255



**SOCKET**

TRILEDO | 255



**LED**

TRILEDO | 257



**LED**

TRILEDO | 257



**LED**

TRILEDO | 257

TRUKKO



**LED**

TRUKKO | 330



**LED**

TRUKKO | 330



NEW

**LED**

TRUKKO | 331



NEW

**LED**

TRUKKO 80 | 331

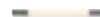

**LED**

TRUKKO 60 | 332



**LED**

TRUKKO 90 | 332

UNIVERSAL DOWNLIGHT



NEW

**LED**

UNIVERSAL  
DOWNLIGHT | 205



NEW

**LED**

UNIVERSAL  
DOWNLIGHT | 207



NEW

**LED**

UNIVERSAL  
DOWNLIGHT | 208



NEW

**LED**

UNIVERSAL  
DOWNLIGHT | 209

VILUA



**LED**

VILUA S | 763



**LED**

VILUA L | 763



**LED**

VILUA | 763



VINOLINA



**LED**  
VINOLINA  
ONE | 437, 597



**LED**  
VINOLINA |  
437,597



**LED**  
VINOLINA  
TWO | 439, 599

WL



**LED**  
WL 149 | 334



**SOCKET**  
WL 149 | 334



**SOCKET**  
WL 106 | 335



**SOCKET**  
WL 106 | 335

WORKLIGHT



**LED**  
WORKLIGHT  
PRO 120 | 287



**LED**  
WORKLIGHT  
PRO 150 | 287



**LED**  
WORKLIGHT  
PRO | 444



**LED**  
WORKLIGHT  
PRO | 444



**LED**  
WORKLIGHT | 445



**LED**  
WORKLIGHT | 445

NUMINOS® GIMBLE  
1005817



Descubra  
o configurador  
NUMINOS® em  
[slv.com](http://slv.com)

NUMINOS®  
Downlights (DL)



As cores de  
NUMINOS® podem  
ser seleccionadas  
individualmente



preto - preto



preto - branco



preto - cromado



branco - preto



branco - branco



branco - cromado



NUMINOS® GIMBLE  
355° rotação e 60° inclinação



NUMINOS® MOVE  
355° rotação  
e 30° inclinação



Conector de  
tensão reduzida

**XS** 200mA  
Consumo de energia: 7W  
Material: alumínio / policarbonato (PC)

**S** 250mA  
Consumo de energia: 8,6W  
Material: alumínio / policarbonato (PC)

2700K	20°	640lm	1005499	73,00 EUR	670lm	1003769	73,00 EUR
	40°	620lm	1005502	73,00 EUR	670lm	1003772	73,00 EUR
	55°	640lm	1005505	73,00 EUR	670lm	1003775	73,00 EUR
3000K	20°	700lm	1005517	73,00 EUR	690lm	1003793	73,00 EUR
	40°	670lm	1005520	73,00 EUR	690lm	1003796	73,00 EUR
	55°	690lm	1005523	73,00 EUR	690lm	1003799	73,00 EUR
4000K	20°	720lm	1005535	73,00 EUR	730lm	1003817	73,00 EUR
	40°	700lm	1005538	73,00 EUR	730lm	1003820	73,00 EUR
	55°	710lm	1005541	73,00 EUR	730lm	1003823	73,00 EUR
2700K	20°	670lm	1005500	73,00 EUR	720lm	1003770	73,00 EUR
	40°	650lm	1005503	73,00 EUR	720lm	1003773	73,00 EUR
	55°	670lm	1005506	73,00 EUR	720lm	1003776	73,00 EUR
3000K	20°	730lm	1005518	73,00 EUR	730lm	1003794	73,00 EUR
	40°	700lm	1005521	73,00 EUR	730lm	1003797	73,00 EUR
	55°	720lm	1005524	73,00 EUR	730lm	1003800	73,00 EUR
4000K	20°	750lm	1005536	73,00 EUR	790lm	1003818	73,00 EUR
	40°	730lm	1005539	73,00 EUR	790lm	1003821	73,00 EUR
	55°	740lm	1005542	73,00 EUR	790lm	1003824	73,00 EUR
2700K	20°	670lm	1005501	73,00 EUR	690lm	1003771	73,00 EUR
	40°	650lm	1005504	73,00 EUR	690lm	1003774	73,00 EUR
	55°	670lm	1005507	73,00 EUR	690lm	1003777	73,00 EUR
3000K	20°	730lm	1005519	73,00 EUR	700lm	1003795	73,00 EUR
	40°	700lm	1005522	73,00 EUR	700lm	1003798	73,00 EUR
	55°	720lm	1005525	73,00 EUR	700lm	1003801	73,00 EUR
4000K	20°	750lm	1005537	73,00 EUR	750lm	1003819	73,00 EUR
	40°	730lm	1005540	73,00 EUR	750lm	1003822	73,00 EUR
	55°	740lm	1005543	73,00 EUR	750lm	1003825	73,00 EUR
2700K	20°	640lm	1005508	73,00 EUR	670lm	1003781	73,00 EUR
	40°	620lm	1005511	73,00 EUR	670lm	1003784	73,00 EUR
	55°	640lm	1005514	73,00 EUR	670lm	1003787	73,00 EUR
3000K	20°	700lm	1005526	73,00 EUR	690lm	1003805	73,00 EUR
	40°	670lm	1005529	73,00 EUR	690lm	1003808	73,00 EUR
	55°	690lm	1005532	73,00 EUR	690lm	1003811	73,00 EUR
4000K	20°	720lm	1005544	73,00 EUR	730lm	1003829	73,00 EUR
	40°	700lm	1005547	73,00 EUR	730lm	1003832	73,00 EUR
	55°	710lm	1005550	73,00 EUR	730lm	1003835	73,00 EUR
2700K	20°	670lm	1005509	73,00 EUR	720lm	1003782	73,00 EUR
	40°	650lm	1005512	73,00 EUR	720lm	1003785	73,00 EUR
	55°	670lm	1005515	73,00 EUR	720lm	1003788	73,00 EUR
3000K	20°	730lm	1005527	73,00 EUR	730lm	1003806	73,00 EUR
	40°	700lm	1005530	73,00 EUR	730lm	1003809	73,00 EUR
	55°	720lm	1005533	73,00 EUR	730lm	1003812	73,00 EUR
4000K	20°	750lm	1005545	73,00 EUR	790lm	1003830	73,00 EUR
	40°	730lm	1005548	73,00 EUR	790lm	1003833	73,00 EUR
	55°	740lm	1005551	73,00 EUR	790lm	1003836	73,00 EUR
2700K	20°	670lm	1005510	73,00 EUR	690lm	1003783	73,00 EUR
	40°	650lm	1005513	73,00 EUR	690lm	1003786	73,00 EUR
	55°	670lm	1005516	73,00 EUR	690lm	1003789	73,00 EUR
3000K	20°	730lm	1005528	73,00 EUR	700lm	1003807	73,00 EUR
	40°	700lm	1005531	73,00 EUR	700lm	1003810	73,00 EUR
	55°	720lm	1005534	73,00 EUR	700lm	1003813	73,00 EUR
4000K	20°	750lm	1005546	73,00 EUR	750lm	1003831	73,00 EUR
	40°	730lm	1005549	73,00 EUR	750lm	1003834	73,00 EUR
	55°	740lm	1005552	73,00 EUR	750lm	1003837	73,00 EUR



<b>M</b> 500mA Consumo de energia: 17,5W Material: alumínio / policarbonato (PC)	<b>L</b> 700mA Consumo de energia: 25,4W Material: alumínio / policarbonato (PC)	<b>XL</b> 1050mA Consumo de energia: 37,4W Material: alumínio / policarbonato (PC)
--	--	--

	2700K	20°	1460lm	1003841	87,00 EUR	2150lm	1003913	106,00 EUR	3300lm	1003985	132,00 EUR
		40°	1460lm	1003844	87,00 EUR	2150lm	1003916	106,00 EUR	3300lm	1003988	132,00 EUR
		55°	1460lm	1003847	87,00 EUR	2150lm	1003919	106,00 EUR	3300lm	1003991	132,00 EUR
	3000K	20°	1500lm	1003865	87,00 EUR	2150lm	1003937	106,00 EUR	3300lm	1004009	132,00 EUR
		40°	1500lm	1003868	87,00 EUR	2150lm	1003940	106,00 EUR	3300lm	1004012	132,00 EUR
		55°	1500lm	1003871	87,00 EUR	2150lm	1003943	106,00 EUR	3300lm	1004015	132,00 EUR
	4000K	20°	1600lm	1003889	87,00 EUR	2350lm	1003961	106,00 EUR	3600lm	1004033	132,00 EUR
		40°	1600lm	1003892	87,00 EUR	2350lm	1003964	106,00 EUR	3600lm	1004036	132,00 EUR
		55°	1600lm	1003895	87,00 EUR	2350lm	1003967	106,00 EUR	3600lm	1004039	132,00 EUR
	2700K	20°	1600lm	1003842	87,00 EUR	2250lm	1003914	106,00 EUR	3500lm	1003986	132,00 EUR
		40°	1600lm	1003845	87,00 EUR	2250lm	1003917	106,00 EUR	3500lm	1003989	132,00 EUR
		55°	1600lm	1003848	87,00 EUR	2250lm	1003920	106,00 EUR	3500lm	1003992	132,00 EUR
	3000K	20°	1600lm	1003866	87,00 EUR	2300lm	1003938	106,00 EUR	3550lm	1004010	132,00 EUR
		40°	1600lm	1003869	87,00 EUR	2300lm	1003941	106,00 EUR	3550lm	1004013	132,00 EUR
		55°	1600lm	1003872	87,00 EUR	2300lm	1003944	106,00 EUR	3550lm	1004016	132,00 EUR
	4000K	20°	1750lm	1003890	87,00 EUR	2450lm	1003962	106,00 EUR	3800lm	1004034	132,00 EUR
		40°	1750lm	1003893	87,00 EUR	2450lm	1003965	106,00 EUR	3800lm	1004037	132,00 EUR
		55°	1750lm	1003896	87,00 EUR	2450lm	1003968	106,00 EUR	3800lm	1004040	132,00 EUR
	2700K	20°	1550lm	1003843	87,00 EUR	2150lm	1003915	106,00 EUR	3400lm	1003987	132,00 EUR
		40°	1550lm	1003846	87,00 EUR	2150lm	1003918	106,00 EUR	3400lm	1003990	132,00 EUR
		55°	1550lm	1003849	87,00 EUR	2150lm	1003921	106,00 EUR	3400lm	1003993	132,00 EUR
	3000K	20°	1550lm	1003867	87,00 EUR	2200lm	1003939	106,00 EUR	3500lm	1004011	132,00 EUR
		40°	1550lm	1003870	87,00 EUR	2200lm	1003942	106,00 EUR	3500lm	1004014	132,00 EUR
		55°	1550lm	1003873	87,00 EUR	2200lm	1003945	106,00 EUR	3500lm	1004017	132,00 EUR
	4000K	20°	1660lm	1003891	87,00 EUR	2350lm	1003963	106,00 EUR	3750lm	1004035	132,00 EUR
		40°	1660lm	1003894	87,00 EUR	2350lm	1003966	106,00 EUR	3750lm	1004038	132,00 EUR
		55°	1660lm	1003897	87,00 EUR	2350lm	1003969	106,00 EUR	3750lm	1004041	132,00 EUR
	2700K	20°	1460lm	1003853	87,00 EUR	2150lm	1003925	106,00 EUR	3300lm	1003997	132,00 EUR
		40°	1460lm	1003856	87,00 EUR	2150lm	1003928	106,00 EUR	3300lm	1004000	132,00 EUR
		55°	1460lm	1003859	87,00 EUR	2150lm	1003931	106,00 EUR	3300lm	1004003	132,00 EUR
	3000K	20°	1500lm	1003877	87,00 EUR	2150lm	1003949	106,00 EUR	3300lm	1004021	132,00 EUR
		40°	1500lm	1003880	87,00 EUR	2150lm	1003952	106,00 EUR	3300lm	1004024	132,00 EUR
		55°	1500lm	1003883	87,00 EUR	2150lm	1003955	106,00 EUR	3300lm	1004027	132,00 EUR
	4000K	20°	1600lm	1003901	87,00 EUR	2350lm	1003973	106,00 EUR	3600lm	1004045	132,00 EUR
		40°	1600lm	1003904	87,00 EUR	2350lm	1003976	106,00 EUR	3600lm	1004048	132,00 EUR
		55°	1600lm	1003907	87,00 EUR	2350lm	1003979	106,00 EUR	3600lm	1004051	132,00 EUR
	2700K	20°	1600lm	1003854	87,00 EUR	2250lm	1003926	106,00 EUR	3500lm	1003998	132,00 EUR
		40°	1600lm	1003857	87,00 EUR	2250lm	1003929	106,00 EUR	3500lm	1004001	132,00 EUR
		55°	1600lm	1003860	87,00 EUR	2250lm	1003932	106,00 EUR	3500lm	1004004	132,00 EUR
	3000K	20°	1600lm	1003878	87,00 EUR	2300lm	1003950	106,00 EUR	3550lm	1004022	132,00 EUR
		40°	1600lm	1003881	87,00 EUR	2300lm	1003953	106,00 EUR	3550lm	1004025	132,00 EUR
		55°	1600lm	1003884	87,00 EUR	2300lm	1003956	106,00 EUR	3550lm	1004028	132,00 EUR
	4000K	20°	1750lm	1003902	87,00 EUR	2450lm	1003974	106,00 EUR	3800lm	1004046	132,00 EUR
		40°	1750lm	1003905	87,00 EUR	2450lm	1003977	106,00 EUR	3800lm	1004049	132,00 EUR
		55°	1750lm	1003908	87,00 EUR	2450lm	1003980	106,00 EUR	3800lm	1004052	132,00 EUR
	2700K	20°	1550lm	1003855	87,00 EUR	2150lm	1003927	106,00 EUR	3400lm	1003999	132,00 EUR
		40°	1550lm	1003858	87,00 EUR	2150lm	1003930	106,00 EUR	3400lm	1004002	132,00 EUR
		55°	1550lm	1003861	87,00 EUR	2150lm	1003933	106,00 EUR	3400lm	1004005	132,00 EUR
	3000K	20°	1550lm	1003879	87,00 EUR	2200lm	1003951	106,00 EUR	3500lm	1004023	132,00 EUR
		40°	1550lm	1003882	87,00 EUR	2200lm	1003954	106,00 EUR	3500lm	1004026	132,00 EUR
		55°	1550lm	1003885	87,00 EUR	2200lm	1003957	106,00 EUR	3500lm	1004029	132,00 EUR
	4000K	20°	1660lm	1003903	87,00 EUR	2350lm	1003975	106,00 EUR	3750lm	1004047	132,00 EUR
		40°	1660lm	1003906	87,00 EUR	2350lm	1003978	106,00 EUR	3750lm	1004050	132,00 EUR
		55°	1660lm	1003909	87,00 EUR	2350lm	1003981	106,00 EUR	3750lm	1004053	132,00 EUR



IP20

IK02

L80B50

355°

30°

10

Conector de tensão reduzida

**XS**

200mA  
Consumo de energia: 7W  
Material: alumínio / policarbonato (PC)

**S**

250mA  
Consumo de energia: 8,6W  
Material: alumínio / policarbonato (PC)

2700K	20°	640lm	1005553	84,00 EUR	670lm	1005319	92,00 EUR
	40°	620lm	1005556	84,00 EUR	670lm	1005322	92,00 EUR
	55°	640lm	1005559	84,00 EUR	670lm	1005325	92,00 EUR
3000K	20°	700lm	1005571	84,00 EUR	690lm	1005337	92,00 EUR
	40°	670lm	1005574	84,00 EUR	690lm	1005340	92,00 EUR
	55°	690lm	1005577	84,00 EUR	690lm	1005343	92,00 EUR
4000K	20°	720lm	1005589	84,00 EUR	730lm	1005355	92,00 EUR
	40°	700lm	1005592	84,00 EUR	730lm	1005358	92,00 EUR
	55°	710lm	1005595	84,00 EUR	730lm	1005361	92,00 EUR
2700K	20°	670lm	1005554	84,00 EUR	720lm	1005320	92,00 EUR
	40°	650lm	1005557	84,00 EUR	720lm	1005323	92,00 EUR
	55°	670lm	1005560	84,00 EUR	720lm	1005326	92,00 EUR
3000K	20°	730lm	1005572	84,00 EUR	730lm	1005338	92,00 EUR
	40°	700lm	1005575	84,00 EUR	730lm	1005341	92,00 EUR
	55°	720lm	1005578	84,00 EUR	730lm	1005344	92,00 EUR
4000K	20°	750lm	1005590	84,00 EUR	790lm	1005356	92,00 EUR
	40°	730lm	1005593	84,00 EUR	790lm	1005359	92,00 EUR
	55°	740lm	1005596	84,00 EUR	790lm	1005362	92,00 EUR
2700K	20°	670lm	1005555	84,00 EUR	690lm	1005321	92,00 EUR
	40°	650lm	1005558	84,00 EUR	690lm	1005324	92,00 EUR
	55°	670lm	1005561	84,00 EUR	690lm	1005327	92,00 EUR
3000K	20°	730lm	1005573	84,00 EUR	700lm	1005339	92,00 EUR
	40°	700lm	1005576	84,00 EUR	700lm	1005342	92,00 EUR
	55°	720lm	1005579	84,00 EUR	700lm	1005345	92,00 EUR
4000K	20°	750lm	1005591	84,00 EUR	750lm	1005357	92,00 EUR
	40°	730lm	1005594	84,00 EUR	750lm	1005360	92,00 EUR
	55°	740lm	1005597	84,00 EUR	750lm	1005363	92,00 EUR
2700K	20°	640lm	1005562	84,00 EUR	670lm	1005328	92,00 EUR
	40°	620lm	1005565	84,00 EUR	670lm	1005331	92,00 EUR
	55°	640lm	1005568	84,00 EUR	670lm	1005334	92,00 EUR
3000K	20°	700lm	1005580	84,00 EUR	690lm	1005346	92,00 EUR
	40°	670lm	1005583	84,00 EUR	690lm	1005349	92,00 EUR
	55°	690lm	1005586	84,00 EUR	690lm	1005352	92,00 EUR
4000K	20°	720lm	1005598	84,00 EUR	730lm	1005364	92,00 EUR
	40°	700lm	1005603	84,00 EUR	730lm	1005367	92,00 EUR
	55°	710lm	1005606	84,00 EUR	730lm	1005370	92,00 EUR
2700K	20°	670lm	1005563	84,00 EUR	720lm	1005329	92,00 EUR
	40°	650lm	1005566	84,00 EUR	720lm	1005332	92,00 EUR
	55°	670lm	1005569	84,00 EUR	720lm	1005335	92,00 EUR
3000K	20°	730lm	1005581	84,00 EUR	730lm	1005347	92,00 EUR
	40°	700lm	1005584	84,00 EUR	730lm	1005350	92,00 EUR
	55°	720lm	1005587	84,00 EUR	730lm	1005353	92,00 EUR
4000K	20°	750lm	1005599	84,00 EUR	790lm	1005365	92,00 EUR
	40°	730lm	1005604	84,00 EUR	790lm	1005368	92,00 EUR
	55°	740lm	1005607	84,00 EUR	790lm	1005371	92,00 EUR
2700K	20°	670lm	1005564	84,00 EUR	690lm	1005330	92,00 EUR
	40°	650lm	1005567	84,00 EUR	690lm	1005333	92,00 EUR
	55°	670lm	1005570	84,00 EUR	690lm	1005336	92,00 EUR
3000K	20°	730lm	1005582	84,00 EUR	700lm	1005348	92,00 EUR
	40°	700lm	1005585	84,00 EUR	700lm	1005351	92,00 EUR
	55°	720lm	1005588	84,00 EUR	700lm	1005354	92,00 EUR
4000K	20°	750lm	1005600	84,00 EUR	750lm	1005366	92,00 EUR
	40°	730lm	1005605	84,00 EUR	750lm	1005369	92,00 EUR
	55°	740lm	1005608	84,00 EUR	750lm	1005372	92,00 EUR



<b>M</b> 500mA Consumo de energia: 17,5W Material: alumínio / policarbonato (PC)	<b>L</b> 700mA Consumo de energia: 25,4W Material: alumínio / policarbonato (PC)	<b>XL</b> 1050mA Consumo de energia: 37,4W Material: alumínio / policarbonato (PC)
--	--	--

	2700K	20°	1460lm	1003553	102,00 EUR	2150lm	1003625	122,00 EUR	3300lm	1003697	152,00 EUR
		40°	1460lm	1003556	102,00 EUR	2150lm	1003628	122,00 EUR	3300lm	1003700	152,00 EUR
		55°	1460lm	1003559	102,00 EUR	2150lm	1003631	122,00 EUR	3300lm	1003703	152,00 EUR
	3000K	20°	1500lm	1003577	102,00 EUR	2150lm	1003649	122,00 EUR	3300lm	1003721	152,00 EUR
		40°	1500lm	1003580	102,00 EUR	2150lm	1003652	122,00 EUR	3300lm	1003724	152,00 EUR
		55°	1500lm	1003583	102,00 EUR	2150lm	1003655	122,00 EUR	3300lm	1003727	152,00 EUR
	4000K	20°	1600lm	1003601	102,00 EUR	2350lm	1003673	122,00 EUR	3600lm	1003745	152,00 EUR
		40°	1600lm	1003604	102,00 EUR	2350lm	1003676	122,00 EUR	3600lm	1003748	152,00 EUR
		55°	1600lm	1003607	102,00 EUR	2350lm	1003679	122,00 EUR	3600lm	1003751	152,00 EUR
	2700K	20°	1600lm	1003554	102,00 EUR	2250lm	1003626	122,00 EUR	3500lm	1003698	152,00 EUR
		40°	1600lm	1003557	102,00 EUR	2250lm	1003629	122,00 EUR	3500lm	1003701	152,00 EUR
		55°	1600lm	1003560	102,00 EUR	2250lm	1003632	122,00 EUR	3500lm	1003704	152,00 EUR
	3000K	20°	1600lm	1003578	102,00 EUR	2300lm	1003650	122,00 EUR	3550lm	1003722	152,00 EUR
		40°	1600lm	1003581	102,00 EUR	2300lm	1003653	122,00 EUR	3550lm	1003725	152,00 EUR
		55°	1600lm	1003584	102,00 EUR	2300lm	1003656	122,00 EUR	3550lm	1003728	152,00 EUR
	4000K	20°	1750lm	1003602	102,00 EUR	2450lm	1003674	122,00 EUR	3800lm	1003746	152,00 EUR
		40°	1750lm	1003605	102,00 EUR	2450lm	1003677	122,00 EUR	3800lm	1003749	152,00 EUR
		55°	1750lm	1003608	102,00 EUR	2450lm	1003680	122,00 EUR	3800lm	1003752	152,00 EUR
	2700K	20°	1550lm	1003555	102,00 EUR	2150lm	1003627	122,00 EUR	3400lm	1003699	152,00 EUR
		40°	1550lm	1003558	102,00 EUR	2150lm	1003630	122,00 EUR	3400lm	1003702	152,00 EUR
		55°	1550lm	1003561	102,00 EUR	2150lm	1003633	122,00 EUR	3400lm	1003705	152,00 EUR
	3000K	20°	1550lm	1003579	102,00 EUR	2200lm	1003651	122,00 EUR	3500lm	1003723	152,00 EUR
		40°	1550lm	1003582	102,00 EUR	2200lm	1003654	122,00 EUR	3500lm	1003726	152,00 EUR
		55°	1550lm	1003585	102,00 EUR	2200lm	1003657	122,00 EUR	3500lm	1003729	152,00 EUR
	4000K	20°	1660lm	1003603	102,00 EUR	2350lm	1003675	122,00 EUR	3750lm	1003747	152,00 EUR
		40°	1660lm	1003606	102,00 EUR	2350lm	1003678	122,00 EUR	3750lm	1003750	152,00 EUR
		55°	1660lm	1003609	102,00 EUR	2350lm	1003681	122,00 EUR	3750lm	1003753	152,00 EUR
	2700K	20°	1460lm	1003565	102,00 EUR	2150lm	1003637	122,00 EUR	3300lm	1003709	152,00 EUR
		40°	1460lm	1003568	102,00 EUR	2150lm	1003640	122,00 EUR	3300lm	1003712	152,00 EUR
		55°	1460lm	1003571	102,00 EUR	2150lm	1003643	122,00 EUR	3300lm	1003715	152,00 EUR
	3000K	20°	1500lm	1003589	102,00 EUR	2150lm	1003661	122,00 EUR	3300lm	1003733	152,00 EUR
		40°	1500lm	1003592	102,00 EUR	2150lm	1003664	122,00 EUR	3300lm	1003736	152,00 EUR
		55°	1500lm	1003595	102,00 EUR	2150lm	1003667	122,00 EUR	3300lm	1003739	152,00 EUR
	4000K	20°	1600lm	1003613	102,00 EUR	2350lm	1003685	122,00 EUR	3600lm	1003757	152,00 EUR
		40°	1600lm	1003616	102,00 EUR	2350lm	1003688	122,00 EUR	3600lm	1003760	152,00 EUR
		55°	1600lm	1003619	102,00 EUR	2350lm	1003691	122,00 EUR	3600lm	1003763	152,00 EUR
	2700K	20°	1600lm	1003566	102,00 EUR	2250lm	1003638	122,00 EUR	3500lm	1003710	152,00 EUR
		40°	1600lm	1003569	102,00 EUR	2250lm	1003641	122,00 EUR	3500lm	1003713	152,00 EUR
		55°	1600lm	1003572	102,00 EUR	2250lm	1003644	122,00 EUR	3500lm	1003716	152,00 EUR
	3000K	20°	1600lm	1003590	102,00 EUR	2300lm	1003662	122,00 EUR	3550lm	1003734	152,00 EUR
		40°	1600lm	1003593	102,00 EUR	2300lm	1003665	122,00 EUR	3550lm	1003737	152,00 EUR
		55°	1600lm	1003596	102,00 EUR	2300lm	1003668	122,00 EUR	3550lm	1003740	152,00 EUR
	4000K	20°	1750lm	1003614	102,00 EUR	2450lm	1003686	122,00 EUR	3800lm	1003758	152,00 EUR
		40°	1750lm	1003617	102,00 EUR	2450lm	1003689	122,00 EUR	3800lm	1003761	152,00 EUR
		55°	1750lm	1003620	102,00 EUR	2450lm	1003692	122,00 EUR	3800lm	1003764	152,00 EUR
	2700K	20°	1550lm	1003567	102,00 EUR	2150lm	1003639	122,00 EUR	3400lm	1003711	152,00 EUR
		40°	1550lm	1003570	102,00 EUR	2150lm	1003642	122,00 EUR	3400lm	1003714	152,00 EUR
		55°	1550lm	1003573	102,00 EUR	2150lm	1003645	122,00 EUR	3400lm	1003717	152,00 EUR
	3000K	20°	1550lm	1003591	102,00 EUR	2200lm	1003663	122,00 EUR	3500lm	1003735	152,00 EUR
		40°	1550lm	1003594	102,00 EUR	2200lm	1003666	122,00 EUR	3500lm	1003738	152,00 EUR
		55°	1550lm	1003597	102,00 EUR	2200lm	1003669	122,00 EUR	3500lm	1003741	152,00 EUR
	4000K	20°	1660lm	1003615	102,00 EUR	2350lm	1003687	122,00 EUR	3750lm	1003759	152,00 EUR
		40°	1660lm	1003618	102,00 EUR	2350lm	1003690	122,00 EUR	3750lm	1003762	152,00 EUR
		55°	1660lm	1003621	102,00 EUR	2350lm	1003693	122,00 EUR	3750lm	1003765	152,00 EUR

# NUMINOS® GIMBLE DL



35° 60° 10

Conector de tensão reduzida

**XS**

200mA  
Consumo de energia: 7W  
Material: alumínio / policarbonato (PC)

**S**

250mA  
Consumo de energia: 8,6W  
Material: alumínio / policarbonato (PC)

	2700K	20°	640lm	<b>1005813</b>	92,00 EUR	670lm	<b>1005867</b>	102,00 EUR
		40°	620lm	<b>1005816</b>	92,00 EUR	670lm	<b>1005870</b>	102,00 EUR
		55°	640lm	<b>1005819</b>	92,00 EUR	670lm	<b>1005873</b>	102,00 EUR
	3000K	20°	700lm	<b>1005831</b>	92,00 EUR	690lm	<b>1005885</b>	102,00 EUR
		40°	670lm	<b>1005834</b>	92,00 EUR	690lm	<b>1005888</b>	102,00 EUR
		55°	690lm	<b>1005837</b>	92,00 EUR	690lm	<b>1005891</b>	102,00 EUR
	4000K	20°	720lm	<b>1005849</b>	92,00 EUR	730lm	<b>1005903</b>	102,00 EUR
		40°	700lm	<b>1005852</b>	92,00 EUR	730lm	<b>1005906</b>	102,00 EUR
		55°	710lm	<b>1005855</b>	92,00 EUR	730lm	<b>1005909</b>	102,00 EUR
	2700K	20°	670lm	<b>1005814</b>	92,00 EUR	720lm	<b>1005868</b>	102,00 EUR
		40°	650lm	<b>1005817</b>	92,00 EUR	720lm	<b>1005871</b>	102,00 EUR
		55°	670lm	<b>1005820</b>	92,00 EUR	720lm	<b>1005874</b>	102,00 EUR
	3000K	20°	730lm	<b>1005832</b>	92,00 EUR	730lm	<b>1005886</b>	102,00 EUR
		40°	700lm	<b>1005835</b>	92,00 EUR	730lm	<b>1005889</b>	102,00 EUR
		55°	720lm	<b>1005838</b>	92,00 EUR	730lm	<b>1005892</b>	102,00 EUR
	4000K	20°	750lm	<b>1005850</b>	92,00 EUR	790lm	<b>1005904</b>	102,00 EUR
		40°	730lm	<b>1005853</b>	92,00 EUR	790lm	<b>1005907</b>	102,00 EUR
		55°	740lm	<b>1005856</b>	92,00 EUR	790lm	<b>1005910</b>	102,00 EUR
	2700K	20°	670lm	<b>1005815</b>	92,00 EUR	690lm	<b>1005869</b>	102,00 EUR
		40°	650lm	<b>1005818</b>	92,00 EUR	690lm	<b>1005872</b>	102,00 EUR
		55°	670lm	<b>1005821</b>	92,00 EUR	690lm	<b>1005875</b>	102,00 EUR
	3000K	20°	730lm	<b>1005833</b>	92,00 EUR	700lm	<b>1005887</b>	102,00 EUR
		40°	700lm	<b>1005836</b>	92,00 EUR	700lm	<b>1005890</b>	102,00 EUR
		55°	720lm	<b>1005839</b>	92,00 EUR	700lm	<b>1005893</b>	102,00 EUR
	4000K	20°	750lm	<b>1005851</b>	92,00 EUR	750lm	<b>1005905</b>	102,00 EUR
		40°	730lm	<b>1005854</b>	92,00 EUR	750lm	<b>1005908</b>	102,00 EUR
		55°	740lm	<b>1005857</b>	92,00 EUR	750lm	<b>1005911</b>	102,00 EUR
	2700K	20°	640lm	<b>1005822</b>	92,00 EUR	670lm	<b>1005876</b>	102,00 EUR
		40°	620lm	<b>1005825</b>	92,00 EUR	670lm	<b>1005879</b>	102,00 EUR
		55°	640lm	<b>1005828</b>	92,00 EUR	670lm	<b>1005882</b>	102,00 EUR
	3000K	20°	700lm	<b>1005840</b>	92,00 EUR	690lm	<b>1005894</b>	102,00 EUR
		40°	670lm	<b>1005843</b>	92,00 EUR	690lm	<b>1005897</b>	102,00 EUR
		55°	690lm	<b>1005846</b>	92,00 EUR	690lm	<b>1005900</b>	102,00 EUR
	4000K	20°	720lm	<b>1005858</b>	92,00 EUR	730lm	<b>1005912</b>	102,00 EUR
		40°	700lm	<b>1005861</b>	92,00 EUR	730lm	<b>1005915</b>	102,00 EUR
		55°	710lm	<b>1005864</b>	92,00 EUR	730lm	<b>1005918</b>	102,00 EUR
	2700K	20°	670lm	<b>1005823</b>	92,00 EUR	720lm	<b>1005877</b>	102,00 EUR
		40°	650lm	<b>1005826</b>	92,00 EUR	720lm	<b>1005880</b>	102,00 EUR
		55°	670lm	<b>1005829</b>	92,00 EUR	720lm	<b>1005883</b>	102,00 EUR
	3000K	20°	730lm	<b>1005841</b>	92,00 EUR	730lm	<b>1005895</b>	102,00 EUR
		40°	700lm	<b>1005844</b>	92,00 EUR	730lm	<b>1005898</b>	102,00 EUR
		55°	720lm	<b>1005847</b>	92,00 EUR	730lm	<b>1005901</b>	102,00 EUR
	4000K	20°	750lm	<b>1005859</b>	92,00 EUR	790lm	<b>1005913</b>	102,00 EUR
		40°	730lm	<b>1005862</b>	92,00 EUR	790lm	<b>1005916</b>	102,00 EUR
		55°	740lm	<b>1005865</b>	92,00 EUR	790lm	<b>1005919</b>	102,00 EUR
	2700K	20°	670lm	<b>1005824</b>	92,00 EUR	690lm	<b>1005878</b>	102,00 EUR
		40°	650lm	<b>1005827</b>	92,00 EUR	690lm	<b>1005881</b>	102,00 EUR
		55°	670lm	<b>1005830</b>	92,00 EUR	690lm	<b>1005884</b>	102,00 EUR
	3000K	20°	730lm	<b>1005842</b>	92,00 EUR	700lm	<b>1005896</b>	102,00 EUR
		40°	700lm	<b>1005845</b>	92,00 EUR	700lm	<b>1005899</b>	102,00 EUR
		55°	720lm	<b>1005848</b>	92,00 EUR	700lm	<b>1005902</b>	102,00 EUR
	4000K	20°	750lm	<b>1005860</b>	92,00 EUR	750lm	<b>1005914</b>	102,00 EUR
		40°	730lm	<b>1005863</b>	92,00 EUR	750lm	<b>1005917</b>	102,00 EUR
		55°	740lm	<b>1005866</b>	92,00 EUR	750lm	<b>1005920</b>	102,00 EUR





<p><b>M</b> 500mA Consumo de energia: 17,5W Material: alumínio / policarbonato (PC)</p>	<p><b>L</b> 700mA Consumo de energia: 25,4W Material: alumínio / policarbonato (PC)</p>	<p><b>XL</b> 1000 / 1050mA Consumo de energia: 37,4W Material: alumínio / policarbonato (PC)</p>
---	---	--

	2700K	20°	1460lm	1005921	112,00 EUR	2150lm	1005975	132,00 EUR	3300lm	1006029	155,00 EUR
		40°	1460lm	1005924	112,00 EUR	2150lm	1005978	132,00 EUR	3300lm	1006032	155,00 EUR
		55°	1460lm	1005927	112,00 EUR	2150lm	1005981	132,00 EUR	3300lm	1006035	155,00 EUR
	3000K	20°	1500lm	1005939	112,00 EUR	2150lm	1005993	132,00 EUR	3300lm	1006047	155,00 EUR
		40°	1500lm	1005942	112,00 EUR	2150lm	1005996	132,00 EUR	3300lm	1006050	155,00 EUR
		55°	1500lm	1005945	112,00 EUR	2150lm	1005999	132,00 EUR	3300lm	1006053	155,00 EUR
	4000K	20°	1600lm	1005957	112,00 EUR	2350lm	1006011	132,00 EUR	3600lm	1006065	155,00 EUR
		40°	1600lm	1005960	112,00 EUR	2350lm	1006014	132,00 EUR	3600lm	1006068	155,00 EUR
		55°	1600lm	1005963	112,00 EUR	2350lm	1006017	132,00 EUR	3600lm	1006071	155,00 EUR
	2700K	20°	1600lm	1005922	112,00 EUR	2250lm	1005976	132,00 EUR	3500lm	1006030	155,00 EUR
		40°	1600lm	1005925	112,00 EUR	2250lm	1005979	132,00 EUR	3500lm	1006033	155,00 EUR
		55°	1600lm	1005928	112,00 EUR	2250lm	1005982	132,00 EUR	3500lm	1006036	155,00 EUR
	3000K	20°	1600lm	1005940	112,00 EUR	2300lm	1005994	132,00 EUR	3550lm	1006048	155,00 EUR
		40°	1600lm	1005943	112,00 EUR	2300lm	1005997	132,00 EUR	3550lm	1006051	155,00 EUR
		55°	1600lm	1005946	112,00 EUR	2300lm	1006000	132,00 EUR	3550lm	1006054	155,00 EUR
	4000K	20°	1750lm	1005958	112,00 EUR	2450lm	1006012	132,00 EUR	3800lm	1006066	155,00 EUR
		40°	1750lm	1005961	112,00 EUR	2450lm	1006015	132,00 EUR	3800lm	1006069	155,00 EUR
		55°	1750lm	1005964	112,00 EUR	2450lm	1006018	132,00 EUR	3800lm	1006072	155,00 EUR
	2700K	20°	1550lm	1005923	112,00 EUR	2150lm	1005977	132,00 EUR	3400lm	1006031	155,00 EUR
		40°	1550lm	1005926	112,00 EUR	2150lm	1005980	132,00 EUR	3400lm	1006034	155,00 EUR
		55°	1550lm	1005929	112,00 EUR	2150lm	1005983	132,00 EUR	3400lm	1006037	155,00 EUR
	3000K	20°	1550lm	1005941	112,00 EUR	2200lm	1005995	132,00 EUR	3500lm	1006049	155,00 EUR
		40°	1550lm	1005944	112,00 EUR	2200lm	1005998	132,00 EUR	3500lm	1006052	155,00 EUR
		55°	1550lm	1005947	112,00 EUR	2200lm	1006001	132,00 EUR	3500lm	1006055	155,00 EUR
	4000K	20°	1660lm	1005959	112,00 EUR	2350lm	1006013	132,00 EUR	3750lm	1006067	155,00 EUR
		40°	1660lm	1005962	112,00 EUR	2350lm	1006016	132,00 EUR	3750lm	1006070	155,00 EUR
		55°	1660lm	1005965	112,00 EUR	2350lm	1006019	132,00 EUR	3750lm	1006073	155,00 EUR
	2700K	20°	1460lm	1005930	112,00 EUR	2150lm	1005984	132,00 EUR	3300lm	1006038	155,00 EUR
		40°	1460lm	1005933	112,00 EUR	2150lm	1005987	132,00 EUR	3300lm	1006041	155,00 EUR
		55°	1460lm	1005936	112,00 EUR	2150lm	1005990	132,00 EUR	3300lm	1006044	155,00 EUR
	3000K	20°	1500lm	1005948	112,00 EUR	2150lm	1006002	132,00 EUR	3300lm	1006056	155,00 EUR
		40°	1500lm	1005951	112,00 EUR	2150lm	1006005	132,00 EUR	3300lm	1006059	155,00 EUR
		55°	1500lm	1005954	112,00 EUR	2150lm	1006008	132,00 EUR	3300lm	1006062	155,00 EUR
	4000K	20°	1600lm	1005966	112,00 EUR	2350lm	1006020	132,00 EUR	3600lm	1006074	155,00 EUR
		40°	1600lm	1005969	112,00 EUR	2350lm	1006023	132,00 EUR	3600lm	1006077	155,00 EUR
		55°	1600lm	1005972	112,00 EUR	2350lm	1006026	132,00 EUR	3600lm	1006080	155,00 EUR
	2700K	20°	1600lm	1005931	112,00 EUR	2250lm	1005985	132,00 EUR	3500lm	1006039	155,00 EUR
		40°	1600lm	1005934	112,00 EUR	2250lm	1005988	132,00 EUR	3500lm	1006042	155,00 EUR
		55°	1600lm	1005937	112,00 EUR	2250lm	1005991	132,00 EUR	3500lm	1006045	155,00 EUR
	3000K	20°	1600lm	1005949	112,00 EUR	2300lm	1006003	132,00 EUR	3550lm	1006057	155,00 EUR
		40°	1600lm	1005952	112,00 EUR	2300lm	1006006	132,00 EUR	3550lm	1006060	155,00 EUR
		55°	1600lm	1005955	112,00 EUR	2300lm	1006009	132,00 EUR	3550lm	1006063	155,00 EUR
	4000K	20°	1750lm	1005967	112,00 EUR	2450lm	1006021	132,00 EUR	3800lm	1006075	155,00 EUR
		40°	1750lm	1005970	112,00 EUR	2450lm	1006024	132,00 EUR	3800lm	1006078	155,00 EUR
		55°	1750lm	1005973	112,00 EUR	2450lm	1006027	132,00 EUR	3800lm	1006081	155,00 EUR
	2700K	20°	1550lm	1005932	112,00 EUR	2150lm	1005986	132,00 EUR	3400lm	1006040	155,00 EUR
		40°	1550lm	1005935	112,00 EUR	2150lm	1005989	132,00 EUR	3400lm	1006043	155,00 EUR
		55°	1550lm	1005938	112,00 EUR	2150lm	1005992	132,00 EUR	3400lm	1006046	155,00 EUR
	3000K	20°	1550lm	1005950	112,00 EUR	2200lm	1006004	132,00 EUR	3500lm	1006058	155,00 EUR
		40°	1550lm	1005953	112,00 EUR	2200lm	1006007	132,00 EUR	3500lm	1006061	155,00 EUR
		55°	1550lm	1005956	112,00 EUR	2200lm	1006010	132,00 EUR	3500lm	1006064	155,00 EUR
	4000K	20°	1660lm	1005968	112,00 EUR	2350lm	1006022	132,00 EUR	3750lm	1006076	155,00 EUR
		40°	1660lm	1005971	112,00 EUR	2350lm	1006025	132,00 EUR	3750lm	1006079	155,00 EUR
		55°	1660lm	1005974	112,00 EUR	2350lm	1006028	132,00 EUR	3750lm	1006082	155,00 EUR

NUMINOS® PROJECTOR  
1006978

---





# NUMINOS® PROJECTOR Downlight (DL)



A aplicação do projetor  
NUMINOS® pode ser  
seleccionada individualmente



Pode encontrar mais detalhes sobre as medidas e informações de montagem nas páginas 118 e 119  
Driver não incluído. Encontra o controlador (driver) e os difusores adequados nas páginas 94 e 95.

# NUMINOS® PROJECTOR DL Move



L80B50

330°

90°

10

NEW











Conector de tensão reduzida

XS

200mA  
Consumo de energia: 7 W  
Material: alumínio

S

250mA  
Consumo de energia: 8,6W  
Material: alumínio











	2700K	20°	640lm	1006867	130,00 EUR	670lm	1006921	140,00 EUR
		40°	620lm	1006870	130,00 EUR	670lm	1006924	140,00 EUR
		55°	640lm	1006873	130,00 EUR	670lm	1006927	140,00 EUR
	3000K	20°	700lm	1006885	130,00 EUR	690lm	1006939	140,00 EUR
		40°	670lm	1006888	130,00 EUR	690lm	1006942	140,00 EUR
		55°	690lm	1006891	130,00 EUR	690lm	1006945	140,00 EUR
	2700K	20°	730lm	1006868	130,00 EUR	730lm	1006922	140,00 EUR
		40°	700lm	1006871	130,00 EUR	730lm	1006925	140,00 EUR
		55°	720lm	1006874	130,00 EUR	730lm	1006928	140,00 EUR
	3000K	20°	670lm	1006886	130,00 EUR	690lm	1006940	140,00 EUR
		40°	650lm	1006889	130,00 EUR	690lm	1006943	140,00 EUR
		55°	670lm	1006892	130,00 EUR	690lm	1006946	140,00 EUR
	2700K	20°	670lm	1006869	130,00 EUR	720lm	1006923	140,00 EUR
		40°	650lm	1006872	130,00 EUR	720lm	1006926	140,00 EUR
		55°	670lm	1006875	130,00 EUR	720lm	1006929	140,00 EUR
	3000K	20°	730lm	1006887	130,00 EUR	730lm	1006941	140,00 EUR
		40°	700lm	1006890	130,00 EUR	730lm	1006944	140,00 EUR
		55°	720lm	1006893	130,00 EUR	730lm	1006947	140,00 EUR
	2700K	20°	700lm	1006876	130,00 EUR	690lm	1006930	140,00 EUR
		40°	670lm	1006879	130,00 EUR	690lm	1006933	140,00 EUR
		55°	690lm	1006882	130,00 EUR	690lm	1006936	140,00 EUR
	3000K	20°	670lm	1006894	130,00 EUR	690lm	1006948	140,00 EUR
		40°	650lm	1006897	130,00 EUR	690lm	1006951	140,00 EUR
		55°	670lm	1006900	130,00 EUR	690lm	1006954	140,00 EUR
	2700K	20°	670lm	1006877	130,00 EUR	720lm	1006931	140,00 EUR
		40°	650lm	1006880	130,00 EUR	720lm	1006934	140,00 EUR
		55°	670lm	1006883	130,00 EUR	720lm	1006937	140,00 EUR
	3000K	20°	730lm	1006895	130,00 EUR	730lm	1006949	140,00 EUR
		40°	700lm	1006898	130,00 EUR	730lm	1006952	140,00 EUR
		55°	720lm	1006901	130,00 EUR	730lm	1006955	140,00 EUR
	2700K	20°	670lm	1006878	130,00 EUR	690lm	1006932	140,00 EUR
		40°	650lm	1006881	130,00 EUR	690lm	1006935	140,00 EUR
		55°	670lm	1006884	130,00 EUR	690lm	1006938	140,00 EUR
	3000K	20°	730lm	1006896	130,00 EUR	700lm	1006950	140,00 EUR
		40°	700lm	1006899	130,00 EUR	700lm	1006953	140,00 EUR
		55°	720lm	1006902	130,00 EUR	700lm	1006956	140,00 EUR

Estas luminárias também estão disponíveis em 4000K, mediante pedido (exceto XS).  
Observe os diferentes prazos de entrega e quantidades mínimas para encomenda.



**M** 500mA  
Consumo de energia: 17,5W  
Material: alumínio

**L** 700mA  
Consumo de energia: 25,4W  
Material: alumínio

	2700K	20°	1460lm	1006975	150,00 EUR	2150lm	1007029	160,00 EUR
		40°	1460lm	1006978	150,00 EUR	2150lm	1007032	160,00 EUR
		55°	1460lm	1006981	150,00 EUR	2150lm	1007035	160,00 EUR
	3000K	20°	1500lm	1006993	150,00 EUR	2150lm	1007047	160,00 EUR
		40°	1500lm	1006996	150,00 EUR	2150lm	1007050	160,00 EUR
		55°	1500lm	1006999	150,00 EUR	2150lm	1007053	160,00 EUR
	2700K	20°	1600lm	1006976	150,00 EUR	2300lm	1007030	160,00 EUR
		40°	1600lm	1006979	150,00 EUR	2300lm	1007033	160,00 EUR
		55°	1600lm	1006982	150,00 EUR	2300lm	1007036	160,00 EUR
	3000K	20°	1550lm	1006994	150,00 EUR	2150lm	1007048	160,00 EUR
		40°	1550lm	1006997	150,00 EUR	2150lm	1007051	160,00 EUR
		55°	1550lm	1007000	150,00 EUR	2150lm	1007054	160,00 EUR
	2700K	20°	1600lm	1006977	150,00 EUR	2250lm	1007031	160,00 EUR
		40°	1600lm	1006980	150,00 EUR	2250lm	1007034	160,00 EUR
		55°	1600lm	1006983	150,00 EUR	2250lm	1007037	160,00 EUR
	3000K	20°	1600lm	1006995	150,00 EUR	2300lm	1007049	160,00 EUR
		40°	1600lm	1006998	150,00 EUR	2300lm	1007052	160,00 EUR
		55°	1600lm	1007001	150,00 EUR	2300lm	1007055	160,00 EUR
	2700K	20°	1500lm	1006984	150,00 EUR	2150lm	1007038	160,00 EUR
		40°	1500lm	1006987	150,00 EUR	2150lm	1007041	160,00 EUR
		55°	1500lm	1006990	150,00 EUR	2150lm	1007044	160,00 EUR
	3000K	20°	1550lm	1007002	150,00 EUR	2150lm	1007056	160,00 EUR
		40°	1550lm	1007005	150,00 EUR	2150lm	1007059	160,00 EUR
		55°	1550lm	1007008	150,00 EUR	2150lm	1007062	160,00 EUR
	2700K	20°	1600lm	1006985	150,00 EUR	2250lm	1007039	160,00 EUR
		40°	1600lm	1006988	150,00 EUR	2250lm	1007042	160,00 EUR
		55°	1600lm	1006991	150,00 EUR	2250lm	1007045	160,00 EUR
	3000K	20°	1600lm	1007003	150,00 EUR	2300lm	1007057	160,00 EUR
		40°	1600lm	1007006	150,00 EUR	2300lm	1007060	160,00 EUR
		55°	1600lm	1007009	150,00 EUR	2300lm	1007063	160,00 EUR
	2700K	20°	1550lm	1006986	150,00 EUR	2150lm	1007040	160,00 EUR
		40°	1550lm	1006989	150,00 EUR	2150lm	1007043	160,00 EUR
		55°	1550lm	1006992	150,00 EUR	2150lm	1007046	160,00 EUR
	3000K	20°	1550lm	1007004	150,00 EUR	2200lm	1007058	160,00 EUR
		40°	1550lm	1007007	150,00 EUR	2200lm	1007061	160,00 EUR
		55°	1550lm	1007010	150,00 EUR	2200lm	1007064	160,00 EUR

Estas luminárias também estão disponíveis em 4000 K, mediante pedido (exceto XS).  
Observe os diferentes prazos de entrega e quantidades mínimas para encomenda.

## DRIVER ADEQUADO

XS S M L XL



Driver 200mA, 10W QC	Branco	5,8W / 8,4W	-	IP20	C: 6,5 cm, L: 3,9 cm, A: 3,5 cm	<b>1005610</b>	<b>26,00 EUR</b>
Driver 200mA, 10W, PHASE QC	Branco	6W / 8,4W	PHASE C		C: 8,5 cm, L: 4,1 cm, A: 3 cm	<b>1005609</b>	<b>35,75 EUR</b>
Controlador LED 200mA, 10W, DALI QC	Branco	3,8W / 13,5W	DALI		C: 18 cm, L: 4,5 cm, A: 3 cm	<b>1005611</b>	<b>96,00 EUR</b>
Driver 200mA, 12W, DALI + RF Interface QC	Branco	1,5W / 12W	DALI + RF		C: 14,2 cm, L: 4,4 cm, A: 3 cm	<b>1006457</b>	<b>90,00 EUR</b>
Controlador LED 250mA, 10W	Branco	6,5W / 10W	-	IP20	C: 6,5 cm, L: 3,9 cm, A: 2 cm	<b>1004058</b>	<b>26,00 EUR</b>
Driver 250mA, 10W, PHASE	Branco	7,5W / 10W	PHASE C		C: 8,5 cm, L: 3,9 cm, A: 3 cm	<b>1004055</b>	<b>40,75 EUR</b>
Driver 250mA, 20W, DALI	Branco	1,5W / 15W	DALI		C: 15 cm, L: 5,2 cm, A: 2,8 cm	<b>1004067</b>	<b>82,00 EUR</b>
Driver 250mA, 12W, DALI + RF Interface QC	Branco	1,5W / 12W	DALI + RF		C: 14,2 cm, L: 4,4 cm, A: 3 cm	<b>1006458</b>	<b>90,00 EUR</b>
Driver 500mA, 30W	Branco	15W / 29,5W	-	IP20	C: 14,7 cm, L: 4,3 cm, A: 3 cm	<b>1004064</b>	<b>30,75 EUR</b>
Driver 500mA, 30W, PHASE	Branco	12,5W / 21W	PHASE C		C: 11,5 cm, L: 4,1 cm, A: 2,5 cm	<b>1004054</b>	<b>59,00 EUR</b>
Driver 500mA, 40W, DALI	Branco	1,5W / 40,6W	DALI		C: 12,3 cm, L: 7,9 cm, A: 2,4 cm	<b>1004069</b>	<b>82,00 EUR</b>
Driver 500mA, 42W, DALI + RF Interface QC	Branco	3,5W / 42W	DALI + RF		C: 12,3 cm, L: 7,9 cm, A: 3 cm	<b>1006459</b>	<b>105,00 EUR</b>
Driver 700mA, 30W	Branco	15W / 29,5W	-	IP20	C: 14,7 cm, L: 4,3 cm, A: 3 cm	<b>1004062</b>	<b>32,00 EUR</b>
Driver 700mA, 30W, PHASE	Branco	21W / 29,4W	PHASE C		C: 11,5 cm, L: 4,4 cm, A: 3 cm	<b>1004065</b>	<b>59,00 EUR</b>
Driver 700mA, 40W, DALI	Branco	1,5W / 40,6W	DALI		C: 12,3 cm, L: 7,9 cm, A: 2,4 cm	<b>1004070</b>	<b>82,00 EUR</b>
Driver 700mA, 42W, DALI + RF Interface QC	Branco	3,5W / 42W	DALI + RF		C: 12,3 cm, L: 7,9 cm, A: 3 cm	<b>1006460</b>	<b>105,00 EUR</b>
Driver 1050mA, 40W	Branco	24W / 44W	-	IP20	C: 9,7 cm, L: 4,3 cm, A: 3 cm	<b>1004059</b>	<b>34,00 EUR</b>
Driver 1000mA, 40W, PHASE	Branco	26,3W / 42W	PHASE C		C: 14,5 cm, L: 4 cm, A: 3 cm	<b>1004066</b>	<b>63,00 EUR</b>
Driver 1050mA, 50W, DALI	Branco	4,2W / 50W	DALI		C: 12,3 cm, L: 7,9 cm, A: 2,4 cm	<b>1004071</b>	<b>82,00 EUR</b>



Uma luminária para encastrar no teto antiga, muitas vezes ainda equipada com fontes de luz convencionais, deve dar lugar a uma alternativa com melhor eficiência energética e um bom custo-benefício. Quando removemos a luminária antiga, geralmente obteremos um corte de encastramentomAior do que o que o que o que agora necessitamos.

A SLV disponibiliza a solução adequada: os anéis redutores cobrem completamente o recortemAior do teto e, ao mesmo tempo, dão à sua nova e compacta luminária uma fixação perfeita. Os nossos anéis redutores são perfeitamente compatíveis com a família NUMINOS® Downlight e Spotlight.



## DIFUSORES E ANÉIS REDUTORES

XS S M L XL



Difusor NUMINOS® XS	Elipse	IP20	Ø: 3,2 cm, A: 0,2 cm	1005612	4,50 EUR
	Prisma			1005613	5,30 EUR
	Fosco			1005614	5,30 EUR
	Alveolar			1005615	8,35 EUR
Difusor NUMINOS® S	Elipse	IP20	Ø: 4 cm, A: 0,2 cm	1004786	4,50 EUR
	Prisma			1004787	5,30 EUR
	Fosco			1004788	5,30 EUR
	Alveolar			1004789	8,35 EUR
Difusor NUMINOS® M	Elipse	IP20	Ø: 4,75 cm, A: 0,2 cm	1004790	4,50 EUR
	Prisma			1004791	5,80 EUR
	Fosco			1004792	5,80 EUR
	Alveolar			1004793	12,60 EUR
Difusor NUMINOS® L	Elipse	IP20	Ø: 5,65 cm, A: 0,2 cm	1004794	5,80 EUR
	Prisma			1004795	6,45 EUR
	Fosco			1004796	6,45 EUR
	Alveolar			1004797	16,40 EUR
Difusor NUMINOS® XL	Elipse	IP20	Ø: 7,1 cm, A: 0,2 cm	1004798	6,45 EUR
	Prisma			1004799	7,10 EUR
	Fosco			1004800	7,10 EUR
	Alveolar			1004801	21,50 EUR



Anel redutor Redondo	Preto	Recorte do teto: 8,5-13 cm	Ø exterior: 16 cm, Ø interior: 7 cm A: 5,3 cm	1006135	18,00 EUR
				Branco	
	Preto	Recorte do teto: 12-15 cm	Ø exterior: 16 cm, Ø interior: 9 cm A: 5,3 cm	1006139	15,50 EUR
				Branco	
	Preto	Recorte do teto: 14-18 cm	Ø exterior: 24 cm, Ø interior: 12 cm A: 5,3 cm	1006143	19,20 EUR
				Branco	
	Preto	Recorte do teto: 17-20 cm	Ø exterior: 24 cm, Ø interior: 15 cm A: 5,3 cm	1006147	18,00 EUR
				Branco	
	Preto	Recorte do teto: 20-22 cm	Ø exterior: 24 cm, Ø interior: 18 cm A: 5,3 cm	1006151	16,70 EUR
				Branco	
Anel redutor Quadrado	Preto	Recorte do teto: 8,5-13 cm	Ø interior: 7 cm C: 16 cm, L: 16 cm, A: 5,3 cm	1006137	18,00 EUR
				Branco	
	Preto	Recorte do teto: 12-15 cm	Ø interior: 9 cm C: 16 cm, L: 16 cm, A: 5,3 cm	1006141	15,50 EUR
				Branco	
	Preto	Recorte do teto: 14-18 cm	Ø interior: 12 cm C: 24 cm, L: 24 cm, A: 5,3 cm	1006145	19,20 EUR
				Branco	
	Preto	Recorte do teto: 17-20 cm	Ø interior: 15 cm C: 24 cm, L: 24 cm, A: 5,3 cm	1006149	18,00 EUR
				Branco	
	Preto	Recorte do teto: 20-22 cm	Ø interior: 18 cm C: 24 cm, L: 24 cm, A: 5,3 cm	1006153	16,70 EUR
				Branco	

# NUMINOS®

# PROJECTOR

---

O que escolher para o seu projetor NUMINOS®:  
pode escolher entre seis variantes de cores, quatro dimensões com diferentes potências totais, duas temperaturas de cor e três ângulos de meio-feixe de 20°, 44° e 55°.

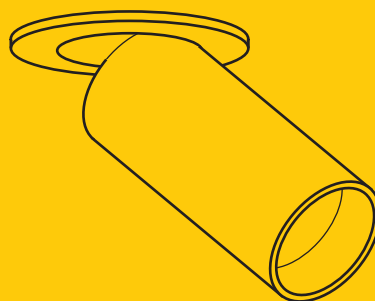
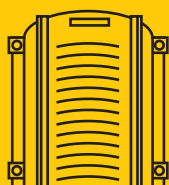
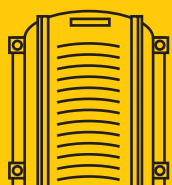

---

NUMINOS® é um sistema de iluminação perfeitamente coordenado que combina função, design e tecnologia. Para projetistas e executantes. Para todos os requisitos. Para máxima diversidade com o mínimo de esforço.



Descubra a variedade  
da série NUMINOS®  
em [slv.com](http://slv.com)



O novo NUMINOS® com um alcance da rotação e articulação muito elevado é um bom complemento para as Downlights NUMINOS®, que têm as mesmas possibilidades decorativas e óticas.

---

Disponível em quatro dimensões com módulo LED de alta performance e em duas temperaturas de cor.

Os controladores LED (drivers) estão disponíveis em separado.

---

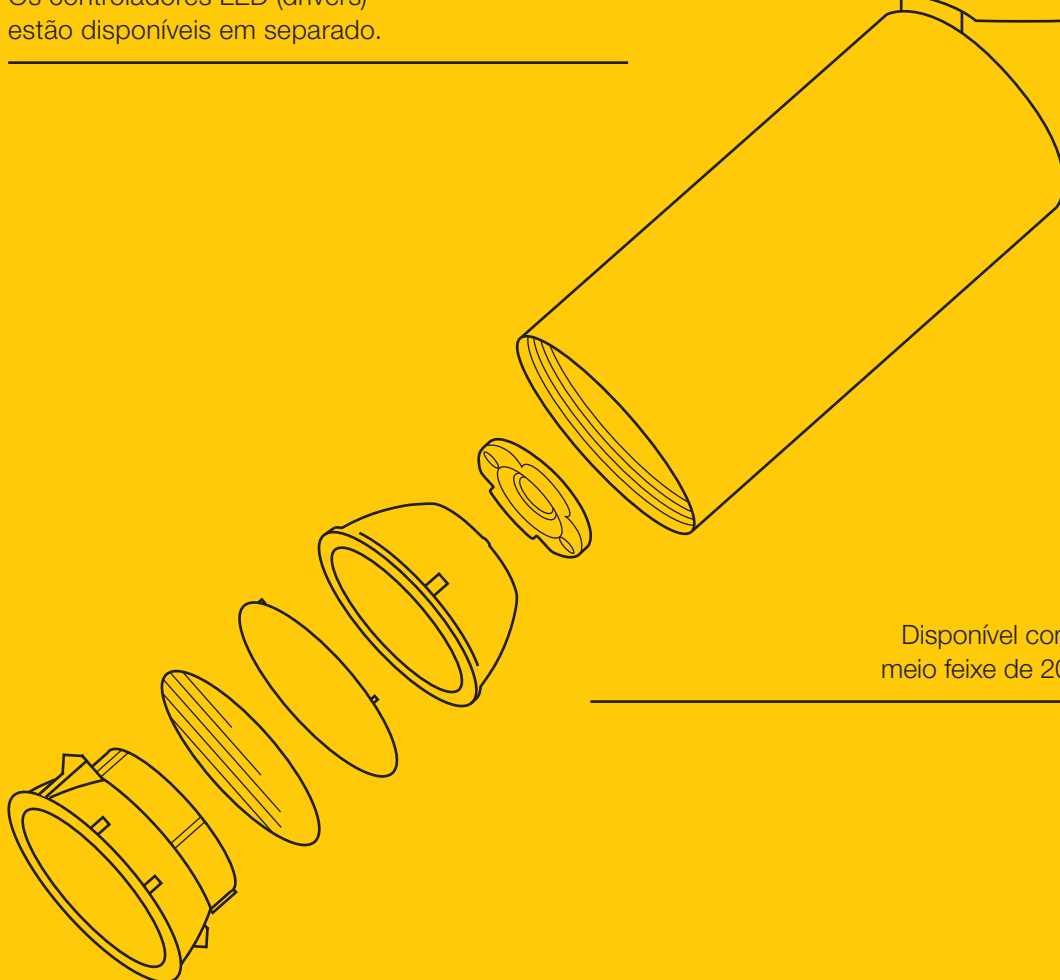
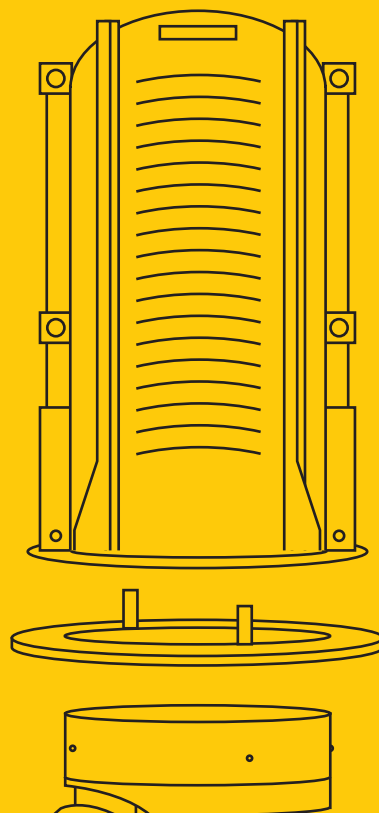

Disponível com ângulos de meio feixe de 20° | 40° | 55°.

---

NUMINOS® CW  
1004587

CLUB LOUNGE 1

TIVOLI



NUMINOS®  
Luminárias de teto e de parede  
(CW)







NUMINOS® CW  
350° de rotação  
e 90° de inclinação



  
O tamanho S também  
pode ser utilizado  
como luminária  
de parede

Anel decorativo  
também disponível  
em branco







Anel decorativo NUMINOS® S	Ø: 6,2 cm, A: 2 cm		1006167	1,30 EUR
Anel decorativo NUMINOS® M	Ø: 8,2 cm, A: 2,4 cm		1006168	2,40 EUR
Anel decorativo NUMINOS® L	Ø: 9,65 cm, A: 2,5 cm		1006169	2,40 EUR
Anel decorativo NUMINOS® XL	Ø: 11,66 cm, A: 2,85 cm		1006170	3,55 EUR



**S** 220-240V ~50/60Hz | 250mA  
Potência total: 11W  
Material: alumínio / policarbonato (PC)





**M** 220-240V ~50/60Hz | 500mA  
Potência total: 20W  
Material: alumínio / policarbonato (PC)

	2700K	24°	985lm	1004098	115,00 EUR	1925lm	1004194	145,00 EUR
		36°	985lm	1004099	115,00 EUR	1935lm	1004195	145,00 EUR
		60°	980lm	1004100	115,00 EUR	1885lm	1004196	145,00 EUR
	3000K	24°	1020lm	1004106	115,00 EUR	1955lm	1004202	145,00 EUR
		36°	1020lm	1004107	115,00 EUR	1970lm	1004203	145,00 EUR
		60°	1020lm	1004108	115,00 EUR	1880lm	1004204	145,00 EUR
	4000K	24°	1100lm	1004114	115,00 EUR	2125lm	1004210	145,00 EUR
		36°	1100lm	1004115	115,00 EUR	2120lm	1004211	145,00 EUR
		60°	1100lm	1004116	115,00 EUR	2060lm	1004212	145,00 EUR
	2700K	24°	985lm	1004386	165,00 EUR	1925lm	1004482	197,00 EUR
		36°	985lm	1004387	165,00 EUR	1935lm	1004483	197,00 EUR
		60°	980lm	1004388	165,00 EUR	1885lm	1004484	197,00 EUR
	3000K	24°	1020lm	1004394	165,00 EUR	1955lm	1004490	197,00 EUR
		36°	1020lm	1004395	165,00 EUR	1970lm	1004491	197,00 EUR
		60°	1020lm	1004396	165,00 EUR	1880lm	1004492	197,00 EUR
	4000K	24°	1100lm	1004402	165,00 EUR	2125lm	1004498	197,00 EUR
		36°	1100lm	1004403	165,00 EUR	2120lm	1004499	197,00 EUR
		60°	1100lm	1004404	165,00 EUR	2060lm	1004500	197,00 EUR
	2700K	24°	985lm	1004102	115,00 EUR	1925lm	1004198	145,00 EUR
		36°	985lm	1004103	115,00 EUR	1935lm	1004199	145,00 EUR
		60°	980lm	1004104	115,00 EUR	1885lm	1004200	145,00 EUR
	3000K	24°	1020lm	1004110	115,00 EUR	1955lm	1004206	145,00 EUR
		36°	1020lm	1004111	115,00 EUR	1970lm	1004207	145,00 EUR
		60°	1020lm	1004112	115,00 EUR	1880lm	1004208	145,00 EUR
	4000K	24°	1100lm	1004118	115,00 EUR	2125lm	1004214	145,00 EUR
		36°	1100lm	1004119	115,00 EUR	2120lm	1004215	145,00 EUR
		60°	1100lm	1004120	115,00 EUR	2060lm	1004216	145,00 EUR
	2700K	24°	985lm	1004390	165,00 EUR	1925lm	1004486	197,00 EUR
		36°	985lm	1004391	165,00 EUR	1935lm	1004487	197,00 EUR
		60°	980lm	1004392	165,00 EUR	1885lm	1004488	197,00 EUR
	3000K	24°	1020lm	1004398	165,00 EUR	1955lm	1004494	197,00 EUR
		36°	1020lm	1004399	165,00 EUR	1970lm	1004495	197,00 EUR
		60°	1020lm	1004400	165,00 EUR	1880lm	1004496	197,00 EUR
	4000K	24°	1100lm	1004406	165,00 EUR	2125lm	1004502	197,00 EUR
		36°	1100lm	1004407	165,00 EUR	2120lm	1004503	197,00 EUR
		60°	1100lm	1004408	165,00 EUR	2060lm	1004504	197,00 EUR



**L** 220-240V ~50/60Hz | 700mA  
 Potência total: 28W  
 Material: alumínio / policarbonato (PC)

**XL** 220-240V ~50/60Hz | 900mA  
 Potência total: 36W  
 Material: alumínio / policarbonato (PC)

	2700K	24°	2440lm	1004290	155,00 EUR	3290lm	1006083	165,00 EUR
		36°	2400lm	1004291	155,00 EUR	3250lm	1006084	165,00 EUR
		60°	2475lm	1004292	155,00 EUR	2980lm	1006085	165,00 EUR
	3000K	24°	2430lm	1004298	155,00 EUR	3530lm	1006089	165,00 EUR
		36°	2340lm	1004299	155,00 EUR	3490lm	1006090	165,00 EUR
		60°	2400lm	1004300	155,00 EUR	3210lm	1006091	165,00 EUR
	4000K	24°	2675lm	1004306	155,00 EUR	3800lm	1006095	165,00 EUR
		36°	2620lm	1004307	155,00 EUR	3760lm	1006096	165,00 EUR
		60°	2715lm	1004308	155,00 EUR	3460lm	1006097	165,00 EUR
	2700K	24°	2440lm	1004578	215,00 EUR	3290lm	1005741	235,00 EUR
		36°	2400lm	1004579	215,00 EUR	3250lm	1005742	235,00 EUR
		60°	2475lm	1004580	215,00 EUR	2980lm	1005743	235,00 EUR
	3000K	24°	2430lm	1004586	215,00 EUR	3530lm	1005747	235,00 EUR
		36°	2340lm	1004587	215,00 EUR	3490lm	1005748	235,00 EUR
		60°	2400lm	1004588	215,00 EUR	3210lm	1005749	235,00 EUR
	4000K	24°	2675lm	1004594	215,00 EUR	3800lm	1005753	235,00 EUR
		36°	2620lm	1004595	215,00 EUR	3760lm	1005754	235,00 EUR
		60°	2715lm	1004596	215,00 EUR	3460lm	1005755	235,00 EUR
	2700K	24°	2440lm	1004294	155,00 EUR	3290lm	1006086	165,00 EUR
		36°	2400lm	1004295	155,00 EUR	3250lm	1006087	165,00 EUR
		60°	2475lm	1004296	155,00 EUR	2980lm	1006088	165,00 EUR
	3000K	24°	2430lm	1004302	155,00 EUR	3530lm	1006092	165,00 EUR
		36°	2340lm	1004303	155,00 EUR	3490lm	1006093	165,00 EUR
		60°	2400lm	1004304	155,00 EUR	3210lm	1006094	165,00 EUR
	4000K	24°	2675lm	1004310	155,00 EUR	3800lm	1006098	165,00 EUR
		36°	2620lm	1004311	155,00 EUR	3760lm	1006099	165,00 EUR
		60°	2715lm	1004312	155,00 EUR	3460lm	1006100	165,00 EUR
	2700K	24°	2440lm	1004582	215,00 EUR	3290lm	1005744	235,00 EUR
		36°	2400lm	1004583	215,00 EUR	3250lm	1005745	235,00 EUR
		60°	2475lm	1004584	215,00 EUR	2980lm	1005746	235,00 EUR
	3000K	24°	2430lm	1004590	215,00 EUR	3530lm	1005750	235,00 EUR
		36°	2340lm	1004591	215,00 EUR	3490lm	1005751	235,00 EUR
		60°	2400lm	1004592	215,00 EUR	3210lm	1005752	235,00 EUR
	4000K	24°	2675lm	1004598	215,00 EUR	3800lm	1005756	235,00 EUR
		36°	2620lm	1004599	215,00 EUR	3760lm	1005757	235,00 EUR
		60°	2715lm	1004600	215,00 EUR	3460lm	1005758	235,00 EUR

NUMINOS® CL  
1004227





NUMINOS®  
Luminárias de teto (CL)

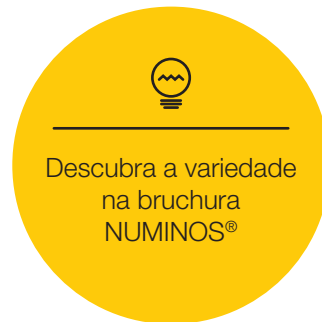

Anel decorativo também disponível em branco



Anel decorativo <i>NUMINOS® S</i>	Ø: 6,2 cm, A: 2 cm	○	<b>1006167</b>	<b>1,30 EUR</b>
Anel decorativo <i>NUMINOS® M</i>	Ø: 8,2 cm, A: 2,4 cm	○	<b>1006168</b>	<b>2,40 EUR</b>
Anel decorativo <i>NUMINOS® L</i>	Ø: 9,65 cm, A: 2,5 cm	○	<b>1006169</b>	<b>2,40 EUR</b>
Anel decorativo <i>NUMINOS® XL</i>	Ø: 11,66 cm, A: 2,85 cm	○	<b>1006170</b>	<b>3,55 EUR</b>

Pode encontrar mais detalhes sobre as medidas e informações de montagem nas páginas 118 e 119

**S** 220-240V ~50/60Hz | 250mA  
Potência total: 11W  
Material: alumínio /poli-carbonato (PC)

**M** 220-240V ~50/60Hz | 500mA  
Potência total: 20W  
Material: alumínio /poli-carbonato (PC)





	2700K	24°	985lm	1004122	102,00 EUR	1925lm	1004218	126,00 EUR
		36°	985lm	1004123	102,00 EUR	1935lm	1004219	126,00 EUR
		60°	980lm	1004124	102,00 EUR	1885lm	1004220	126,00 EUR
	3000K	24°	1020lm	1004130	102,00 EUR	1955lm	1004226	126,00 EUR
		36°	1020lm	1004131	102,00 EUR	1970lm	1004227	126,00 EUR
		60°	1020lm	1004132	102,00 EUR	1880lm	1004228	126,00 EUR
	4000K	24°	1100lm	1004138	102,00 EUR	2125lm	1004234	126,00 EUR
		36°	1100lm	1004139	102,00 EUR	2120lm	1004235	126,00 EUR
		60°	1100lm	1004140	102,00 EUR	2060lm	1004236	126,00 EUR
	2700K	24°	985lm	1004410	150,00 EUR	1925lm	1004506	155,00 EUR
		36°	985lm	1004411	150,00 EUR	1935lm	1004507	155,00 EUR
		60°	980lm	1004412	150,00 EUR	1885lm	1004508	155,00 EUR
	3000K	24°	1020lm	1004418	150,00 EUR	1955lm	1004514	155,00 EUR
		36°	1020lm	1004419	150,00 EUR	1970lm	1004515	155,00 EUR
		60°	1020lm	1004420	150,00 EUR	1880lm	1004516	155,00 EUR
	4000K	24°	1100lm	1004426	150,00 EUR	2125lm	1004522	155,00 EUR
		36°	1100lm	1004427	150,00 EUR	2120lm	1004523	155,00 EUR
		60°	1100lm	1004428	150,00 EUR	2060lm	1004524	155,00 EUR
	2700K	24°	985lm	1004126	102,00 EUR	1925lm	1004222	126,00 EUR
		36°	985lm	1004127	102,00 EUR	1935lm	1004223	126,00 EUR
		60°	980lm	1004128	102,00 EUR	1885lm	1004224	126,00 EUR
	3000K	24°	1020lm	1004134	102,00 EUR	1955lm	1004230	126,00 EUR
		36°	1020lm	1004135	102,00 EUR	1970lm	1004231	126,00 EUR
		60°	1020lm	1004136	102,00 EUR	1880lm	1004232	126,00 EUR
	4000K	24°	1100lm	1004142	102,00 EUR	2125lm	1004238	126,00 EUR
		36°	1100lm	1004143	102,00 EUR	2120lm	1004239	126,00 EUR
		60°	1100lm	1004144	102,00 EUR	2060lm	1004240	126,00 EUR
	2700K	24°	985lm	1004414	150,00 EUR	1925lm	1004510	155,00 EUR
		36°	985lm	1004415	150,00 EUR	1935lm	1004511	155,00 EUR
		60°	980lm	1004416	150,00 EUR	1885lm	1004512	155,00 EUR
	3000K	24°	1020lm	1004422	150,00 EUR	1955lm	1004518	155,00 EUR
		36°	1020lm	1004423	150,00 EUR	1970lm	1004519	155,00 EUR
		60°	1020lm	1004424	150,00 EUR	1880lm	1004520	155,00 EUR
	4000K	24°	1100lm	1004430	150,00 EUR	2125lm	1004526	155,00 EUR
		36°	1100lm	1004431	150,00 EUR	2120lm	1004527	155,00 EUR
		60°	1100lm	1004432	150,00 EUR	2060lm	1004528	155,00 EUR





**L** 220-240V ~50/60Hz | 700mA  
 Potência total: 28W  
 Material: alumínio / policarbonato (PC)

**XL** 220-240V ~50/60Hz | 900mA  
 Potência total: 36W  
 Material: alumínio / policarbonato (PC)

	2700K	24°	2440lm	1004314	146,00 EUR	3290lm	1005687	174,00 EUR
		36°	2400lm	1004315	146,00 EUR	3250lm	1005688	174,00 EUR
		60°	2475lm	1004316	146,00 EUR	2980lm	1005689	174,00 EUR
	3000K	24°	2430lm	1004322	146,00 EUR	3530lm	1005693	174,00 EUR
		36°	2340lm	1004323	146,00 EUR	3490lm	1005694	174,00 EUR
		60°	2400lm	1004324	146,00 EUR	3210lm	1005695	174,00 EUR
	4000K	24°	2675lm	1004330	146,00 EUR	3800lm	1005699	174,00 EUR
		36°	2620lm	1004331	146,00 EUR	3760lm	1005700	174,00 EUR
		60°	2715lm	1004332	146,00 EUR	3460lm	1005701	174,00 EUR
	2700K	24°	2440lm	1004602	198,00 EUR	3290lm	1005759	235,00 EUR
		36°	2400lm	1004603	198,00 EUR	3250lm	1005760	235,00 EUR
		60°	2475lm	1004604	198,00 EUR	2980lm	1005761	235,00 EUR
	3000K	24°	2430lm	1004610	198,00 EUR	3530lm	1005765	235,00 EUR
		36°	2340lm	1004611	198,00 EUR	3490lm	1005766	235,00 EUR
		60°	2400lm	1004612	198,00 EUR	3210lm	1005767	235,00 EUR
	4000K	24°	2675lm	1004618	198,00 EUR	3800lm	1005771	235,00 EUR
		36°	2620lm	1004619	198,00 EUR	3760lm	1005772	235,00 EUR
		60°	2715lm	1004620	198,00 EUR	3460lm	1005773	235,00 EUR
	2700K	24°	2440lm	1004318	146,00 EUR	3290lm	1005690	174,00 EUR
		36°	2400lm	1004319	146,00 EUR	3250lm	1005691	174,00 EUR
		60°	2475lm	1004320	146,00 EUR	2980lm	1005692	174,00 EUR
	3000K	24°	2430lm	1004326	146,00 EUR	3530lm	1005696	174,00 EUR
		36°	2340lm	1004327	146,00 EUR	3490lm	1005697	174,00 EUR
		60°	2400lm	1004328	146,00 EUR	3210lm	1005698	174,00 EUR
	4000K	24°	2675lm	1004334	146,00 EUR	3800lm	1005702	174,00 EUR
		36°	2620lm	1004335	146,00 EUR	3760lm	1005703	174,00 EUR
		60°	2715lm	1004336	146,00 EUR	3460lm	1005704	174,00 EUR
	2700K	24°	2440lm	1004606	198,00 EUR	3290lm	1005762	235,00 EUR
		36°	2400lm	1004607	198,00 EUR	3250lm	1005763	235,00 EUR
		60°	2475lm	1004608	198,00 EUR	2980lm	1005764	235,00 EUR
	3000K	24°	2430lm	1004614	198,00 EUR	3530lm	1005768	235,00 EUR
		36°	2340lm	1004615	198,00 EUR	3490lm	1005769	235,00 EUR
		60°	2400lm	1004616	198,00 EUR	3210lm	1005770	235,00 EUR
	4000K	24°	2675lm	1004622	198,00 EUR	3800lm	1005774	235,00 EUR
		36°	2620lm	1004623	198,00 EUR	3760lm	1005775	235,00 EUR
		60°	2715lm	1004624	198,00 EUR	3460lm	1005776	235,00 EUR

NUMINOS® PD  
1005787





NUMINOS®  
Luminárias suspensas (PD)



Anel decorativo  
também disponível  
em branco



Descubra  
o configurador  
NUMINOS®  
em [slv.com](http://slv.com)



Anel decorativo NUMINOS® S	Ø: 6,2 cm, A: 2 cm	○	1006167	1,30 EUR
Anel decorativo NUMINOS® M	Ø: 8,2 cm, A: 2,4 cm	○	1006168	2,40 EUR
Anel decorativo NUMINOS® L	Ø: 9,65 cm, A: 2,5 cm	○	1006169	2,40 EUR
Anel decorativo NUMINOS® XL	Ø: 11,66 cm, A: 2,85 cm	○	1006170	3,55 EUR

Pode encontrar mais detalhes sobre as medidas e informações de montagem nas páginas 118 e 119



**S** 220-240V ~50/60Hz | 250mA  
Potência total: 11W  
Material: alumínio /poli-carbonato (PC)





**M** 220-240V ~50/60Hz | 500mA  
Potência total: 20W  
Material: alumínio /poli-carbonato (PC)

	2700K	24°	985lm	1004146	140,00 EUR	1925lm	1004242	157,00 EUR
		36°	985lm	1004147	140,00 EUR	1935lm	1004243	157,00 EUR
		60°	980lm	1004148	140,00 EUR	1885lm	1004244	157,00 EUR
	3000K	24°	1020lm	1004154	140,00 EUR	1955lm	1004250	157,00 EUR
		36°	1020lm	1004155	140,00 EUR	1970lm	1004251	157,00 EUR
		60°	1020lm	1004156	140,00 EUR	1880lm	1004252	157,00 EUR
	4000K	24°	1100lm	1004162	140,00 EUR	2125lm	1004258	157,00 EUR
		36°	1100lm	1004163	140,00 EUR	2120lm	1004259	157,00 EUR
		60°	1100lm	1004164	140,00 EUR	2060lm	1004260	157,00 EUR
	2700K	24°	985lm	1004434	198,00 EUR	1925lm	1004530	210,00 EUR
		36°	985lm	1004435	198,00 EUR	1935lm	1004531	210,00 EUR
		60°	980lm	1004436	198,00 EUR	1885lm	1004532	210,00 EUR
	3000K	24°	1020lm	1004442	198,00 EUR	1955lm	1004538	210,00 EUR
		36°	1020lm	1004443	198,00 EUR	1970lm	1004539	210,00 EUR
		60°	1020lm	1004444	198,00 EUR	1880lm	1004540	210,00 EUR
	4000K	24°	1100lm	1004450	198,00 EUR	2125lm	1004546	210,00 EUR
		36°	1100lm	1004451	198,00 EUR	2120lm	1004547	210,00 EUR
		60°	1100lm	1004452	198,00 EUR	2060lm	1004548	210,00 EUR
	2700K	24°	985lm	1004150	140,00 EUR	1925lm	1004246	157,00 EUR
		36°	985lm	1004151	140,00 EUR	1935lm	1004247	157,00 EUR
		60°	980lm	1004152	140,00 EUR	1885lm	1004248	157,00 EUR
	3000K	24°	1020lm	1004158	140,00 EUR	1955lm	1004254	157,00 EUR
		36°	1020lm	1004159	140,00 EUR	1970lm	1004255	157,00 EUR
		60°	1020lm	1004160	140,00 EUR	1880lm	1004256	157,00 EUR
	4000K	24°	1100lm	1004166	140,00 EUR	2125lm	1004262	157,00 EUR
		36°	1100lm	1004167	140,00 EUR	2120lm	1004263	157,00 EUR
		60°	1100lm	1004168	140,00 EUR	2060lm	1004264	157,00 EUR
	2700K	24°	985lm	1004438	198,00 EUR	1925lm	1004534	210,00 EUR
		36°	985lm	1004439	198,00 EUR	1935lm	1004535	210,00 EUR
		60°	980lm	1004440	198,00 EUR	1885lm	1004536	210,00 EUR
	3000K	24°	1020lm	1004446	198,00 EUR	1955lm	1004542	210,00 EUR
		36°	1020lm	1004447	198,00 EUR	1970lm	1004543	210,00 EUR
		60°	1020lm	1004448	198,00 EUR	1880lm	1004544	210,00 EUR
	4000K	24°	1100lm	1004454	198,00 EUR	2125lm	1004550	210,00 EUR
		36°	1100lm	1004455	198,00 EUR	2120lm	1004551	210,00 EUR
		60°	1100lm	1004456	198,00 EUR	2060lm	1004552	210,00 EUR



**L** 220-240V ~50/60Hz | 700mA  
 Potência total: 28W  
 Material: alumínio /poli-carbonato (PC)

**XL** 220-240V ~50/60Hz | 900mA  
 Potência total: 36W  
 Material: alumínio /poli-carbonato (PC)

	2700K	24°	2440lm	1004338	172,00 EUR	3290lm	1005705	198,00 EUR
		36°	2400lm	1004339	172,00 EUR	3250lm	1005706	198,00 EUR
		60°	2475lm	1004340	172,00 EUR	2980lm	1005707	198,00 EUR
	3000K	24°	2430lm	1004346	172,00 EUR	3530lm	1005711	198,00 EUR
		36°	2340lm	1004347	172,00 EUR	3490lm	1005712	198,00 EUR
		60°	2400lm	1004348	172,00 EUR	3210lm	1005713	198,00 EUR
	4000K	24°	2675lm	1004354	172,00 EUR	3800lm	1005717	198,00 EUR
		36°	2620lm	1004355	172,00 EUR	3760lm	1005718	198,00 EUR
		60°	2715lm	1004356	172,00 EUR	3460lm	1005719	198,00 EUR
	2700K	24°	2440lm	1004626	228,00 EUR	3290lm	1005777	254,00 EUR
		36°	2400lm	1004627	228,00 EUR	3250lm	1005778	254,00 EUR
		60°	2475lm	1004628	228,00 EUR	2980lm	1005779	254,00 EUR
	3000K	24°	2430lm	1004634	228,00 EUR	3530lm	1005783	254,00 EUR
		36°	2340lm	1004635	228,00 EUR	3490lm	1005784	254,00 EUR
		60°	2400lm	1004636	228,00 EUR	3210lm	1005785	254,00 EUR
	4000K	24°	2675lm	1004642	228,00 EUR	3800lm	1005789	254,00 EUR
		36°	2620lm	1004643	228,00 EUR	3760lm	1005790	254,00 EUR
		60°	2715lm	1004644	228,00 EUR	3460lm	1005791	254,00 EUR
	2700K	24°	2440lm	1004342	172,00 EUR	3290lm	1005708	198,00 EUR
		36°	2400lm	1004343	172,00 EUR	3250lm	1005709	198,00 EUR
		60°	2475lm	1004344	172,00 EUR	2980lm	1005710	198,00 EUR
	3000K	24°	2430lm	1004350	172,00 EUR	3530lm	1005714	198,00 EUR
		36°	2340lm	1004351	172,00 EUR	3490lm	1005715	198,00 EUR
		60°	2400lm	1004352	172,00 EUR	3210lm	1005716	198,00 EUR
	4000K	24°	2675lm	1004358	172,00 EUR	3800lm	1005720	198,00 EUR
		36°	2620lm	1004359	172,00 EUR	3760lm	1005721	198,00 EUR
		60°	2715lm	1004360	172,00 EUR	3460lm	1005722	198,00 EUR
	2700K	24°	2440lm	1004630	228,00 EUR	3290lm	1005780	254,00 EUR
		36°	2400lm	1004631	228,00 EUR	3250lm	1005781	254,00 EUR
		60°	2475lm	1004632	228,00 EUR	2980lm	1005782	254,00 EUR
	3000K	24°	2430lm	1004638	228,00 EUR	3530lm	1005786	254,00 EUR
		36°	2340lm	1004639	228,00 EUR	3490lm	1005787	254,00 EUR
		60°	2400lm	1004640	228,00 EUR	3210lm	1005788	254,00 EUR
	4000K	24°	2675lm	1004646	228,00 EUR	3800lm	1005792	254,00 EUR
		36°	2620lm	1004647	228,00 EUR	3760lm	1005793	254,00 EUR
		60°	2715lm	1004648	228,00 EUR	3460lm	1005794	254,00 EUR

NUMINOS® 3-PH. TRACK  
1004083



NUMINOS®  
Sistema de calhas eletrificadas de  
3 circuitos (trifásico)



Descubra as luminárias  
NUMINOS® também para  
o sistema de 48V  
P. 468–471



NUMINOS® 3-PH. TRACK  
1004082



Anel decorativo  
também disponível  
em branco



Anel decorativo NUMINOS® S	Ø: 6,2 cm, A: 2 cm	○	1006167	1,30 EUR
Anel decorativo NUMINOS® M	Ø: 8,2 cm, A: 2,4 cm	○	1006168	2,40 EUR
Anel decorativo NUMINOS® L	Ø: 9,65 cm, A: 2,5 cm	○	1006169	2,40 EUR
Anel decorativo NUMINOS® XL	Ø: 11,66 cm, A: 2,85 cm	○	1006170	3,55 EUR

Pode encontrar mais detalhes sobre as medidas e informações de montagem nas páginas 118 e 119



**S** 220-240V ~50/60Hz | 250mA  
Potência total: 11W  
Material: alumínio /poli-carbonato (PC)

**M** 220-240V ~50/60Hz | 500mA  
Potência total: 20W  
Material: alumínio /poli-carbonato (PC)





	2700K	24°	985lm	1004074	115,00 EUR	1925lm	1004170	145,00 EUR
		36°	985lm	1004075	115,00 EUR	1935lm	1004171	145,00 EUR
		60°	980lm	1004076	115,00 EUR	1885lm	1004172	145,00 EUR
	3000K	24°	1020lm	1004082	115,00 EUR	1955lm	1004178	145,00 EUR
		36°	1020lm	1004083	115,00 EUR	1970lm	1004179	145,00 EUR
		60°	1020lm	1004084	115,00 EUR	1880lm	1004180	145,00 EUR
	4000K	24°	1100lm	1004090	115,00 EUR	2125lm	1004186	145,00 EUR
		36°	1100lm	1004091	115,00 EUR	2120lm	1004187	145,00 EUR
		60°	1100lm	1004092	115,00 EUR	2060lm	1004188	145,00 EUR
	2700K	24°	985lm	1004362	165,00 EUR	1925lm	1004458	197,00 EUR
		36°	985lm	1004363	165,00 EUR	1935lm	1004459	197,00 EUR
		60°	980lm	1004364	165,00 EUR	1885lm	1004460	197,00 EUR
	3000K	24°	1020lm	1004370	165,00 EUR	1955lm	1004466	197,00 EUR
		36°	1020lm	1004371	165,00 EUR	1970lm	1004467	197,00 EUR
		60°	1020lm	1004372	165,00 EUR	1880lm	1004468	197,00 EUR
	4000K	24°	1100lm	1004378	165,00 EUR	2125lm	1004474	197,00 EUR
		36°	1100lm	1004379	165,00 EUR	2120lm	1004475	197,00 EUR
		60°	1100lm	1004380	165,00 EUR	2060lm	1004476	197,00 EUR
	2700K	24°	985lm	1004078	115,00 EUR	1925lm	1004174	145,00 EUR
		36°	985lm	1004079	115,00 EUR	1935lm	1004175	145,00 EUR
		60°	980lm	1004080	115,00 EUR	1885lm	1004176	145,00 EUR
	3000K	24°	1020lm	1004086	115,00 EUR	1955lm	1004182	145,00 EUR
		36°	1020lm	1004087	115,00 EUR	1970lm	1004183	145,00 EUR
		60°	1020lm	1004088	115,00 EUR	1880lm	1004184	145,00 EUR
	4000K	24°	1100lm	1004094	115,00 EUR	2125lm	1004190	145,00 EUR
		36°	1100lm	1004095	115,00 EUR	2120lm	1004191	145,00 EUR
		60°	1100lm	1004096	115,00 EUR	2060lm	1004192	145,00 EUR
	2700K	24°	985lm	1004366	165,00 EUR	1925lm	1004462	197,00 EUR
		36°	985lm	1004367	165,00 EUR	1935lm	1004463	197,00 EUR
		60°	980lm	1004368	165,00 EUR	1885lm	1004464	197,00 EUR
	3000K	24°	1020lm	1004374	165,00 EUR	1955lm	1004470	197,00 EUR
		36°	1020lm	1004375	165,00 EUR	1970lm	1004471	197,00 EUR
		60°	1020lm	1004376	165,00 EUR	1880lm	1004472	197,00 EUR
	4000K	24°	1100lm	1004382	165,00 EUR	2125lm	1004478	197,00 EUR
		36°	1100lm	1004383	165,00 EUR	2120lm	1004479	197,00 EUR
		60°	1100lm	1004384	165,00 EUR	2060lm	1004480	197,00 EUR





**L** 220-240V ~50/60Hz | 700mA  
 Potência total: 28W  
 Material: alumínio /poli-carbonato (PC)

**XL** 220-240V ~50/60Hz | 900mA  
 Potência total: 36W  
 Material: alumínio /poli-carbonato (PC)

	2700K	24°	2440lm	1004266	155,00 EUR	3290lm	1005723	165,00 EUR
		36°	2400lm	1004267	155,00 EUR	3250lm	1005724	165,00 EUR
		60°	2475lm	1004268	155,00 EUR	2980lm	1005725	165,00 EUR
	3000K	24°	2430lm	1004274	155,00 EUR	3530lm	1005729	165,00 EUR
		36°	2340lm	1004275	155,00 EUR	3490lm	1005730	165,00 EUR
		60°	2400lm	1004276	155,00 EUR	3210lm	1005731	165,00 EUR
	4000K	24°	2675lm	1004282	155,00 EUR	3800lm	1005735	165,00 EUR
		36°	2620lm	1004283	155,00 EUR	3760lm	1005736	165,00 EUR
		60°	2715lm	1004284	155,00 EUR	3460lm	1005737	165,00 EUR
	2700K	24°	2440lm	1004554	215,00 EUR	3290lm	1005795	235,00 EUR
		36°	2400lm	1004555	215,00 EUR	3250lm	1005796	235,00 EUR
		60°	2475lm	1004556	215,00 EUR	2980lm	1005797	235,00 EUR
	3000K	24°	2430lm	1004562	215,00 EUR	3530lm	1005801	235,00 EUR
		36°	2340lm	1004563	215,00 EUR	3490lm	1005802	235,00 EUR
		60°	2400lm	1004564	215,00 EUR	3210lm	1005803	235,00 EUR
	4000K	24°	2675lm	1004570	215,00 EUR	3800lm	1005807	235,00 EUR
		36°	2620lm	1004571	215,00 EUR	3760lm	1005808	235,00 EUR
		60°	2715lm	1004572	215,00 EUR	3460lm	1005809	235,00 EUR
	2700K	24°	2440lm	1004270	155,00 EUR	3290lm	1005726	165,00 EUR
		36°	2400lm	1004271	155,00 EUR	3250lm	1005727	165,00 EUR
		60°	2475lm	1004272	155,00 EUR	2980lm	1005728	165,00 EUR
	3000K	24°	2430lm	1004278	155,00 EUR	3530lm	1005732	165,00 EUR
		36°	2340lm	1004279	155,00 EUR	3490lm	1005733	165,00 EUR
		60°	2400lm	1004280	155,00 EUR	3210lm	1005734	165,00 EUR
	4000K	24°	2675lm	1004286	155,00 EUR	3800lm	1005738	165,00 EUR
		36°	2620lm	1004287	155,00 EUR	3760lm	1005739	165,00 EUR
		60°	2715lm	1004288	155,00 EUR	3460lm	1005740	165,00 EUR
	2700K	24°	2440lm	1004558	215,00 EUR	3290lm	1005798	235,00 EUR
		36°	2400lm	1004559	215,00 EUR	3250lm	1005799	235,00 EUR
		60°	2475lm	1004560	215,00 EUR	2980lm	1005800	235,00 EUR
	3000K	24°	2430lm	1004566	215,00 EUR	3530lm	1005804	235,00 EUR
		36°	2340lm	1004567	215,00 EUR	3490lm	1005805	235,00 EUR
		60°	2400lm	1004568	215,00 EUR	3210lm	1005806	235,00 EUR
	4000K	24°	2675lm	1004574	215,00 EUR	3800lm	1005810	235,00 EUR
		36°	2620lm	1004575	215,00 EUR	3760lm	1005811	235,00 EUR
		60°	2715lm	1004576	215,00 EUR	3460lm	1005812	235,00 EUR

NUMINOS® ZOOM  
1006117



short. Smile while you still have tact





# NUMINOS® ZOOM

Sistema de calha trifásica



**M** 220-240V ~50/60Hz | 500mA  
 Potência total: 20W  
 Material: alumínio / policarbonato (PC)



		2700K	15°-60°	680-1650lm	1006108	183,00 EUR
		3000K	15°-60°	750-1800lm	1006110	183,00 EUR
		4000K	15°-60°	780-1900lm	1006112	183,00 EUR
		2700K	15°-60°	680-1650lm	1006114	232,00 EUR
		3000K	15°-60°	750-1800lm	1006116	232,00 EUR
		4000K	15°-60°	780-1900lm	1006118	232,00 EUR
		2700K	15°-60°	680-1650lm	1006109	183,00 EUR
		3000K	15°-60°	750-1800lm	1006111	183,00 EUR
		4000K	15°-60°	780-1900lm	1006113	183,00 EUR
		2700K	15°-60°	680-1650lm	1006115	232,00 EUR
		3000K	15°-60°	750-1800lm	1006117	232,00 EUR
		4000K	15°-60°	780-1900lm	1006119	232,00 EUR



Ângulo de meia dispersão regulável de 15°-60°

Pode encontrar mais detalhes sobre as medidas e informações de montagem nas páginas 118 e 119

# CONFIGURE O SEU NUMINOS®

---

SELECIONE O SEU

SISTEMA

COR

NUMINOS® DL

NUMINOS® MOVE

NUMINOS® GIMBLE

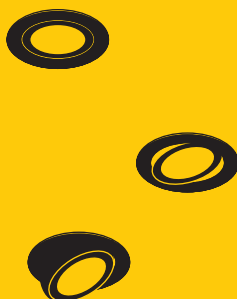

NUMINOS® PROJECTOR



NUMINOS® PD

NUMINOS® CL

NUMINOS® SPOT



NUMINOS® TRACK

NUMINOS® ZOOM



O sistema de iluminação NUMINOS® oferece propriedades de iluminação constantes e design moderno em todas as aplicações: desde hotéis a escritórios, passando por espaços comerciais ou privados. Da aplicação à tecnologia e ao design em detalhes: uma boa característica é que os downlights e projetores modulares podem ser configurados exatamente conforme a necessidade, dependendo do design ou espaço em questão. E quantumAis multifacetado for o seu projeto, mais vai beneficiar com o sistema de iluminação NUMINOS®.



Descubra a iluminação NUMINOS® também para o sistema de 48V P. 468–471

## DIMENSÃO

## DESEMPENHO

## DIFUSORES

**XS**

**S**

**M**

**L**

**XL**

**XS**

200mA  
Consumo de energia: 7W

**S**

250mA  
Consumo de energia: 8,6W

**M**

500mA  
Consumo de energia: 17,5W

**L**

700mA  
Consumo de energia: 25,4W

**XL**

1050mA  
Consumo de energia: 37,4W

### ELÍPTICO

Luz distribuída longitudinalmente, encadeamento reduzido, ideal para utilização em corredores

### PRISMÁTICO

Feixe de luzmAis largo, baixo encadeamento, perfeito para colocar as luminárias a distâncias específicas

**XS**

**S**

**M**

**L**

**XS**

200mA  
Consumo de energia: 7W

**S**

250mA  
Consumo de energia: 8,6W

**M**

500mA  
Consumo de energia: 17,5W

**L**

700mA  
Consumo de energia: 25,4W

### FOSCO

Feixe de luzmAis largo, maior iluminação, ideal para tetos baixos

### ALVEOLAR

Feixe de luz estreito, encadeamento reduzido, ideal para trabalhar no computador

Pode encontrar os controladores adequados nas páginas 94 e 95

**S**

**M**

**L**

**XL**

**S**

250mA  
Consumo de energia: 11W

**M**

500mA  
Consumo de energia: 20W

**L**

700mA  
Consumo de energia: 28W

**XL**

900mA  
Consumo de energia: 36W

**S**

**M**

**L**

**XL**

NUMINOS® Zoom apenas disponível no tamanho M

# NUMINOS®

## DOWNLIGHTS

**XS**

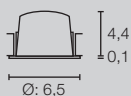

Dimensões de encastramento:  
Ø: 5,5 cm P: 11,0 cm

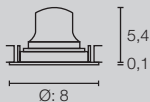

Dimensões de encastramento:  
Ø: 6,8 cm P: 8 cm

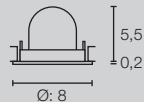

Dimensões de encastramento:  
Ø: 6,8 cm P: 8 cm

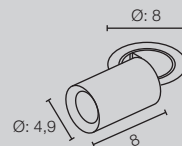

Dimensões de encastramento:  
Ø: 6,8 cm P: 10 cm

**S**

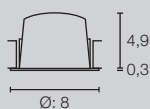

Dimensões de encastramento:  
Ø: 6,8 cm P: 5,5 cm

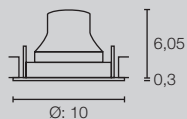

Dimensões de encastramento:  
Ø: 9 cm P: 8,5 cm

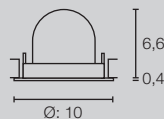

Dimensões de encastramento:  
Ø: 9 cm P: 7 cm

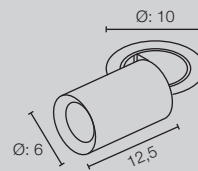

Dimensões de encastramento:  
Ø: 8,8 cm P: 15 cm

**M**

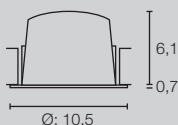

Dimensões de encastramento:  
Ø: 9 cm P: 7,5 cm

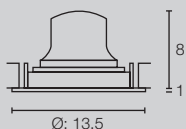

Dimensões de encastramento:  
Ø: 12 cm P: 10 cm

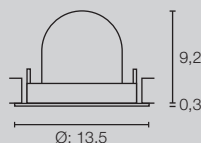

Dimensões de encastramento:  
Ø: 12 cm P: 10 cm

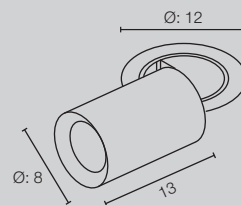

Dimensões de encastramento:  
Ø: 10,5 cm P: 15 cm

**L**

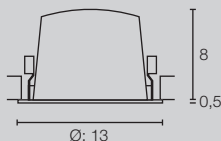

Dimensões de encastramento:  
Ø: 11,7 cm P: 9 cm

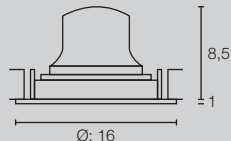

Dimensões de encastramento:  
Ø: 14,5 cm P: 10,5 cm

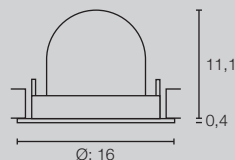

Dimensões de encastramento:  
Ø: 14,5 cm P: 11,5 cm

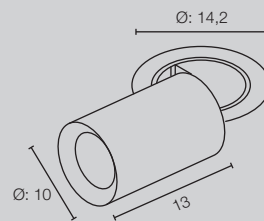

Dimensões de encastramento:  
Ø: 13 cm P: 15 cm

**XL**

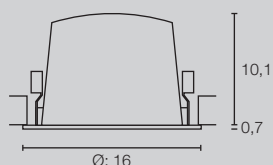

Dimensões de encastramento:  
Ø: 14,5 cm P: 11,5 cm

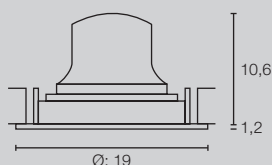

Dimensões de encastramento:  
Ø: 17,5 cm P: 13 cm

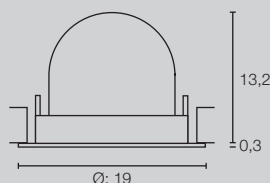

Dimensões de encastramento:  
Ø: 17,5 cm P: 13,5 cm

**NUMINOS®  
DL**

**NUMINOS®  
MOVE**

**NUMINOS®  
GIMBLE**

**NUMINOS®  
PROJECTOR**

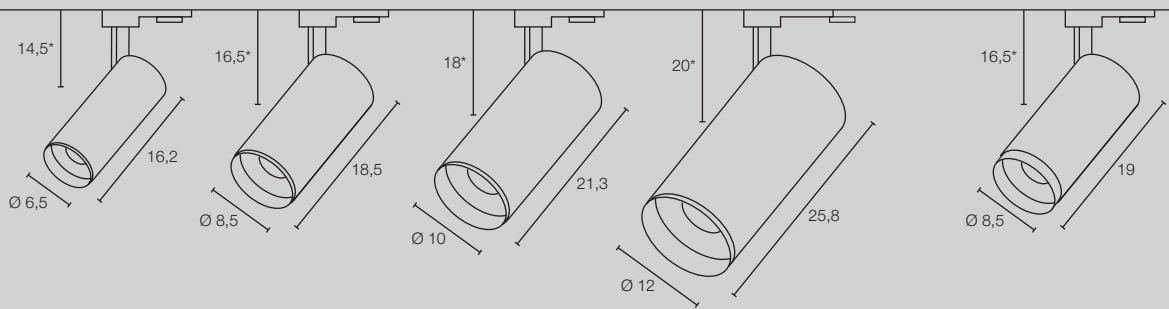
**S****M****L****XL****M****NUMINOS® TRACK**

\* Para ângulos inferiores a 90°

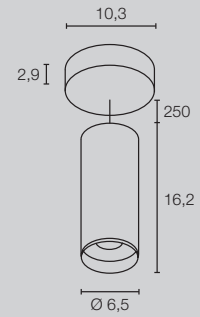
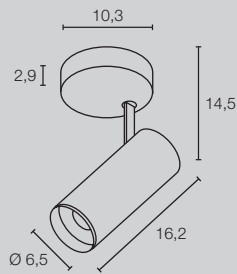
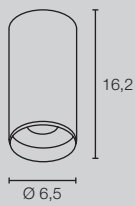
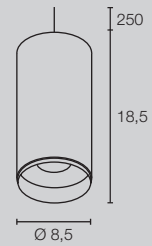
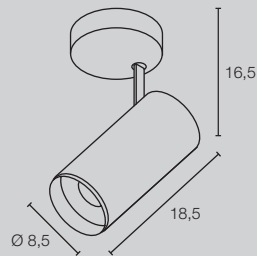
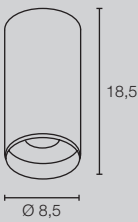
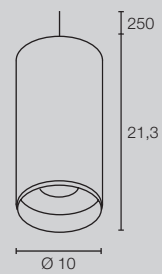
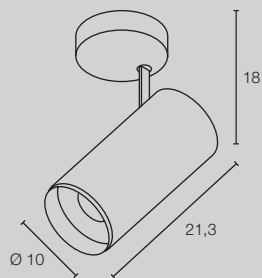
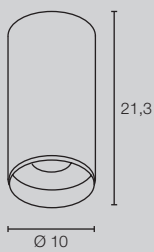
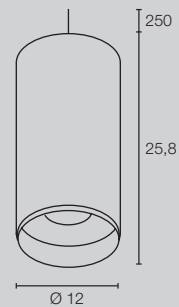
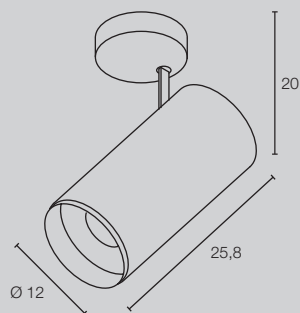
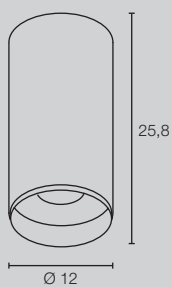
**NUMINOS® ZOOM****LUMINÁRIAS PARA PAREDE E TETO****S****M****L****XL****NUMINOS®  
CL****NUMINOS®  
CW****NUMINOS®  
PD**

# NUMINOS®

## DOWN-/SPOTLIGHTS

---



Descubra  
o configurador  
NUMINOS®  
em [slv.com](http://slv.com)

Disponível em sete versões  
com módulo LED de  
alta performance em três  
temperaturas de cor e graus  
de encadeamento.

---

Refletores seleccionáveis com  
ângulos de meia dispersão  
de 20° a 55°.

---

Diferentes filtros de efeitos  
disponíveis como acessórios.

---

O anel decorativo pode ser  
seleccionado como acabamento  
visível.

---

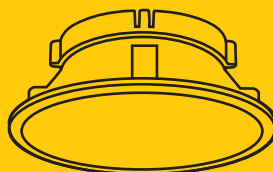
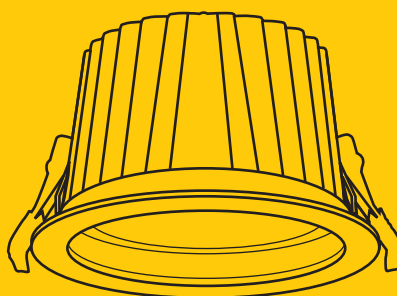

## DOWNLIGHTS

Os downlights NUMINOS® estão disponíveis nas variantes fixas ou orientáveis.



NUMINOS® UM SISTEMA DE ILUMINAÇÃO – MIL POSSIBILIDADES. O sistema de iluminação livremente configurável que coloca a melhor iluminação em todos os ambientes. Não existem dois projetos iguais. No entanto, muitos projetos exigem um conceito coerente de iluminação e design. O sistema NUMINOS® é um sistema de iluminação perfeitamente coordenado que harmoniza a função, o design e a tecnologia. Para projetistas e executantes. Para todos os requisitos. Para a máxima diversidade com o mínimo de esforço.

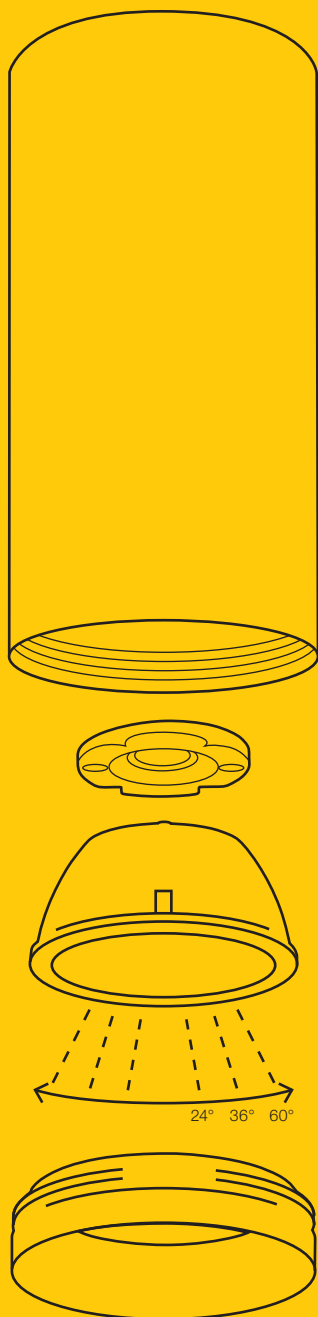

Disponível em três dimensões com módulo LED de alta performance em três temperaturas de cor.

Graças ao controlador LED integrado, todos os Spotlights (projetores) são adequados para ligação direta à tensão de rede de 230 VAC.

Lentes seleccionáveis com ângulos de meia dispersão de 24° a 60°.

O anel decorativo pode ser seleccionado como acabamento visível.

## SPOTLIGHTS

Os projetores NUMINOS® estão disponíveis nas versões de teto fixos ou orientáveis, suspensos e como projetores para sistemas de calhas eletrificadas trifásicas.

NEW TRIA®  
1007334

COMBINE



Casquilho GU10 ou módulo LED

+



Anel de montagem  
nas cores preto, branco,  
rosa dourado, alumínio

=





## NEW TRIA® Downlight (DL)



NEW



Sistema Plug & Play modular  
para flexibilidade máxima



Excelente índice de reprodução  
cromática > 90



Versão  
IP65

Instalação fácil graças  
ao Quick Connector



### CONJUNTOS NEW TRIA®

*Encontre os conjuntos dos nossos artigos mais  
vendidos já combinados nas páginas 132 a 139*

## MÓDULOS LED PARA ANEIS COM DIÂMETRO DE 68 E 75 mm

NEW

### NEW TRIA® DL, Módulo LED, Phase



220-240V ~50/60Hz  
Material: alumínio

	IP20	200mA	8,3W	2700K	705lm	1007381	45,00 EUR
				3000K	750lm	1007383	45,00 EUR



### NEW TRIA® DL, Módulo LED, Phase



220-240V ~50/60Hz  
Material: alumínio

	IP20	200mA	8,3W	2700K	705lm	1007382	45,00 EUR
				3000K	750lm	1007384	45,00 EUR



## MÓDULO DIM-TO-WARM PARA ANEIS COM DIÂMETRO DE 68 E 75 mm

### NEW TRIA® DL, Módulo LED, DTW, Phase



220-240V ~50/60Hz  
Material: alumínio

	IP20	250mA	11W	1800 - 3000K	700lm	1007421	56,00 EUR
--	------	-------	-----	--------------	-------	---------	-----------



### NEW TRIA® DL, Módulo LED, DTW, Phase



220-240V ~50/60Hz  
Material: alumínio

	IP20	250mA	11W	1800 - 3000 K	700lm	1007422	56,00 EUR
--	------	-------	-----	---------------	-------	---------	-----------



## DIM-TO-WARM (DTW)

*Com a função Dim-to-Warm é possível regular a temperatura de cor e brilho das luminárias. Assim, ao diminuir a quantidade luminica, a luz muda de brilhante e fria para uma luz suave e quente.*

Todas as indicações de potência (watts) referem-se à potência total da luminária.

Pode encontrar mais detalhes sobre as medidas e informações de montagem nas páginas 128 e 129



## MÓDULO MULTI WATTAGE 3 CCT PARA ANEIS COM DIÂMETRO DE 68 E 75 mm

NEW TRIA® UNIVERSAL  
DL, Módulo LED, Phase220-240V ~50/60Hz  
Material: alumínio

● ● IP20 100 - 180mA 4,6 - 8,6W CCT 2500 / 3000 / 4000K 540 / 600 / 600lm 1007431 ● 76,00 EUR

NEW TRIA® UNIVERSAL  
DL, Módulo LED, Phase220-240V ~50/60Hz  
Material: alumínio

● ● IP20 100 - 180mA 4,6 - 8,6W CCT 2500 / 3000 / 4000K 540 / 600 / 600lm 1007432 ● 76,00 EUR



## CASQUILHO GU10 PARA ANEIS COM DIÂMETRO DE 68 E 75 mm

GU10 LED CONNECTION BOX  
com base220-240V ~50/60Hz  
Material: alumínio

● - IP20 - &lt;10W - - 1007283 ● 6,00 EUR

Encontra a lâmpada adequada na página 860



## MÓDULOS LED PARA ANEIS COM DIÂMETRO DE 95 mm













NEW TRIA®  
DL, Módulo LED, Phase220-240V ~50/60Hz  
Material: alumínio● ● IP20 350mA 13,3W 2700K 1130lm 1007409 ● 95,00 EUR  
● ● IP20 350mA 13,3W 3000K 1200lm 1007410 ● 95,00 EURNEW TRIA®  
DL, Módulo LED, Phase220-240V ~50/60Hz  
Material: alumínio● ● IP20 350mA 13,3W 2700K 1130lm 1007411 ● 95,00 EUR  
● ● IP20 350mA 13,3W 3000K 1200lm 1007412 ● 95,00 EUR

## SELECIONE O SEU ANEL DE MONTAGEM:



NEW



### ADEQUADO PARA TODOS OS MÓDULOS E CASQUILHO GU10 COM ANEIS DE DIÂMETROS 68/75

	preto			1007332	14,90 EUR	
NEW TRIA® 68 <i>Anel redondo, GU10/módulo LED</i>	Branco	IP20	Ø: 8,2 cm, A: 2,6 cm	1007333	14,90 EUR	
	rosa dourado			1007334	24,90 EUR	
	Alumínio			1007335	19,90 EUR	
	preto			1007329	14,90 EUR	
NEW TRIA® 68 <i>Anel quadrado, GU10/módulo LED</i>	Branco	IP20	C: 8,2 cm, L: 8,2 cm, A: 2,6 cm	1007328	14,90 EUR	
	rosa dourado			1007331	24,90 EUR	
	Alumínio			1007330	19,90 EUR	
	preto			1007451	15,90 EUR	
NEW TRIA® 68 <i>Anel redondo, GU10/módulo LED</i>	Branco	IP20	Ø: 8,2 cm, A: 4,4 cm	1007453	15,90 EUR	
	preto			1007345	24,90 EUR	
NEW TRIA® 68 <i>Anel redondo, GU10/módulo LED</i>	Branco	IP65	Ø: 8,2 cm, A: 3,4 cm	1007346	24,90 EUR	
	preto			1007347	24,90 EUR	
NEW TRIA® 68 <i>Anel quadrado, GU10/módulo LED</i>	Branco	IP65	C: 8,2 cm, L: 8,2 cm, A: 3,4 cm	1007348	24,90 EUR	
	preto			1007336	35,90 EUR	
NEW TRIA® 68 <i>Anel redondo, GU10/módulo LED com vidro decorativo</i>	Branco	IP65	Ø: 8,3 cm, A: 3,6 cm	1007337	35,90 EUR	
	preto			1007338	35,90 EUR	
NEW TRIA® 68 <i>Anel quadrado, GU10/módulo LED com vidro decorativo</i>	Branco	IP65	C: 8,3 cm, L: 8,3 cm, A: 3,6 cm	1007339	35,90 EUR	
	preto			1007343	19,90 EUR	
NEW TRIA® 75 <i>Anel redondo, GU10/módulo LED</i>	Branco	IP20	Ø: 9,3 cm, A: 2,6 cm	1007342	19,90 EUR	
	rosa dourado			1007344	28,90 EUR	
	Alumínio			1007351	23,90 EUR	
	preto			1007340	19,90 EUR	
NEW TRIA® 75 <i>Anel quadrado, GU10/módulo LED</i>	Branco	IP20	C: 9 cm, L: 9 cm, A: 2,6 cm	1007349	19,90 EUR	
	rosa dourado			1007341	28,90 EUR	
	Alumínio			1007350	23,90 EUR	
	preto			1007449	18,90 EUR	
NEW TRIA® 75 <i>Anel redondo, GU10/módulo LED Com anel sobressaído</i>	Branco	IP20	Ø: 8,2 cm, A: 4,9 cm	1007450	18,90 EUR	
	preto			1007488	14,90 EUR	
NEW TRIA® 75 <i>Anel redondo, GU10/módulo LED Com aro reduzido</i>	Branco	IP20	Ø: 8,2 cm, A: 4,3 cm	1007489	14,90 EUR	
	preto			1007631	24,90 EUR	
NEW TRIA® 75 XL <i>Anel redondo, GU10/módulo LED</i>	Branco	IP20	Ø: 11 cm, A: 2,6 cm	1007630	24,90 EUR	
	rosa dourado			1007633	33,90 EUR	
	Alumínio			1007632	28,90 EUR	
	preto			1007635	24,90 EUR	
NEW TRIA® 75 XL <i>Anel quadrado, GU10/módulo LED</i>	Branco	IP20	C: 11 cm, L: 11 cm, A: 2,6 cm	1007634	24,90 EUR	
	rosa dourado			1007637	33,90 EUR	
	Alumínio			1007636	28,90 EUR	
	preto			1007444	29,90 EUR	

### ADEQUADO A TODOS OS MÓDULOS COM ANEIS DE DIÂMETRO 95

	preto			1007444	29,90 EUR	
NEW TRIA® 95 <i>Anel redondo, módulo LED</i>	Branco	IP20	Ø: 11 cm, A: 2,6 cm	1007443	29,90 EUR	
	rosa dourado			1007447	39,90 EUR	
	Alumínio			1007445	34,90 EUR	
	preto			1007452	29,90 EUR	
NEW TRIA® 95 <i>Anel redondo, módulo LED</i>	Branco	IP20	Ø: 10,3 cm, A: 5,5 cm	1007454	29,90 EUR	
	preto			1007446	29,90 EUR	
NEW TRIA® 95 <i>Anel, quadrado, GU10/módulo LED</i>	Branco	IP20	C: 11 cm, L: 11 cm, A: 2,6 cm	1007448	29,90 EUR	
	preto					



Com vidro decorativo



30° orientável



Rotativo e 30° orientável



Com anel sobressaído



Com aro reduzido



# NEW TRIA®

MÓDULOS LED PARA TODOS OS ANEIS COM DIÂMETRO 68 e 75 mm

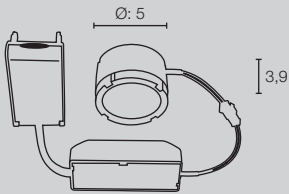

1007381 - 384

**NEW TRIA®**  
DL, MÓDULO LED, PHASE

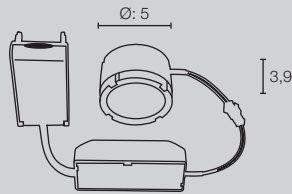

1007421 - 422

**NEW TRIA®**  
DL, MÓDULO LED, DTW, PHASE

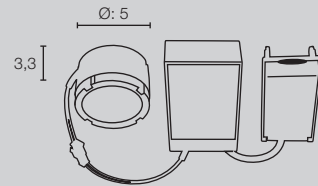

1007431 - 432

**NEW TRIA® UNIVERSAL**  
DL, MÓDULO LED, PHASE

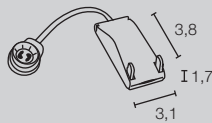

1007283

**GU10 LED CONNECTION BOX**  
COM CASQUILHO

MÓDULOS LED PARA ANEIS  
COM DIÂMETRO 95 mm

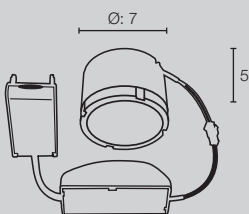

1007409, 1007410 - 412

**NEW TRIA®**  
DL, MÓDULO LED, PHASE

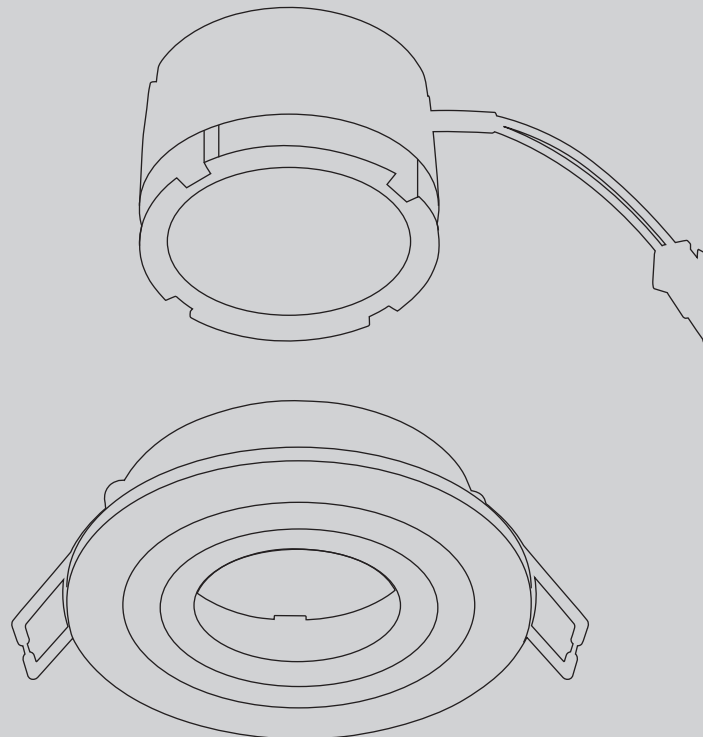



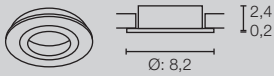

Dimensões de encastramento:  
 Ø: 6,8 cm  
 1007332 - 335

**NEW TRIA® 68**  
 ANEL, REDONDO,  
 GU10/MÓDULO LED

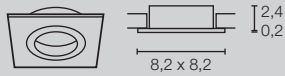

Dimensões de encastramento:  
 Ø: 6,8 cm  
 1007328 - 331

**NEW TRIA® 68**  
 ANEL, QUADRADO,  
 GU10/MÓDULO LED

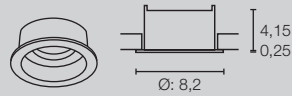

Dimensões de encastramento:  
 Ø: 6,8 cm  
 1007451, 1007453

**NEW TRIA® 68**  
 ANEL, REDONDO,  
 GU10/MÓDULO LED

Versão  
 IP65

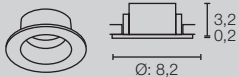

Dimensões de encastramento:  
 Ø: 6,8 cm  
 1007345 - 346

**NEW TRIA® 68**  
 ANEL, REDONDO,  
 GU10/MÓDULO LED

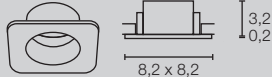

Dimensões de encastramento:  
 Ø: 6,8 cm  
 1007347 - 348

**NEW TRIA® 68**  
 ANEL, QUADRADO,  
 GU10/MÓDULO LED

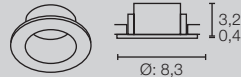

Dimensões de encastramento:  
 Ø: 6,8 cm  
 1007336 - 337

**NEW TRIA® 68**  
 ANEL, REDONDO,  
 GU10/MÓDULO LED

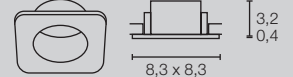

Dimensões de encastramento:  
 Ø: 6,8 cm  
 1007338 - 339

**NEW TRIA® 68**  
 ANEL, QUADRADO,  
 GU10/MÓDULO LED

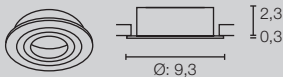

Dimensões de encastramento:  
 Ø: 7,5 cm  
 1007342 - 344, 1007351

**NEW TRIA® 75**  
 ANEL, REDONDO,  
 GU10/MÓDULO LED

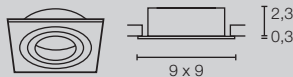

Dimensões de encastramento:  
 Ø: 7,5 cm  
 1007340 - 341, 1007349 - 350

**NEW TRIA® 75**  
 ANEL, QUADRADO,  
 GU10/MÓDULO LED

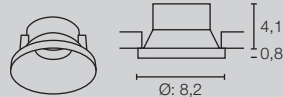

Dimensões de encastramento:  
 Ø: 7,5 cm  
 1007449 - 450

**NEW TRIA® 75**  
 ANEL, REDONDO,  
 GU10/MÓDULO LED

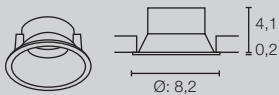

Dimensões de encastramento:  
 Ø: 7,5 cm  
 1007488 - 489

**NEW TRIA® 75**  
 ANEL, REDONDO,  
 GU10/MÓDULO LED

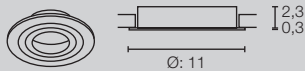

Dimensões de encastramento:  
 Ø: 7,5 cm  
 1007630 - 633

**NEW TRIA® 75 XL**  
 ANEL, REDONDO,  
 GU10/MÓDULO LED

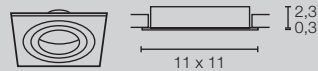

Dimensões de encastramento:  
 Ø: 7,5 cm  
 1007634 - 637

**NEW TRIA® 75 XL**  
 ANEL, QUADRADO,  
 GU10/MÓDULO LED

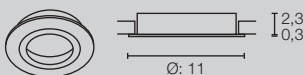

Dimensões de encastramento:  
 Ø: 9,5 cm  
 1007443 - 445, 1007447

**NEW TRIA® 95**  
 ANEL, REDONDO,  
 MÓDULO LED

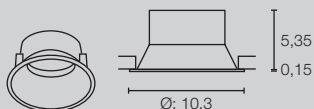

Dimensões de encastramento:  
 Ø: 9,5 cm  
 1007452, 1007454

**NEW TRIA® 95**  
 ANEL, REDONDO,  
 MÓDULO LED

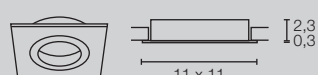

Dimensões de encastramento:  
 Ø: 9,5 cm  
 1007446, 1007448

**NEW TRIA® 95**  
 ANEL, QUADRADO,  
 MÓDULO LED

# CONFIGURE O SEU NEW TRIA®

---

Maior modularidade para maior flexibilidade: com os mais recentes downlights da família NEW TRIA® verá a diversidade estética sob uma nova luz. Só tem de escolher as opções adequadas e beneficie de uma instalação rápida.

## SELECIONE O ARO DE MONTAGEM PREFERIDO ...

- 1 Aplicação  *orientável, rotação e orientação, IP65*  
*Diâmetro de encastramento com 68, 75 e 95 mm*
- 2 Cor  
*preto, branco, rosa dourado ou alumínio*
- 3 redondo ou quadrado

## SELECIONE O MÓDULO FAVORITO ...

- 1 68 / 75 ou 95 mm
- 2 Temperatura de cor  
*2700K ou 3000K, 1800–3000K ou CCT 2500 / 3000 / 4000K*
- 3 Ângulo de abertura  
*38° / 60°*

JÁ ESTÁ!



Tipo de aro



Disponível como versão orientável, rotativa e orientável ou versão IP65 com diâmetro de montagem de 68, 75 e 95



Nas cores preto, branco, rosa dourado ou alumínio



Disponível em redondo ou quadrado

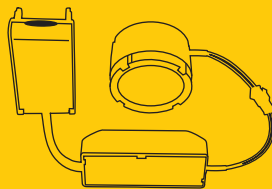

MÓDULO LED



GU10

**NEW TRIA® 68**

**NEW TRIA® 75**

**NEW TRIA® 95**



Temperatura de cor  
2700 / 3000K, DTW 1800 - 3000K ou multi



Ângulo de abertura  
38° / 60°

NEW TRIA® 68  
1007388





## NEW TRIA® Downlight (DL)



NEW

Versão  
GU10



NEW TRIA® 75  
DL, Redondo, QPAR51



NEW TRIA® 68  
DL, Redondo, Phase

Versão  
IP65



NEW TRIA® 68  
DL, Quadrado, Phase



NEW TRIA® 75  
DL, Quadrado, QPAR51

Versão  
DTW



NEW TRIA® 68  
DL, Redondo, DTW,  
Phase

### CONJUNTOS NEW TRIA®

*Todos os conjuntos NEW TRIA® contêm componentes perfeitamente adaptados para uma instalação rápida e fácil. Em qualquer das versões dim-to-warm, multi CCT ou GU10, estará optimamente equipado com a família NEW TRIA®.*

Pode encontrar mais detalhes sobre as medidas e informações de montagem nas páginas 128 e 129

## CONJUNTOS COMPLETOS (ARO + MÓDULO LED)

NEW

### NEW TRIA® 68 DL, Redondo, Phase



220-240V ~50/60Hz  
Material: alumínio

		IP20	200mA	8,3W	2700K	705lm	<b>1007386</b> ●	<b>54,00 EUR</b>
							<b>1007385</b> ●	<b>54,00 EUR</b>
		IP20	200mA	8,3W	3000K	750lm	<b>1007390</b> ●	<b>54,00 EUR</b>
							<b>1007389</b> ●	<b>54,00 EUR</b>



### NEW TRIA® 68 DL, Redondo, Phase



220-240V ~50/60Hz  
Material: alumínio

		IP20	200mA	8,3W	2700K	705lm	<b>1007388</b> ●	<b>54,00 EUR</b>
							<b>1007387</b> ●	<b>54,00 EUR</b>
		IP20	200mA	8,3W	3000K	750lm	<b>1007392</b> ●	<b>54,00 EUR</b>
							<b>1007391</b> ●	<b>54,00 EUR</b>



### NEW TRIA® 68 DL, Quadrado, Phase



220-240V ~50/60Hz  
Material: alumínio

		IP20	200mA	8,3W	2700K	705lm	<b>1007394</b> ●	<b>54,00 EUR</b>
							<b>1007393</b> ●	<b>54,00 EUR</b>
		IP20	200mA	8,3W	3000K	750lm	<b>1007398</b> ●	<b>54,00 EUR</b>
							<b>1007397</b> ●	<b>54,00 EUR</b>



### NEW TRIA® 68 DL, Quadrado, Phase



220-240V ~50/60Hz  
Material: alumínio

		IP20	200mA	8,3W	2700K	705lm	<b>1007396</b> ●	<b>54,00 EUR</b>
							<b>1007395</b> ●	<b>54,00 EUR</b>
		IP20	200mA	8,3W	3000K	750lm	<b>1007400</b> ●	<b>54,00 EUR</b>
							<b>1007399</b> ●	<b>54,00 EUR</b>



Todas as indicações de potência (watts) referem-se à potência total.

Pode encontrar mais detalhes sobre as medidas e informações de montagem nas páginas 146 e 147



### NEW TRIA® 68 DL, Redondo, Phase

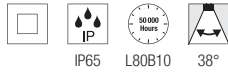

220-240V ~50/60Hz  
Material: alumínio

		IP65	200mA	8,3W	2700K	460lm	1007406	69,00 EUR
		IP65	200mA	8,3W	3000K	530lm	1007405	69,00 EUR
		IP65	200mA	8,3W	3000K	500lm	1007408	69,00 EUR
		IP65	200mA	8,3W	3000K	570lm	1007407	69,00 EUR



### DIM-TO-WARM



### NEW TRIA® 68 DL, Redondo, DTW, Phase



220-240V ~50/60Hz  
Material: alumínio

		IP20	250mA	11W	1800 - 3000K	700lm	1007424	69,00 EUR
		IP20	250mA	11W	1800 - 3000K	700lm	1007423	69,00 EUR



### NEW TRIA® 68 DL, Redondo, DTW, Phase



220-240V ~50/60Hz  
Material: alumínio

		IP20	250mA	11W	1800 - 3000K	700lm	1007426	69,00 EUR
		IP20	250mA	11W	1800 - 3000K	700lm	1007425	69,00 EUR



### NEW TRIA® 68 DL, Quadrado, DTW, Phase



220-240V ~50/60Hz  
Material: alumínio

		IP20	250mA	11W	1800 - 3000K	700lm	1007428	69,00 EUR
		IP20	250mA	11W	1800 - 3000K	700lm	1007427	69,00 EUR



### NEW TRIA® 68 DL, Quadrado, DTW, Phase



220-240V ~50/60Hz  
Material: alumínio

		IP20	250mA	11W	1800 - 3000K	700lm	1007430	69,00 EUR
		IP20	250mA	11W	1800 - 3000K	700lm	1007429	69,00 EUR





# Multi CCT/Multi potência

## NEW TRIA® UNIVERSAL 68 DL, Redondo, Phase



220-240V ~50/60Hz  
Material: alumínio

IP20 100 - 180mA 4,6 - 8,6W CCT 2500 / 3000 / 4000K 540 / 600 / 600lm

1007434 ● 89,00 EUR  
1007433 ● 89,00 EUR



## NEW TRIA® UNIVERSAL 68 DL, Redondo, Phase



220-240V ~50/60Hz  
Material: alumínio

IP20 100 - 180mA 4,6 - 8,6W CCT 2500 / 3000 / 4000K 540 / 600 / 600lm

1007436 ● 89,00 EUR  
1007435 ● 89,00 EUR



## NEW TRIA® UNIVERSAL 68 DL, Quadrado, Phase



220-240V ~50/60Hz  
Material: alumínio

IP20 100 - 180mA 4,6 - 8,6W CCT 2500 / 3000 / 4000K 540 / 600 / 600lm

1007438 ● 89,00 EUR  
1007437 ● 89,00 EUR







### NEW TRIA® UNIVERSAL 68 DL, Quadrado, Phase



220-240V ~50/60Hz  
Material: alumínio



IP20

100 -  
180mA

4,6 - 8,6W

CCT  
2500 / 3000 / 4000K

540 / 600 / 600lm

1007440 ● 89,00 EUR

1007439 ● 89,00 EUR



### NEW TRIA® UNIVERSAL 68 DL, Redondo, Phase

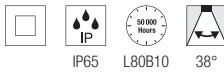

220-240V ~50/60Hz  
Material: alumínio



IP65

100 -  
180mA

4,6 - 8,6W

CCT  
2500 / 3000 / 4000K

370 / 410 / 410lm

430 / 470 / 470lm

1007442 ● 99,00 EUR

1007441 ● 99,00 EUR



### NEW TRIA® 75 DL, Redondo, Phase



220-240V ~50/60Hz  
Material: alumínio



IP20

200mA

8,3W

2700K

705lm

1007402 ● 64,00 EUR

1007401 ● 64,00 EUR

IP20

200mA

8,3W

3000K

750lm

1007404 ● 64,00 EUR

1007403 ● 64,00 EUR



Todas as indicações de potência (watts) referem-se à potência total.

Pode encontrar mais detalhes sobre as medidas e informações de montagem nas páginas 146 e 147

## Conjuntos completos (aro + casquilho GU10)



### NEW TRIA® 68 DL, Redondo, QPAR51



220-240V ~50/60Hz  
Material: alumínio

	-	IP20	-	<10W	1xGU10	-	1007369 ●	19,90 EUR	
	-	IP20	-	<10W	1xGU10	-	1007368 ●	19,90 EUR	
	-	IP20	-	<10W	1xGU10	-	1007370 ●	25,90 EUR	

### NEW TRIA® 68 DL, Quadrado, QPAR51

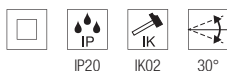

220-240V ~50/60Hz  
Material: alumínio

	-	IP20	-	<10W	1xGU10	-	1007372 ●	19,90 EUR	
	-	IP20	-	<10W	1xGU10	-	1007371 ●	19,90 EUR	
	-	IP20	-	<10W	1xGU10	-	1007373 ●	25,90 EUR	

### NEW TRIA® 75 DL, Redondo, QPAR51



220-240V ~50/60Hz  
Material: alumínio

	-	IP20	-	<10W	1xGU10	-	1007375 ●	25,90 EUR	
	-	IP20	-	<10W	1xGU10	-	1007374 ●	25,90 EUR	
	-	IP20	-	<10W	1xGU10	-	1007376 ●	29,90 EUR	

### NEW TRIA® 75 DL, Quadrado, QPAR51

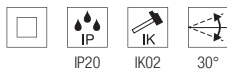

220-240V ~50/60Hz  
Material: alumínio

	-	IP20	-	<10W	1xGU10	-	1007378 ●	25,90 EUR	
	-	IP20	-	<10W	1xGU10	-	1007377 ●	25,90 EUR	
	-	IP20	-	<10W	1xGU10	-	1007379 ●	29,90 EUR	



**NEW TRIA® 75 XL**  
DL, Redondo, QPAR51

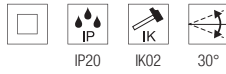

220-240V ~50/60Hz  
Material: alumínio



IP20

-

<10W

1xGU10

-

1007625 ● 30,90 EUR

1007624 ● 30,90 EUR

1007626 ● 34,90 EUR



**NEW TRIA® 75 XL**  
DL, Quadrado, QPAR51

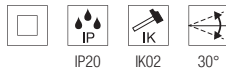

220-240V ~50/60Hz  
Material: alumínio



IP20

-

<10W

1xGU10

-

1007628 ● 30,90 EUR

1007627 ● 30,90 EUR

1007629 ● 34,90 EUR



LED GU10  
38°, Etiqueta energética=F, 6kWh/1000h



6W

2700K

450lm

51 mm

1005077

7,50 EUR



NEW TRIA®  
113890

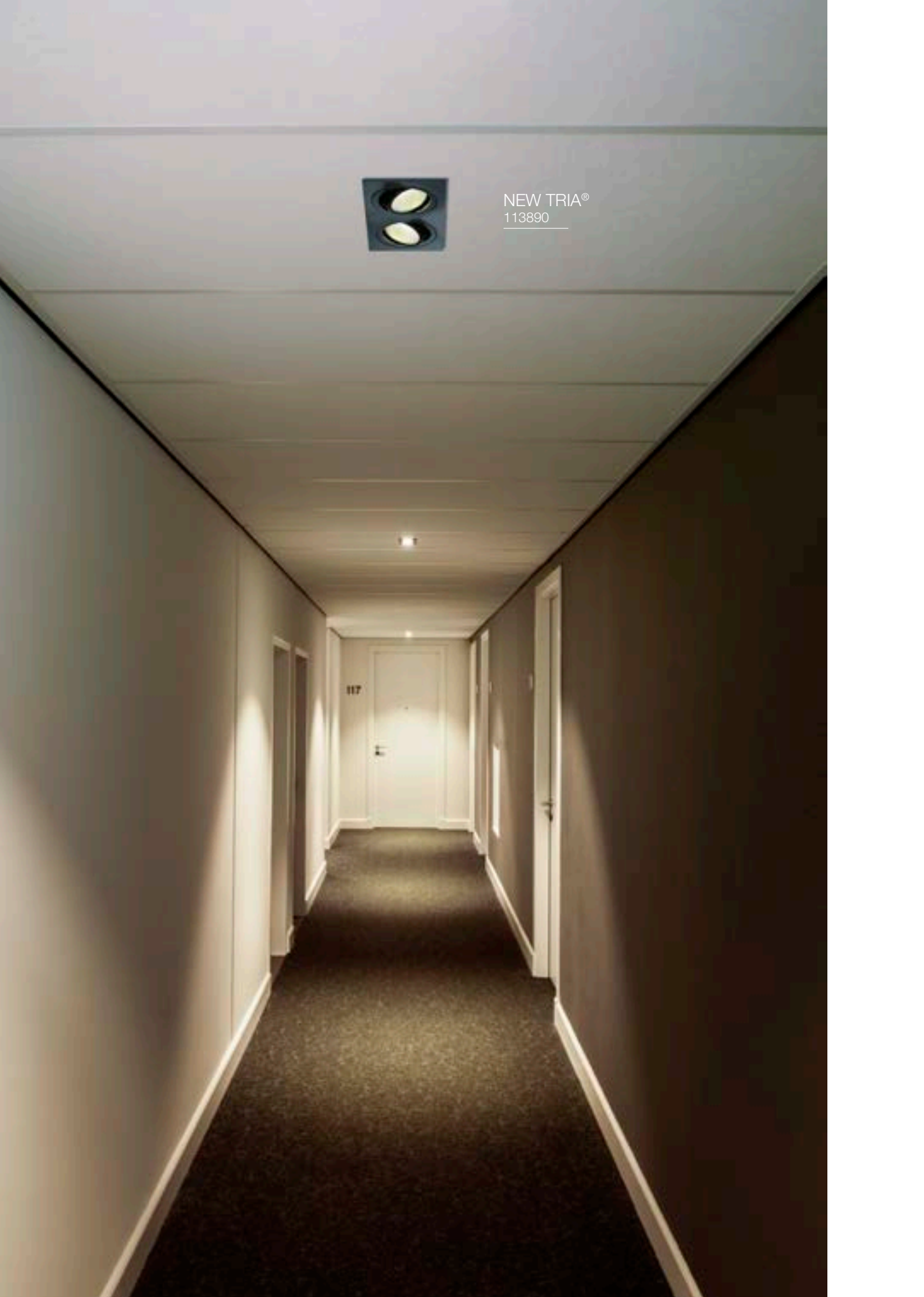



NEW TRIA®  
Downlight (DL)



NEW TRIA® 45  
DL, Redondo

NEW TRIA® 155  
DL, Double



NEW TRIA® 45  
DL, Redondo

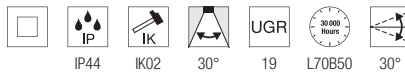

220-240V ~50/60Hz  
Material: alumínio

●	-	IP44	700mA	3,4W	3000K	190lm	113970	53,00 EUR
○	-	IP44	700mA	3,4W	3000K	190lm	113971	53,00 EUR
●	-	IP44	700mA	3,4W	3000K	190lm	113976	60,00 EUR



NEW TRIA® 155  
DL, Double

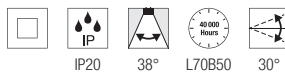

220-240V ~50/60Hz  
Material: alumínio

●	-	IP20	350mA	14W	2700K	1160lm	113890	115,00 EUR
○	-	IP20	350mA	14W	2700K	1160lm	113891	115,00 EUR



Pode encontrar mais detalhes sobre as medidas e informações de montagem nas páginas 146 e 147

NEW TRIA®  
113550

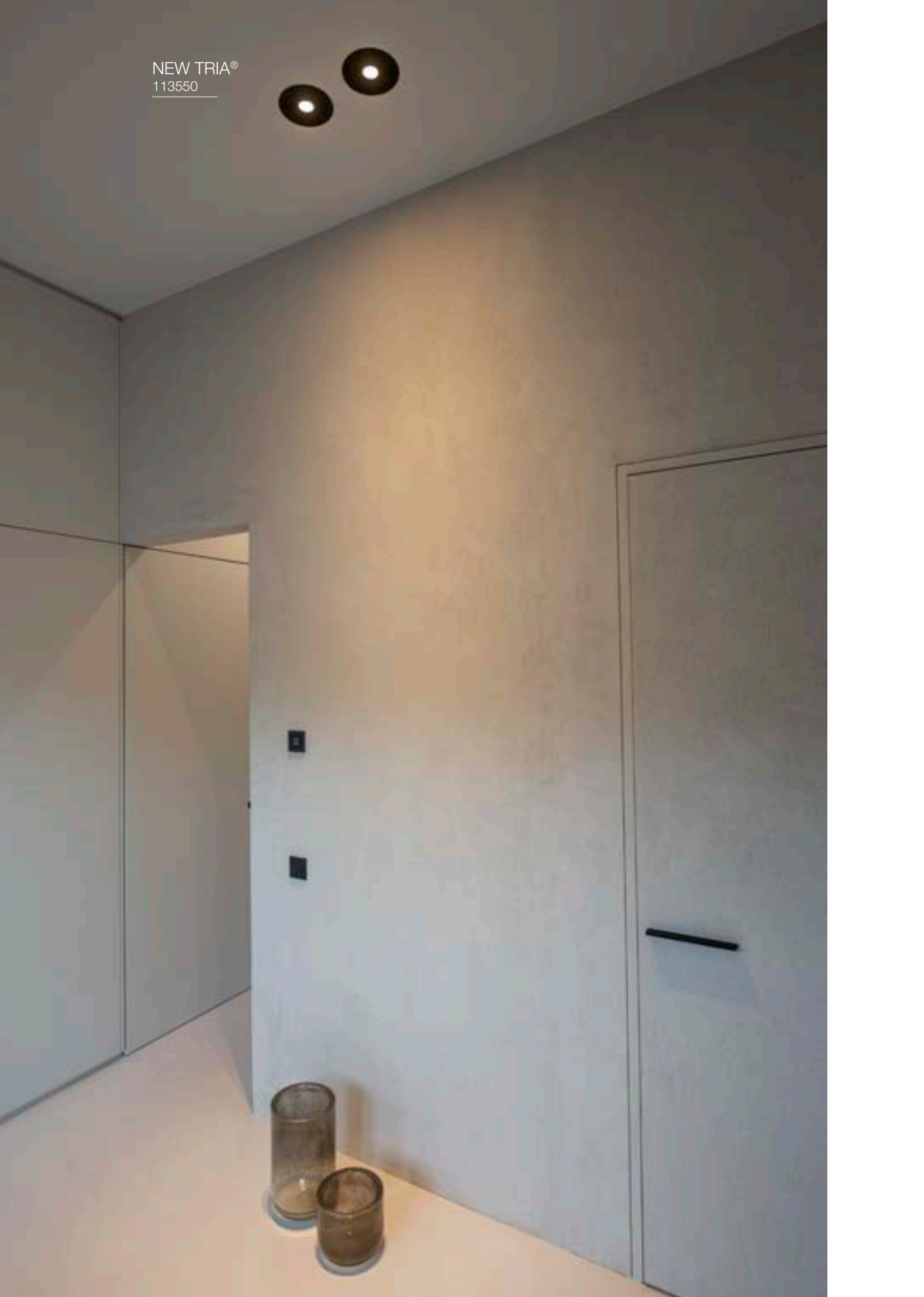



# NEW TRIA® Downlight (DL)

**SOCKET  
INSIDE**

NEW TRIA® 150  
DL, Redondo

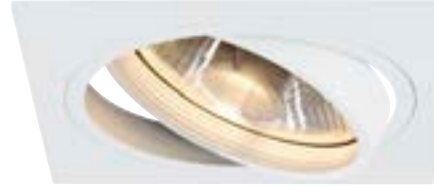

NEW TRIA® 150  
DL, Quadrado



NEW TRIA® 155  
DL, Double



NEW TRIA® 300  
DL, Double



NEW TRIA®  
113840







### NEW TRIA® 150 DL, Redondo, QPAR111

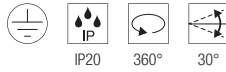

220-240V ~50/60Hz  
Material: alumínio

	-	IP20	-	<75W	1xGU10	-	<b>113550</b>	<b>52,00 EUR</b>
							<b>113540</b>	<b>52,00 EUR</b>



### NEW TRIA® 150 DL, Quadrado, QPAR111

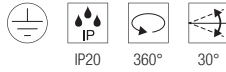

220-240V ~50/60Hz  
Material: alumínio

	-	IP20	-	<75W	1xGU10	-	<b>113830</b>	<b>52,00 EUR</b>
							<b>113541</b>	<b>52,00 EUR</b>



### NEW TRIA® 155 DL, Double, QPAR51

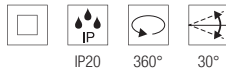

220-240V ~50/60Hz  
Material: alumínio

	-	IP20	-	<50W	2xGU10	-	<b>113492</b>	<b>50,00 EUR</b>
							<b>113512</b>	<b>50,00 EUR</b>
							<b>111362</b>	<b>53,00 EUR</b>



### NEW TRIA® 300 DL, Double, QPAR111

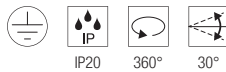

220-240V ~50/60Hz  
Material: alumínio

	-	IP20	-	<75W	2xGU10	-	<b>113840</b>	<b>104,00 EUR</b>
							<b>113841</b>	<b>104,00 EUR</b>
							<b>111382</b>	<b>115,00 EUR</b>



LED GU10 38°, Etiqueta energética=F, 6kWh/1000h Para NEW TRIA® 155		6W	2700K	450lm	51 mm	<b>1005077</b>	<b>7,50 EUR</b>
QPAR111 38°, Etiqueta energética=F, 8kWh/1000h Para NEW TRIA® 150		8W	2700K	680lm	-	<b>1005274</b>	<b>30,75 EUR</b>
LED GU10 40°, Etiqueta energética=G, 8kWh/1000h Para NEW TRIA® 150		7,3W	2700K	500lm	111 mm	<b>1005294</b>	<b>24,50 EUR</b>
QPAR111 30°, Etiqueta energética=F, 13kWh/1000h Para NEW TRIA® 300		12,5W	2700K	950lm	-	<b>1005276</b>	<b>49,50 EUR</b>

# NEW TRIA®

Versão  
IP65

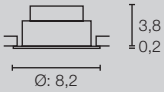

Dimensões de encastramento:  
Ø: 6,8 cm P: 4 cm

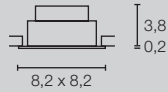

Dimensões de encastramento:  
Ø: 6,8 cm P: 4 cm

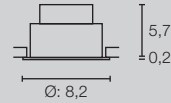

Dimensões de encastramento:  
Ø: 6,8 cm P: 6 cm

## NEW TRIA® 68 DL, REDONDO, PHASE

## NEW TRIA® 68 DL, QUADRADO, PHASE

## NEW TRIA® 68 DL, REDONDO, PHASE

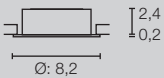

Dimensões de encastramento:  
Ø: 6,8 cm P: 6,5 cm

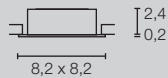

Dimensões de encastramento:  
Ø: 6,8 cm P: 6,5 cm

## NEW TRIA® 68 DL, REDONDO, QPAR51

## NEW TRIA® 68 DL, QUADRADO, QPAR51

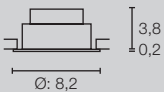

Dimensões de encastramento:  
Ø: 6,8 cm P: 4,5 cm

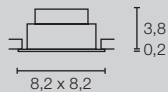

Dimensões de encastramento:  
Ø: 6,8 cm P: 4,5 cm

## NEW TRIA® 68 DL, REDONDO, DTW, PHASE

## NEW TRIA® 68 DL, QUADRADO, DTW, PHASE

Versão  
IP65

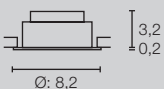

Dimensões de encastramento:  
Ø: 6,8 cm P: 4 cm

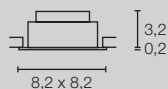

Dimensões de encastramento:  
Ø: 6,8 cm P: 4 cm

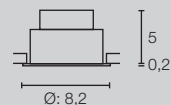

Dimensões de encastramento:  
Ø: 6,8 cm P: 5,5 cm

## NEW TRIA® UNIVERSAL 68 DL, REDONDO, PHASE

## NEW TRIA® UNIVERSAL 68 DL, QUADRADO, PHASE

## NEW TRIA® UNIVERSAL 68 DL, REDONDO, PHASE

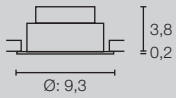

Dimensões de encastramento:  
 Ø: 7,5 cm P: 4 cm

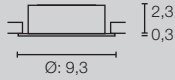

Dimensões de encastramento:  
 Ø: 7,5 cm P: 6,5 cm

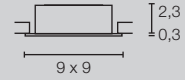

Dimensões de encastramento:  
 Ø: 7,5 cm P: 6,5 cm

**NEW TRIA® 75**  
 DL, REDONDO, PHASE

**NEW TRIA® 75**  
 DL, REDONDO, QPAR51

**NEW TRIA® 75**  
 DL, QUADRADO, QPAR51

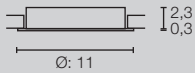

Dimensões de encastramento:  
 Ø: 7,5 cm P: 6,5 cm

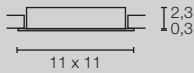

Dimensões de encastramento:  
 Ø: 7,5 cm P: 6,5 cm

**NEW TRIA® 75 XL**  
 DL, REDONDO, QPAR51

**NEW TRIA® 75 XL**  
 DL, QUADRADO, QPAR51

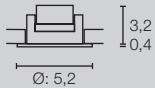

Dimensões de encastramento:  
 Ø: 4,5 cm P: 4 cm

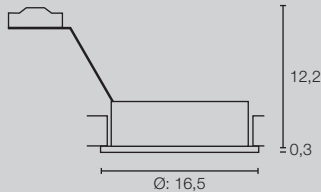

Dimensões de encastramento:  
 Ø: 15 cm P: 12,5 cm

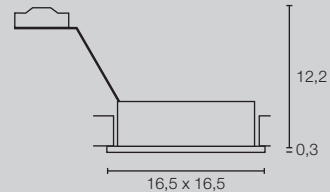

Dimensões de encastramento:  
 Ø: 15 cm P: 12,5 cm

**NEW TRIA® 45**  
 DL, REDONDO

**NEW TRIA® 150**  
 DL, REDONDO, QPAR111

**NEW TRIA® 150**  
 DL, QUADRADO, QPAR111

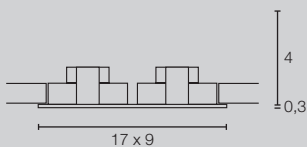

Dimensões de encastramento:  
 C: 15,5, L: 8 cm P: 4 cm

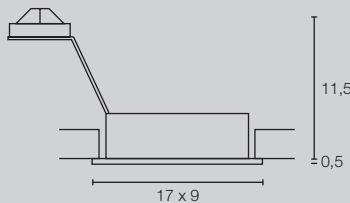

Dimensões de encastramento:  
 C: 15 cm, L: 7,8 cm, P: 12,5 cm

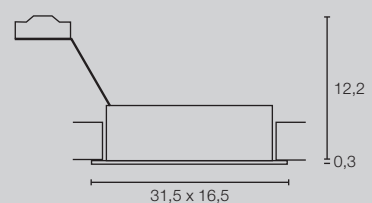

Dimensões de encastramento:  
 C: 30 cm, L: 15,5 cm, P: 12,5 cm

**NEW TRIA® 155**  
 DL, DOUBLE

**NEW TRIA® 155**  
 DL, DOUBLE, QPAR51

**NEW TRIA® 300**  
 DL, DOUBLE, QPAR111

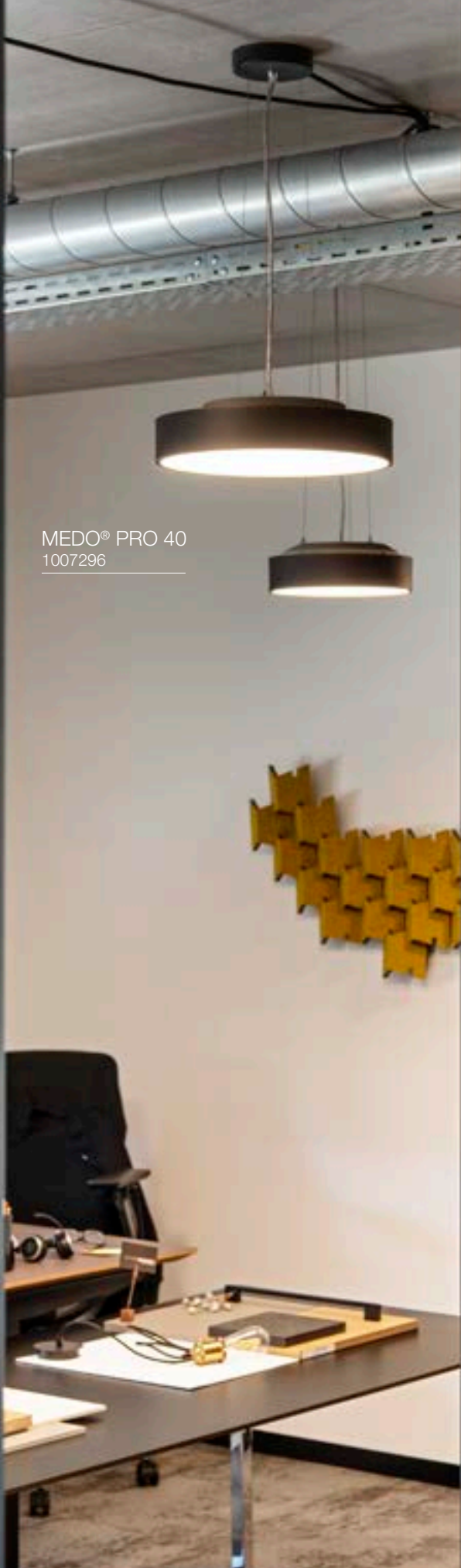

MEDO® PRO 40  
1007296

Descubra a família completa MEDO®



MEDO® PRO CW



MEDO® PRO (DC) CW



MEDO® CW



MEDO® CL



MEDO® RING PD



MEDO® EL

NEW

## MEDO® PRO

Luminárias para parede e teto (CW)



Também disponível com difusor prismático e particularmente sem encadeamento com  $UGR < 19$

Excelente índice de reprodução cromática,  $IRC > 90$

Seleção da temperatura de cor através do interruptor CCT (3000K/4000K)

A parte traseira transparente proporciona uma maior componente de luz indireta



Kit de suspensão não incluído



Particularmente fácil e rápido de instalar, graças ao EasyBase

## ILUMINAÇÃO DE AMBIENTE

*Devido à dispersão indireta das novas luminárias da família MEDO®, a área envolvente à luminária subresai iluminando também o espaço. Criam-se assim ambientes com uma iluminação agradável, uniforme e sem encadeamentos.*



## DISUFOR PRISMÁTICO (UGR<19)

### MEDO® PRO 30 CW, DALI, UGR<19



220-240V ~50/60Hz  
Material: alumínio/poliestireno (PS)

		IP50	250mA	10W	CCT 3000 / 4000K	1250 / 1250lm	<b>1007284</b> ● <b>329,00 EUR</b>	
							<b>1007285</b> ● <b>329,00 EUR</b>	

### MEDO® PRO 30 CW, Phase, UGR<19



220-240V ~50/60Hz  
Material: alumínio/poliestireno (PS)

		IP50	250mA	10W	CCT 3000 / 4000K	1250 / 1250lm	<b>1007288</b> ● <b>299,00 EUR</b>	
							<b>1007289</b> ● <b>299,00 EUR</b>	

### MEDO® PRO 40 CW, DALI, UGR<19



220-240V ~50/60Hz  
Material: alumínio/poliestireno (PS)

		IP50	500mA	19W	CCT 3000 / 4000K	2400 / 2500lm	<b>1007292</b> ● <b>449,00 EUR</b>	
							<b>1007293</b> ● <b>449,00 EUR</b>	

### MEDO® PRO 40 CW, Phase, UGR<19



220-240V ~50/60Hz  
Material: alumínio/poliestireno (PS)

		IP50	500mA	19W	CCT 3000 / 4000K	2400 / 2500lm	<b>1007296</b> ● <b>349,00 EUR</b>	
							<b>1007297</b> ● <b>349,00 EUR</b>	



**MEDO® PRO 60**  
CW, DALI, UGR<19



220-240V ~50/60Hz  
Material: alumínio/poliestireno (PS)

		IP50	1000mA	39W	CCT 3000 / 4000K	5000 / 5100lm	<b>1007300</b> ● <b>699,00 EUR</b>	
							<b>1007301</b> ● <b>699,00 EUR</b>	

**MEDO® PRO 60**  
CW, Phase, UGR<19



220-240V ~50/60Hz  
Material: alumínio/poliestireno (PS)

		IP50	1000mA	37W	CCT 3000 / 4000K	5000 / 5100lm	<b>1007304</b> ● <b>629,00 EUR</b>	
							<b>1007305</b> ● <b>629,00 EUR</b>	

**MEDO® PRO 90**  
CL, DALI, UGR<19



220-240V ~50/60Hz  
Material: alumínio/poliestireno (PS)

		IP50	1000mA	75W	CCT 3000 / 4000K	9400 / 9700lm	<b>1007308</b> ● <b>1.449,00 EUR</b>	
							<b>1007309</b> ● <b>1.449,00 EUR</b>	

**MEDO® PRO 90**  
CL, Phase, UGR<19



220-240V ~50/60Hz  
Material: alumínio/poliestireno (PS)

		IP50	1000mA	74W	CCT 3000 / 4000K	9400 / 9700lm	<b>1007312</b> ● <b>1.249,00 EUR</b>	
							<b>1007313</b> ● <b>1.249,00 EUR</b>	

---

Excelente eficiência energética

## DIFUSOR OPALINO (UGR<25)

### MEDO® PRO 30 CW, DALI



220-240V ~50/60Hz  
Material: alumínio/poliestireno (PS)

		IP50	250mA	10W	CCT 3000 / 4000K	1350 / 1350lm	1007286 ● 329,00 EUR	
							1007287 ● 329,00 EUR	

### MEDO® PRO 30 CW, Phase



220-240V ~50/60Hz  
Material: alumínio/poliestireno (PS)

		IP50	250mA	10W	CCT 3000 / 4000K	1350 / 1350lm	1007290 ● 299,00 EUR	
							1007291 ● 299,00 EUR	

### MEDO® PRO 40 CW, DALI



220-240V ~50/60Hz  
Material: alumínio/poliestireno (PS)

		IP50	500mA	19W	CCT 3000 / 4000K	2650 / 2650lm	1007294 ● 449,00 EUR	
							1007295 ● 449,00 EUR	

### MEDO® PRO 40 CW, Phase



220-240V ~50/60Hz  
Material: alumínio/poliestireno (PS)

		IP50	500mA	19W	CCT 3000 / 4000K	2650 / 2650lm	1007298 ● 349,00 EUR	
							1007299 ● 349,00 EUR	







### MEDO® PRO 60 CW, DALI



220-240V ~50/60Hz  
Material: alumínio/poliestireno (PS)

		IP50	1000mA	39W	CCT 3000 / 4000K	5450 / 5500lm	<b>1007302</b> ● 699,00 EUR	
							<b>1007303</b> ● 699,00 EUR	

### MEDO® PRO 60 CW, Phase



220-240V ~50/60Hz  
Material: alumínio/poliestireno (PS)

		IP50	1000mA	37W	CCT 3000 / 4000K	5450 / 5500lm	<b>1007306</b> ● 629,00 EUR	
							<b>1007307</b> ● 629,00 EUR	

### MEDO® PRO 90 CL, DALI



220-240V ~50/60Hz  
Material: alumínio/poliestireno (PS)

		IP50	1000mA	75W	CCT 3000 / 4000K	11000 / 11200lm	<b>1007310</b> ● 1.449,00 EUR	
							<b>1007311</b> ● 1.449,00 EUR	

### MEDO® PRO 90 CL, Phase



220-240V ~50/60Hz  
Material: alumínio/poliestireno (PS)

		IP50	1000mA	74W	CCT 3000 / 4000K	11000 / 11200lm	<b>1007314</b> ● 1.249,00 EUR	
							<b>1007315</b> ● 1.249,00 EUR	



	Preto	135250	44,75 EUR
Kit de suspensão 1,5 m	Branco	135251	44,75 EUR
	Cinzento	135254	44,75 EUR
	Preto	1001952	99,00 EUR
Kit de suspensão 5 m	Branco	1001950	99,00 EUR
	Cinzento	1001951	99,00 EUR

MEDO® PRO 60  
1006417 (DC)

MEDO® PRO 40  
1006414 (DC)



## ILUMINAÇÃO DE AMBIENTE

*Devido à dispersão indireta das novas luminárias da família MEDO®, a área envolvente à luminária subresai iluminando também o espaço. Criam-se assim ambientes com uma iluminação agradável, uniforme e sem encadeamentos.*

MEDO® PRO  
Luminárias para parede e teto (CW),  
DC



NEW

Kit de suspensão não incluído



Particularmente fácil  
e rápido de instalar,  
graças ao EasyBase



Com difusor prismático  
e particularmente sem  
encadeamento com UGR<19

A parte traseira transparente  
proporciona uma maior  
componente de luz indireta

Excelente índice de reprodução  
cromática, IRC>90



## ILUMINAÇÃO DE EMERGÊNCIA

*Com MEDO® PRO DC, pode desfrutar de todas as vantagens técnicas da versão prismática MEDO® PRO com UGR<19. Graças ao controlador integrado com capacidade DC, pode ter a certeza de que as luminárias também são adequadas para funcionamento com energia de emergência e continuarão a iluminar o seu caminho.*

MEDO® PRO 60  
1006417 (DC)

MEDO® PRO 30  
1006411 (DC)



Encontre ainda mais  
ideias na nossa  
brochura MEDO®



### MEDO® PRO 30 CW, DALI, UGR<19, DC



220-240V ~50/60Hz  
Material: alumínio/poliestireno (PS)

		IP50	250mA	10W	CCT 3000 / 4000K	1250 / 1250lm	<b>1006411</b> ● <b>379,00 EUR</b>
							<b>1006412</b> ● <b>379,00 EUR</b>



### MEDO® PRO 40 CW, DALI, UGR<19, DC



220-240V ~50/60Hz  
Material: alumínio/poliestireno (PS)

		IP50	500mA	19W	CCT 3000 / 4000K	2400 / 2500lm	<b>1006414</b> ● <b>449,00 EUR</b>
							<b>1006415</b> ● <b>449,00 EUR</b>



### MEDO® PRO 60 CW, DALI, UGR<19, DC



220-240V ~50/60Hz  
Material: alumínio/poliestireno (PS)

		IP50	1000mA	37W	CCT 3000 / 4000K	5000 / 5100lm	<b>1006417</b> ● <b>749,00 EUR</b>
							<b>1006418</b> ● <b>749,00 EUR</b>



### MEDO® PRO 90 CL, DALI, UGR<19, DC



220-240V ~50/60Hz  
Material: alumínio/poliestireno (PS)

		IP50	1000mA	75W	CCT 3000 / 4000K	9400 / 9700lm	<b>1006420</b> ● <b>1.549,00 EUR</b>
							<b>1006421</b> ● <b>1.549,00 EUR</b>



Kit de suspensão 1,5 m	Preto	135250	44,75 EUR
	Branco	135251	44,75 EUR
	Cinzeno	135254	44,75 EUR
Kit de suspensão 5 m	Preto	1001952	99,00 EUR
	Branco	1001950	99,00 EUR
	Cinzeno	1001951	99,00 EUR

MEDO® 60  
1007322

MEDO® 90  
1007325



## ILUMINAÇÃO DE AMBIENTE

*Devido à dispersão indireta das novas luminárias da família MEDO®, a área envolvente à luminária subresai iluminando também o espaço. Criam-se assim ambientes com uma iluminação agradável, uniforme e sem encadeamentos.*



MEDO®  
Luminárias para parede e teto (CW)



NEW

Kit de suspensão não incluído

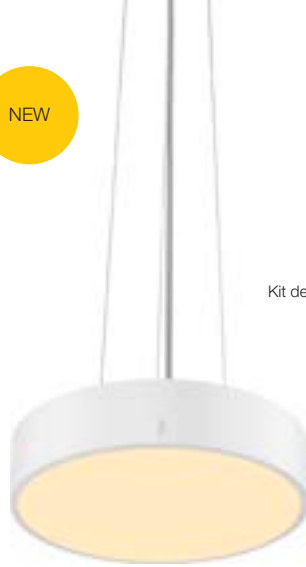

Particularmente fácil  
e rápido de instalar,  
graças ao EasyBase

Excelente índice de reprodução  
cromática, IRC>90

Seleção da temperatura de  
cor através do interruptor CCT  
(2700K/3000K/4000K)

A parte traseira transparente  
proporciona uma maior  
componente de luz indireta



MEDO® 30  
1007317







### MEDO® 30 CW, Phase



220-240V ~50/60Hz  
Material: alumínio/poliestireno (PS)



IP50 250mA 12W CCT 2700 / 3000 / 4000K 1050 / 1100 / 1200lm

1007316 ● 265,00 EUR  
1007317 ● 265,00 EUR  
1007318 ● 265,00 EUR



### MEDO® 40 CW, Phase



220-240V ~50/60Hz  
Material: alumínio/poliestireno (PS)



IP50 500mA 20W CCT 2700 / 3000 / 4000K 2100 / 2200 / 2350lm

1007319 ● 294,00 EUR  
1007320 ● 294,00 EUR  
1007321 ● 294,00 EUR



### MEDO® 60 CW, Phase



220-240V ~50/60Hz  
Material: alumínio/poliestireno (PS)



IP50 1000mA 39W CCT 2700 / 3000 / 4000K 4050 / 4250 / 4550lm

1007322 ● 559,00 EUR  
1007323 ● 559,00 EUR  
1007324 ● 559,00 EUR



### MEDO® 90 CL, Phase



220-240V ~50/60Hz  
Material: alumínio/poliestireno (PS)



IP50 1000mA 79W CCT 2700 / 3000 / 4000K 8300 / 8700 / 9350lm

1007325 ● 1.099,00 EUR  
1007326 ● 1.099,00 EUR  
1007327 ● 1.099,00 EUR



Kit de suspensão 1,5 m	Preto	135250	44,75 EUR
	Branco	135251	44,75 EUR
	Cinzeno	135254	44,75 EUR
Kit de suspensão 5 m	Preto	1001952	99,00 EUR
	Branco	1001950	99,00 EUR
	Cinzeno	1001951	99,00 EUR

# MEDO®:

# COMO INSTALAR

---

As novas versões da família MEDO® são fáceis e rápidas de instalar graças ao nosso EasyBase. Utilize o EasyBase diretamente como modelo para os furos e fixe-o diretamente depois de os aparafusar. Em seguida, basta selecionar a temperatura de cor através do interruptor CCT na luminária, prestar atenção às marcações verdes e facilmente encaixe a luminária.

## LUMINÁRIAS SALIENTES PARA TETO

Aparafuse o EasyBase ao teto



Ligue o EasyBase



Selecione a temperatura de cor através do interruptor CCT e encaixe a luminária, tendo em atenção as marcações verdes.

As luminárias MEDO® 60 e MEDO® 90 necessitam também da ligação da corrente de segurança (incluída).

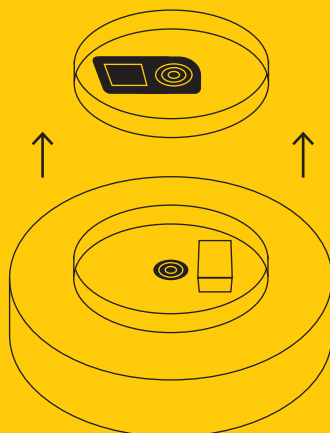

Particularmente  
fácil e rápido  
de instalar, graças  
ao EasyBase

## ENCASTRAR SEM ARO

## ENCASTRAR COM ARO

Colocar kit de encastramento no teto

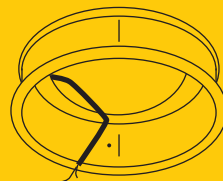

Posicionar as placas de montagem

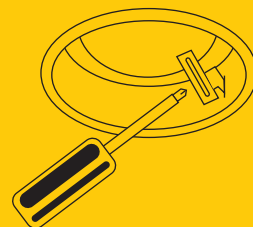
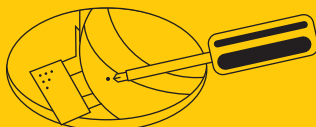

Aparafusar placa de montagem  
ao teto e selar o teto



Ligar o driver (controlador do LED)

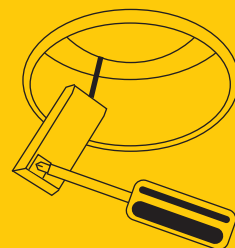
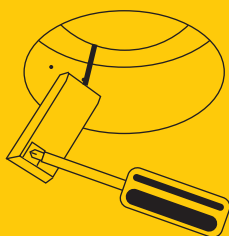

Inserir o módulo LED e selecionar  
a temperatura de cor através do  
interruptor CCT

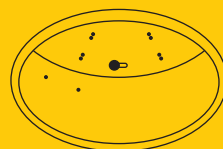

Colocar o difusor

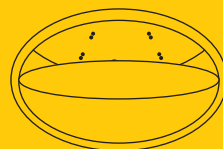

MEDO® 60  
1002882

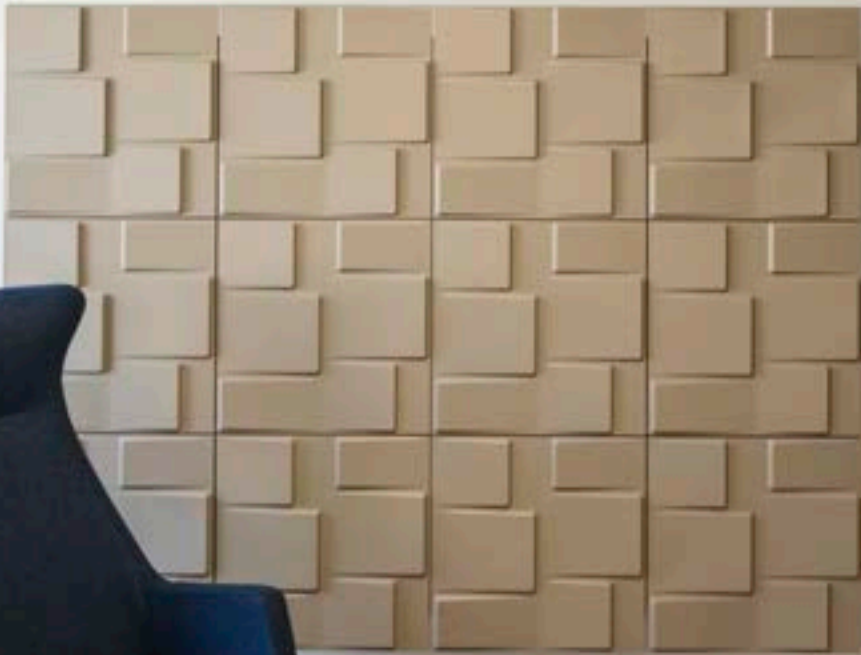
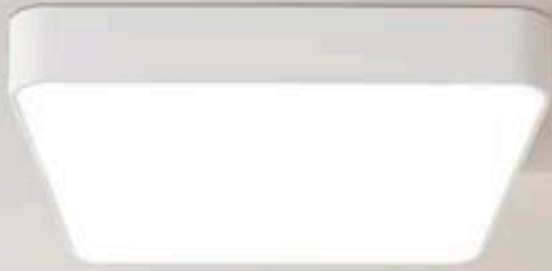



MEDO®  
Luminárias para teto (CL)



Kit de suspensão não incluído



MEDO® 60  
CL, Quadrado, 1-10V



220-240V ~50/60Hz  
Material: alumínio/acrílico

		IP20	1000mA	39W	3000K	3800lm	1000726	499,00 EUR	
--	--	------	--------	-----	-------	--------	---------	------------	--

MEDO® 60  
CL, Quadrado, DALI



220-240V ~50/60Hz  
Material: alumínio/acrílico

		IP20	1000mA	39W	3000K	3800lm	1002882	549,00 EUR	
--	--	------	--------	-----	-------	--------	---------	------------	--

⊕			
Kit de suspensão 1,5 m	Preto	135250	44,75 EUR
	Branco	135251	44,75 EUR
	Cinzeno	135254	44,75 EUR
Kit de suspensão 5 m	Preto	1001952	99,00 EUR
	Branco	1001950	99,00 EUR
	Cinzeno	1001951	99,00 EUR



MEDO® RING 60  
133840

---





## MEDO® RING

Luminárias suspensas (PD)



MEDO® RING  
Com as dimensões 60 e 90

### MEDO® RING 60 PD, 1-10V

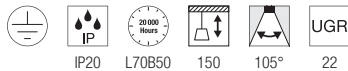

220-240V ~50/60Hz  
Material: alumínio/polimetilacrilato (PMMA)

		IP20	700mA	33W	3000K	2200lm
						

133840	699,00 EUR
133841	699,00 EUR



### MEDO® RING 90 PD, 1-10V

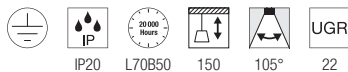

220-240V ~50/60Hz  
Material: alumínio/polimetilacrilato (PMMA)

		IP20	1200mA	56W	3000K	4900lm
						

133850	869,00 EUR
133851	869,00 EUR



### MEDO® RING 60 PD, DALI

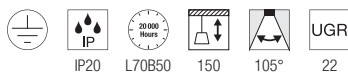

220-240V ~50/60Hz  
Material: alumínio/polimetilacrilato (PMMA)

		IP20	700mA	34W	3000K	2200lm
						

1002890	729,00 EUR
1002891	729,00 EUR



MEDO® 60  
1001907

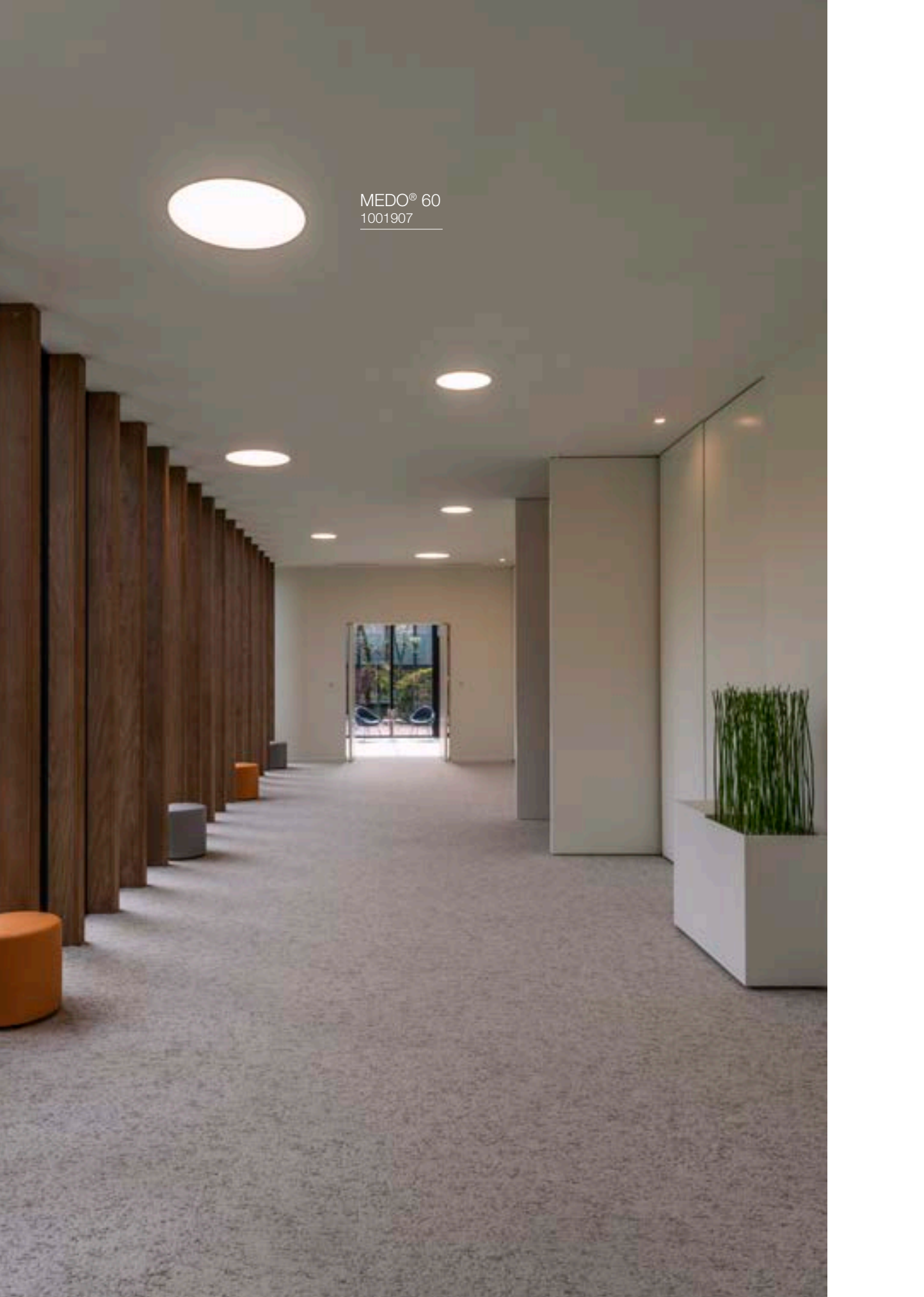





## MEDO® Luminárias para encastrar (EL)



MEDO® 30, 40 e 60  
EL, sem aro de remate



Seleção da temperatura de cor através do interruptor CCT (3000K/4000K)



MEDO® 30, 40 e 60  
EL, caixa de montagem para encastrar



## SEM ARO DE REMATE

### MEDO® 30 EL, Sem moldura



Material: alumínio/polimetilacrilato (PMMA)

○ - IP20 350mA 14W CCT 3000 / 4000K 1500 / 1600lm **1001901 209,00 EUR**



### MEDO® 40 EL, Sem moldura



Material: alumínio/polimetilacrilato (PMMA)

○ - IP20 700mA 28W CCT 3000 / 4000K 3100 / 3300lm **1001902 235,00 EUR**



### MEDO® 60 EL, Sem moldura



Material: alumínio/polimetilacrilato (PMMA)

○ - IP20 1000 / 1050mA 36W CCT 3000 / 4000K 4700 / 5000lm **1001903 499,00 EUR**



Os controladores LED (driver)  
não estão incluídos e estão  
disponíveis em separado.  
Pode encontrar o controlador  
adequado aqui:





## CAIXA DE MONTAGEM PARA ENCASTRAR

### MEDO® 30 EL, Caixa de montagem para encastrar

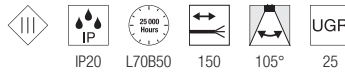

Material: alumínio/polimetilacrilato (PMMA)

○ - IP20 350mA 14W CCT 3000 / 4000K 1500 / 1600lm **1001905** **219,00 EUR**



### MEDO® 40 EL, Caixa de montagem para encastrar



Material: alumínio/polimetilacrilato (PMMA)

○ - IP20 700mA 28W CCT 3000 / 4000K 3100 / 3300lm **1001906** **249,00 EUR**



### MEDO® 60 EL, Caixa de montagem para encastrar

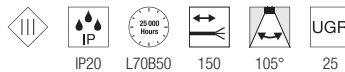

Material: alumínio/polimetilacrilato (PMMA)

○ - IP20 1000 / 1050mA 38W CCT 3000 / 4000K 4700 / 5000lm **1001907** **549,00 EUR**



## CONTROLADOR LED



CONTROLADOR LED (DRIVER) 250-700mA, 1-10V / DALI INCL. ALÍVIO DE TENSÃO MEDO® 30 + 60	Branco	20W	1-10V / DALI	C: 15 cm, L: 5,2 cm, A: 2,8 cm	<b>1002423</b>	<b>85,00 EUR</b>
CONTROLADOR LED (DRIVER) 500-1050mA, 1-10V / DALI INCL. ALÍVIO DE TENSÃO MEDO® 40	Branco	40W	1-10V / DALI	C: 14,2 cm, L: 4,4 cm, A: 3 cm	<b>1002424</b>	<b>90,00 EUR</b>
CONTROLADOR LED (DRIVER) 700mA INCL. ALÍVIO DE TENSÃO MEDO® 40	Branco	40W	C	C: 14,5 cm, L: 4 cm, A: 3 cm	<b>1005446</b>	<b>45,00 EUR</b>
CONTROLADOR LED (DRIVER) 1050mA INCL. ALÍVIO DE TENSÃO MEDO® 30 + 60	Branco	40W	C	C: 16,6 cm, L: 5,2 cm, A: 2,4 cm	<b>464804</b>	<b>57,00 EUR</b>
CONTROLADOR LED (DRIVER) 700 / 900 / 1000mA INCL. ALÍVIO DE TENSÃO MEDO® 30 + 40 + 60	Branco	40W	-	C: 12,3 cm, L: 7,9 cm, A: 3 cm	<b>1006120</b>	<b>57,00 EUR</b>

# MEDO®

---



**MEDO® PRO**  
CW

**MEDO® PRO (DC)**  
CW

**MEDO®**  
CW

Dimensões	<b>30   40   60   90</b>	<b>30   40   60   90</b>	<b>30   40   60   90</b>
Conjunto de suspensão	1,5   5 m (excl.)	1,5   5 m (excl.)	1,5   5 m (excl.)
EasyBase	✓	✓	✓
Interruptor CCT	✓	✓	✓
DALI	✓	✓	-
Regulação em fase	C	-	C
1-10 V	-	-	-
UGR	19   25	19	22   25
DC	-	✓	-

Os drivers (controladores) não estão incluídos e deverão ser encomendados separadamente



**MEDO®**  
CL, QUADRADO

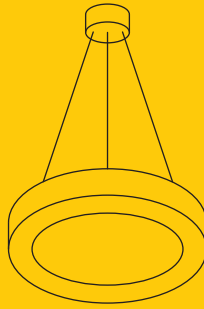

**MEDO® RING**  
PD

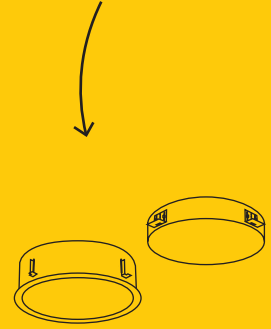

**MEDO®**  
EL, SEM ARO DE REMATE | CAIXA PARA ENCASTRAR

	<b>60</b>	<b>60</b>	<b>30   40   60</b>
	1,5   5 m (excl.)	1,5 m (inc.)	-
	-	-	-
	-	-	✓
	✓	✓	✓ *
	-	-	✓ *
	✓	✓	✓ *
	22	22	25
	-	-	-

\*Necessita de driver

# MEDO®

## LUMINÁRIAS PARA ENCASTRAR NO TETO

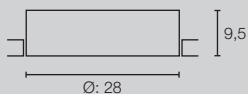

Dimensões de montagem:  
Ø: 29 cm P: 13 cm

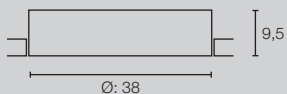

Dimensões de montagem:  
Ø: 39 cm P: 13 cm

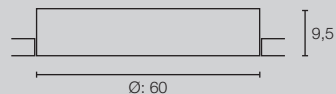

Dimensões de montagem:  
Ø: 61 cm P: 16 cm

### MEDO® 30

EL, SEM ARO DE REMATE

### MEDO® 40

EL, SEM ARO DE REMATE

### MEDO® 60

EL, SEM ARO DE REMATE

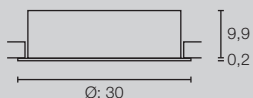

Dimensões de montagem:  
Ø: 29 cm P: 13 cm

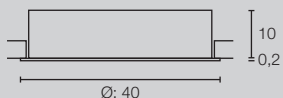

Dimensões de montagem:  
Ø: 39 cm P: 13 cm

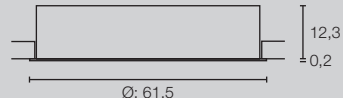

Dimensões de montagem:  
Ø: 61 cm P: 16 cm

### MEDO® 30

EL, CAIXA DE MONTAGEM PARA ENCASTRAR

### MEDO® 40

EL, CAIXA DE MONTAGEM PARA ENCASTRAR

### MEDO® 60

EL, CAIXA DE MONTAGEM PARA ENCASTRAR

## LUMINÁRIA SALIENTE PARA TETO

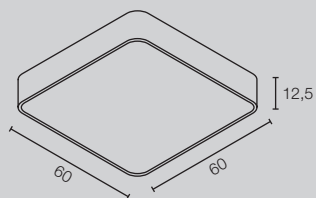

**MEDO® 60**  
CL, QUADRADO

## LUMINÁRIAS SUSPENSAS

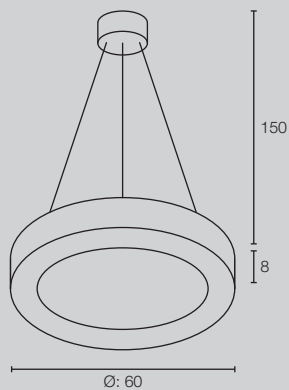

**MEDO® RING 60**  
PD

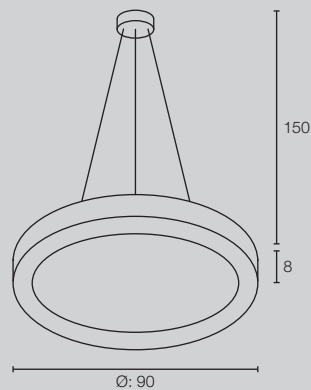

**MEDO® RING 90**  
PD



Todas as luminárias salientes para o teto também podem ser instaladas como luminárias suspensas.

## LUMINÁRIAS PARA PAREDE E TETO

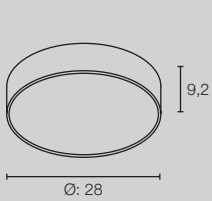

**MEDO® PRO 30**  
CW, DC

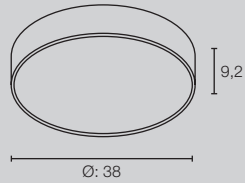

**MEDO® PRO 40**  
CW, DC

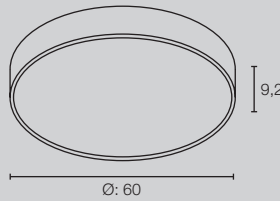

**MEDO® PRO 60**  
CW, DC

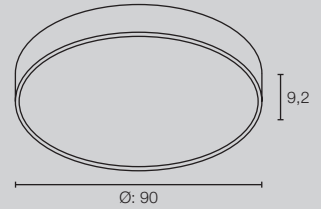

**MEDO® PRO 90**  
CL, DC

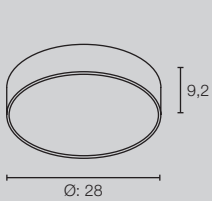

**MEDO® PRO 30**  
CW

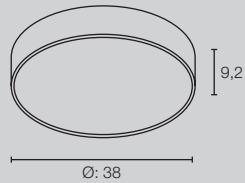

**MEDO® PRO 40**  
CW

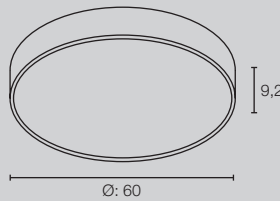

**MEDO® PRO 60**  
CW

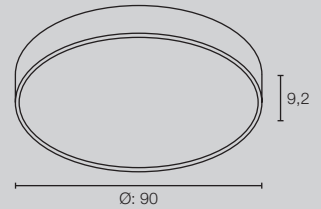

**MEDO® PRO 90**  
CL

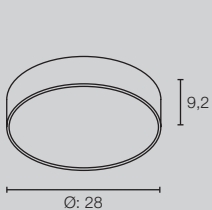

**MEDO® 30**  
CW

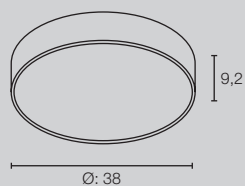

**MEDO® 40**  
CW

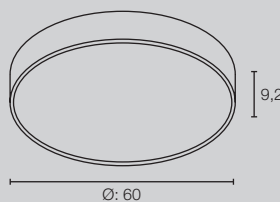

**MEDO® 60**  
CW

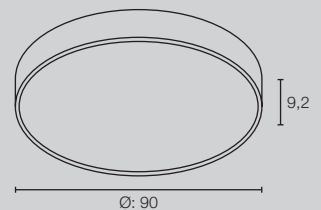

**MEDO® 90**  
CL

LALU®  
1007550







LALU®  
Luminárias suspensas (PD)

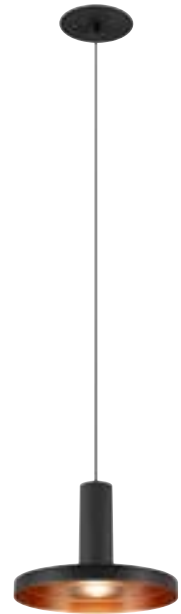
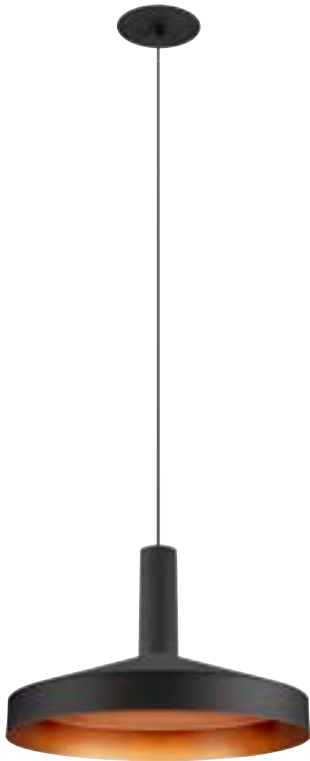

Combine as cores e os formatos das luminárias suspensas LALU®

LALU®  
PD, LED Base, Phase



220-240V ~50/60Hz  
Material: alumínio/aço

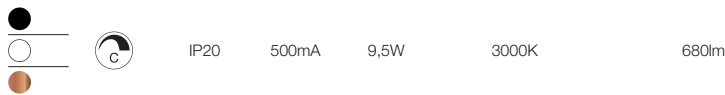

IP20 500mA 9,5W 3000K 680lm



- 1007518 ● 169,00 EUR
- 1007519 ● 169,00 EUR
- 1007520 ● 175,00 EUR

LALU®  
PD, LED Base, Phase, Recessed



220-240V ~50/60Hz  
Material: alumínio/aço

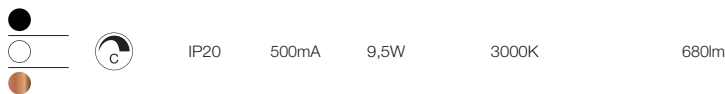

IP20 500mA 9,5W 3000K 680lm



- 1007548 ● 149,00 EUR
- 1007549 ● 149,00 EUR
- 1007550 ● 155,00 EUR

## SELECIONE O RESPETIVO ABAJUR (SHADE)



LALU® TETRA 14	preto/bronze antigo	IP20	Ø: 14 cm, A: 4,9 cm	1007523	55,00 EUR			
	Branco/dourado			1007522	55,00 EUR			
	Bronze antigo			1007521	58,00 EUR			
LALU® TETRA 24	preto/bronze antigo	IP20	Ø: 24 cm, A: 6,7 cm	1007526	72,00 EUR			
	Branco/dourado			1007525	72,00 EUR			
	Bronze antigo			1007524	78,00 EUR			
LALU® TETRA 36	preto/bronze antigo	IP20	Ø: 36 cm, A: 8,9 cm	1007529	114,00 EUR			
	Branco/dourado			1007528	114,00 EUR			
	Bronze antigo			1007527	126,00 EUR			
LALU® CONE 15	preto/bronze antigo	-	Ø: 15,2 cm, A: 17 cm	1007532	57,00 EUR			
	Branco/dourado			1007531	57,00 EUR			
	Bronze antigo			1007530	65,00 EUR			
LALU® ELYPSE 15	preto/bronze antigo	-	Ø: 15 cm, A: 1,4 cm	1007535	36,00 EUR			
	Branco/dourado			1007534	36,00 EUR			
	Bronze antigo			1007533	42,00 EUR			
LALU® ELYPSE 22	preto/bronze antigo	-	Ø: 22 cm, A: 2,8 cm	1007538	57,00 EUR			
	Branco/dourado			1007537	57,00 EUR			
	Bronze antigo			1007536	65,00 EUR			
LALU® ELYPSE 33	preto/bronze antigo	-	Ø: 33 cm, A: 3,5 cm	1007541	89,00 EUR			
	Branco/dourado			1007540	89,00 EUR			
	Bronze antigo			1007539	95,00 EUR			
LALU® PLATE 15	preto/bronze antigo	-	Ø: 15 cm, A: 1,5 cm	1007544	42,00 EUR			
	Branco/dourado			1007543	42,00 EUR			
	Bronze antigo			1007542	45,00 EUR			
LALU® PLATE 22	preto/bronze antigo	-	Ø: 22 cm, A: 1,5 cm	1007547	55,00 EUR			
	Branco/dourado			1007546	55,00 EUR			
	Bronze antigo			1007545	59,00 EUR			



# MIX & MATCH

## LALU®

---

### LALU® TETRA 14

Preto | 1007523  
Branco | 1007522  
Bronze antigo | 1007521



### LALU® CONE 15

Preto | 1007532  
Branco | 1007531  
Bronze antigo | 1007530

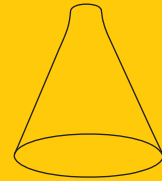

### LALU® TETRA 24

Preto | 1007526  
Branco | 1007525  
Bronze antigo | 1007524



### LALU® TETRA 36

Preto | 1007529  
Branco | 1007528  
Bronze antigo | 1007527



### LALU®

*PD, LED BASE, PHASE*

Preto | 1007518  
Branco | 1007519  
Bronze antigo | 1007520



### LALU®

*PD, LED BASE, PHASE, RECESSED*

Preto | 1007548  
Branco | 1007549  
Bronze antigo | 1007550



### LALU® ELYPSE 15

Preto	1007535
Branco	1007534
Bronze antigo	1007533



### LALU® PLATE 15

Preto	1007544
Branco	1007543
Bronze antigo	1007542



### LALU® ELYPSE 22

Preto	1007538
Branco	1007537
Bronze antigo	1007536



### LALU® PLATE 22

Preto	1007547
Branco	1007546
Bronze antigo	1007545



### LALU® ELYPSE 33

Preto	1007541
Branco	1007540
Bronze antigo	1007539



### LALU®

*PD, LED BASE, 48V, DALI*

Preto	1007749
Branco	1007748
Bronze antigo	1007747



Combine os produtos da gama LALU® de acordo com as suas preferências. Perfeitamente coordenadas, pode combinar formatos, tamanhos e cores e criar a sua luminária a partir de várias opções. Seja criativo – Identifique os produtos SLV Mix & Match pelo símbolo seguinte:



**MIX**  
match

LALU®  
1007653





LALU®  
Luminária suspensa (PD)

SOCKET  
INSIDE



LALU®  
PD, E27



IP20

150

220-240V ~50/60Hz  
Material: alumínio

● - IP20 - 10W 1xE27 - 1007658 ● 149,00 EUR



LALU®  
Shade, E27 Base

preto/bronze antigo

Ø: 33 cm, A: 3,5 cm

1007659 ● 149,00 EUR

Bronze antigo

1007660 ● 169,00 EUR



A60  
180°, Etiqueta energética=F, 8kWh/1000h



7,5W

2700K

720lm

-

1005305

19,00 EUR

## LUMINÁRIAS SUSPENSAS

MIX  
match



**LALU® TETRA 14**  
PD, SHADE

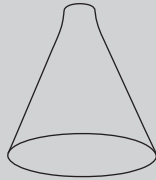

**LALU® CONE 15**  
PD, SHADE



**LALU® ELYPSE 15**  
PD, SHADE



**LALU® PLATE 15**  
PD, SHADE



**LALU® TETRA 24**  
PD, SHADE



**LALU® ELYPSE 22**  
PD, SHADE



**LALU® PLATE 22**  
PD, SHADE

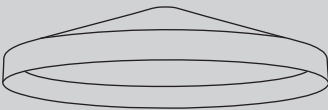

**LALU® TETRA 36**  
PD, SHADE



**LALU® ELYPSE 33**  
PD, SHADE

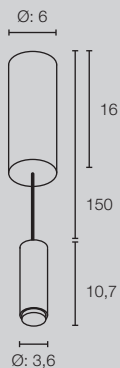

**LALU®**  
PD, LED BASE, PHASE

Dimensões de encastramento:  
Ø: 6,8 cm P: 5 cm

**LALU®**  
PD, LED BASE, PHASE, RECESSED

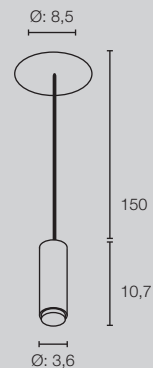

Ø: 3,6



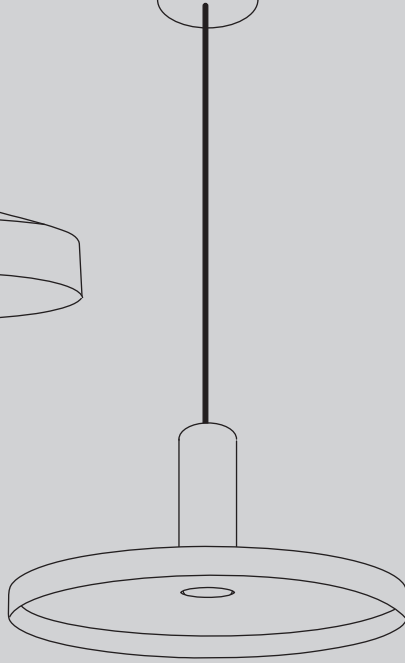
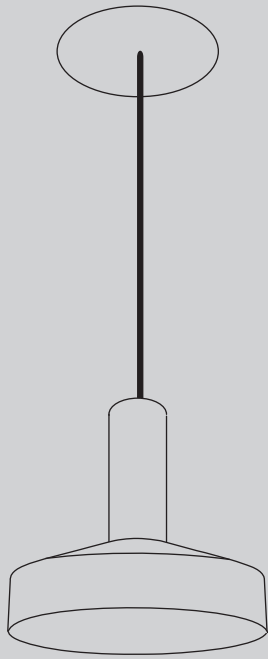

LALU®  
PD, SHADE

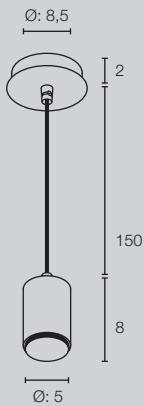

LALU®  
PD, E27

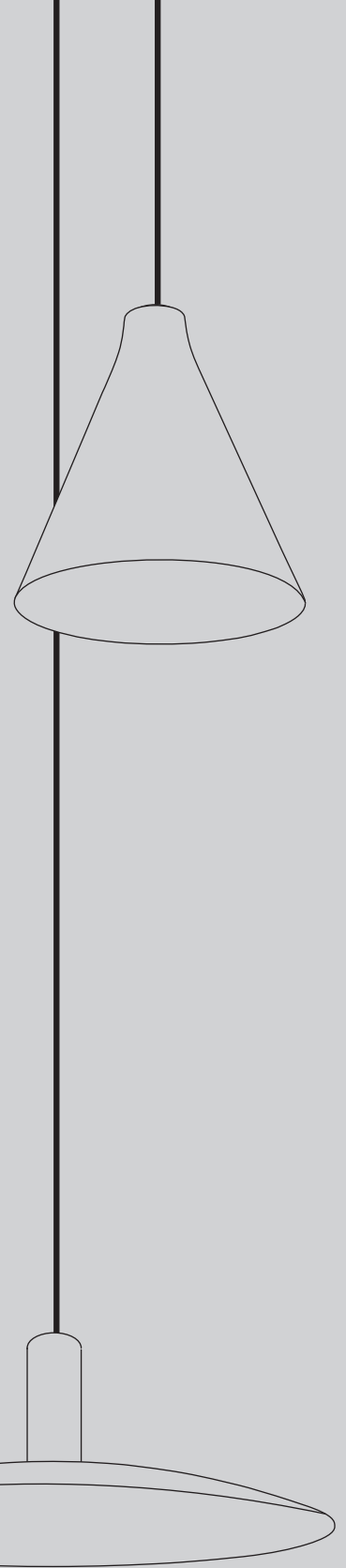

ONE® 60  
1005177





ONE®  
Luminárias suspensas (PD)



ONE® TRIPLE DALI



ONE® 60 DALI



ONE® DOUBLE  
PD DALI UP/DOWN



ONE® CUBE  
DALI UP/DOWN

## ONE® 60 PD, Dali



220-240V ~50/60Hz  
Material: alumínio/aço

		IP20	600mA	24W	CCT 3000 / 4000K	1480 / 1550lm	<b>1002909</b>	<b>423,00 EUR</b>	
	2.0						<b>1002910</b>	<b>423,00 EUR</b>	

## ONE® 60 PD, Up/Down, Dali

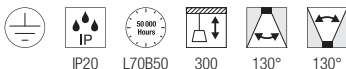

220-240V ~50/60Hz  
Material: alumínio/aço

		IP20	600mA	25W	CCT 3000 / 4000K	400 / 410lm	<b>1004761</b>	<b>535,00 EUR</b>	
	2.0					800 / 820lm	<b>1004762</b>	<b>535,00 EUR</b>	

## ONE® 60 PD, Up/Down, Phase



220-240V ~50/60Hz  
Material: alumínio/aço

		IP20	600mA	24W	CCT 2700 / 3000K	410 / 415lm	<b>1004759</b>	<b>484,00 EUR</b>	
							<b>1004760</b>	<b>484,00 EUR</b>	
							<b>1005177</b>	<b>504,00 EUR</b>	

## ONE® 80 PD, Dali



220-240V ~50/60Hz  
Material: alumínio/aço

		IP20	800mA	32W	CCT 3000 / 4000K	1930 / 2140lm	<b>1002911</b>	<b>474,00 EUR</b>	
	2.0						<b>1002912</b>	<b>474,00 EUR</b>	

## ONE® 80 PD, Up/Down, Dali

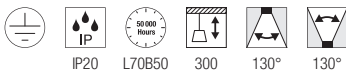

220-240V ~50/60Hz  
Material: alumínio/aço

		IP20	800mA	34W	CCT 3000 / 4000K	615 / 635lm	<b>1004763</b>	<b>636,00 EUR</b>	
	2.0						<b>1004764</b>	<b>636,00 EUR</b>	



### ONE® DOUBLE PD, Up/Down, Dali

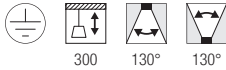

220-240V ~50/60Hz  
Material: alumínio/aço

		-	1400mA	55W	CCT 3000 / 4000K	1050 / 1060lm

<b>1004767</b>	<b>1.110,00 EUR</b>
<b>1004768</b>	<b>1.110,00 EUR</b>



### ONE® DOUBLE PD, Up/Down, Phase

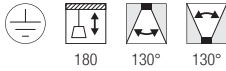

220-240V ~50/60Hz  
Material: alumínio/aço

		-	900mA	35W	CCT 2700 / 3000K	615 / 635lm

<b>1004765</b>	<b>827,00 EUR</b>
<b>1004766</b>	<b>827,00 EUR</b>
<b>1005178</b>	<b>848,00 EUR</b>



### ONE® TRIPLE PD, Dali

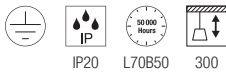

220-240V ~50/60Hz  
Material: alumínio/aço

		IP20	1700mA	64W	CCT 3000 / 4000K	4040 / 4200lm

<b>1002913</b>	<b>1.110,00 EUR</b>
<b>1002914</b>	<b>1.110,00 EUR</b>



### ONE® CUBE PD, Dali



220-240V ~50/60Hz  
Material: alumínio/aço

		IP20	1400mA	54W	3000K	4000lm
		IP20	1400mA	54W	4000K	4300lm

<b>1007661</b>		<b>629,00 EUR</b>
<b>1007662</b>		<b>629,00 EUR</b>
<b>1007663</b>		<b>629,00 EUR</b>
<b>1007664</b>		<b>629,00 EUR</b>



### ONE® CUBE PD, Up/Down, Dali



220-240V ~50/60Hz  
Material: alumínio/aço

		IP20	2100mA	80W	3000K	UP 2000lm DOWN 4000lm
		IP20	2100mA	80W	4000K	UP 2200lm DOWN 4300lm

<b>1007665</b>		<b>699,00 EUR</b>
<b>1007666</b>		<b>699,00 EUR</b>
<b>1007671</b>		<b>699,00 EUR</b>
<b>1007672</b>		<b>699,00 EUR</b>



ONE® LINEAR 140  
1006190





ONE® LINEAR 140

ONE® LINEAR 100

**ONE® LINEAR 100**  
PD, Up/Down, Phase

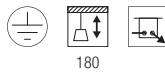

220-240V ~50/60Hz  
Material: alumínio/aço

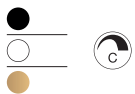

- 600mA 24W CCT 2700 / 3000K

UP 550 / 580lm  
DOWN 670 / 700lm

<b>1006185</b>	<b>312,00 EUR</b>
<b>1006186</b>	<b>312,00 EUR</b>
<b>1006187</b>	<b>333,00 EUR</b>



**ONE® LINEAR 140**  
PD, Up/Down, Phase

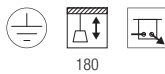

220-240V ~50/60Hz  
Material: alumínio/aço

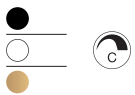

- 900mA 35W CCT 2700 / 3000K

UP 830 / 860lm  
DOWN 980 / 1015lm

<b>1006188</b>	<b>368,00 EUR</b>
<b>1006189</b>	<b>368,00 EUR</b>
<b>1006190</b>	<b>388,00 EUR</b>



Pode encontrar mais detalhes sobre as medidas e informações de montagem nas páginas 200 e 201

ONE® 60  
1002919



ONE® DOUBLE  
1004766

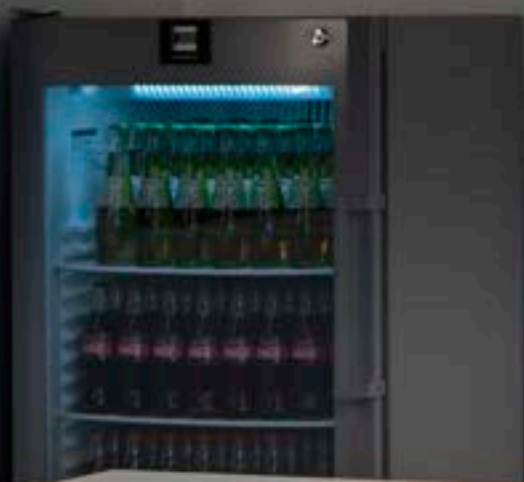





ONE®  
Luminárias salientes de parede e  
teto (CW)

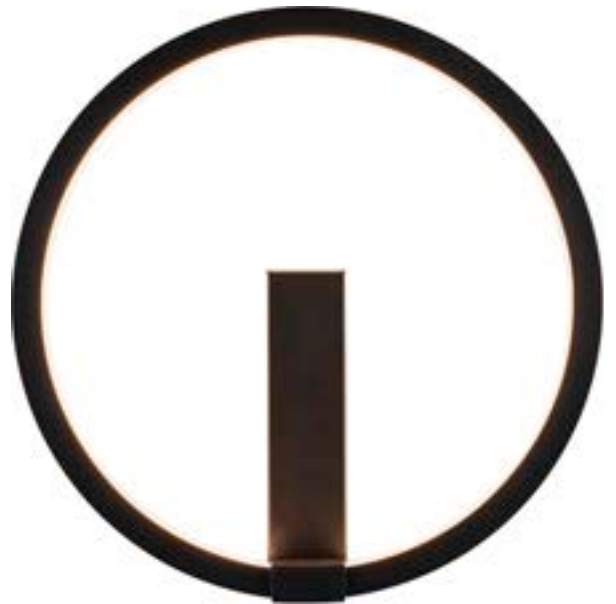

ONE® 40  
CW, Dali



220-240V ~50/60Hz  
Material: alumínio/aço

		IP20	350mA	14W	CCT 3000 / 4000K	700 / 730lm	<b>1002915</b>	<b>343,00 EUR</b>	
							<b>1002917</b>	<b>343,00 EUR</b>	

ONE® 60  
CW, Dali



220-240V ~50/60Hz  
Material: alumínio/aço

		IP20	600mA	24W	CCT 3000 / 4000K	1350 / 1430lm	<b>1002918</b>	<b>413,00 EUR</b>	
							<b>1002919</b>	<b>413,00 EUR</b>	

Pode encontrar mais detalhes sobre as medidas e informações de montagem nas páginas 200 e 201



ONE® 40 TRACK  
1004769

ONE® 40 TRACK  
Calha trifasica, Dali

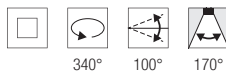

220-240V ~50/60Hz  
Material: alumínio

●	-	350mA	15,2W	3000K	650lm	1004769	333,00 EUR
○						1004770	333,00 EUR
●	-	350mA	15,2W	4000K	670lm	1004771	333,00 EUR
○						1004772	333,00 EUR



Pode encontrar mais detalhes sobre as medidas e informações de montagem nas páginas 200 e 201



ONE® 40 TRACK  
1004771

ONE® 40 TRACK  
Sistema Calha trifásica



Rotativo a 340°  
e orientável  
a 100°



ONE®  
Luminárias de pé (FL)



ONE® STRAIGHT  
FL, Up/Down

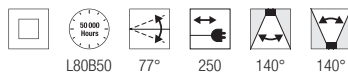

220-240V ~50/60Hz  
Material: aço/policarbonato (PC)



-

24V

22W

CCT 2700 / 3000K

UP 600 / 600lm  
DOWN 600 / 600lm

UGR<22

- 1006355 ● 849,00 EUR
- 1006354 ● 849,00 EUR
- 1006353 ● 849,00 EUR



O fluxo luminoso da fonte de luz pode ser ajustada individualmente

NEW

ONE® BOW  
FL, Up/Down

L80B50    60°    120°    250    140°    140°

220-240V ~50/60Hz  
Material: aço/polycarbonato (PC)

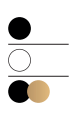

-

24V

22W

CCT 2700 / 3000K

UP 600 / 600lm  
DOWN 600 / 600lm

UGR<22

- 1006352 ● 1.249,00 EUR
- 1006351 ● 1.249,00 EUR
- 1006350 ● 1.249,00 EUR

Pode encontrar mais detalhes sobre as medidas e informações de montagem nas páginas 200 e 201



ONE® STRAIGHT  
1006353



ONE® BOW  
1006351

# ONE®

## LUMINÁRIAS SUSPENSAS

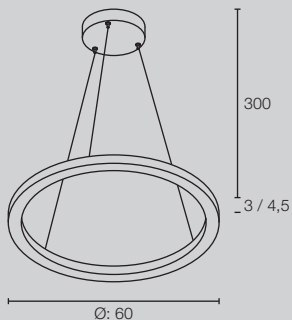

**ONE® 60 / ONE® 60**  
PD, DALI / PD, UP/DOWN, DALI

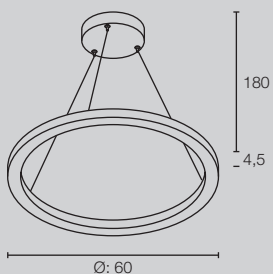

**ONE® 60**  
PD, UP/DOWN, PHASE

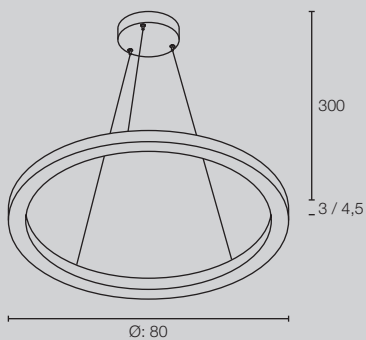

**ONE® 80 / ONE® 80**  
PD, DALI / PD, UP/DOWN, DALI

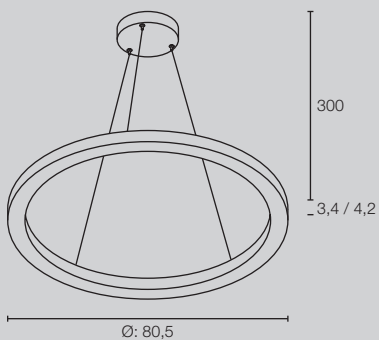

**ONE® CUBE / ONE® CUBE**  
PD, DALI / PD, UP/DOWN, DALI

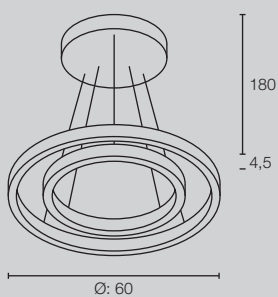

**ONE® DOUBLE 60**  
PD, UP/DOWN, DALI

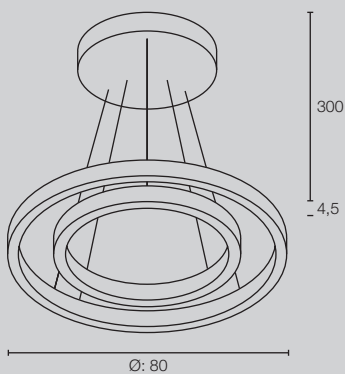

**ONE® DOUBLE 80**  
PD, UP/DOWN, DALI

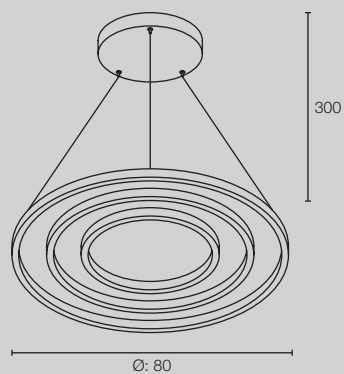

**ONE® TRIPLE**  
PD, DALI



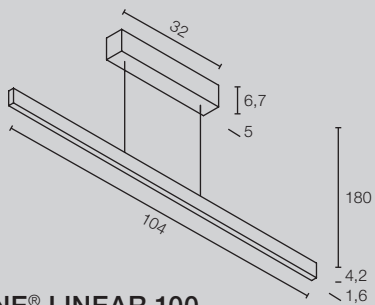

**ONE® LINEAR 100**  
PD, UP/DOWN, DALI

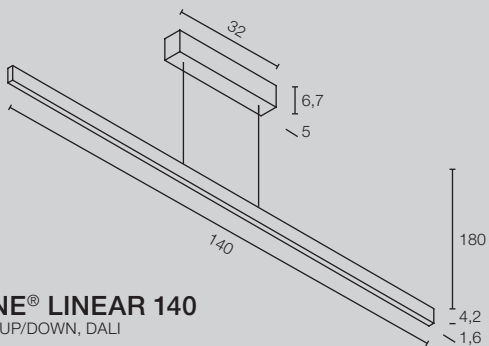

**ONE® LINEAR 140**  
PD, UP/DOWN, DALI

## LUMINÁRIAS DE PAREDE

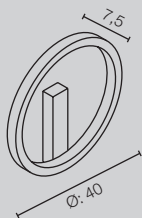

**ONE® 40**  
CW, DALI

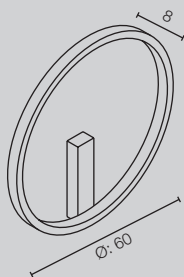

**ONE® 60**  
CW, DALI

## CALHA ELETRIFICADA

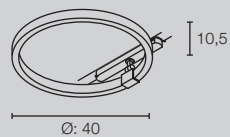

**ONE® 40 TRACK**  
TRACK 3PH, DALI

## LUMINÁRIAS DE PÉ

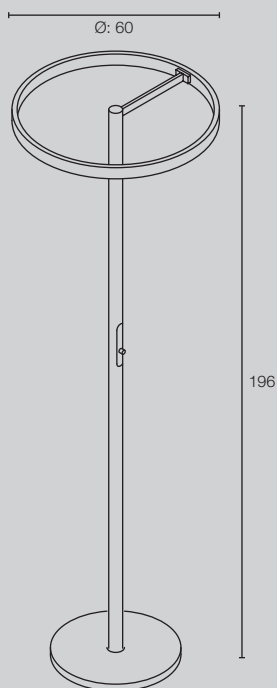

**ONE® STRAIGHT**  
FL, UP/DOWN, SWITCH

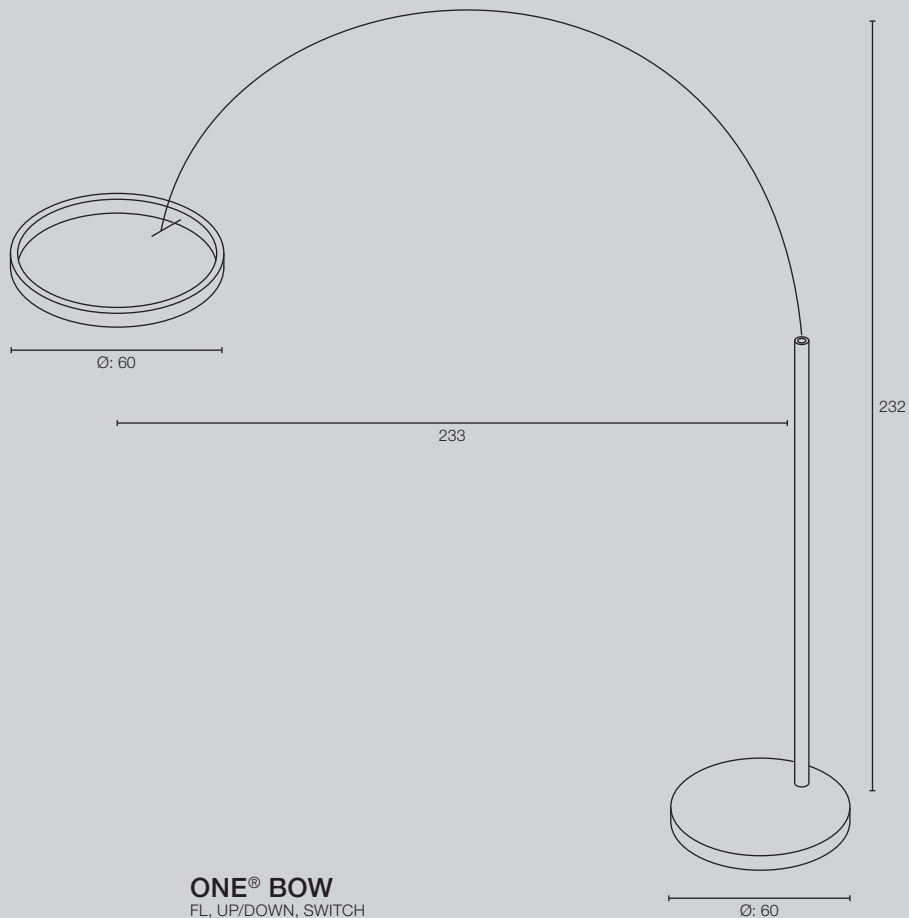

**ONE® BOW**  
FL, UP/DOWN, SWITCH



Encontre a família **NUMINOS®** nas páginas 82–93

LED

NEW



Encontre a família **NEW TRIA®** nas páginas 122–147

LED



Encontre a família **MEDO®** nas páginas 168–171

LED

NEW



LED

UNIVERSAL DOWNLIGHT | 205

NEW



LED

UNIVERSAL DOWNLIGHT | 207

NEW



LED

UNIVERSAL DOWNLIGHT | 208

NEW



LED

UNIVERSAL DOWNLIGHT | 209

NEW



LED

KADUX | 213

NEW



LED

KADUX | 213

NEW



LED

KADUX | 213



SCKET

KADUX | 214



SCKET

KADUX | 214



SCKET

KADUX | 214



SCKET

KADUX | 215



SCKET

KADUX | 215



LED

MILANDOS 4 | 217



LED

MILANDOS 6 | 217



LED

MILANDOS 8 | 217



LED

HORN MINI | 218



SCKET

HORN | 219



SCKET

HORN | 219



SCKET

HORN | 219



SCKET

HORN | 220



SCKET

HORN | 220



SCKET

HORN | 220



SCKET

HORN-T | 221



LED

HORN MAGNA | 221



LED

SENER 12 | 223



LED

SENER 18 | 223



LED

SENER 24 | 223



LED

SENER 12 | 225



LED

SENER 18 | 225



LED

SENER 24 | 225



LED

VERLUX | 227



LED

VERLUX | 227



LED

DL 126 | 227



SCKET

PIKA | 228



SCKET

PIKA | 228



LED

OCULUS | 229



**LED**  
OCCULDAS 14 | 230



**LED**  
OCCULDAS 23 | 230



**LED**  
CONTONE® | 231



**LED**  
CONTONE® | 231



**LED**  
H-LIGHT | 232



**LED**  
KARPO 30 | 232



**SCKET**  
PLASTRA | 233



**SCKET**  
PLASTRA | 233



**LED**  
DEKLED | 234



**SCKET**  
VARU | 234



**SCKET**  
DOLIX OUT | 235



**SCKET**  
DOLIX OUT | 235



**LED**  
KAMUELA ECO | 236



**LED**  
KAMUELA ECO | 237



**LED**  
KINI | 237



**LED**  
AKALO D83 | 237



**LED**  
FRAME BASIC SET | 238



**LED**  
FRAME BASIC | 238



**LED**  
FRAME BASIC | 238



**LED**  
FRAME CURVE | 239



**LED**  
FRAME CURVE | 239



**LED**  
QUAD FRAME 9 | 240



**LED**  
NOTAPO S | 241



**LED**  
NOTAPO L | 241



**LED**  
DOWNUNDER PUR 80 | 242



**LED**  
DOWNUNDER PUR 150 | 242



**LED**  
MOBALA | 243



**LED**  
WORO | 243



**LED**  
LED PANEL | 243



**LED**  
PATTA-I | 244



**LED**  
PATTA-I | 244



**LED**  
PATTA-I | 245



**LED**  
PATTA-I | 245



**LED**  
PATTA-F | 246



**LED**  
PATTA-F | 247

1007095 + 1007180 205

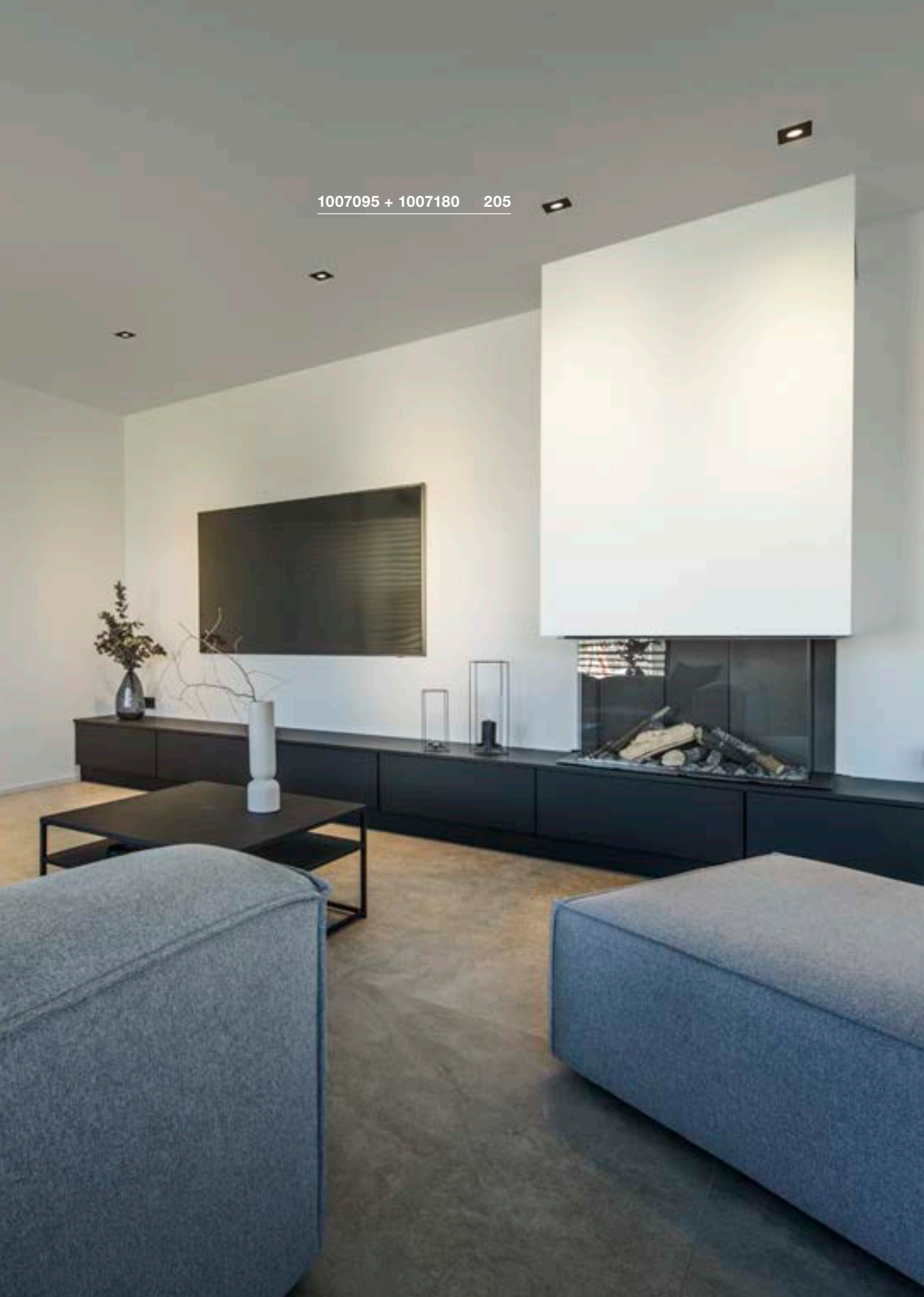



## UNIVERSAL DOWNLIGHT Cover, Redondo



Ø: 8,8 cm  
A: 0,35 cm  
Material: policarbonato (PC)

Variante	Art. n.º	EUR
● Preto	1007096	3,00
○ Branco	1007097	3,00
● Dourado	1007099	3,50
● DouradomAte	1007192	3,50
● Alumínio	1007098	3,50

## UNIVERSAL DOWNLIGHT DL, PHASE

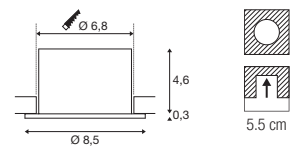

## UNIVERSAL DOWNLIGHT Cover, Quadrado



C: 8,8 cm  
L: 8,8 cm  
A: 0,35 cm  
Material: policarbonato (PC)

Variante	Art. n.º	EUR
● Preto	1007180	4,00
○ Branco	1007181	4,00
● Dourado	1007183	4,50
● DouradomAte	1007193	4,50
● Alumínio	1007182	4,50



220-240V ~50/60Hz | 60/90mA  
Potência total: 5W/8W  
Material: aço

- Espessura do teto falso: máx. 25 mm



5W	410lm	2700K
	430lm	3000K
	470lm	4000K
	440lm	6500K
8W	560lm	2700K
	610lm	3000K
	680lm	4000K
	640lm	6500K

Variante	Art. n.º	EUR
● Preto	1007095	26,50

1007090 + 1007184 205



WATCH OUT  
MONSTER INSIDE



1002



### UNIVERSAL DOWNLIGHT Cover, Redondo



Ø: 8,8 cm  
A: 0,35 cm  
Material: policarbonato (PC)

Variante	Art. n.º	EUR
● Preto	1007091	3,00
○ Branco	1007092	3,00
● Dourado	1007094	3,50
● DouradoAte	1007191	3,50
● Alumínio	1007093	3,50

### UNIVERSAL DOWNLIGHT DL, Move, PHASE

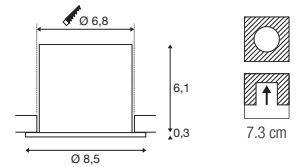

### UNIVERSAL DOWNLIGHT Cover, quadrado



C: 8,8 cm  
L: 8,8 cm  
A: 0,35 cm  
Material: policarbonato (PC)

Variante	Art. n.º	EUR
● Preto	1007184	4,00
○ Branco	1007185	4,00
● Dourado	1007187	4,50
● DouradoAte	1007194	4,50
● Alumínio	1007186	4,50

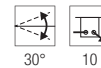

220-240V ~50/60Hz | 60/90mA  
Potência total: 5W/8W  
Material: aço

- Espessura do Material da área de instalação: máx. 25 mm



5W	410lm	2700K
	610lm	3000K
	680lm	4000K
	640lm	6500K
8W	560lm	2700K
	610lm	3000K
	680lm	4000K
	640lm	6500K

Variante	Art. n.º	EUR
● Preto	1007090	27,00

# UNIVERSAL DOWNLIGHT DL with Cover, Multipack

1007271 208

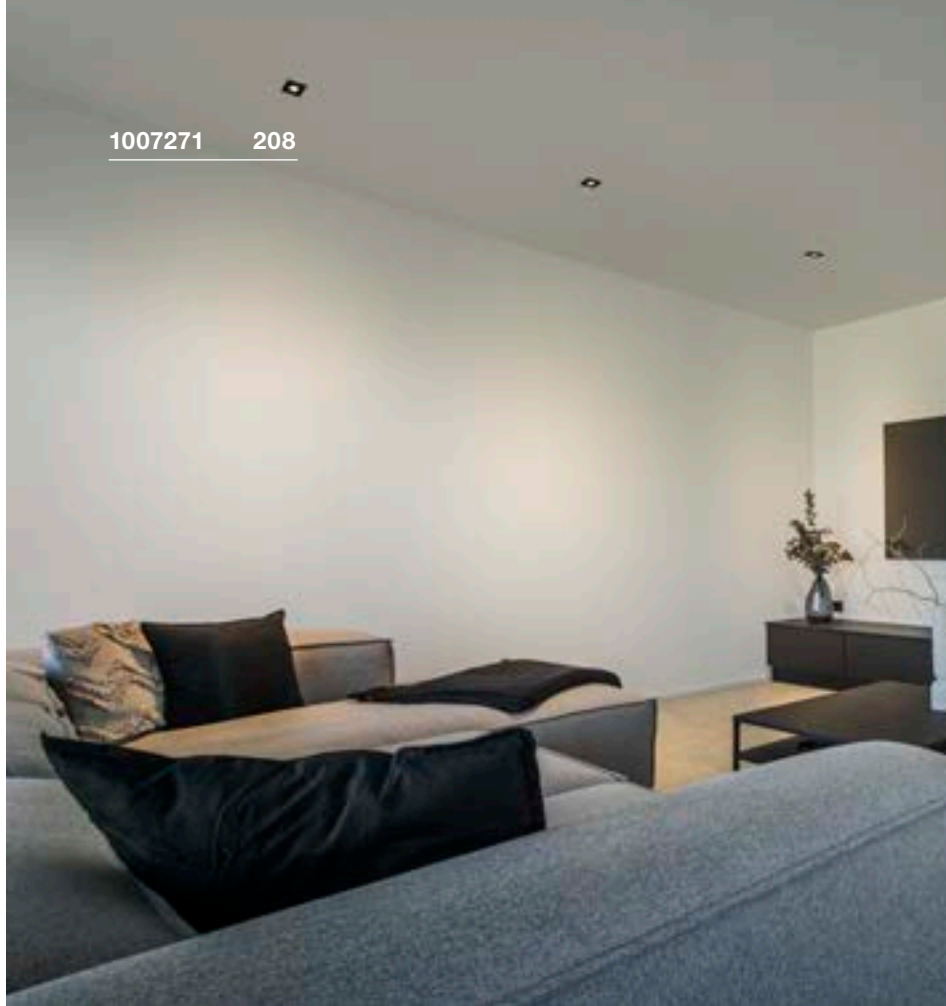
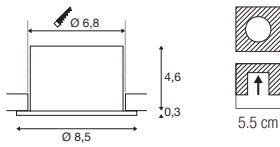

220-240V ~50/60Hz | 60/90mA  
Potência total: 5W/8W  
Material: aço

- Espessura do teto falso: máx. 25 mm



5W	560lm	2700K
	610lm	3000K
	680lm	4000K
	640lm	6500K
8W	560lm	2700K
	610lm	3000K
	680lm	4000K
	640lm	6500K

Variante	Art. n.º	EUR
● Preto	1007271	354,00
○ Branco	1007272	354,00







## UNIVERSAL DOWNLIGHT DL with Cover, Multipack



NEW

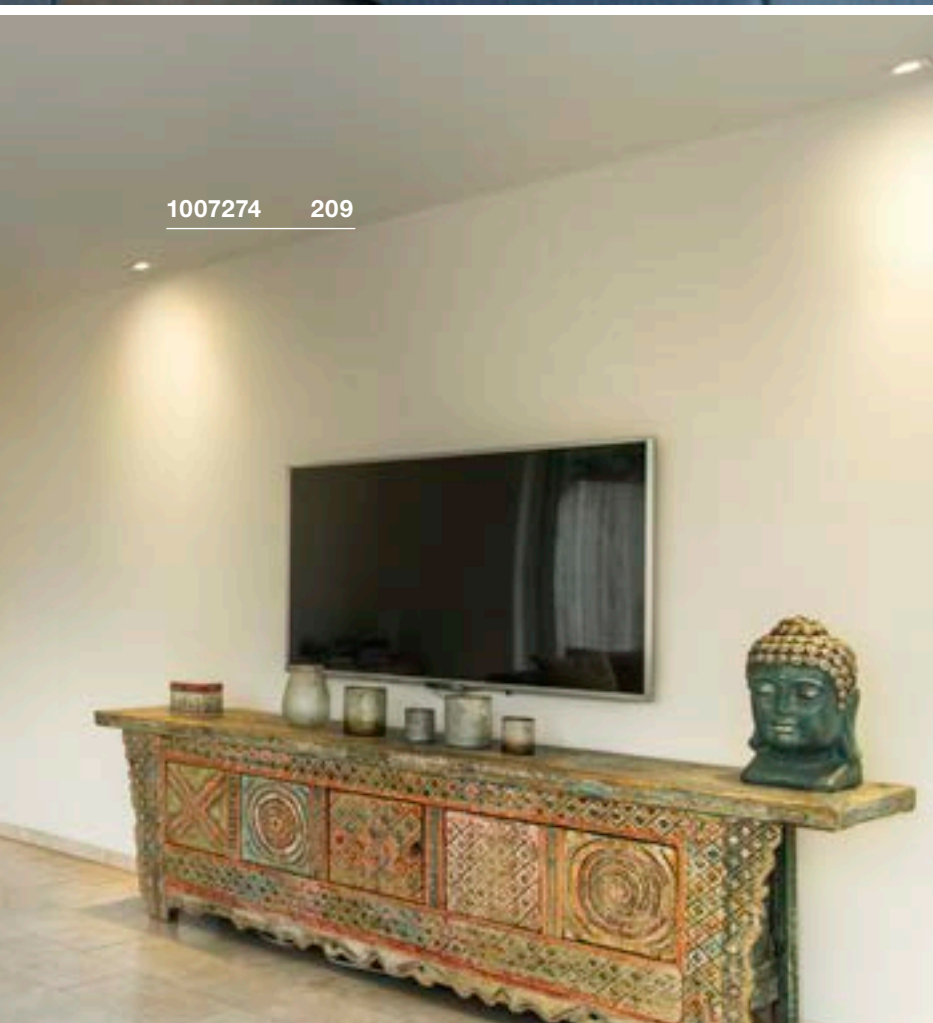
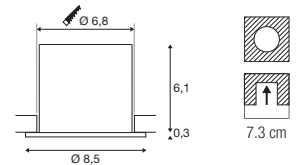

1007274 209

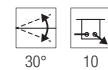

220-240V ~50/60Hz | 60/90mA  
Potência total: 5W/8W  
Material: aço

- Espessura do teto falso: máx. 25 mm



5W	410lm	2700K
	610lm	3000K
	680lm	4000K
	640lm	6500K
8W	560lm	2700K
	610lm	3000K
	680lm	4000K
	640lm	6500K

Variante	Art. n.º	EUR
● Preto	1007273	360,00
○ Branco	1007274	360,00

# CONFIGURE O SEU DOWNLIGHT

---

Discretas e universalmente aplicáveis: as UNIVERSAL DOWNLIGHT com variante fixa e articulada são luminárias de encastrar que produzem uma luz direcionada com o seu ângulo de semiabertura de 36 graus. Antes da instalação, a temperatura de cor da luz pode ser selecionada a partir de uma ampla gama (2700/3000/4000/6500K) através do interruptor CCT. Uma reprodução cromática realista é alcançada com um IRC superior a 90. Graças à caixa de ligação rápida (Quick Connector Box), o Downlight também pode ser instalado de forma rápida e fácil. Complete o seu downlight universal com aro redondo ou quadrado, disponível separadamente, com acabamentos nas cores preto, branco, cromado, dourado brilhante e douradoMate.

## SELECIONE O SEU FAVORITO ...

- 1 Variante (fixa, articulada)
- 2 Aro (preto, branco, cromado, dourado brilhante, douradoMate)
- 3 Temperatura de cor (2700, 3000, 4000, 6500K)
- 4 Potência total (5W, 8W)



JÁ ESTÁ!

# UNIVERSAL DOWNLIGHT

## UNIVERSAL DOWNLIGHT



Disponível na versão fixa, quadrada ou redonda

## UNIVERSAL DOWNLIGHT MOVE



Disponível na versão articulada, quadrada ou redonda

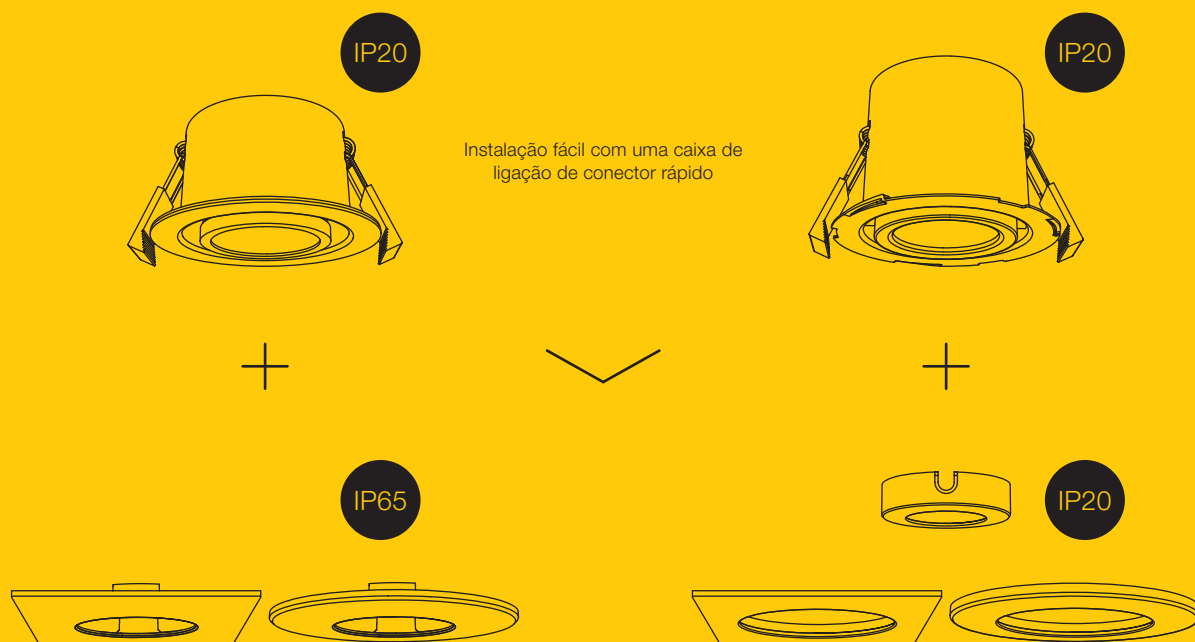

Aro intercambiável em formato quadrado ou redondo e com acabamento nas cores preto, branco, cromado, dourado brilhante ou douradoMate

2700K 3000K 4000K 6500K Temperatura da cor comutável 2700K 3000K 4000K 6500K

Potência total comutável 5W / 8W

Elevada qualidade de luz e reprodução cromática por LED com IRC90

1007560 213



1007567 213



1007551 213

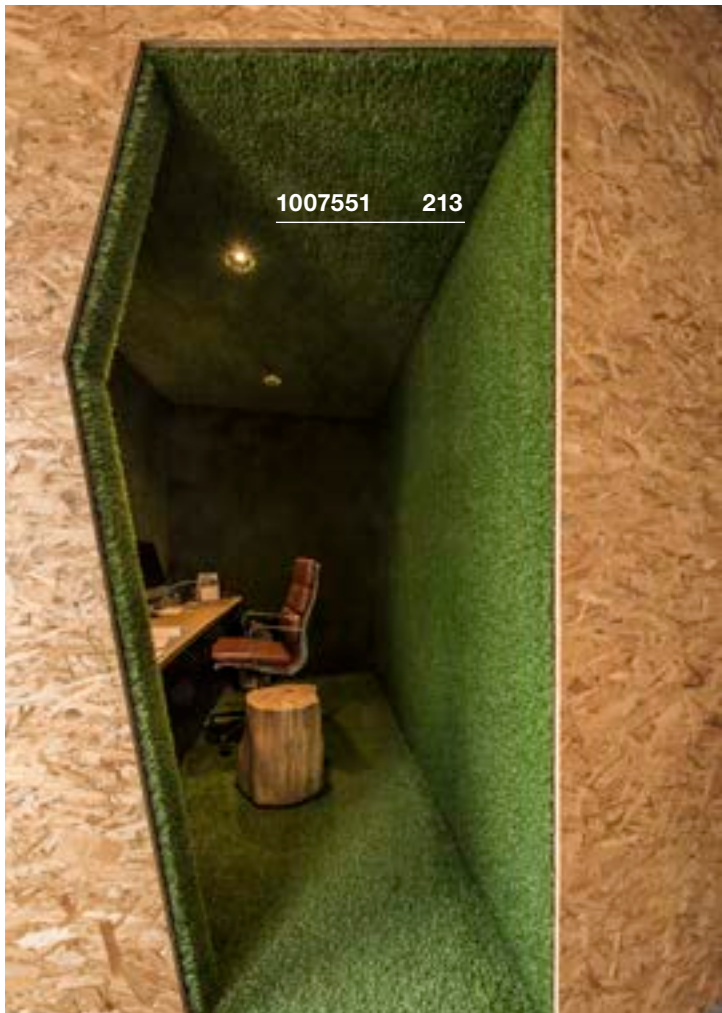



KADUX  
DL, single, PHASE

KADUX  
DL, double, PHASE

KADUX  
DL, triple, PHASE

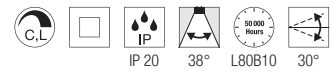
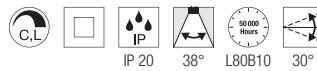
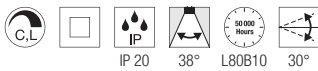
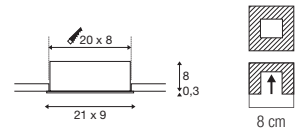
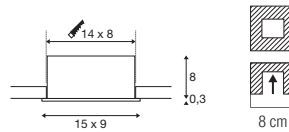
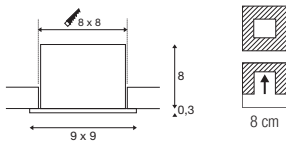

220-240V ~50/60Hz | 350mA  
Potência total: 7,5W  
Material: alumínio/aço

220-240V ~50/60Hz | 350mA  
Potência total: 14W  
Material: alumínio/aço

220-240V ~50/60Hz | 350mA  
Potência total: 20W  
Material: alumínio/aço

- Molas
- Espessura do teto falso: máx. 30 mm

- Molas
- Espessura do teto falso: máx. 30 mm

- Molas
- Espessura do teto falso: máx. 30 mm



Down 770lm | 3000K

Down 1510lm | 3000K

Down 2310lm | 3000K

Variante	Art. n.º	EUR
● Preto	1007551	85,00
○ Branco	1007552	85,00

Variante	Art. n.º	EUR
● Preto	1007559	160,00
○ Branco	1007560	160,00

Variante	Art. n.º	EUR
● Preto	1007567	211,00
○ Branco	1007568	211,00

KADUX  
EL, single, QPAR51

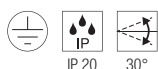
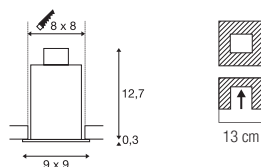

220-240V ~50/60Hz  
Material: alumínio/aço

- Molas
- Espessura do teto falso: máx. 30 mm



Casquilho: 1xGU10

Variante	Art. n.º	EUR
● Preto	115510	33,25
○ Branco	115511	33,25

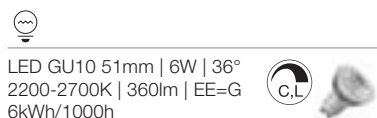

Art. N.º: 1005273 | 9,99 EUR

KADUX  
EL, double, QPAR51

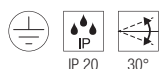
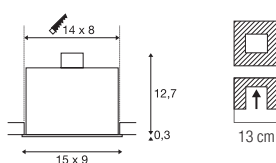

220-240V ~50/60Hz  
Material: alumínio/aço

- Molas
- Espessura do teto falso: máx. 30 mm



Casquilho: 2xGU10

Variante	Art. n.º	EUR
● Preto	115520	61,00
○ Branco	115521	61,00



Art. N.º: 1005273 | 9,99 EUR

KADUX  
EL, triple, QPAR51

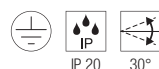
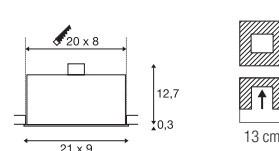

220-240V ~50/60Hz  
Material: alumínio/aço

- Molas
- Espessura do teto falso: máx. 30 mm



Casquilho: 3xGU10

Variante	Art. n.º	EUR
● Preto	115530	83,00
○ Branco	115531	83,00

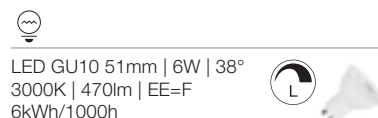

Art. N.º: 1005079 | 7,50 EUR



115550 215

KADUX  
EL, single, QPAR111

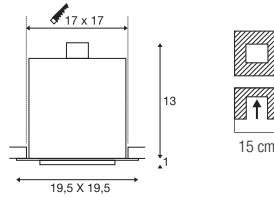

KADUX  
EL, double, QPAR111

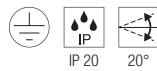
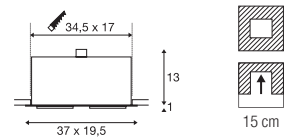

220-240V ~50/60Hz  
Material: alumínio/aço

- Molas
- Espessura do teto falso: máx. 25 mm



Casquilho: 1xGU10

Variante	Art. n.º	EUR
● Preto	115540	107,00
○ Branco	115541	107,00

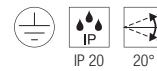

220-240V ~50/60Hz  
Material: alumínio/aço

- Molas
- Espessura do teto falso: máx. 25 mm



Casquilho: 2xGU10

Variante	Art. n.º	EUR
● Preto	115550	164,00
○ Branco	115551	164,00



115531 214



QPAR111 | 8W | 38°  
2700K | 680lm | EE=F  
8kWh/1000h

Art. N.º: 1005274 | 30,75 EUR



QPAR111 | 8W | 38°  
2700K | 680lm | EE=F  
8kWh/1000h

Art. N.º: 1005274 | 30,75 EUR









## MILANDOS 4 DL

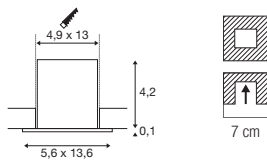

700mA  
Consumo de energia: 8W  
Material: alumínio / policarbonato (PC)

- Molas
- Espessura do teto falso: máx. 40 mm



Down	510lm	2700K
	520lm	3000K
	650lm	3000K

Variante	Art. n.º	EUR
● Preto		
510lm   2700K	<b>1005407</b>	<b>190,00</b>
● Preto		
520lm   3000K	<b>1005408</b>	<b>190,00</b>
○ Branco		
650lm   3000K	<b>1005410</b>	<b>190,00</b>



Artigo	Art. n.º	EUR
Driver 4-20W   250-700mA 1-10 V/DALI   incl. alívio de tensão		
○ Branco	<b>1002423</b>	<b>85,00</b>
Driver 10W   700mA   regulável em fase incl. alívio de tensão		
○ Branco	<b>1007213</b>	<b>35,00</b>

## MILANDOS 6 DL

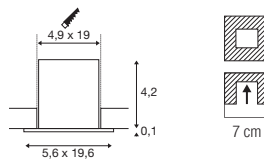

700mA  
Consumo de energia: 12W  
Material: alumínio / policarbonato (PC)

- Molas
- Espessura do teto falso: máx. 40 mm



Down	770lm	2700K
	780lm	3000K
	980lm	3000K

Variante	Art. n.º	EUR
● Preto		
770lm   2700K	<b>1005415</b>	<b>212,00</b>
● Preto		
780lm   3000K	<b>1005416</b>	<b>212,00</b>
○ Branco		
980lm   3000K	<b>1005418</b>	<b>212,00</b>



Artigo	Art. n.º	EUR
Driver 12-18W   700mA regulável em fase inv. inclui alívio de tensão		
○ Branco	<b>1006202</b>	<b>34,00</b>
Driver 4-20W   250-700mA 1-10 V/DALI   incl. alívio de tensão		
○ Branco	<b>1002423</b>	<b>85,00</b>

## MILANDOS 8 DL

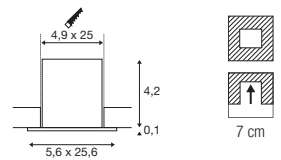

700mA  
Consumo de energia: 16W  
Material: alumínio / policarbonato (PC)

- Molas
- Espessura do teto falso: máx. 40 mm



Down	1030lm	2700K
	1040lm	3000K

Variante	Art. n.º	EUR
● Preto		
1030lm   2700K	<b>1005423</b>	<b>259,00</b>
● Preto		
1040lm   3000K	<b>1005424</b>	<b>259,00</b>



Artigo	Art. n.º	EUR
Driver 4-20W   250-700mA 1-10 V/DALI   incl. alívio de tensão		
○ Branco	<b>1002423</b>	<b>85,00</b>
Driver 12-18W   700mA regulável em fase inv. inclui alívio de tensão		
○ Branco	<b>1006202</b>	<b>34,00</b>

# HORN MINI EL

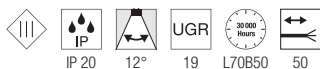
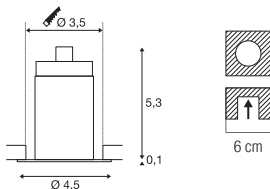

350mA  
Consumo de energia: 1W  
Material: alumínio / policarbonato (PC)

- Molas
- Com ficha elétrica AMP
- Com refletor dourado, a cor da luz é diferente
- Não inclui controlador / driver



Down 70lm | 2900K  
3000K

Variante	Art. n.º	EUR
● Preto 3000 K	1000915	40,25
● Preto/dourado 2900 K	1000917	43,75
○ Branco 3000 K	1000914	40,25



Artigo	Art. n.º	EUR
Extensão de cabo: 1 m		
○ Branco	111861	7,75
LED driver 3W   350mA incl. ficha AMP		
○ Branco	1007270	19,80
Extensão de 3 tomadas com fichas AMP		
● Preto	111850	13,40

113141 219



1000914 218





**HORN**  
DL, single, QPAR51

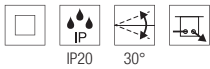
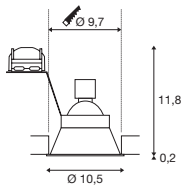

220-240V ~50/60Hz  
Material: alumínio

- Molas
- Espessura do teto falso: máx. 30 mm



Base: 1xGU10

Variante	Art. n.º	EUR
● Preto	113140	52,00
○ Branco	113141	52,00



LED GU10 51mm | 6W | 38°  
2700K | 450lm | EE=F  
6kWh/1000h



Art. N.º: 1005077 | 7,50 EUR

**HORN**  
DL, double, QPAR51

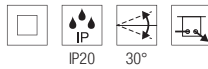
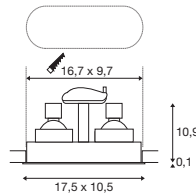

220-240V ~50/60Hz  
Material: alumínio

- Molas
- Espessura do teto falso: máx. 30 mm



Base: 2xGU10

Variante	Art. n.º	EUR
● Preto	1006121	75,00
○ Branco	1006122	75,00



LED GU10 51mm | 6W | 38°  
2700K | 450lm | EE=F  
6kWh/1000h



Art. N.º: 1005077 | 7,50 EUR

**HORN**  
DL, single, assimétrico, QPAR51

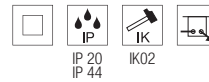
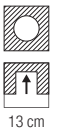
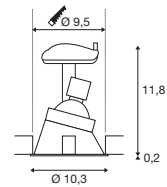

220-240V ~50/60Hz  
Material: alumínio

- Molas
- Espessura do teto falso: máx. 30 mm



Base: 1xGU10

Variante	Art. n.º	EUR
● Preto	113150	57,00
○ Branco	113151	57,00



LED GU10 51mm | 6W | 36°  
2200-2700K | 360lm | EE=G  
6kWh/1000h



Art. N.º: 1005273 | 9,99 EUR

**HORN**  
DL, single, QPAR51

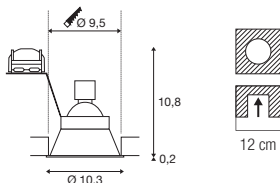

220-240V ~50/60Hz  
Material: alumínio

- Molas
- Espessura do teto falso: máx. 25 mm



Casquilho: 1xGU10

Variante	Art. n.º	EUR
● Preto	113160	52,00
○ Branco	113161	52,00



LED GU10 51mm | 6W | 38°  
2700K | 450lm | EE=F  
6kWh/1000h



Art. N.º: 1005077 | 7,50 EUR

**HORN**  
EL, single, QPAR51

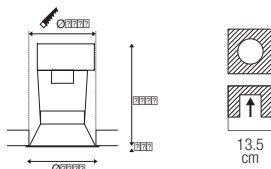

220-240V ~50/60Hz  
Material: aço

- Molas
- Espessura do teto falso: máx. 45 mm



Casquilho: 1xGU10 Máx. Ø: 5,1 cm | C: 5,4 cm

Variante	Art. n.º	EUR
● Preto	112910	27,50
○ Branco	112911	27,50



LED GU10 51mm | 6W | 38°  
2700K | 450lm | EE=F  
6kWh/1000h



Art. N.º: 1005077 | 7,50 EUR

**HORN**  
DL, GU10, Blower door tested

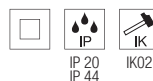
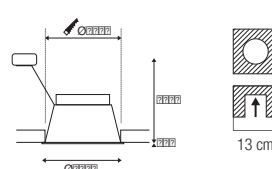

220-240V ~50/60Hz  
Material: alumínio

- O downlight cumpre os requisitos da norma RT2012.
- Espessura do teto falso: máx. 30 mm



Casquilho: 1xGU10

Variante	Art. n.º	EUR
● Preto	1005435	26,50
○ Branco	1005436	26,50



LED GU10 51mm | 6W | 38°  
2700K | 450lm | EE=F  
6kWh/1000h



Art. N.º: 1005077 | 7,50 EUR



112911 220

## HORN-T EL, QPAR111

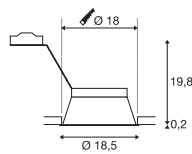

## HORN MAGNA EL

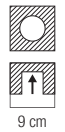
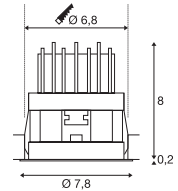

1002592 221

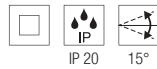

220-240V ~50/60Hz  
Material: aço

- Molas
- Espessura do teto falso: máx. 30 mm



Casquilho: 1xGU10

Variante	Art. n.º	EUR
● Preto	113170	69,00
○ Branco	113171	69,00



QPAR111 | 8W | 38°  
2700K | 680lm | EE=F  
8kWh/1000h

Art. N.º: 1005274 | 30,75 EUR

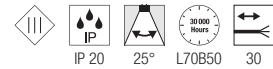

500mA  
Consumo de energia: 9W  
Material: alumínio / policarbonato (PC)

- Com refletor dourado, a cor da luz é diferente
- Molas
- Espessura do teto falso: máx. 25 mm
- Extremidade do cabo aberta



Down  
445lm | 3000K  
550lm | 570lm

Variante	Art. n.º	EUR
● Preto		
445lm	1002592	75,00
● Preto/dourado		
570lm	1002594	78,00
○ Branco		
550lm	1002591	75,00



Artigo	Art. n.º	EUR
LED driver 20W 350mA/500mA PHASE		
○ Branco	1007227	40,00
Controlador LED 25W   150-700mA   DALI regulável		
○ Branco	1007229	70,00
Controlador LED 21W   500mA incl. alívio de tensão		
○ Branco	1007226	30,00

1003010 223





## SENER 12 EL, Redondo

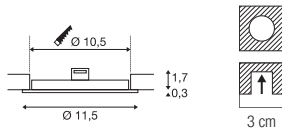

200mA  
Consumo de energia: 6,4W  
Material: alumínio

- Molas
- Espessura do teto falso: máx. 15 mm



Down 420lm | 3000K  
470lm | 4000K

Variante	Art. n.º	EUR
○ Branco 420lm   3000K   6.4W	<b>1003008</b>	<b>29,50</b>
○ Branco 470lm   4000K   6W	<b>1004694</b>	<b>29,50</b>



Artigo	Art. n.º	EUR
Driver 25W   150-700mA   DALI		
○ Branco	<b>1007229</b>	<b>70,00</b>
Driver 10W   200mA   regulável em fase, incl. alívio de tensão		
○ Branco	<b>1007215</b>	<b>35,00</b>

## SENER 18 EL, Redondo

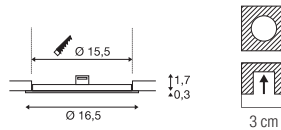

350mA  
Consumo de energia: 10W  
Material: alumínio

- Molas
- Espessura do teto falso: máx. 15 mm



Down 880lm | 3000K  
990lm | 4000K

Variante	Art. n.º	EUR
○ Branco 880lm   3000K   10W	<b>1003009</b>	<b>34,00</b>
○ Branco 990lm   4000K   12W	<b>1004695</b>	<b>34,00</b>



Artigo	Art. n.º	EUR
Driver 20W   350mA   regulável em fase		
○ Branco	<b>1007228</b>	<b>40,00</b>
Driver 25W   150-700mA   DALI regulável		
○ Branco	<b>1007229</b>	<b>70,00</b>

## SENER 24 EL, Redondo

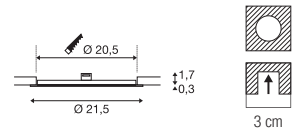

500mA  
Consumo de energia: 13W  
Material: alumínio

- Molas
- Espessura do teto falso: máx. 15 mm



Down 1200lm | 3000K  
1300lm | 4000K

Variante	Art. n.º	EUR
○ Branco 1200lm   3000K	<b>1003010</b>	<b>45,25</b>
○ Branco 1300lm   4000K	<b>1004696</b>	<b>45,25</b>



Artigo	Art. n.º	EUR
Driver 20W   350mA/500mA   regulável em fase		
○ Branco	<b>1007227</b>	<b>40,00</b>
Driver 25W   150-700mA   DALI		
○ Branco	<b>1007229</b>	<b>70,00</b>
Driver 21W   500mA incl. alívio de tensão		
○ Branco	<b>1007226</b>	<b>30,00</b>

1003011 225







## SENER 12 EL, quadrado

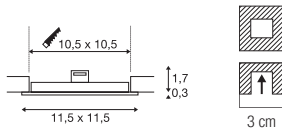

200mA  
Consumo de energia: 6,4W  
Material: alumínio

- Molas
- Espessura domaterial da área de instalação: máx. 15 mm



Down 440lm | 3000K | 4000K

Variante	Art. n.º	EUR
○ Branco 3000K	<b>1003011</b>	<b>29,50</b>
○ Branco 4000K	<b>1004697</b>	<b>29,50</b>



Artigo	Art. n.º	EUR
Driver 25W   150-700mA   DALI		
○ Branco	<b>1007229</b>	<b>70,00</b>
Driver 10W   200mA   regulável em fase, incl. alívio de tensão		
○ Branco	<b>1007215</b>	<b>35,00</b>

## SENER 18 EL, quadrado

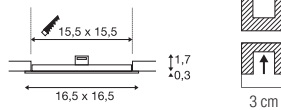

350mA  
Consumo de energia: 10W  
Material: alumínio

- Molas
- Espessura domaterial da área de instalação: máx. 15 mm



Down 880lm | 900lm | 4000K | 3000K

Variante	Art. n.º	EUR
○ Branco 900lm   3000K   10W	<b>1003012</b>	<b>34,00</b>
○ Branco 880lm   4000K   12W	<b>1004698</b>	<b>34,00</b>



Artigo	Art. n.º	EUR
Driver 20W   350mA   regulável em fase		
○ Branco	<b>1007228</b>	<b>40,00</b>
Driver 25W   150-700mA   DALI		
○ Branco	<b>1007229</b>	<b>70,00</b>

## SENER 24 EL, quadrado

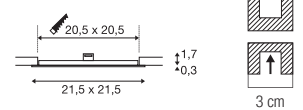
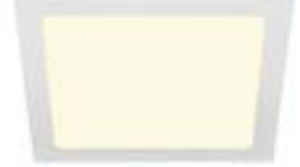

500mA  
Consumo de energia: 13W  
Material: alumínio

- Molas
- Espessura domaterial da área de instalação: máx. 15 mm



Down 1100lm | 1240lm | 3000K | 4000K

Variante	Art. n.º	EUR
○ Branco 1100lm   3000K	<b>1003013</b>	<b>45,25</b>
○ Branco 1240lm   4000K	<b>1004699</b>	<b>45,25</b>



Artigo	Art. n.º	EUR
Driver 20W   350mA/500mA   regulável em fase		
○ Branco	<b>1007227</b>	<b>40,00</b>
Driver 25W   150-700mA   DALI		
○ Branco	<b>1007229</b>	<b>70,00</b>
Driver 21W   500mA incl. alívio de tensão		
○ Branco	<b>1007226</b>	<b>30,00</b>

112682 227



112222 227



112225 227

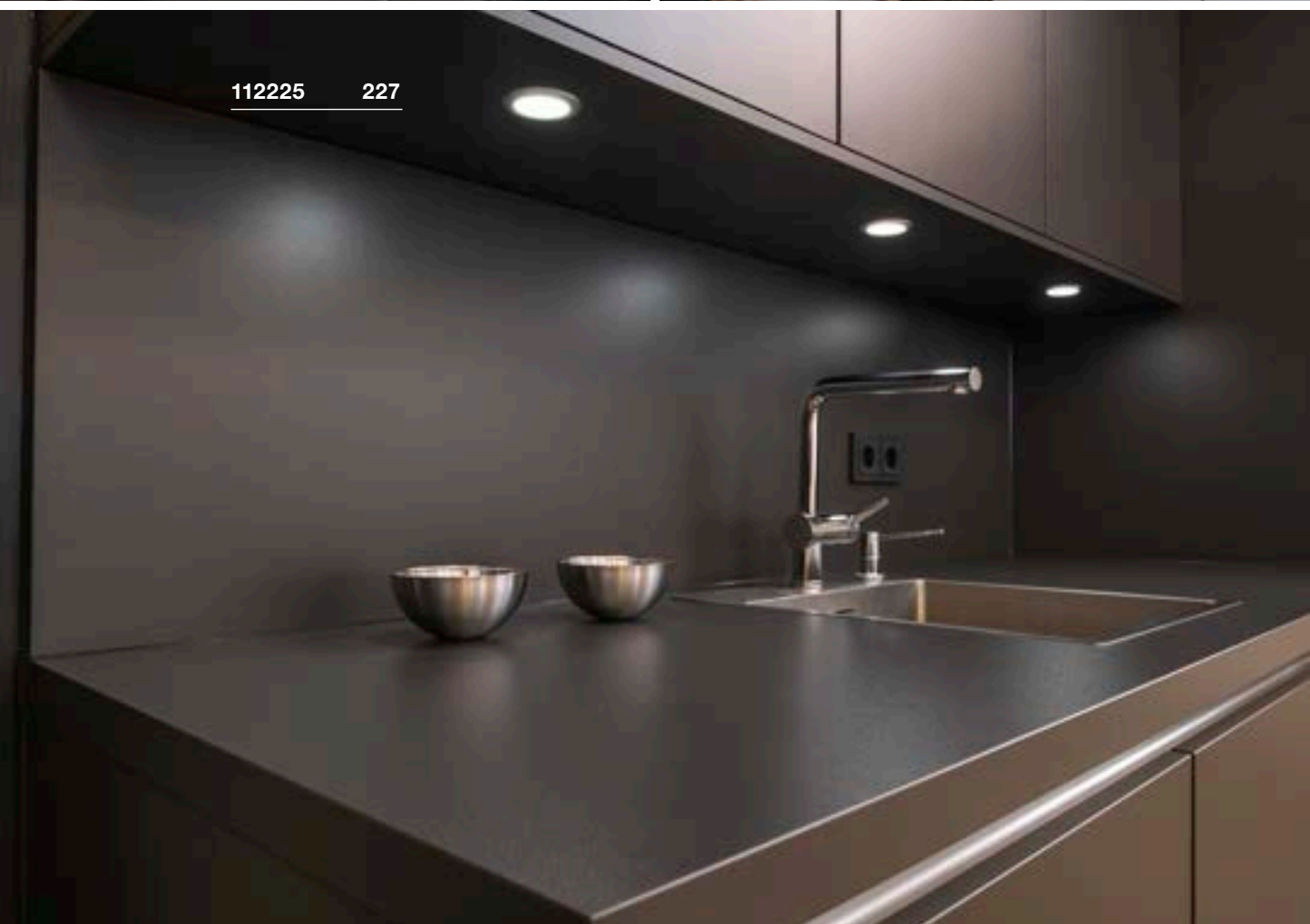



VERLUX  
EL, quadrado, PHASE

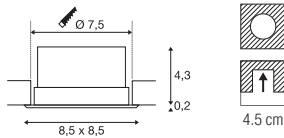

220-240V ~50/60Hz | 500mA  
Potência total: 11W  
Material: alumínio/plástico

- Molas
- Espessura do teto falso: máx. 20 mm



Down 940lm | 3000K

Variante	Art. n.º	EUR
○ Branco	112682	90,00

VERLUX  
EL, quadrado, PHASE

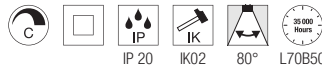
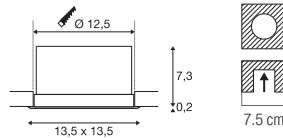

220-240V ~50/60Hz | 500mA  
Potência total: 22W  
Material: alumínio/plástico

- Molas
- Espessura do teto falso: máx. 25 mm



Down 1800lm | 3000K

Variante	Art. n.º	EUR
○ Branco	112692	133,00

DL 126  
EL

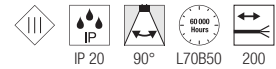
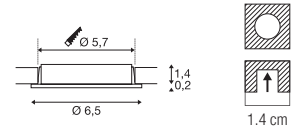

12V DC  
Consumo de energia: 2,8W  
Material: alumínio/plástico

- Molas



Down 170lm | 3000K

Variante	Art. n.º	EUR
○ Branco	112221	36,25
● Cromado	112222	42,25
● Cinzento	112225	36,25



Artigo	Art. n.º	EUR
Transformador 18W   12/24V DC incl. alívio de tensão		
○ Branco	1005381	39,50
Transformador 15W   12V DC		
○ Branco	1005444	29,50

PIKA  
DL, Redondo, QPAR51, fixo

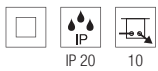
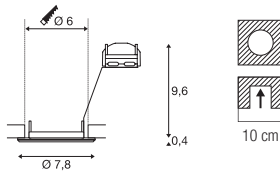

220-240V ~50/60Hz  
Material: alumínio

- Molas
- Espessura do teto falso: máx. 13 mm



Casquilho: 1xGU10

Variante	Art. n.º	EUR
○ Branco	1000714	12,70
● Bronze	1000716	18,20
● Cromado	1000715	18,20
● Cinzento	1000717	12,70

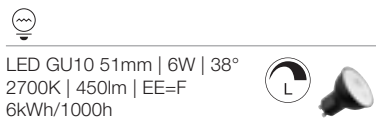

Art. N.º: 1005077 | 7,50 EUR

PIKA  
DL, Redondo, QPAR51, orientável

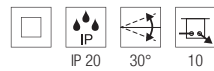
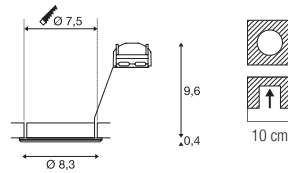

220-240V ~50/60Hz  
Material: alumínio

- Molas
- Espessura do teto falso: máx. 15 mm



Casquilho: 1xGU10

Variante	Art. n.º	EUR
○ Branco	1000718	18,20
● Bronze	1000720	20,50
● Cromado	1000719	20,50
● Cinzento	1000721	18,20

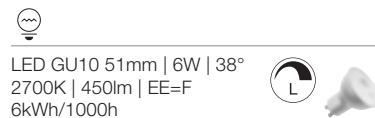

Art. N.º: 1005075 | 7,50 EUR

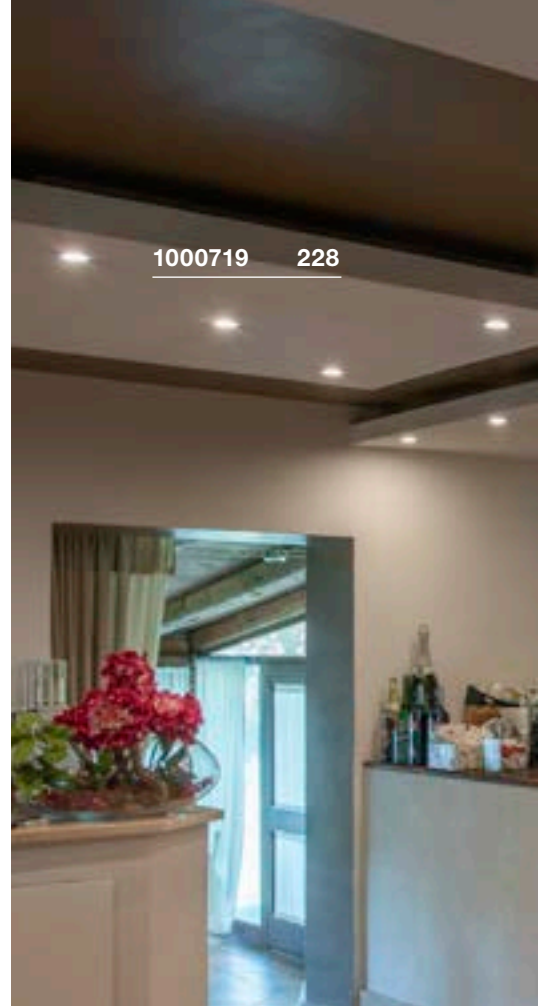

1000719 228

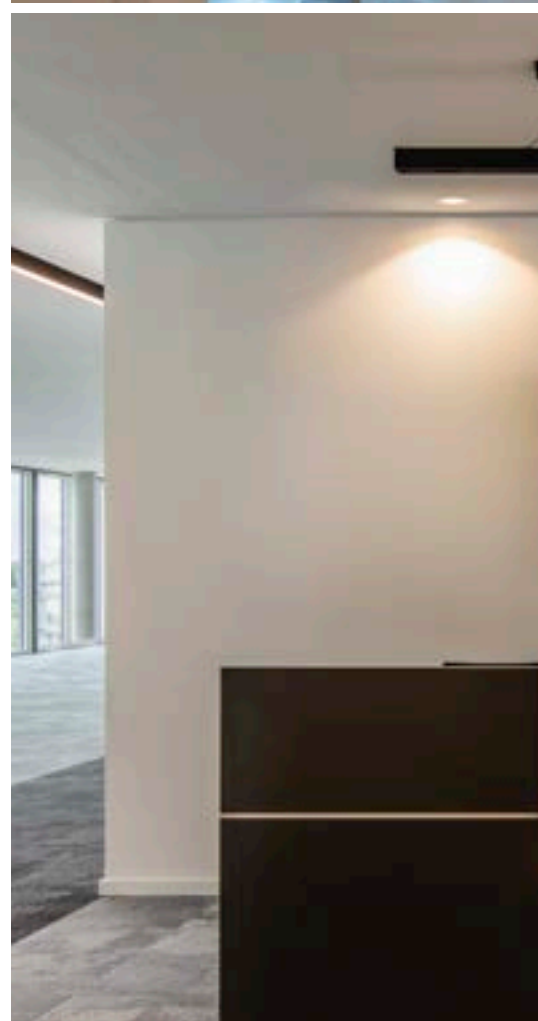



## OCULUS CL, Move, PHASE

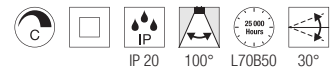
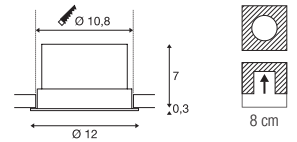

220-240V ~50/60Hz | 250mA

Potência total: 11W

Material: alumínio/vidro

- Molas
- Lente fosca adicional incluída
- Espessura do teto falso: máx. 20 mm



Down 36lm | 2000K - 780lm | 3000K

Variante	Art. n.º	EUR
● Preto	1004668	209,00
○ Branco	1004669	209,00

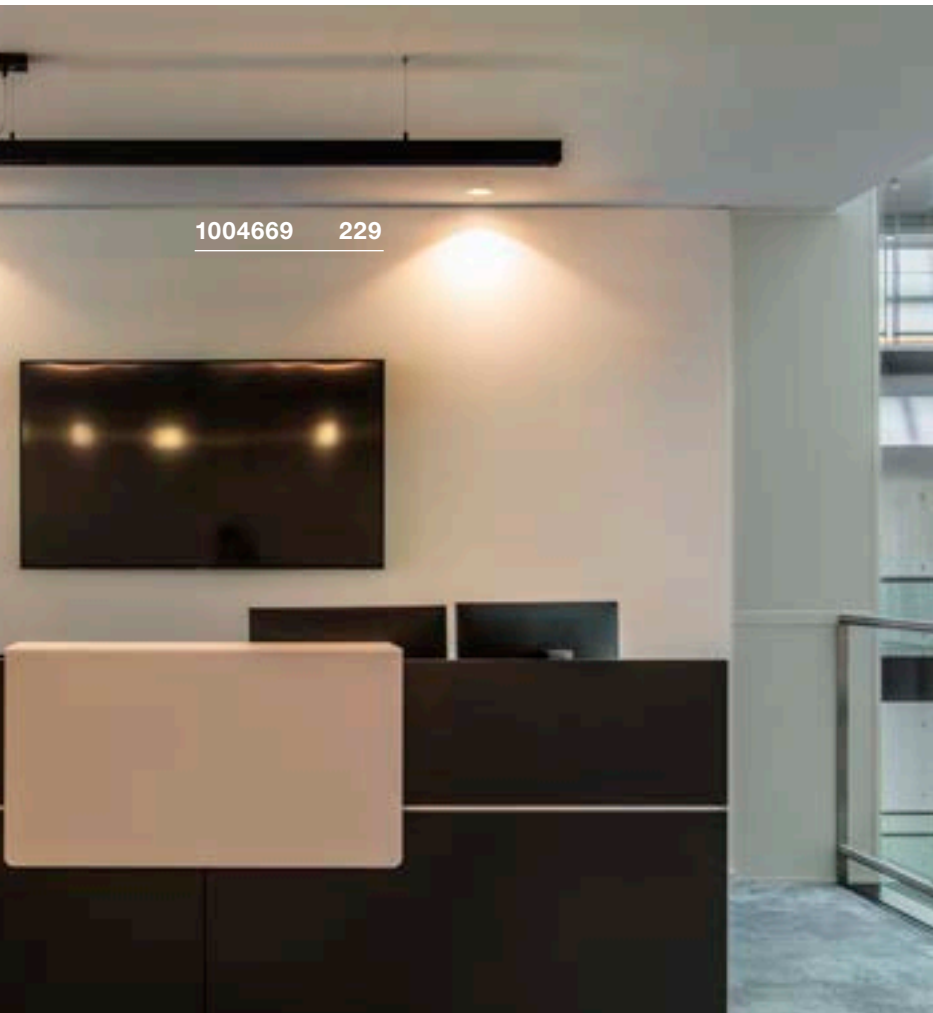

1004669 229

OCCULDAS 14  
EL, Indireta, PHASE

OCCULDAS 23  
EL, Indireta, PHASE

117311 230

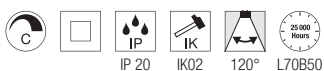
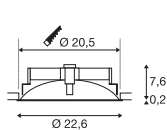
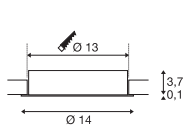

220-240V ~50/60Hz | 350mA  
Potência total: 15W  
Material: alumínio/aço

- Molas
- Espessura do teto falso: máx. 20 mm



Down 810lm | 3000K

Variante	Art. n.º	EUR
○ Branco	117331	167,00



220-240V ~50/60Hz | 700mA  
Potência total: 23W  
Material: alumínio/aço

- Molas
- Espessura do teto falso: máx. 30 mm



Down 1500lm | 3000K

Variante	Art. n.º	EUR
○ Branco	117311	308,00





**CONTONE®**  
DL, redondo, orientável, PHASE

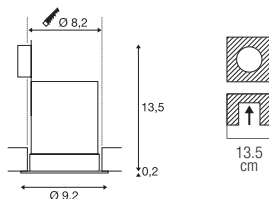

**CONTONE®**  
DL, redondo, fixo, PHASE

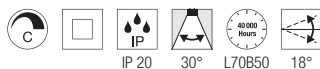
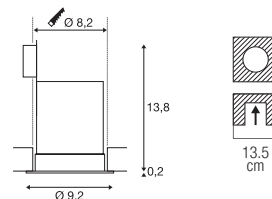

220-240V ~50/60Hz | 350mA  
Potência total: 15W  
Material: alumínio

- Molas
- Espessura do teto falso: máx. 25 mm



Down 1000lm | 2000-3000K

Variante	Art. n.º	EUR
○ Branco	161271	103,00

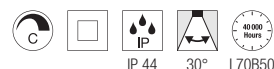

220-240V ~50/60Hz | 350mA  
Potência total: 15W  
Material: alumínio

- Molas
- Espessura do teto falso: máx. 25 mm



Down 1000lm | 2000-3000K

Variante	Art. n.º	EUR
○ Branco	161291	103,00



161271 231

H-LIGHT  
DL, Redondo, PHASE

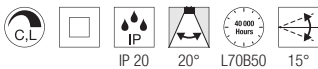
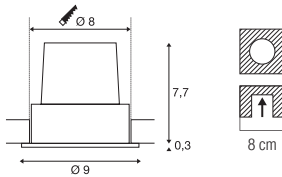

220-240V ~50/60Hz | 500mA  
Potência total: 11W  
Material: alumínio

- Molas
- Espessura do teto falso: máx. 30 mm



Down 265lm | 2700K

Variante	Art. n.º	EUR
● Preto	114480	91,00
○ Branco	114481	91,00

KARPO 30  
EL

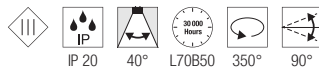
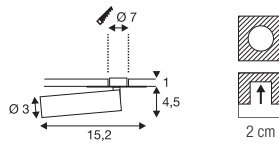

500mA  
Potência total: 7,5W  
Material: alumínio/aço

- Espessura do teto falso: máx. 12 mm. / Ao ligar várias luminárias, deve-se prestar atenção à ligação em série!
- Molas
- Com ficha elétrica AMP
- Espessura do teto falso: máx. 12 mm



Down 450lm | 470lm | 3000K

Variante	Art. n.º	EUR
● Preto		
450lm	152380	125,00
○ Branco		
470lm	152381	125,00



Artigo	Art. n.º	EUR
Driver 20W   350mA/500mA   regulável em fase		
○ Branco	1007227	40,00
Driver 25W   150-700mA   DALI		
○ Branco	1007229	70,00
Driver 21W   500mA incl. alívio de tensão		
○ Branco	1007226	30,00







148071 233

PLASTRA  
RL, Redondo, QPAR51

PLASTRA  
RL, quadrado, QPAR51

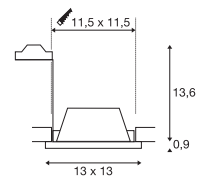
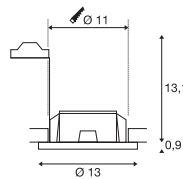

220-240V ~50/60Hz  
Material: gesso/aço

- Molas
- Espessura do teto falso: máx. 25 mm



220-240V ~50/60Hz  
Material: gesso/aço

- Molas
- Espessura do teto falso: máx. 30 mm



Casquilho: 1xGU10

Variante	Art. n.º	EUR
○ Branco	148070	42,25



Casquilho: 1xGU10

Variante	Art. n.º	EUR
○ Branco	148071	42,25



LED GU10 51mm | 6W | 36°  
2200-2700K | 360lm | EE=G  
6kWh/1000h



Art. N.º: 1005273 | 9,99 EUR



LED GU10 51mm | 6W | 38°  
2700K | 450lm | EE=F  
6kWh/1000h



Art. N.º: 1005076 | 7,50 EUR

DEKLED  
EL

VARU  
EL, QPAR51

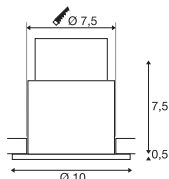
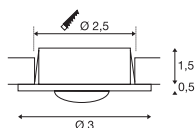

350mA  
Potência total: 1W  
Material: alumínio / policarbonato (PC)

- Molas



Down 60lm | 3000K

Variante	Art. n.º	EUR
● Cinzento	112242	31,25



Artigo	Art. n.º	EUR
Driver 350mA / 6W regulável em fase		
○ Branco	1002791	28,50

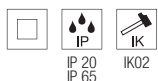

220-240V ~50/60Hz  
Material: alumínio/vidro

- Molas
- Espessura do teto falso: máx. 15 mm



Casquilho: 1xGU10 Máx. Ø: 5,1 cm

Variante	Art. n.º	EUR
● Preto	1001930	41,00
○ Branco	1001931	41,00



LED GU10 51mm | 6W | 38°  
2700K | 450lm | EE=F  
6kWh/1000h



Art. N.º: 1005077 | 7,50 EUR

1001931 234



1001931 234





1001165 235



**DOLIX OUT**  
EL, Redondo, QPAR51

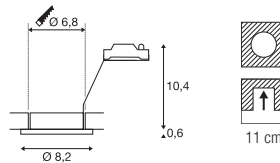

**DOLIX OUT**  
EL, quadrado, QPAR51

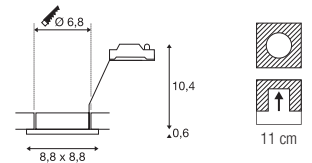

1001166 235

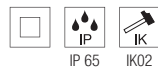

220-240V ~50/60Hz  
Material: alumínio/vidro

- Molas
- Espessura do teto falso: máx. 20 mm



Casquilha: 1xGU10

Variante	Art. n.º	EUR
○ Branco	1001165	35,50
● Prateado	1001168	39,50
● Cromado	1001166	39,50
● Cinzento	1001167	35,50



LED GU10 51mm | 6W | 36°  
2200-2700K | 360lm | EE=G  
6kWh/1000h

Art. N.º: 1005273 | 9,99 EUR

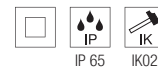

220-240V ~50/60Hz  
Material: alumínio/vidro

- Molas
- Espessura do teto falso: máx. 20 mm



Casquilha: 1xGU10

Variante	Art. n.º	EUR
○ Branco	1001169	35,50
● Prateado	1001172	39,50
● Cinzento	1001171	35,50



LED GU10 51mm | 6W | 36°  
2200-2700K | 360lm | EE=G  
6kWh/1000h

Art. N.º: 1005273 | 9,99 EUR



1001015 236



## KAMUELA ECO EL, redondo, PHASE

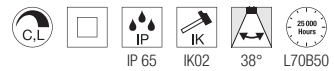
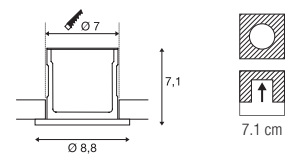

220-240V ~50Hz  
Potência total: 6W  
Material: alumínio/plástico

- Molas
- Espessura do teto falso: máx. 40 mm
- Resistente ao fogo durante no mín. 90 minutos, em conformidade com BS 476-21



Down

500lm | 3000K

Variante	Art. n.º	EUR
● Preto	1001015	35,50
○ Branco	1001016	35,50

1001017 237

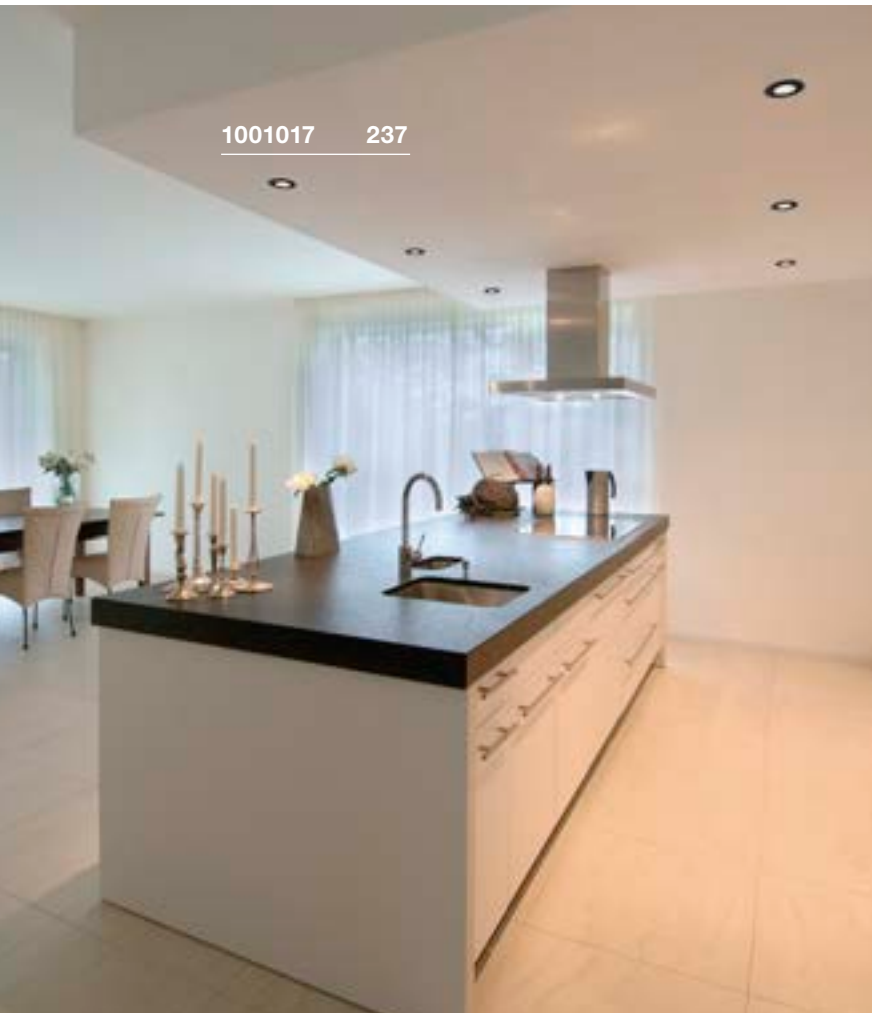



### KAMUELA ECO EL, redondo, PHASE

### KINI EL, PHASE

### AKALO D83 EL

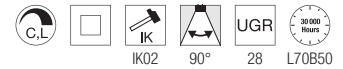
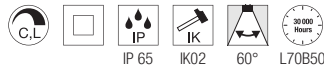
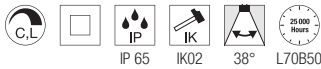
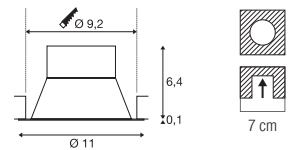
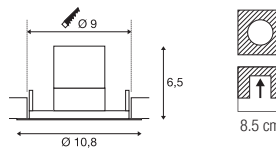
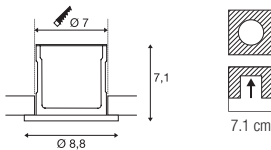

220-240V ~50Hz  
Potência total: 6W  
Material: alumínio/plástico

- Molas
- Espessura do teto falso: máx. 40 mm
- Resistente ao fogo durante no mín. 90 minutos, em conformidade com BS 476-21

220-240V ~50/60Hz | 260mA  
Potência total: 12W  
Material: alumínio / policarbonato (PC)

- Molas
- Espessura do teto falso: máx. 20 mm

220-240V ~50/60Hz | 120mA  
Potência total: 9W  
Material: alumínio / policarbonato (PC)

- Molas
- Espessura do teto falso: máx. 20 mm



Down 530lm | 4000K



Down 850lm | 3000K



800lm | 3000K | 880lm | 4000K | 850lm | 5700K

Variante	Art. n.º	EUR
● Preto	1001017	35,50
○ Branco	1001018	35,50

Variante	Art. n.º	EUR
○ Branco	1000833	103,00

Variante	Art. n.º	EUR
○ Branco	1001264	40,25

## FRAME BASIC SET RL

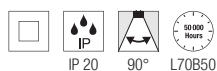
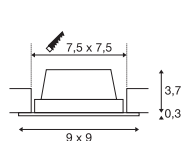

220-240V ~50/60Hz | 350mA  
Potência total: 8,3W  
Material: alumínio/acrílico

- Molas
- Espessura do teto falso: máx. 20 mm



Down 600lm | 3000K

Variante	Art. n.º	EUR
● Preto	112720	54,00
○ Branco	112721	54,00

## FRAME BASIC RL, HV

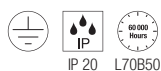
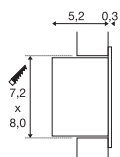

100-240V ~50/60Hz | 350mA  
Potência total: 3W  
Material: alumínio

- Espessura do teto falso/parede: máx. 30 mm



Down 170lm | 2700K

Variante	Art. n.º	EUR
○ Branco	1000576	71,00
● Cinzento	1000577	71,00



Artigo	Art. n.º	EUR
Caixa de encastrar para paredes mAcças		
● Preto	112781	10,90
Estrutura para paredes ocas		
● Dourado	112780	6,35

## FRAME BASIC

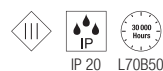
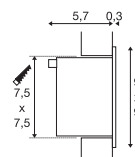

350mA  
Potência total: 1W  
Material: alumínio/vidro

- Ao ligar várias luminárias, deve-se prestar atenção à ligação em série!
- Com ficha elétrica AMP
- Espessura da parede: máx. 30 mm



Down 40lm | 3000K

Variante	Art. n.º	EUR
○ Branco	113262	40,00
● Cinzento	111262	40,00



Artigo	Art. n.º	EUR
Caixa de encastrar para paredes mAcças		
● Preto	112781	10,90
Extensão de cabo: 1 m		
○ Branco	111861	7,75
Driver 3W   350mA inclui ficha AMP		
○ Branco	1007270	19,80
Extensão elétrica de 3 tomadas, inclui fichas AMP		
● Preto	111850	13,40
Estrutura para paredes ocas		
● Dourado	112780	6,35



## FRAME CURVE EL

## FRAME CURVE EL

1000575 239

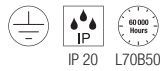
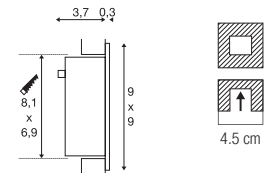
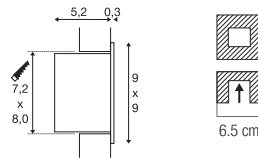

IP 20 L70B50

100-240V ~50/60Hz | 350mA  
Potência total: 3W  
Material: alumínio

- Lamelas
- Espessura do teto falso/parede: máx. 30 mm



Down 140lm | 2700K

Variante	Art. n.º	EUR
○ Branco	1000574	77,00
● Cinzento	1000575	77,00



Artigo	Art. n.º	EUR
Caixa de encastrar para paredes mAciaças		
● Preto	112781	10,90
Estrutura para paredes ocas		
● Dourado	112780	6,35

1000577 238

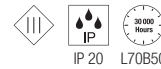

IP 20 L70B50

350mA  
Potência total: 1W  
Material: alumínio

- Ao ligar várias luminárias, deve-se prestar atenção à ligação em série!
- Lamelas
- Com ficha elétrica AMP
- Espessura da parede: máx. 25 mm



Down 60lm | 3000K

Variante	Art. n.º	EUR
○ Branco	113292	54,00
● Cinzento	111292	54,00



Artigo	Art. n.º	EUR
Caixa de encastrar para paredes mAciaças		
● Preto	112781	10,90
Extensão de cabo: 1 m		
○ Branco	111861	7,75
Driver 3W   350mA inclui ficha AMP		
○ Branco	1007270	19,80
Extensão elétrica de 3 tomadas, inclui fichas AMP		
● Preto	111850	13,40
Estrutura para paredes ocas		
● Dourado	112780	6,35

# QUAD FRAME 9 WL

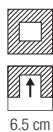
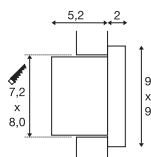

L70B50

100-240V ~50/60Hz | 350mA

Potência total: 3W

Material: alumínio

- Espessura da parede: máx. 30 mm



Down

75lm | 3000K

Variante	Art. n.º	EUR
<input type="radio"/> Branco	1003466	92,00



Artigo	Art. n.º	EUR
Caixa de encastrar para paredes mAciaças		
<input checked="" type="radio"/> Preto	112781	10,90
Estrutura para paredes ocas		
<input checked="" type="radio"/> Dourado	112780	6,35

1003466 240







## NOTAPO S RL

## NOTAPO L RL



1002979 241

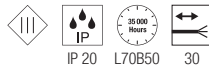
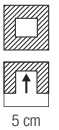
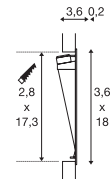
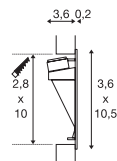

IP 20 L70B50 30

700mA  
Consumo de energia: 2,2W  
Material: alumínio

- Ao ligar várias luminárias, deve-se prestar atenção à ligação em série!
- Lamelas
- Extremidade do cabo aberta

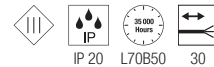

IP 20 L70B50 30

700mA  
Consumo de energia: 2,2W  
Material: alumínio

- Ao ligar várias luminárias, deve-se prestar atenção à ligação em série!
- Lamelas
- Extremidade do cabo aberta

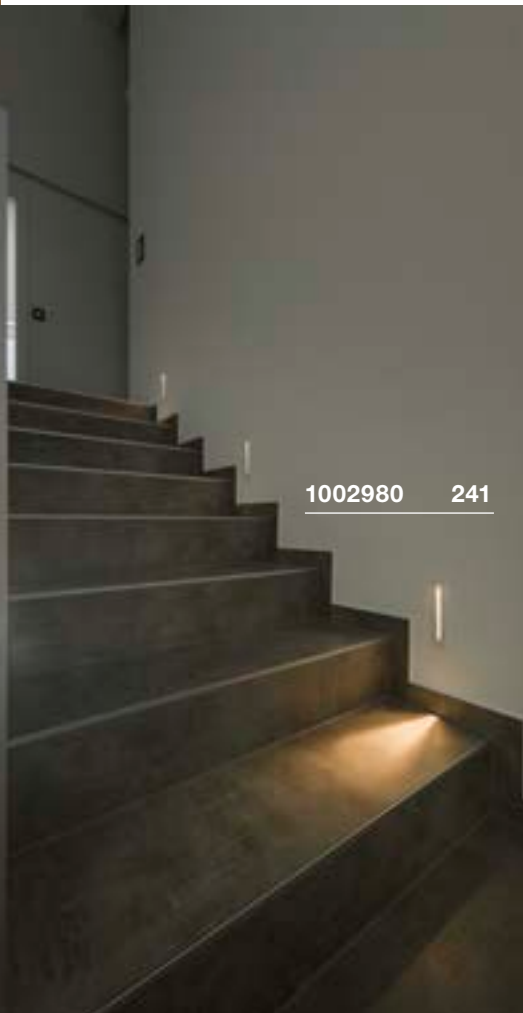

1002980 241



Down 6lm | 3000K

Variante	Art. n.º	EUR
○ Branco	1002979	60,00



Artigo	Art. n.º	EUR
Driver 25W   150-700mA   DALI		
○ Branco	1007229	70,00
Driver 3W   700mA incl. alívio de tensão		
○ Branco	1007216	23,00
NOTAPO   Caixa de montagem para encastrar		
● Preto	1002981	24,25



Down 6lm | 3000K

Variante	Art. n.º	EUR
○ Branco	1002980	82,00



Artigo	Art. n.º	EUR
Driver 10W   700mA   regulável em fase, incl. alívio de tensão		
○ Branco	1007213	35,00
Driver 3W   700mA incl. alívio de tensão		
○ Branco	1007216	23,00
NOTAPO   Caixa de montagem para encastrar		
● Preto	1002981	24,25

## DOWNUNDER PUR 80 EL

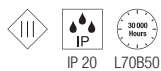
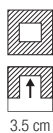
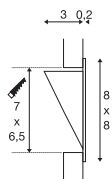

350mA  
Potência total: 3,6W  
Material: alumínio/aço

- Ao ligar várias luminárias, deve-se prestar atenção à ligação em série!
- Lamelas



Down 180lm | 3000K

Variante	Art. n.º	EUR
<input type="radio"/> Branco	151950	60,00



Artigo	Art. n.º	EUR
Estrutura para		
● Cinzento	151960	9,05
Extensão de cabo: 1 m		
<input type="radio"/> Branco	111861	7,75
Driver 3W   350mA incl. conector AMP		
<input type="radio"/> Branco	1007270	19,80
Extensão elétrica de 3 tomadas, inclui fichas AMP		
● Preto	111850	13,40

## DOWNUNDER PUR 150 EL

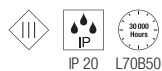
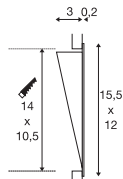

500mA  
Potência total: 5,2W  
Material: alumínio/aço

- Ao ligar várias luminárias, deve-se prestar atenção à ligação em série!
- Lamelas



Down 230lm | 3000K

Variante	Art. n.º	EUR
<input type="radio"/> Branco	151952	86,00



Artigo	Art. n.º	EUR
Caixa de montagem para encastrar		
● Cinzento	151962	12,90
Driver 20W   350mA/500mA   regulável em fase		
<input type="radio"/> Branco	1007227	40,00
Driver 25W   150-700mA   DALI		
<input type="radio"/> Branco	1007229	70,00
Driver 21W   500mA incl. alívio de tensão		
<input type="radio"/> Branco	1007226	30,00

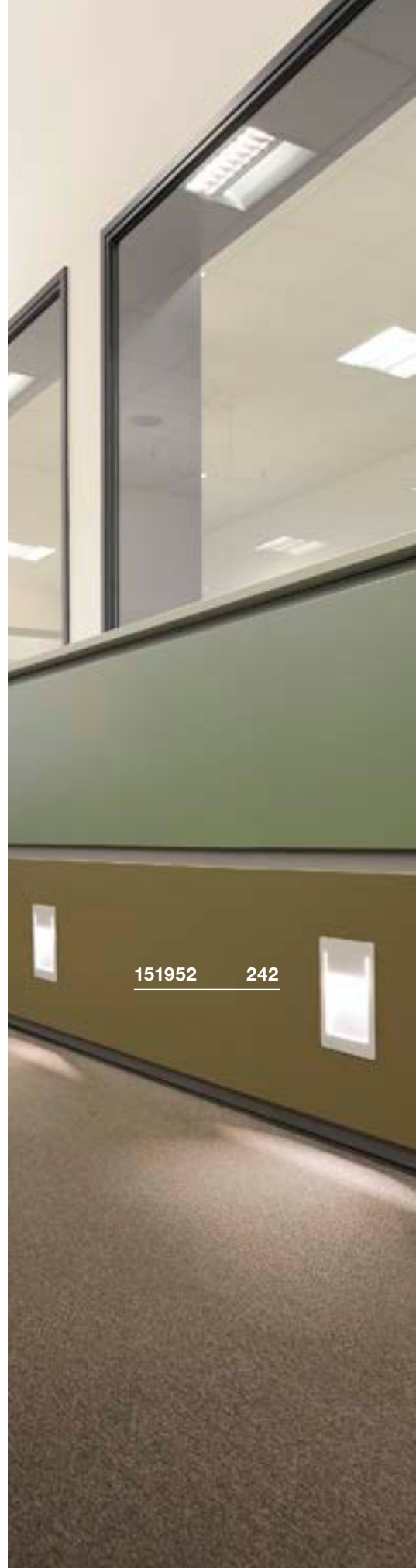

151952

242



## MOBALA EL

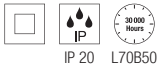
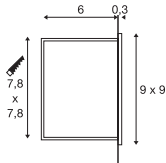

100-240V ~50/60Hz  
Potência total: 1,3W  
Material: alumínio

- Para a correta instalação é necessária o aro de fixação para paredes ocas (1002984) ou a caixa de embutir para paredes maciças (1002983).
- Lamelas



Down 14lm | 3000K

Variante	Art. n.º	EUR
<input type="radio"/> Branco	1002982	72,00



Artigo	Art. n.º	EUR
Driver 3W   350mA		
<input type="radio"/> Branco	1005248	15,00

## WORO EL

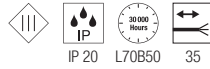
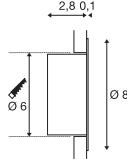

350mA  
Potência total: 1,2W  
Material: aço

- Ao ligar várias luminárias, deve-se prestar atenção à ligação em série!
- O artigo é adequado para instalação em caixas de aparelhagem de parede oca.
- Lamelas
- Extremidade do cabo aberta



Down 50lm | 3000K

Variante	Art. n.º	EUR
<input type="radio"/> Branco	1002922	70,00



Artigo	Art. n.º	EUR
Driver 20W   350mA/500mA   regulável em fase		
<input type="radio"/> Branco	1007227	40,00

## LED PANEL 620x620mm

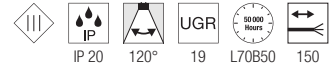
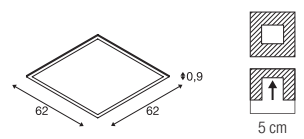

1050mA  
Consumo de energia: 35W  
Material: alumínio/poliestireno (PS)

- Extremidade do cabo aberta



Down 4000lm | 3000K  
4000K

Variante	Art. n.º	EUR
<input type="radio"/> Branco		
3000K	1003073	202,00
<input type="radio"/> Branco		
4000K	1003074	202,00



Artigo	Art. n.º	EUR
Conjunto de suspensão 1,5 m		
<input checked="" type="radio"/> Cromado	158799	20,00
Driver 40W   1050mA DALI regulável com interface RF		
<input type="radio"/> Branco	1006197	100,00
Driver 40W   1050mA regulável em fase, incl. alívio de tensão		
<input type="radio"/> Branco	464804	57,00
Módulo de RF para controlador DALI		
<input type="radio"/> Branco	1006454	129,00
Módulo de RF para controlador DALI		
<input type="radio"/> Branco	1006199	38,00

PATTA-I  
EL, redondo, PHASE

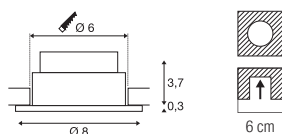

220-240V ~50/60Hz | 350mA  
Potência total: 7,3W  
Material: alumínio/vidro

- Molas. As lamelas acompanham o produto.
- Espessura do teto falso: máx. 20 mm



Down 440lm | 1800-3000K

Variante	Art. n.º	EUR
● Preto	1002098	86,00
○ Branco	1002099	86,00
● Alumínio	1002100	90,00

PATTA-I  
DL, quadrado, PHASE

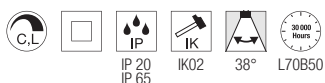
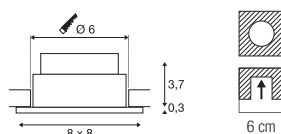

220-240V ~50/60Hz | 350mA  
Potência total: 7,3W  
Material: alumínio/vidro

- Molas. As lamelas acompanham o produto.
- Espessura do teto falso: máx. 20 mm



Down 440lm | 1800-3000K

Variante	Art. n.º	EUR
● Preto	1002101	86,00
○ Branco	1002102	86,00

1002099 244



1002101 244





1002098 244



PATTA-I  
EL, redondo, PHASE

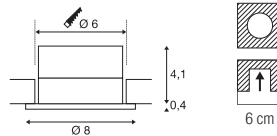

PATTA-I  
EL, quadrado, PHASE

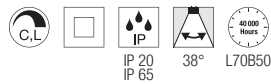
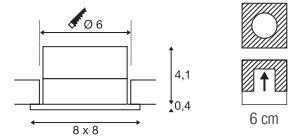

220-240V ~50/60Hz | 500mA  
Potência total: 11W  
Material: alumínio/vidro

- Molas
- Espessura do teto falso: máx. 25 mm

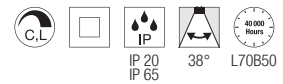

220-240V ~50/60Hz | 500mA  
Potência total: 11W  
Material: alumínio/vidro

- Molas
- Espessura do teto falso: máx. 25 mm

114431 245

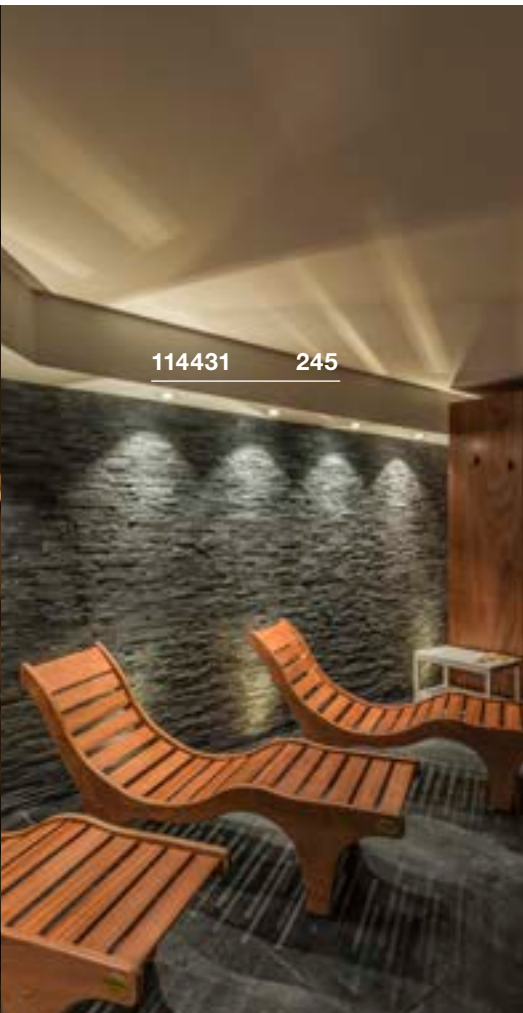

Down 910lm | 3000K

Variante	Art. n.º	EUR
● Preto	114420	86,00
○ Branco	114421	86,00
● Alumínio	114426	90,00



Down 910lm | 3000K

Variante	Art. n.º	EUR
● Preto	114430	86,00
○ Branco	114431	86,00
● Alumínio	114436	90,00

114451 247

PATTA-F  
EL, redondo, PHASE

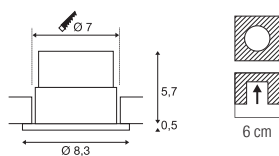

220-240V ~50/60Hz | 500mA

Potência total: 11W

Material: alumínio/vidro

- Molas
- Espessura do teto falso: máx. 20 mm



Down 745lm | 3000K  
860lm

Variante	Art. n.º	EUR
● Preto 745lm	114440	97,00
○ Branco 860lm	114441	97,00





114450 247

PATTA-F  
EL, quadrado, PHASE

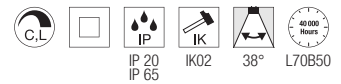
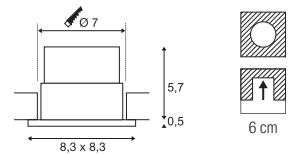

220-240V ~50/60Hz | 500mA  
Potência total: 11W  
Material: alumínio/vidro

- Molas
- Espessura do teto falso: máx. 20 mm



Down 745lm | 860lm 3000K

Variante	Art. n.º	EUR
● Preto 745lm	114450	97,00
○ Branco 860lm	114451	97,00







Encontre a família **NUMINOS®** nas páginas 102–105



Encontre a família **MEDO®** nas páginas 164–165



**SCKET**  
VARYT | 251



**LED**  
Q-LINE® | 253



**LED**  
Q-LINE® | 253



**SCKET**  
TRILEDO | 255



**SCKET**  
TRILEDO | 255



**SCKET**  
TRILEDO | 255



**LED**  
TRILEDO | 257



**LED**  
TRILEDO | 257



**LED**  
TRILEDO | 257



**LED**  
OCULUS | 258



**SCKET**  
ENOLA B | 259



**LED**  
ENOLA C | 259



**SCKET**  
ASTINA | 261



**SCKET**  
NAGY 75 | 261



**LED**  
ANELA | 261



**LED**  
OCCULDAS 13 | 262



**LED**  
OCCULDAS 23 | 262



**SCKET**  
ALTRA DICE | 263



**SCKET**  
ALTRA DICE | 263



**SCKET**  
KARDAMOD | 265



**SCKET**  
KARDAMOD | 265



**SCKET**  
FENDA | 266



**FENDA** | 267



**FENDA** | 267



**FENDA** | 267



**SCKET**  
TENORA | 268



**SCKET**  
SOPRANA | 269



**SCKET**  
PLASTRA | 270



**LED**  
PLASTRA | 271



**SCKET**  
PLASTRA 105 | 271



**SCKET**  
PLASTRA 104 | 271



**LED**  
FERA 25 | 272



**LED**  
FERA 25 | 272



**LED**  
MARONA | 273



**LED**  
PANEL 60 | 274



**LED**  
PANEL | 275



**LED**  
PANEL 60 | 275



**LED**  
PANEL | 275

1007605 251





VARYT  
CL, E14

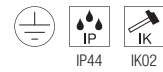
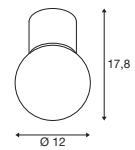

220-240V ~50/60Hz  
Material: alumínio



Casquilho: 1xE14 Máx. Ø: 3,8 cm C: 11 cm

Variante	Art. n.º	EUR
● Preto	1007607	159,00
○ Branco	1007606	159,00
● Cromado	1007604	180,00
● Bronze	1007605	189,00



E14 C35 | 4,2W | 320°  
2700K | 350lm | EE=G  
5kWh/1000h



Art. N.º: 1005285 | 8,50 EUR



1000692 253

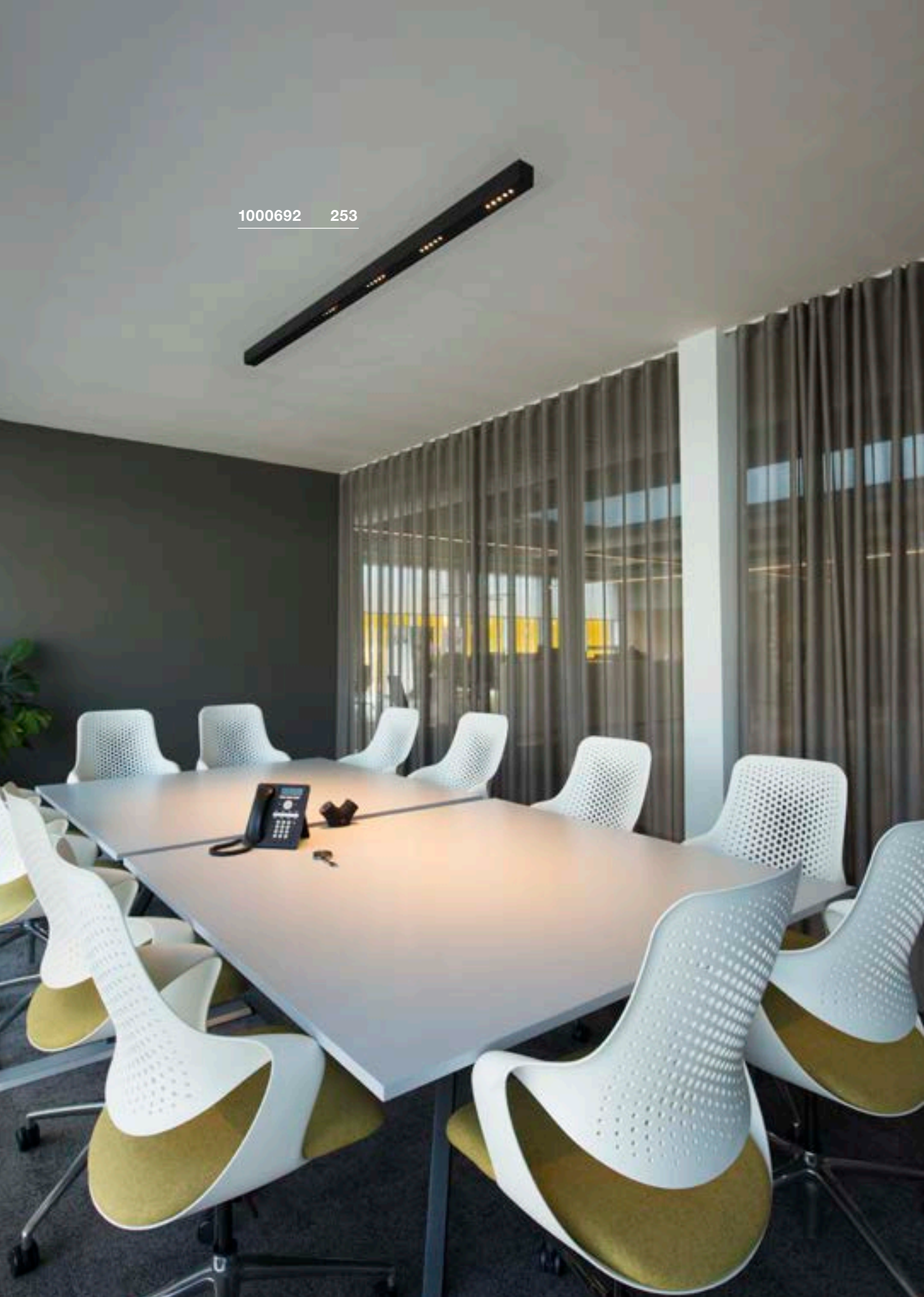



Q-LINE®  
CL, 1m, BAP, PHASE

Q-LINE®  
CL, 2m, BAP, PHASE

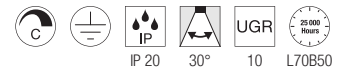
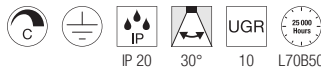
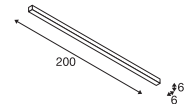
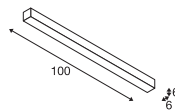

220-240V ~50/60Hz | 900mA  
Potência total: 46W  
Material: alumínio/plástico

220-240V ~50/60Hz | 900mA  
Potência total: 93W  
Material: alumínio/plástico



Down 2100lm | 3000K  
2300lm | 4000K

Down 4200lm | 3000K  
4600lm | 4000K

Variante	Art. n.º	EUR
● Preto		
2100lm   3000K	<b>1000686</b>	<b>464,00</b>
○ Branco		
2100lm   3000K	<b>1000685</b>	<b>464,00</b>
● Preto		
2300lm   4000K	<b>1000689</b>	<b>464,00</b>
○ Branco		
2300lm   4000K	<b>1000688</b>	<b>464,00</b>

Variante	Art. n.º	EUR
● Preto		
4200lm   3000K	<b>1000692</b>	<b>696,00</b>
○ Branco		
4200lm   3000K	<b>1000691</b>	<b>696,00</b>
● Preto		
4600lm   4000K	<b>1000695</b>	<b>696,00</b>
○ Branco		
4600lm   4000K	<b>1000694</b>	<b>696,00</b>

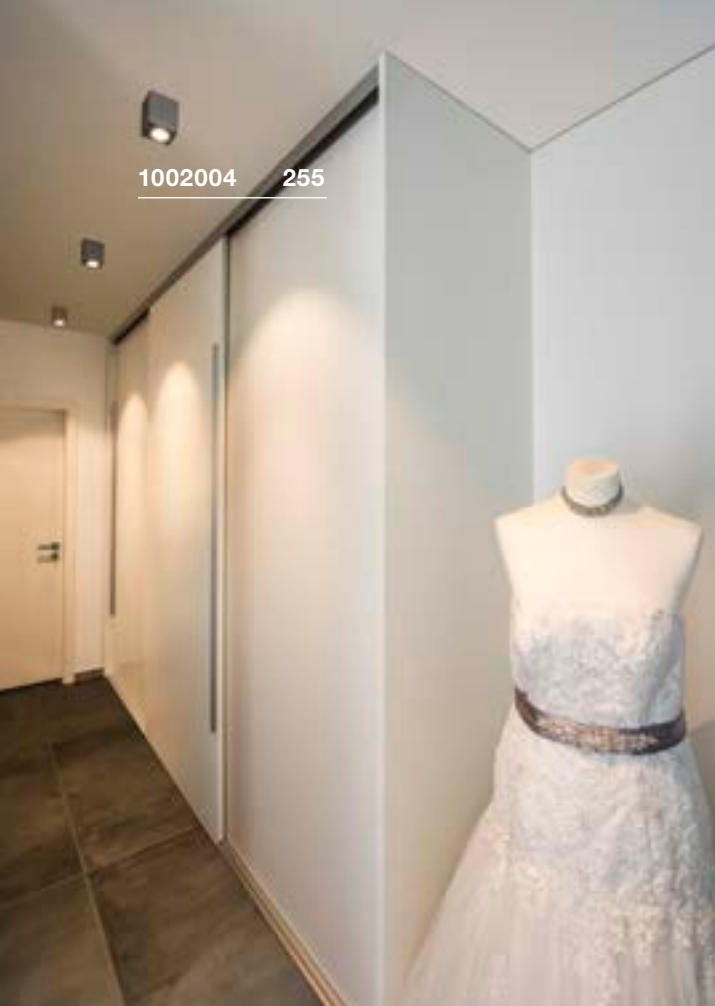

1002004 255



1002011 255



1002005 255



**TRILEDO**  
CL, single, quadrado, QPAR51

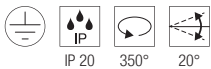
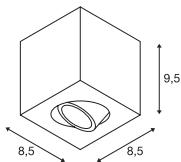

220-240V ~50/60Hz  
Material: alumínio



Casquilho: 1xGU10 Máx. Ø: 5,1 cm C: 5,5 cm

Variante	Art. n.º	EUR
● Preto	1002013	73,00
○ Branco	1002015	73,00
● Alumínio	1002004	78,00



LED GU10 51mm | 6W | 38°  
2700K | 450lm | EE=F  
6kWh/1000h



Art. N.º: 1005075 | 7,50 EUR

**TRILEDO**  
CL, double, quadrado, QPAR51

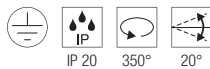
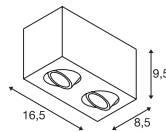

220-240V ~50/60Hz  
Material: alumínio



Casquilho: 2xGU10 Máx. Ø: 5,1 cm C: 5,5 cm

Variante	Art. n.º	EUR
● Preto	1002005	107,00
○ Branco	1002006	107,00



LED GU10 51mm | 6W | 38°  
2700K | 450lm | EE=F  
6kWh/1000h



Art. N.º: 1005077 | 7,50 EUR

**TRILEDO**  
CL, single, redondo, QPAR51

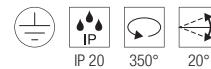
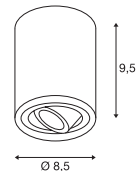

220-240V ~50/60Hz  
Material: alumínio



Casquilho: 1xGU10 Máx. Ø: 5,1 cm C: 5,5 cm

Variante	Art. n.º	EUR
● Preto	1002010	73,00
○ Branco	1002011	73,00
● Alumínio	1002012	78,00



LED GU10 51mm | 6W | 38°  
2700K | 450lm | EE=F  
6kWh/1000h



Art. N.º: 1005075 | 7,50 EUR

113940 257



113931 257



1002003 257







**TRILEDO**  
CL, single, quadrado

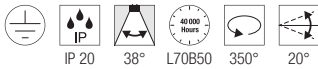
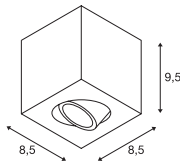

220-240V ~50/60Hz | 350mA  
Potência total: 7,6W  
Material: alumínio/alumínio



Down 640lm | 3000K

Variante	Art. n.º	EUR
● Preto	113940	117,00
○ Branco	113941	117,00

**TRILEDO**  
CL, double, quadrado

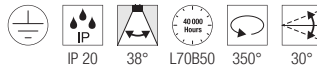
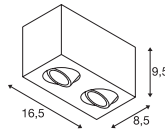

220-240V ~50/60Hz | 350mA  
Potência total: 14W  
Material: alumínio



Down 1300lm | 3000K

Variante	Art. n.º	EUR
● Preto	1002003	163,00
○ Branco	1002008	163,00

**TRILEDO**  
CL, single, redondo

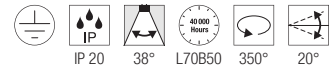
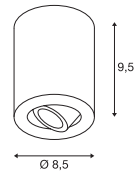

220-240V ~50/60Hz | 350mA  
Potência total: 7,6W  
Material: alumínio/alumínio



Down 640lm | 3000K

Variante	Art. n.º	EUR
● Preto	113930	117,00
○ Branco	113931	117,00

# OCULUS CL, PHASE

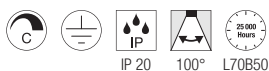
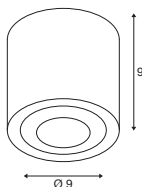

220-240V ~50/60Hz | 250mA  
Potência total: 11W  
Material: alumínio/vidro

- Inclui difusor fosco adicional



Down 36lm | 2000K - 780lm | 3000K

Variante	Art. n.º	EUR
● Preto	1004666	229,00
○ Branco	1004667	229,00

1004667 258

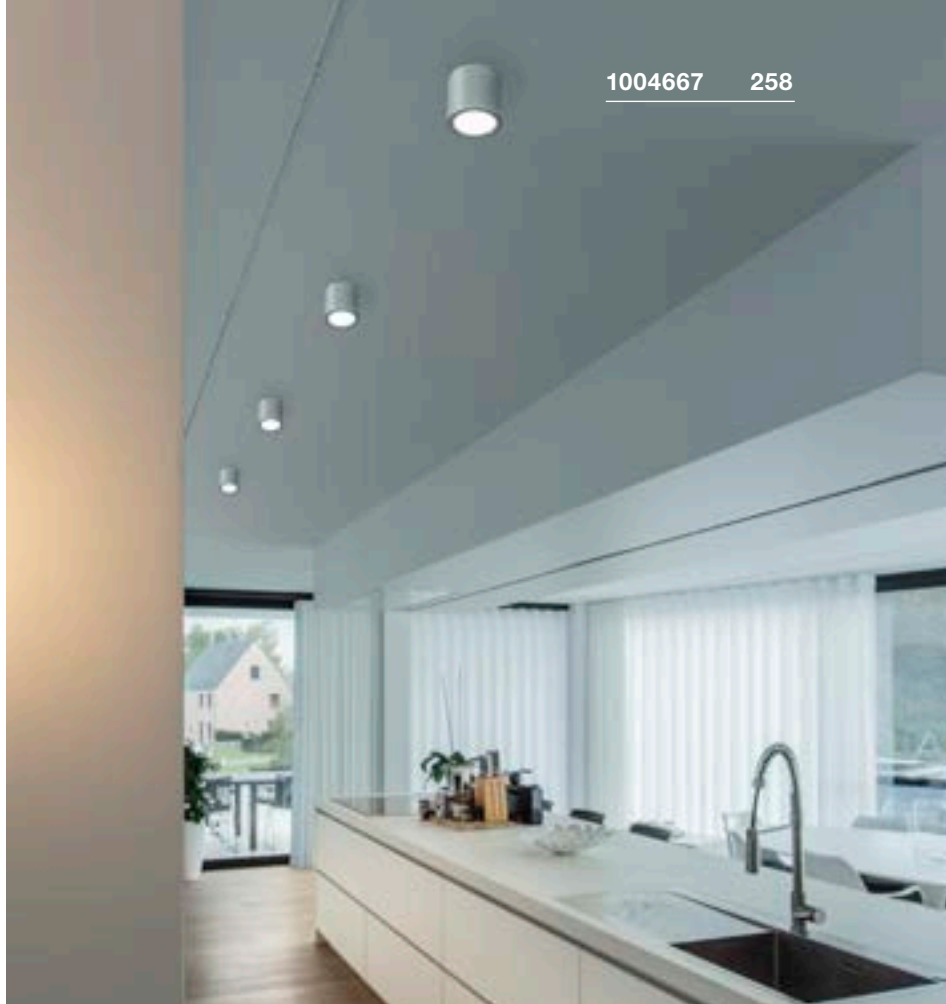

151811 259





## ENOLA B CL, QPAR51

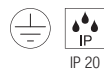
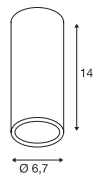

220-240V ~50/60Hz  
Material: alumínio



Casquilho: 1xGU10

Máx. C: 8,5 cm

Variante	Art. n.º	EUR
● Preto	151810	53,00
○ Branco	151811	53,00



LED GU10 51mm | 6W | 36°  
2200-2700K | 360lm | EE=G  
6kWh/1000h



Art. N.º: 1005273 | 9,99 EUR



Artigo	Art. n.º	EUR
Anel decorativo		
● Preto	151840	8,95

## ENOLA C CL

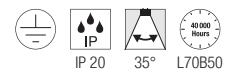
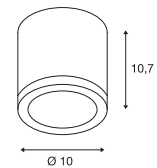

220-240V ~50/60Hz | 500mA  
Potência total: 11W  
Material: alumínio



Down

1020lm | 3000K

Variante	Art. n.º	EUR
○ Branco	152101	198,00



1002936 261



1002965 261



1000808 261





ASTINA  
CL, QPAR51

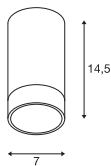

220-240V ~50/60Hz  
Material: alumínio



Casquilho: 1xGU10

Variante	Art. n.º	EUR
● Preto	1002936	88,00
○ Branco	1002934	88,00



LED GU10 51mm | 6W | 38°  
2700K | 450lm | EE=F  
6kWh/1000h



Art. N.º: 1005075 | 7,50 EUR

NAGY 75  
CL, QPAR51

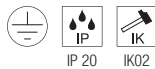
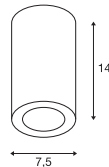

220-240V ~50/60Hz  
Material: gesso



Casquilho: 1xGU10

Variante	Art. n.º	EUR
○ Branco	1002965	57,00



LED GU10 51mm | 6W | 36°  
2200-2700K | 360lm | EE=G  
6kWh/1000h



Art. N.º: 1005273 | 9,99 EUR

ANELA  
CL, PHASE

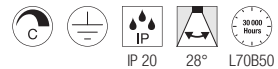
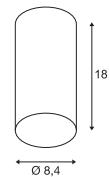

220-240V ~50/60Hz | 500mA  
Potência total: 10W  
Material: alumínio



Down 220lm | 3000K | 750lm | 3000K

Variante	Art. n.º	EUR
● Preto	1000807	156,00
○ Branco	1000808	156,00



Artigo	Art. n.º	EUR
Refletor 28°		
● Preto	1000811	19,75
○ Branco	1000812	19,75
● Dourado	1000809	19,75
● Cinzento	1000810	19,75

OCCULDAS 13  
CL, indireto, PHASE

OCCULDAS 23  
CL, indireto, PHASE

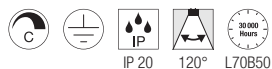
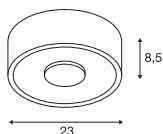
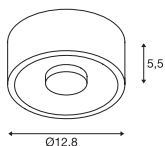

220-240V ~50/60Hz | 350mA  
Potência total: 15W  
Material: alumínio

220-240V ~50/60Hz | 700mA  
Potência total: 24W  
Material: alumínio/aço



Down 810lm | 3000K



Down 1500lm | 3000K

Variante	Art. n.º	EUR
○ Branco	117351	202,00

Variante	Art. n.º	EUR
○ Branco	117321	333,00



117321 262



1002216 263



ALTRA DICE  
CL, QPAR51

ALTRA DICE  
CW, double, QPAR51

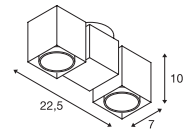
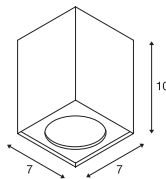

1002215 263



220-240V ~50/60Hz  
Material: alumínio/aço



Casquilho: 1xGU10

Variante	Art. n.º	EUR
● Preto	1002216	60,00
○ Branco	151511	60,00
●● Cinzento/preto	151514	60,00



LED GU10 51mm | 6W | 38°  
2700K | 450lm | EE=F  
6kWh/1000h



Art. N.º: 1005077 | 7,50 EUR

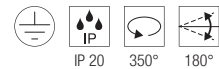

220-240V ~50/60Hz  
Material: alumínio/aço



Casquilho: 2xGU10

Variante	Art. n.º	EUR
● Preto	1002215	109,00
○ Branco	151531	109,00
● Cinzento	151534	109,00



LED GU10 51mm | 6W | 36°  
2200-2700K | 360lm | EE=G  
6kWh/1000h



Art. N.º: 1005273 | 9,99 EUR

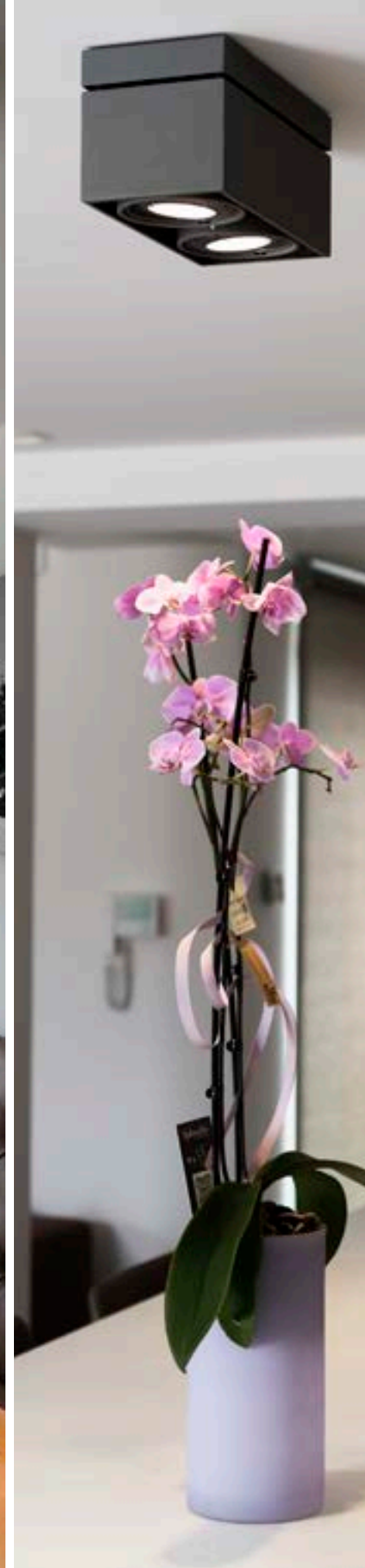





**KARDAMOD**  
CL, single, quadrado, QPAR111

**KARDAMOD**  
CL, double, quadrado, QPAR111

117110 265

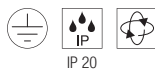
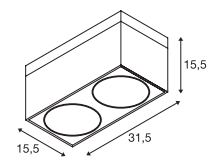
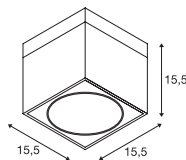

IP 20

220-240V ~50/60Hz  
Material: aço



Casquilho: 1xGU10

Variante	Art. n.º	EUR
● Preto	117100	141,00
○ Branco	117101	141,00



QPAR111 | 12,5W | 30°  
2700K | 950lm | EE=F  
13kWh/1000h



Art. N.º: 1005276 | 49,50 EUR

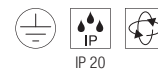

IP 20

220-240V ~50/60Hz  
Material: aço



Casquilho: 2xGU10

Variante	Art. n.º	EUR
● Preto	117110	252,00
○ Branco	117111	252,00



QPAR111 | 8W | 38°  
2700K | 680lm | EE=F  
8kWh/1000h



Art. N.º: 1005274 | 30,75 EUR

FENDA  
Roseta para teto, E27

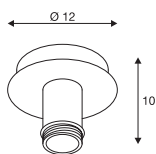

220-240V ~50/60Hz  
Material: aço



Casquilho: 1xE27

Variante	Art. n.º	EUR
● Preto	155550	46,75
○ Branco	155551	46,75



LED E27 | 7,5W | 320°  
2700K | 800lm | EE=F  
8kWh/1000h



Art. N.º: 1005268 | 12,25 EUR

155551 + 1004775 266 + 267





FENDA  
30 cm, redondo



A: 20 cm  
Ø: 30 cm  
Material: têxtil/aço

FENDA  
Ø 45 cm, redondo



A: 28 cm  
Ø: 45,5 cm  
Material: têxtil/aço

FENDA  
Ø 70 cm, redondo



A: 36 cm  
Ø: 70 cm  
Material: têxtil/aço

• Não é adequado para Fenda Bow.

Variante	Art. n.º	EUR
●● Preto/cobre	155592	70,00
○ Branco	155582	53,00
● Cinzento	1004774	53,00
● Bege	155583	53,00

Variante	Art. n.º	EUR
●● Preto/cobre	156122	88,00
○ Branco	156111	83,00
● Cinzento	1004775	83,00
● Bege	156113	83,00

Variante	Art. n.º	EUR
●● Preto/cobre	1000580	129,00
○ Branco	1000579	112,00



156050 268

## TENORA CL, E27

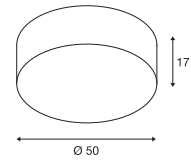

IP 20

220-240V ~50/60Hz  
Material: aço/têxtil

**SOCKET  
INSIDE**

<23  
W

Casquilhos: 3xE27

Máx. C: 14,8 cm

Variante	Art. n.º	EUR
● Preto	156050	187,00
○ Branco	156051	187,00



LED E27 | 13,2W | 220°  
2700K | 1300lm | EE=F  
13kWh/1000h



Art. N.º: 1005302 | 12,25 EUR



SOPRANA  
CL, E27

155373 269

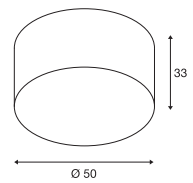

220-240V ~50/60Hz  
Material: aço/têxtil



Casquilhos: 3xE27

Variante	Art. n.º	EUR
● Bege	155373	206,00



A60 | 7,5W | 320°  
2700K | 800lm | EE=F  
8kWh/1000h



Art. N.º: 1005303 | 9,60 EUR

148004 270



PLASTRA  
CL, QPAR51

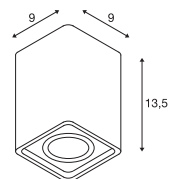

148005 271



220-240V ~50/60Hz  
Material: gesso/aço

**SOCKET** **INSIDE** <35  
W

Casquilha: 1xGU10

Variante	Art. n.º	EUR
○ Branco	148004	67,00



LED GU10 51mm | 6W | 38°  
2700K | 450lm | EE=F  
6kWh/1000h



Art. N.º: 1005077 | 7,50 EUR



PLASTRA  
CL, PHASE

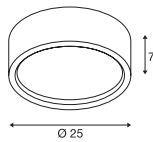

220-240V ~50/60Hz | 350mA  
Potência total: 15W  
Material: gesso/vidro



Down 990lm | 3000K

Variante	Art. n.º	EUR
○ Branco	148005	133,00

PLASTRA 105  
CL, E27

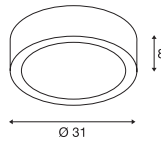

220-240V ~50/60Hz  
Material: gesso/vidro



Casquilhos: 2xE27 Máx. Ø: 5,1 cm | C: 14 cm

Variante	Art. n.º	EUR
○ Branco / Transp.	148001	91,00



LED E27 | 8W | 240°  
4000K | 920lm | EE=E  
8kWh/1000h

Art. N.º: 1005290 | 10,25 EUR



PLASTRA 104  
CL, E27

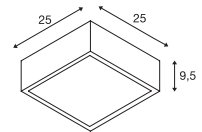

220-240V ~50/60Hz  
Material: gesso/vidro



Casquilhos: 2xE27 Máx. Ø: 5,1 cm | C: 14 cm

Variante	Art. n.º	EUR
○ Branco / Transp.	148002	85,00



LED E27 | 8W | 240°  
4000K | 920lm | EE=E  
8kWh/1000h

Art. N.º: 1005290 | 10,25 EUR



FERA 25  
CL, DALI

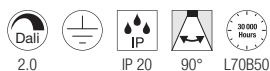
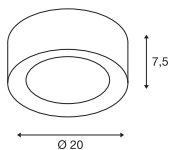

220-240V ~50/60Hz | 500mA  
Potência total: 20W  
Material: policarbonato (PC)/  
polimetilacrilato (PMMA)



Down 1580lm | 3000K | 1650lm | 4000K

Variante	Art. n.º	EUR
● Preto	1002968	272,00
○ Branco	1002967	272,00

FERA 25  
CL

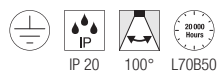
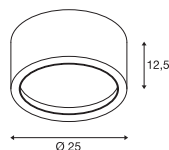

220-240V ~50/60Hz | 550mA  
Potência total: 23W  
Material: alumínio/poliestireno (PS)



Down 1800lm | 3000K

Variante	Art. n.º	EUR
● Preto	1001939	201,00
○ Branco	161461	201,00

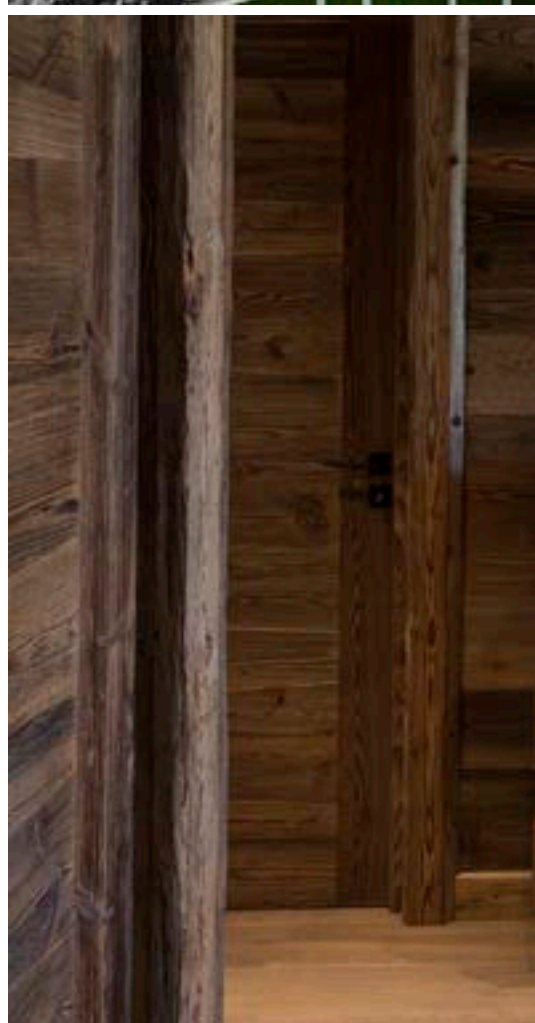
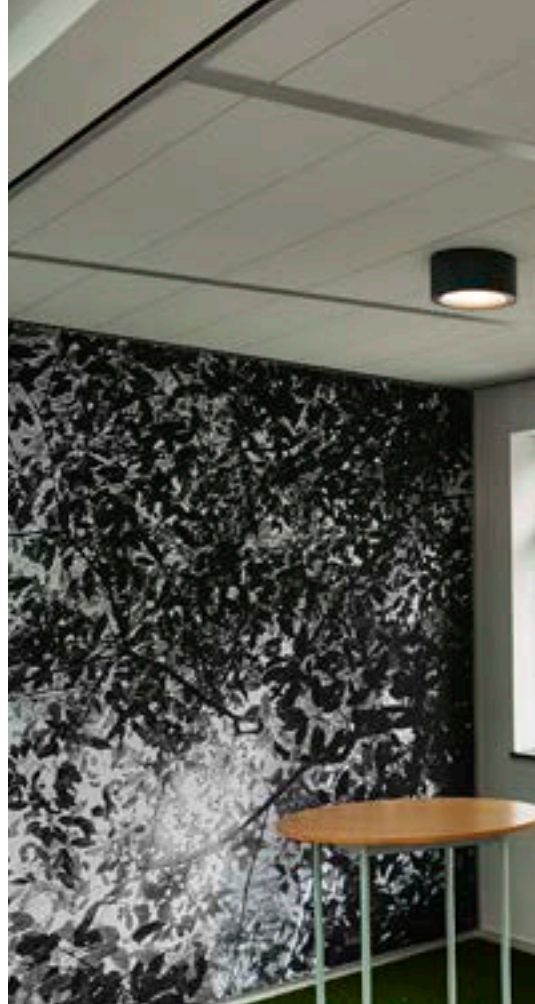





1001939 272

MARONA  
CL, PHASE

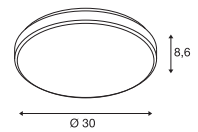

155156 273



200-240V ~50/60Hz | 430mA  
Potência total: 15W  
Material: polimetilacrilato (PMMA)/aço



Down 1200lm | 3000K

Variante	Art. n.º	EUR
● Cinzento	155156	115,00



1000785 274

PANEL 60  
CL, Redondo, PHASE

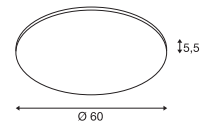

220-240V ~50/60Hz | 1000mA  
Potência total: 42W  
Material: alumínio/polimetilacrilato (PMMA)



Down 3150lm | 3000K  
3350lm | 4000K

Variante	Art. n.º	EUR
○ Branco 3150lm   3000K	1000783	292,00
○ Branco 3350lm   4000K	1000784	292,00
● Cinzento 3150lm   3000K	1000785	292,00
● Cinzento 3350lm   4000K	1000786	292,00



**PANEL**  
CL, 1200x300mm, PHASE

**PANEL 60**  
CL, Redondo, DALI

**PANEL**  
CL, 1200x300mm, DALI

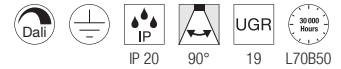
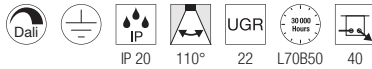
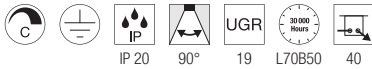
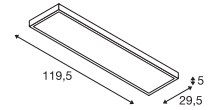
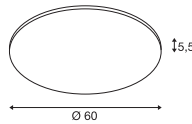
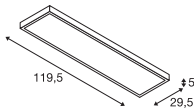

220-240V ~50/60Hz | 1000mA  
Potência total: 45W  
Material: alumínio/plástico

120-277V ~50/60Hz | 1000mA  
Potência total: 43W  
Material: alumínio/polimetilacrilato (PMMA)

120-277V ~50/60Hz | 1000mA  
Potência total: 43W  
Material: alumínio/polimetilacrilato (PMMA)



Down 3100lm | 3000K  
3400lm | 4000K

Down 3150lm | 3000K  
3350lm | 4000K

Down 3100lm | 3000K  
3400lm | 4000K

Variante	Art. n.º	EUR
○ Branco		
3100lm   3000K   IRC80	<b>1001505</b>	<b>278,00</b>
○ Branco		
3400lm   4000K   IRC80	<b>1001506</b>	<b>278,00</b>
● Cinzento		
3100lm   3000K   IRC80	<b>1001508</b>	<b>278,00</b>
● Cinzento		
3400lm   4000K   IRC90	<b>1001509</b>	<b>278,00</b>

Variante	Art. n.º	EUR
○ Branco		
3150lm   3000K	<b>1003040</b>	<b>302,00</b>
○ Branco		
3350lm   4000K	<b>1003041</b>	<b>302,00</b>
● Cinzento		
3150lm   3000K	<b>1003042</b>	<b>302,00</b>
● Cinzento		
3350lm   4000K	<b>1003043</b>	<b>302,00</b>

Variante	Art. n.º	EUR
○ Branco		
3100lm   3000K	<b>1003052</b>	<b>289,00</b>
○ Branco		
3400lm   4000K	<b>1003053</b>	<b>289,00</b>
● Cinzento		
3100lm   3000K	<b>1003054</b>	<b>289,00</b>
● Cinzento		
3400lm   4000K	<b>1003055</b>	<b>289,00</b>



Encontre a família  
NUMINOS® nas  
páginas 106–109



Encontre a família  
MEDO® nas  
páginas 166–167



NEW

Encontre a família  
LALU® nas  
páginas 176–185



Encontre a família  
ONE® nas  
páginas 186–191



SCKET

PANTILO  
ROPE 19 | 279



SCKET

PANTILO  
ROPE 20 | 279



SCKET

PANTILO  
ROPE 27 | 279



SCKET

PANTILO OVAL | 281



SCKET

PANTILO 20 | 281



SCKET

PANTILO 28 | 281



SCKET

PANTILO  
CONVEX 29 | 283



SCKET

PANTILO  
CONVEX 40 | 283



SCKET

ASTO TUBE | 285



SCKET

ASTO TUBE | 285



SCKET

ASTO TUBE | 285



SCKET

ASTO TUBE | 285



LED

WORKLIGHT  
PRO 120 | 287



LED

WORKLIGHT  
PRO 150 | 287



LED

WORKLIGHT | 288



LED

I-PENDANT PRO | 289



LED

PANEL 60 | 289



LED

NOYA | 290



LED

GLENOS® | 291



LED

GLENOS® | 291



LED

Q-LINE® | 293



LED

Q-LINE® | 293



LED

Q-LINE® | 293



LED

OCULUS | 294



SCKET

FITU | 295



SCKET

FENDA | 296



FENDA | 296



FENDA | 296



FENDA | 297



FENDA | 297



FENDA | 297



HELIA  
AMBIENT 35 | 300



HELIA  
AMBIENT 35 | 300



HELIA 30 | 301



HELIA 30 | 301



HELIA 40 | 303



HELIA 40 | 303



ASTINA | 305



ENOLA B | 305



ENOLA | 305



ANELA | 306



LISENNE | 306



TONGA® | 307



QUADRASS | 307



PARA CONE GL | 309



PARA CONE 20 | 309



PARA CONE 30 | 309



PHELIA 10 | 310



PHELIA 20 | 311



PHELIA 25 | 311



PHELIA 30 | 311



FORCHINI 50 | 312



FORCHINI 70 | 312



FORCHINI M 40 | 313



FORCHINI M 50 | 313



LIGHT EYE® 90 | 314



LIGHT EYE® 150 | 314



SUN / BIG SUN | 315



ROTOBALL 25 | 317



ROTOBALL 40 | 317



ROTOBALL 50 | 317



PARA DOME | 318



PARA DOME | 318



PARA DOME | 318



PARA 380 | 319



1007588 279

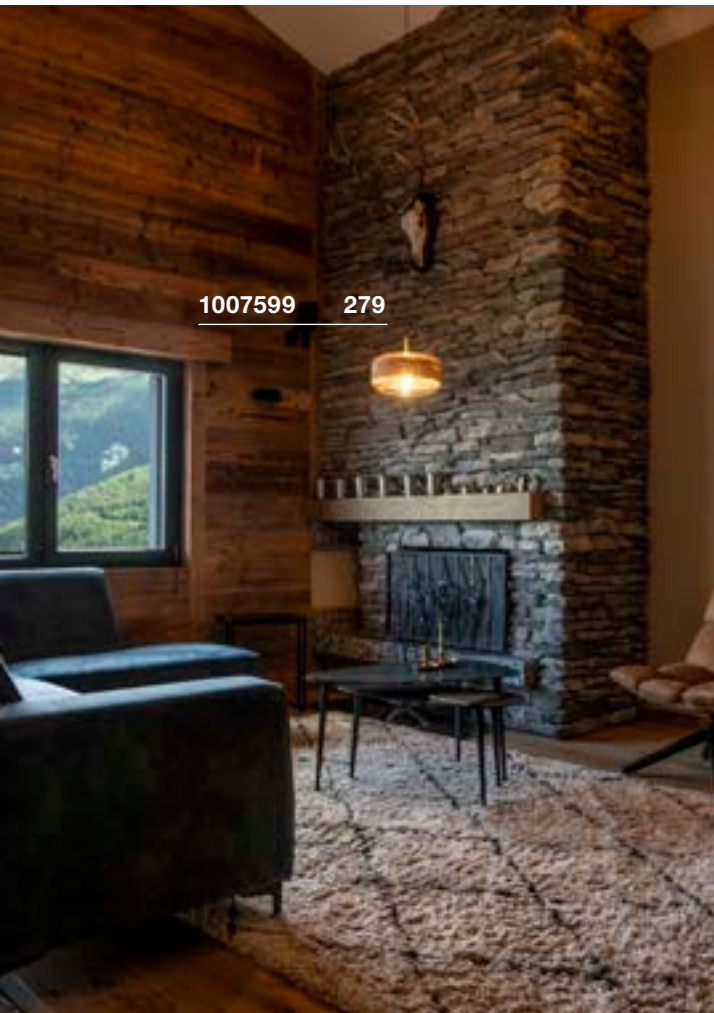

1007599 279



1007597 279



### PANTILO ROPE 19 PD, E27

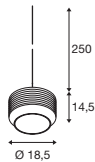

200-240V ~50/60Hz  
Material: vidro / aço / cânhamo

- Extremidade do cabo aberta



Casquilho: 1xE27 Máx. Ø: 10 cm C: 11 cm

Variante	Art. n.º	EUR
● Ambar / dourado	1007597	199,00
● Antracite / prata	1007596	199,00



A60 | 7,5W | 180°  
2700K | 720lm | EE=F  
8kWh/1000h



Art. N.º: 1005305 | 19,00 EUR



Artigo	Art. n.º	EUR
Adaptador de calha monofásica		
● Preto	143120	15,00
○ Branco	143121	15,00
● Cinzento	143124	15,00
Adaptador de calha trifásica		
● Preto	145990	19,70
● Cinzento	145994	19,70
○ Branco	1001542	19,70
FITU roseta saliente 1 saída		
● Preto	132600	26,00
○ Branco	132601	26,00
● Dourado	1002163	28,50
● Cromado	132605	28,50

### PANTILO ROPE 20 PD, E27

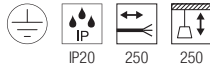
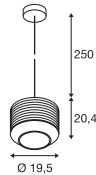

200-240V ~50/60Hz  
Material: vidro / aço / cânhamo



Casquilho: 1xE27 Máx. Ø: 10 cm C: 18 cm

Variante	Art. n.º	EUR
● Ambar / dourado	1007589	239,00
● Antracite / prata	1007588	239,00



A60 | 7,5W | 180°  
2700K | 720lm | EE=F  
8kWh/1000h



Art. N.º: 1005305 | 19,00 EUR

### PANTILO ROPE 27 PD, E27

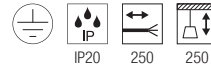
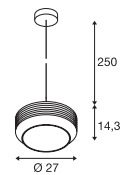

200-240V ~50/60Hz  
Material: vidro / aço / cânhamo



Casquilho: 1xE27 Máx. Ø: 15 cm C: 11 cm

Variante	Art. n.º	EUR
● Ambar / dourado	1007599	259,00
● Antracite / prata	1007598	259,00



A60 | 7,5W | 180°  
2700K | 720lm | EE=F  
8kWh/1000h



Art. N.º: 1005305 | 19,00 EUR

1006403 281







### PANTILO OVAL PD, E27

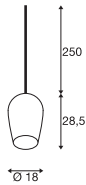

200-240V ~50/60Hz  
Material: vidro

- Extremidade do cabo aberta



Casquilho: 1xE27

Variante	Art. n.º	EUR
○ Branco	1006402	155,00
● Dourado	1006403	175,00
● Cromado	1006398	175,00
● Cobre	1006400	175,00



A60 | 7,5W | 180°  
2700K | 720lm | EE=F  
8kWh/1000h



Art. N.º: 1005305 | 19,00 EUR



Artigo	Art. n.º	EUR
Adaptador de calha monofásica		
● Preto	143120	15,00
○ Branco	143121	15,00
● Cinzento	143124	15,00
Adaptador de calha trifásica		
● Preto	145990	19,70
● Cinzento	145994	19,70
○ Branco	1001542	19,70
Roseta saliente para teto		
● Preto	1004744	34,00
○ Branco	1004745	34,00
● Cromado	1004746	37,25
Roseta FITU saliente redonda 1 saída		
○ Branco	132601	26,00
● Dourado	1002163	28,50
Roseta FITU saliente redonda 1 saída		
● Preto	132600	26,00
● Cromado	132605	28,50

### PANTILO 20 PD, E27

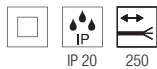
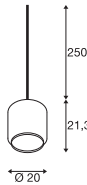

200-240V ~50/60Hz  
Material: vidro

- Extremidade do cabo aberta



Casquilho: 1xE27

Variante	Art. n.º	EUR
○ Branco	1006396	155,00
● Dourado	1006395	175,00
● Cromado	1003004	175,00
● Cobre	1003005	175,00



A60 | 7,5W | 180°  
2700K | 720lm | EE=F  
8kWh/1000h



Art. N.º: 1005305 | 19,00 EUR



Artigo	Art. n.º	EUR
Adaptador de calha monofásica		
● Preto	143120	15,00
○ Branco	143121	15,00
● Cinzento	143124	15,00
Adaptador de calha trifásica		
● Preto	145990	19,70
● Cinzento	145994	19,70
○ Branco	1001542	19,70
Roseta FITU saliente redonda 1 saída		
○ Branco	132601	26,00
● Dourado	1002163	28,50
Roseta FITU saliente redonda 1 saída		
● Preto	132600	26,00
● Cromado	132605	28,50

### PANTILO 28 PD, E27

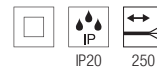
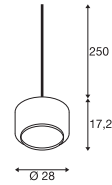

200-240V ~50/60Hz  
Material: vidro

- Extremidade do cabo aberta



Casquilho: 1xE27

Variante	Art. n.º	EUR
○ Branco	1006399	191,00
● Dourado	1006397	211,00
● Cromado	1003006	211,00
● Cobre	1003007	211,00



A60 | 7,5W | 180°  
2700K | 720lm | EE=F  
8kWh/1000h



Art. N.º: 1005305 | 19,00 EUR



Artigo	Art. n.º	EUR
Adaptador de calha monofásica		
● Preto	143120	15,00
○ Branco	143121	15,00
● Cinzento	143124	15,00
Adaptador de calha trifásica		
● Preto	145990	19,70
● Cinzento	145994	19,70
○ Branco	1001542	19,70
Roseta FITU saliente redonda 1 saída		
○ Branco	132601	26,00
● Dourado	1002163	28,50
Roseta FITU saliente redonda 1 saída		
● Preto	132600	26,00
● Cromado	132605	28,50



1003443 283



### PANTILHO CONVEX 29 PD, E27

### PANTILHO CONVEX 40 PD, E27

1003444 283

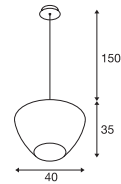
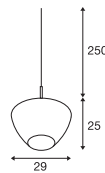

220-240V ~50/60Hz  
Material: vidro/aço

220-240V ~50/60Hz  
Material: vidro/aço

- Extremidade do cabo aberta

**SECKET INSIDE** 40 W

**SECKET INSIDE** 40 W

Casquilho: E27 Máx. Ø: 10 cm C: 20 cm

Casquilho: E27 Máx. Ø: 15 cm C: 30 cm

Variante	Art. n.º	EUR
● Cromado	1003443	247,00

Variante	Art. n.º	EUR
● Cromado	1003444	353,00



A60 | 7,5W | 180°  
2700K | 720lm | EE=F  
8kWh/1000h



Art. N.º: 1005305 | 19,00 EUR

A60 | 7,5W | 180°  
2700K | 720lm | EE=F  
8kWh/1000h



Art. N.º: 1005305 | 19,00 EUR



Artigo	Art. n.º	EUR
Adaptador de calha monofásica		
● Preto	143120	15,00
○ Branco	143121	15,00
● Cinzento	143124	15,00
Adaptador de calha trifásica		
● Preto	145990	19,70
● Cinzento	145994	19,70
○ Branco	1001542	19,70
Roseta FITU saliente redonda 1 saída		
○ Branco	132601	26,00
● Dourado	1002163	28,50
Roseta FITU saliente redonda 1 saída		
● Preto	132600	26,00
● Cromado	132605	28,50

1006438 285





## ASTO TUBE

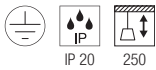

220-240V ~50/60Hz  
Material: alumínio



Casquilho: 1xGU10



LED GU10 51mm | 6W | 36°  
2200-2700K | 360lm | EE=G  
6kWh/1000h



Art. N.º: 1005273 | 9,99 EUR

## ASTO TUBE PD, single, GU 10

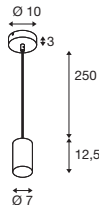

## ASTO TUBE PD, double, GU 10

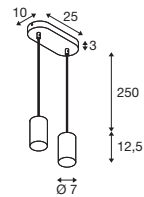

Variante	Art. n.º	EUR
● Preto	1006431	60,00
○ Branco	1006432	60,00

Variante	Art. n.º	EUR
● Preto	1006433	110,00
○ Branco	1006434	110,00

## ASTO TUBE Refletor decorativo



A: 3,95 cm  
Ø: 6,75 cm  
Material: policarbonato (PC)

## ASTO TUBE PD, triple, GU 10

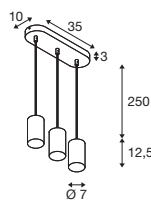

## ASTO TUBE PD, quadruple, GU 10

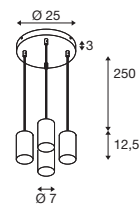

Variante	Art. n.º	EUR
● Cromado preto	1007190	4,00
● Dourado	1006450	4,00
● Cromado	1006449	4,00
● Cobre	1006451	4,00

Variante	Art. n.º	EUR
● Preto	1006435	160,00
○ Branco	1006436	160,00

Variante	Art. n.º	EUR
● Preto	1006437	195,00
○ Branco	1006438	195,00





## WORKLIGHT PRO 120 PD, DALI

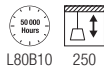
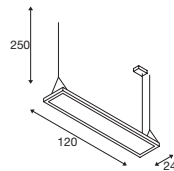

200-240V ~50/60Hz | 1200mA  
Potência total: 50W  
Material: alumínio/aço



Up 2800lm | 4000K  
Down 3300lm

Variante	Art. n.º	EUR
● Preto	1007468	499,00
○ Branco	1007469	499,00
● Cinzento	1007470	499,00

## WORKLIGHT PRO 150 PD, DALI

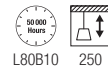
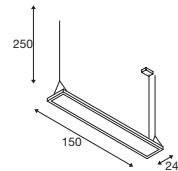

220-240V ~50/60Hz | 1400mA  
Potência total: 59W  
Material: alumínio/aço



Up 3300lm | 4000K  
Down 3900lm

Variante	Art. n.º	EUR
● Preto	1007471	599,00
○ Branco	1007472	599,00
● Cinzento	1007473	599,00

WORKLIGHT  
PD, DALI



NEW

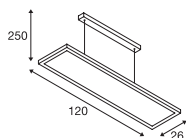

200-240V ~50/60Hz | 1550mA  
Potência total: 57W  
Material: alumínio



Up 2000lm | 4000K  
Down 3000lm

Variante	Art. n.º	EUR
● Preto	1005395	469,00
○ Branco	1005396	469,00
○ Prateado	1006345	469,00

1006345 288







I-PENDANT PRO  
PD, 1195x295mm, DALI

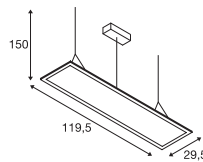
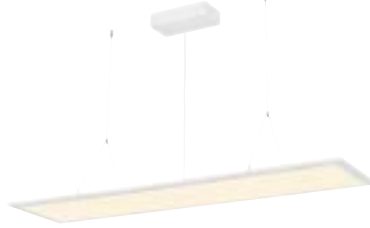

PANEL 60  
PD, Redondo, DALI

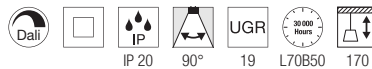
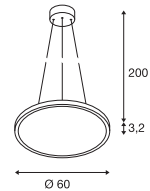

120-277V ~50/60Hz | 1000mA  
Potência total: 43W  
Material: alumínio/polimetilacrilato (PMMA)

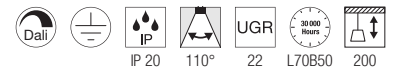

120-277V ~50/60Hz | 1000mA  
Potência total: 43W  
Material: alumínio/polimetilacrilato (PMMA)



Down 3750lm | 3000K  
3800lm | 4000K

Variante	Art. n.º	EUR
○ Branco 3750lm   3000K	1003048	373,00
○ Branco 3800lm   4000K	1003049	373,00
● Cinzento 3750lm   3000K	1003050	373,00
● Cinzento 3800lm   4000K	1003051	373,00



Down 3150lm | 3000K  
3350lm | 4000K

Variante	Art. n.º	EUR
○ Branco 3150lm   3000K	1003044	324,00
○ Branco 3350lm   4000K	1003045	324,00
● Cinzento 3150lm   3000K	1003046	324,00
● Cinzento 3350lm   4000K	1003047	324,00

NOYA  
PD, PHASE

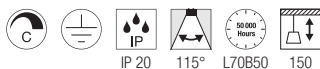
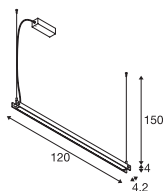

220-240V ~50/60Hz | 700mA  
Potência total: 32W  
Material: alumínio / policarbonato (PC)



Down 1861lm | 2700K | 2025lm | 3000K

Variante	Art. n.º	EUR
● Preto	1003530	479,00
○ Branco	1003532	479,00



1003530 290



1001403 291

**GLENOS®**  
PD, 1m, 1-10V

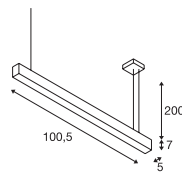

**GLENOS®**  
PD, 2m, 1-10V

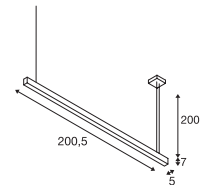

1001409 291

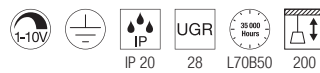

220-240V ~50/60Hz | 1000mA  
Potência total: 43W  
Material: alumínio/plástico



Down 2850lm | 3000K  
3300lm | 4000K

Variante	Art. n.º	EUR
● Preto 2850lm   3000K	<b>1001400</b>	<b>393,00</b>
● Preto 3300lm   4000K	<b>1001403</b>	<b>393,00</b>

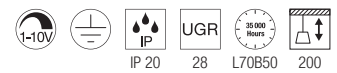

220-240V ~50/60Hz | 1000mA  
Potência total: 85W  
Material: alumínio/plástico



Down 5700lm | 3000K  
6600lm | 4000K

Variante	Art. n.º	EUR
● Preto 5700lm   3000K	<b>1001406</b>	<b>540,00</b>
● Preto 6600lm   4000K	<b>1001409</b>	<b>540,00</b>



1000933 293

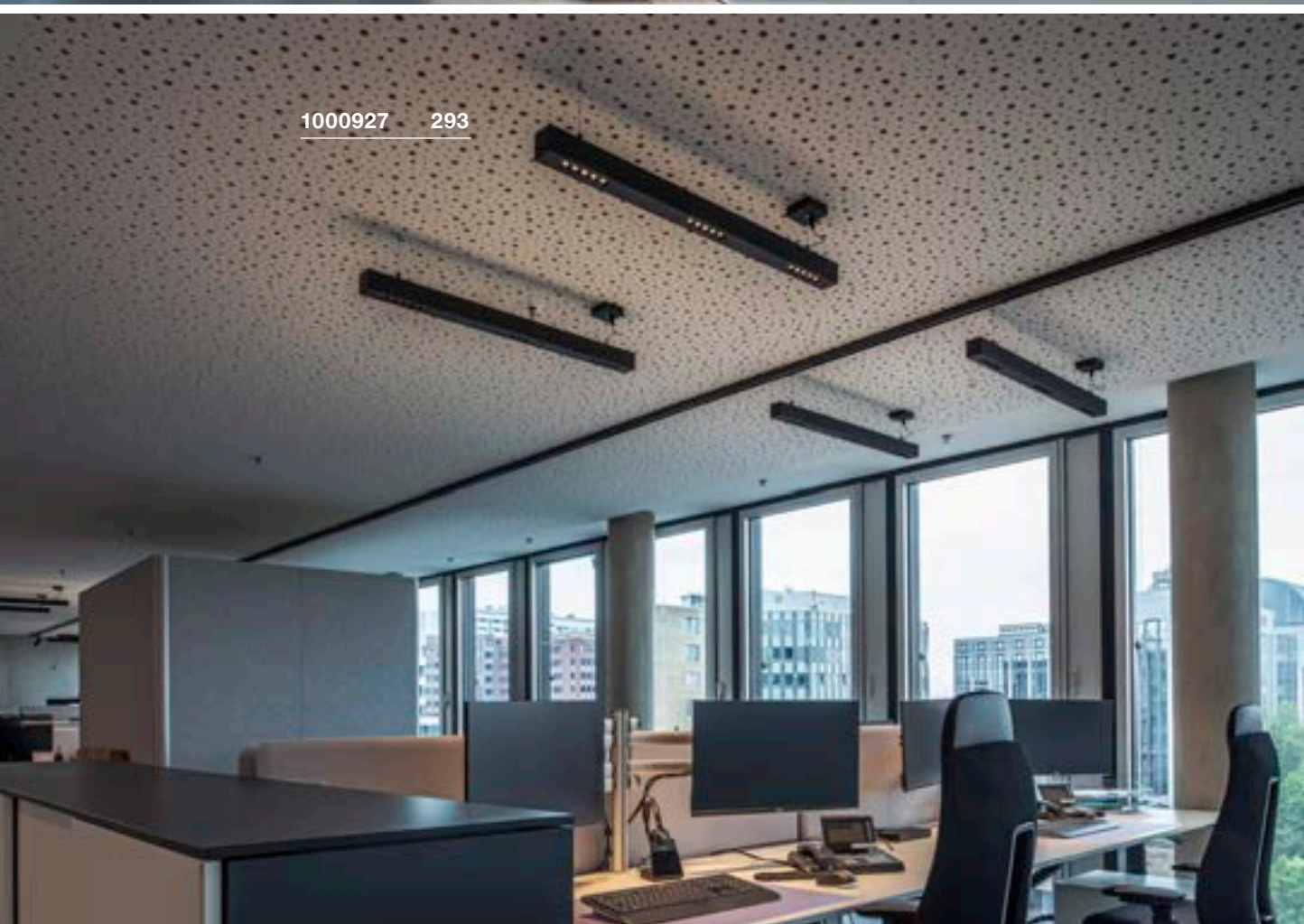

1000927 293



Q-LINE®  
PD, 1m, BAP, PHASE

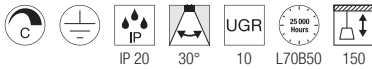
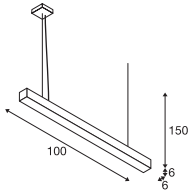

220-240V ~50/60Hz | 900mA  
Potência total: 46W  
Material: alumínio/plástico



Down 2100lm | 3000K  
2300lm | 4000K

Variante	Art. n.º	EUR
● Preto 2100lm   3000K	1000927	484,00
● Preto 2300lm   4000K	1000933	484,00
○ Branco 2100lm   3000K	1000926	484,00
○ Branco 2300lm   4000K	1000932	484,00

Q-LINE®  
PD, 2m, BAP, PHASE

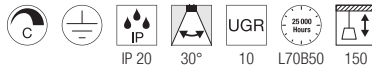
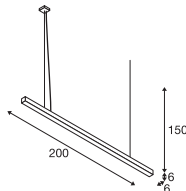

220-240V ~50/60Hz | 900mA  
Potência total: 93W  
Material: alumínio/plástico



Down 4200lm | 3000K  
4600lm | 4000K

Variante	Art. n.º	EUR
● Preto 4200lm   3000K	1000930	726,00
● Preto 4600lm   4000K	1000936	726,00
○ Branco 4200lm   3000K	1000929	726,00
○ Branco 4600lm   4000K	1000935	726,00

Q-LINE®  
PD, DALI, single

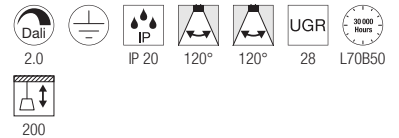
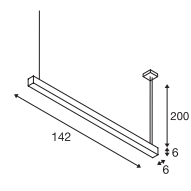

220-240V ~50/60Hz | 700mA  
Desempenho do sistema: 47W  
Material: alumínio/acrílico



Down 3700lm | 3000K

Variante	Art. n.º	EUR
● Preto	1001309	580,00
○ Branco	1001310	580,00

OCULUS  
PD, single, PHASE

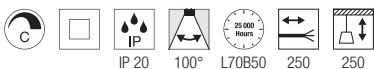
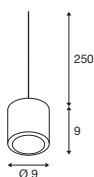

220-240V ~50/60Hz | 250mA

Potência total: 11W

Material: alumínio/vidro

- Inclui difusor fosco adicional
- Encontra os acessórios correspondentes na página 295
- Extremidade do cabo aberta



Down 36lm | 2000K - 780lm | 3000K

Variante	Art. n.º	EUR
● Preto	1004672	209,00
○ Branco	1004673	209,00

1004672 294



132690 295





**FITU**  
PD, E27

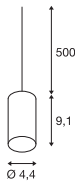

220-240V ~50/60Hz  
Material: alumínio

- Cabo em tecido
- Encontra os acessórios correspondentes na página 295
- Extremidade do cabo aberta



Casquilho: 1xE27

Variante	Art. n.º	EUR
● Preto	132690	60,00
○ Branco	132691	60,00



A60 | 7,5W | 320°  
2700K | 800lm | EE=F  
8kWh/1000h



Art. N.º: 1005303 | 9,60 EUR

**Roseta FITU saliente redonda 1 saída**

16A máx.  
Aço  
A: 3,9 cm  
Ø: 8,5 cm  
Incl. alívio de tensão



Variante	Art. n.º	EUR
● Preto	132600	26,00
○ Branco	132601	26,00
● Dourado	1002163	28,50
● Cromado	132605	28,50

**Roseta FITU saliente redonda 3 saídas**

16A máx.  
Aço  
A: 5,4 cm  
Ø: 22 cm  
Incl. alívio de tensão



Variante	Art. n.º	EUR
● Preto	132610	63,00
○ Branco	132611	63,00

**Roseta saliente para teto**

16A máx.  
Aço  
A: 2,6 cm  
Ø: 9 cm



Variante	Art. n.º	EUR
● Preto	1004744	34,00
○ Branco	1004745	34,00
● Dourado	1006377	37,25
● Cromado	1004746	37,25

**Roseta para encastrar no teto**

16A máx.  
Aço/Poliamida 66 (PA 66)  
A: 3,3 cm  
Ø: 8,5 cm



Variante	Art. n.º	EUR
● Preto	1004674	22,50
○ Branco	1004675	22,50
● Dourado	1006378	27,00
● Cromado	1004676	27,00

**Gancho para teto**

Alumínio  
C: 4,6 cm  
Ø: 1,8 cm



Variante	Art. n.º	EUR
● Preto	132670	19,20
○ Branco	132671	19,20

**Adaptador de calha monofásica**

6 A máx.  
Policarbonato (PC)  
C: 8,5 cm L: 3,5 cm A: 3,2 cm  
Carga mec. máx. 2 kg



Variante	Art. n.º	EUR
● Preto	143120	15,00
○ Branco	143121	15,00
● Cinzento	143124	15,00

**Adaptador de calha trifásica**

10 A máx.  
Plástico  
C: 9,6 cm L: 3,5 cm A: 4,5 cm  
Carga máxima 5 kg



Variante	Art. n.º	EUR
● Preto	145990	19,70
○ Branco	1001542	19,70
● Cinzento	145994	19,70

**Gancho de cabo**

Alumínio  
C: 3,1 cm  
Ø: 1,4 cm



Variante	Art. n.º	EUR
● Preto	132680	12,50
○ Branco	132681	12,50

FENDA  
PD, E27

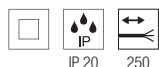
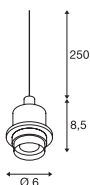

220-240V ~50/60Hz  
Material: aço/plástico

- Encontra os acessórios correspondentes na página 295
- Extremidade do cabo aberta



Casquilho: 1xE27

Variante	Art. n.º	EUR
● Preto	132660	29,25
○ Branco	132661	29,25
● Cromado	132662	33,00



A60 | 7,5W | 320°  
2700K | 800lm | EE=F  
8kWh/1000h



Art. N.º: 1005303 | 9,60 EUR

FENDA  
Difusor em vidro



A: 20 cm  
Ø: 12,5 cm  
Material: vidro

FENDA  
15 cm, Redondo



A: 40 cm  
Ø: 15 cm  
Material: têxtil/aço

Variante	Art. n.º	EUR
● Castanho	1000773	65,00

Variante	Art. n.º	EUR
● Preto	156152	53,00
○ Branco	156141	44,75
● Cinzento	1004773	44,75
● Bege	156143	44,75

155560 + 1000773 296







FENDA  
30 cm, redondo



A: 20 cm  
Ø: 30 cm  
Material: têxtil/aço

FENDA  
Ø 45 cm, redondo



A: 28 cm  
Ø: 45,5 cm  
Material: têxtil/aço

FENDA  
Ø 70 cm, redondo



A: 36 cm  
Ø: 70 cm  
Material: têxtil/aço

• Não é adequado para Fenda Bow.

Variante	Art. n.º	EUR
● Preto/cobre	155592	70,00
○ Branco	155582	53,00
● Cinzento	1004774	53,00
● Bege	155583	53,00

Variante	Art. n.º	EUR
● Preto/cobre	156122	88,00
○ Branco	156111	83,00
● Cinzento	1004775	83,00
● Bege	156113	83,00

Variante	Art. n.º	EUR
● Preto/cobre	1000580	129,00
○ Branco	1000579	112,00



Artigo	Art. n.º	EUR
Difusor em vidro acrílico	156100	44,50



Artigo	Art. n.º	EUR
Difusor em vidro acrílico	1000957	94,00

155561 + 1000579 296 + 297



# MIX & MATCH FENDA

## FENDA Ø15

Preto	156152
Branco	156141
Bege	156143
Cinzeno	1004773



## FENDA Ø30

Preto	155592
Branco	155582
Bege	155583
Cinzeno	1004774



## FENDA Ø45

Preto	156122
Branco	156111
Bege	156113
Cinzeno	1004775

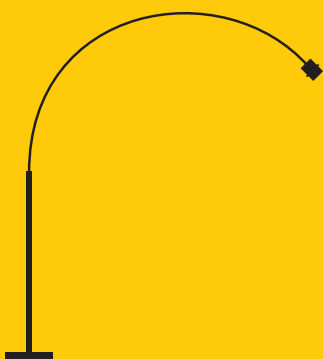

### FENDA BOW

Preto	1003029
Cromado	1000763



### FENDA TL

Preto	155780
-------	--------



### FENDA FL

Preto	155790
-------	--------



### FENDA TL

Preto	155540
-------	--------



### FENDA FL

Preto	155490
-------	--------

Combine os produtos SLV Mix & Match totalmente de acordo com o seu gosto. Perfeitamente compatíveis entre si, encontra artigos a combinar não só na família FENDA mas também entre as famílias de produtos FENDA e FITU. Identifica os produtos SLV Mix & Match pelo seguinte símbolo :



**MIX**  
match

## FENDA Ø70

Preto | 1000580  
Branco | 1000579

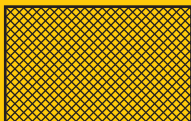

## FENDA Ø12,5

*Glass Shade*

Castanho | 1000773



## FENDA PD

Preto | 132660  
Branco | 132661  
Cromado | 132662

## FENDA CL

Preto | 155550  
Branco | 155551

## FITU CRANE BASE

Preto | 1004682



## FITU PD

Preto | 132690  
Branco | 132691

## HELIA AMBIENT 35 PD, PHASE

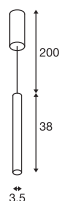
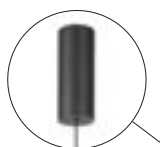

L70B50 200

220-240V ~50/60Hz | 500mA  
Potência total: 9W  
Material: alumínio/acrílico



Down 425lm | 3000K

Variante	Art. n.º	EUR
● Preto	1003436	219,00

## HELIA AMBIENT 35 PD

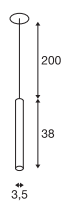
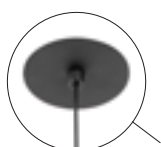

3 cm



L70B50 200

500mA  
Potência total: 7,5W  
Material: alumínio/acrílico

- Extremidade do cabo aberta
- Ø da roseta para encastrar 68 mm



Down 425lm | 3000K

Variante	Art. n.º	EUR
● Preto	1003435	179,00



Artigo	Art. n.º	EUR
Driver 20W   350mA/500mA   regulação fase		
○ Branco	1007227	40,00
Driver 25W   150-700mA   DALI		
○ Branco	1007229	70,00
Driver 21W   500mA incl. alívio de tensão		
○ Branco	1007226	30,00

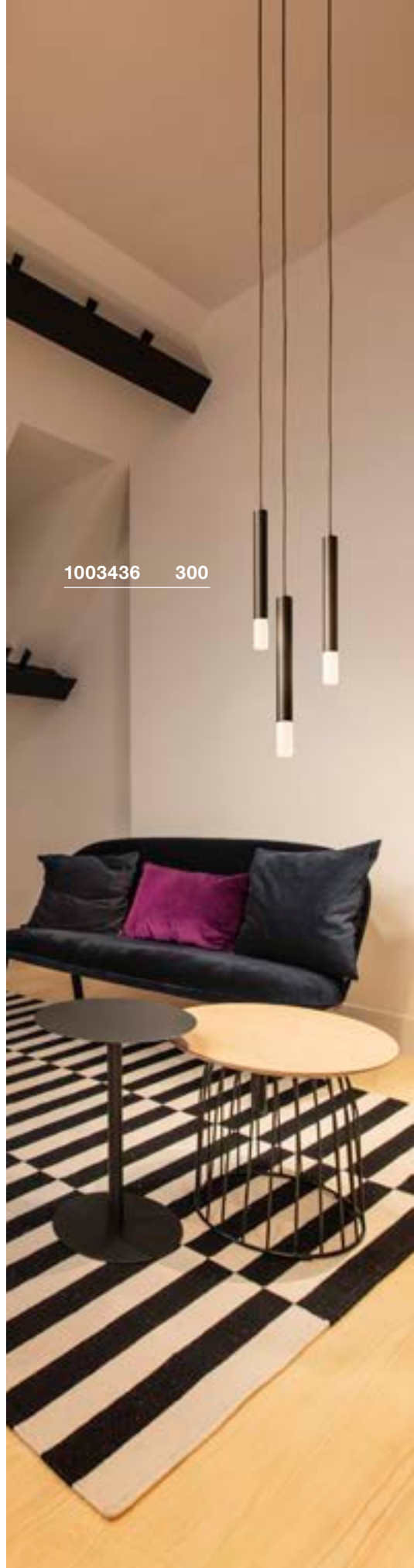

1003436 300



## HELIA 30 PD, PHASE

## HELIA 30 PD

152360 301

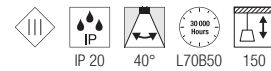
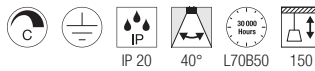
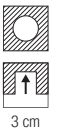
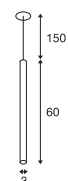
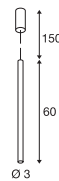

220-240V ~50/60Hz | 500mA  
Potência total: 9,2W  
Material: alumínio

500mA  
Potência total: 7,5W  
Material: alumínio

- Inclui roseta para encastrar
- Espessura do teto falso: máx. 12 mm
- Ø da roseta para encastrar 68 mm



Down 590lm | 3000K



Down 500lm | 3000K

Variante	Art. n.º	EUR
● Preto	152360	219,00

Variante	Art. n.º	EUR
● Preto	158400	179,00



Artigo	Art. n.º	EUR
--------	----------	-----

Driver 20W | 350mA/500mA | regulação fase  
○ Branco 1007227 ● 40,00

Driver 25W | 150-700mA | DALI

○ Branco 1007229 ● 70,00

Driver 21W | 500mA incl. alívio de tensão  
○ Branco 1007226 ● 30,00

152370 303





## HELIA 40 PD, PHASE

## HELIA 40 PD

158400 303

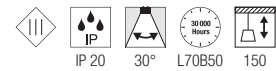
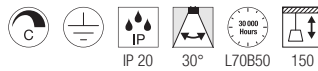
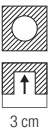
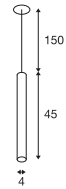
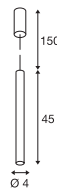

220-240V ~50/60Hz | 500mA  
Potência total: 10W  
Material: alumínio

500mA  
Potência total: 9W  
Material: alumínio

- Inclui roseta para encastrar
- Espessura do teto falso: máx. 12 mm
- Ø da roseta para encastrar 68 mm



Down 730lm | 3000K



Down 700lm | 3000K

Variante	Art. n.º	EUR
● Preto	152370	249,00

Variante	Art. n.º	EUR
● Preto	158410	199,00



Artigo	Art. n.º	EUR
Driver 20W   350mA/500mA   regulação fase		
○ Branco	1007227	40,00
Driver 25W   150-700mA   DALI		
○ Branco	1007229	70,00
Driver 21W   500mA incl. alívio de tensão		
○ Branco	1007226	30,00



149388

305





### ASTINA PD, QPAR51

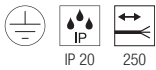
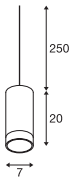

220-240V ~50/60Hz  
Material: alumínio

- Extremidade do cabo aberta



Casquilho: 1xGU10

Variante	Art. n.º	EUR
● Preto	1002939	117,00
○ Branco	1002937	117,00



LED GU10 51mm | 6W | 36°  
2200-2700K | 360lm | EE=G  
6kWh/1000h



Art. N.º: 1005273 | 9,99 EUR

### ENOLA B PD, QPAR51

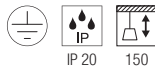
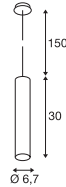

220-240V ~50/60Hz  
Material: alumínio/aço



Casquilho: 1xGU10

Variante	Art. n.º	EUR
● Preto	151850	110,00
○ Branco	151851	110,00
● Dourado	151853	115,00



LED GU10 51mm | 6W | 38°  
2700K | 450lm | EE=F  
6kWh/1000h



Art. N.º: 1005077 | 7,50 EUR

### ENOLA PD, E27

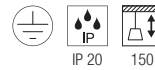
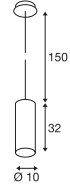
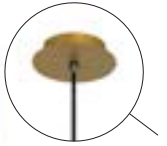

220-240V ~50/60Hz  
Material: alumínio/aço



Casquilho: 1xE27

Máx. Ø: 9 cm

C: 18 cm

Variante	Art. n.º	EUR
● Preto	149388	81,00
○ Branco	149381	81,00
● Dourado	149387	94,00



LED E27 | 13,2W | 220°  
2700K | 1300lm | EE=F  
13kWh/1000h



Art. N.º: 1005302 | 12,25 EUR



Artigo	Art. n.º	EUR
Adaptador de calha monofásica		
● Preto	143120	15,00
○ Branco	143121	15,00
● Cinzento	143124	15,00
Adaptador de calha trifásica		
● Preto	145990	19,70
● Cinzento	145994	19,70
○ Branco	1001542	19,70
Roseta FITU saliente para teto 1 saída		
● Preto	132600	26,00
● Cromado	132605	28,50
Roseta FITU saliente para teto 1 saída		
○ Branco	132601	26,00
Roseta FITU saliente para teto 3 saídas		
● Preto	132610	63,00
○ Branco	132611	63,00

ANELA  
PD, PHASE



LISENNE  
PD, E27

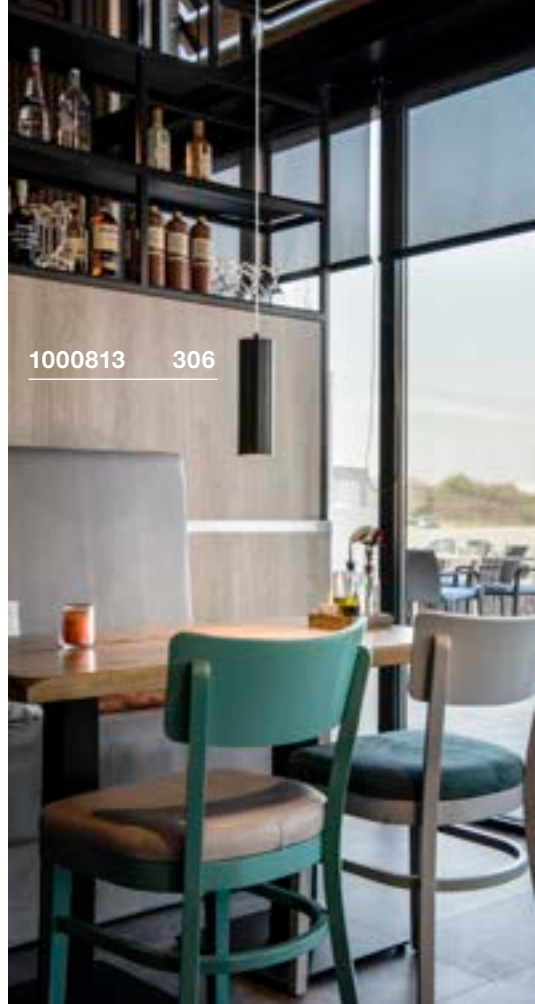

1000813 306

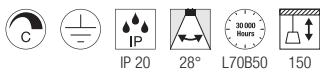

220-240V ~50/60Hz | 500mA  
Potência total: 10W  
Material: alumínio

- Sem refletor
- Fluxo luminoso com refletor 1000809 = 500 lm;  
Fluxo luminoso com refletor 1000810 = 620 lm;  
Fluxo luminoso com refletor 1000811 = 200 lm;  
Fluxo luminoso com refletor 1000812 = 600 lm



Down 220lm | 3000K 750lm |

Variante	Art. n.º	EUR
● Preto	1000813	189,00



Artigo	Art. n.º	EUR
Refletor 28°		
● Preto	1000811	19,75
○ Branco	1000812	19,75
● Dourado	1000809	19,75
● Cinzento	1000810	19,75

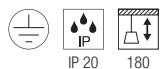

220-240V ~50/60Hz  
Material: basalto/vidro



Casquilho: 1xE27 Máx. Ø: 5,9 cm C: 15 cm

Variante	Art. n.º	EUR
● Cinzento/Cast.	155714	241,00



LED E27 | 8W | 240°  
3000K | 880lm | EE=E  
8kWh/1000h

Art. N.º: 1005289 | 10,25 EUR



155714 306



133444 307

### TONGA® PD, E14

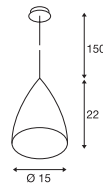

220-240V ~50/60Hz  
Material: alumínio/vidro



Casquilho: 1xE14 Máx. Ø: 5,1 cm C: 13 cm

Variante	Art. n.º	EUR
● Cinzento	133444	129,00



C35 | 4,2W | 320°  
2700K | 350lm | EE=G  
5kWh/1000h



Art. N.º: 1005285 | 8,50 EUR

### QUADRASS PD, E27

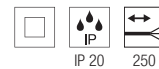
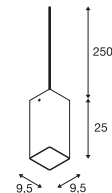

220-240V ~50/60Hz  
Material: aço/vidro



Casquilho: 1xE27 Máx. Ø: 6,5 cm C: 18 cm

Variante	Art. n.º	EUR
● Cromado	1003432	104,00



LED E27 | 13,2W | 220°  
2700K | 1300lm | EE=F  
13kWh/1000h



Art. N.º: 1005302 | 12,25 EUR



Artigo	Art. n.º	EUR
Adaptador de calha monofásico		
○ Branco	143121	15,00
Adaptador de calha trifásico		
○ Branco	1001542	19,70
Roseta Fitu saliente para teto 1 saída		
○ Branco	132601	26,00

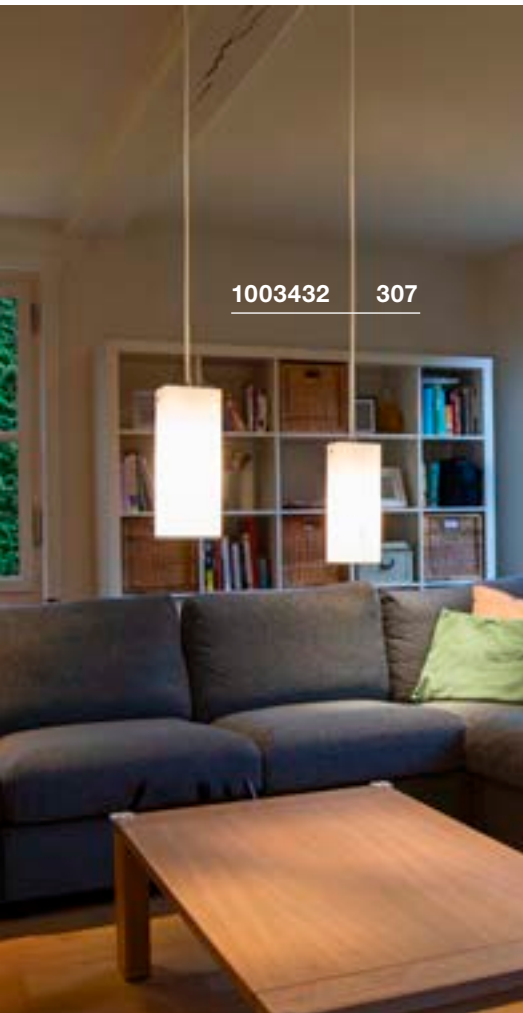

1003432 307



1006159 309



133019 309

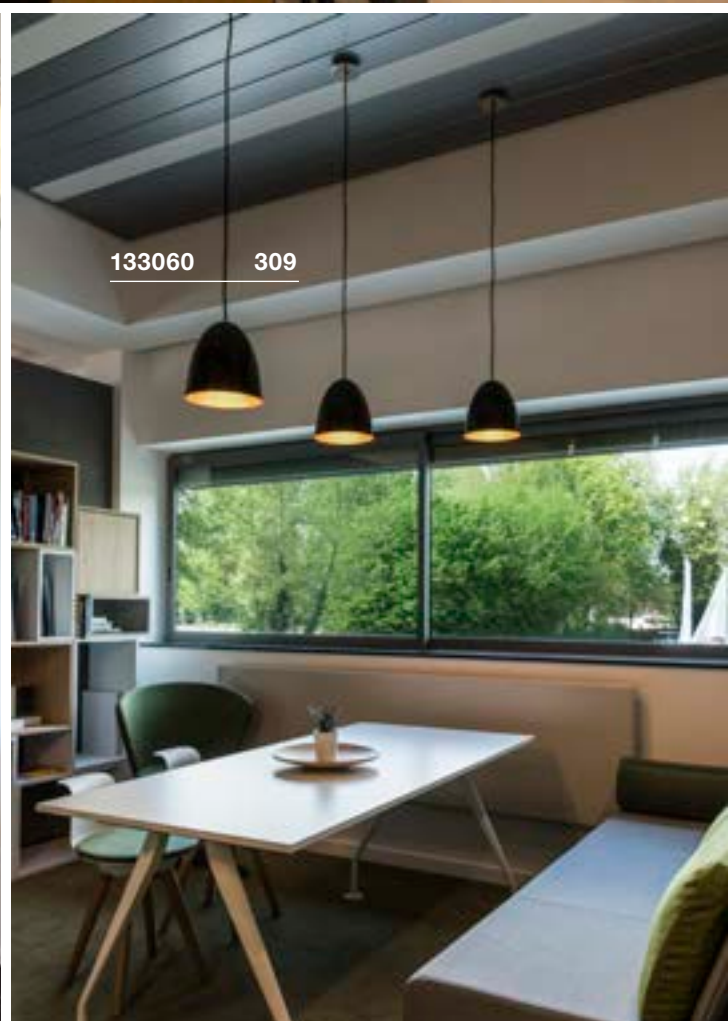

133060 309



### PARA CONE GL PD, GU10

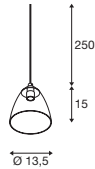

220-240V ~50/60Hz  
Material: alumínio/vidro

- Extremidade do cabo aberta



Casquilho: 1xGU10

Variante	Art. n.º	EUR
● Preto	1006159	84,00
○ Branco	1006160	84,00



LED GU10 51mm | 6W | 38°  
2700K | 450lm | EE=F  
6kWh/1000h



Art. N.º: 1005077 | 7,50 EUR

### PARA CONE 20 PD, E27

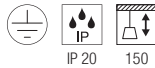
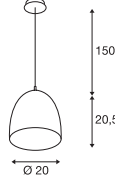

220-240V ~50/60Hz  
Material: alumínio/aço

- Cabo em tecido
- Versão preto/dourado com refletor dourado
- Todas as outras versões com refletor branco



Casquilho: 1xE27

Variante	Art. n.º	EUR
● Dourado/Preto	133050	117,00
● Cobre	133009	164,00



A60 | 7,5W | 320°  
2700K | 800lm | EE=F  
8kWh/1000h



Art. N.º: 1005303 | 9,60 EUR

### PARA CONE 30 PD, E27

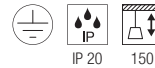
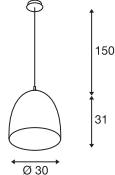

220-240V ~50/60Hz  
Material: alumínio/aço

- Cabo em tecido
- Versão preto/dourado com refletor dourado
- Todas as outras versões com refletor branco



Casquilho: 1xE27

Variante	Art. n.º	EUR
● Preto/dourado	133060	198,00
● Cobre	133019	222,00



A60 | 7,5W | 320°  
2700K | 800lm | EE=F  
8kWh/1000h



Art. N.º: 1005303 | 9,60 EUR



Artigo	Art. n.º	EUR
Adaptador de calha monofásica		
● Preto	143120	15,00
○ Branco	143121	15,00
● Cinzento	143124	15,00
Adaptador de calha trifásica		
● Preto	145990	19,70
● Cinzento	145994	19,70
○ Branco	1001542	19,70
Roseta saliente para teto		
● Preto	1004744	34,00
○ Branco	1004745	34,00
● Cromado	1004746	37,25
Roseta para encastrar no teto		
● Preto	1004674	22,50
○ Branco	1004675	22,50
Roseta FITU para teto 1 saída		
● Preto	132600	26,00
● Cromado	132605	28,50
Roseta FITU para teto 1 saída		
○ Branco	132601	26,00



1002949 311

1002951 310

1002950 311



1002949 311

## PHELIA 10 PD, E27

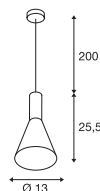

220-240V ~50/60Hz  
Material: alumínio

- Cabo em tecido

**SOCKET  
INSIDE** <23  
W

Casquilho: 1xE27

Variante	Art. n.º	EUR
● Preto/dourado	1002951	131,00



A60 | 7,5W | 180°  
2700K | 720lm | EE=F  
8kWh/1000h



Art. N.º: 1005305 | 19,00 EUR



PHELIA 20  
PD, E27

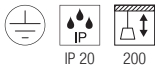

220-240V ~50/60Hz  
Material: alumínio

- Cabo em tecido



Casquilho: 1xE27

Variante	Art. n.º	EUR
● Preto/dourado	1002948	141,00



LED E27 | 13,2W | 220°  
2700K | 1300lm | EE=F  
13kWh/1000h



Art. N.º: 1005302 | 12,25 EUR

PHELIA 25  
PD, E27

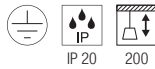

220-240V ~50/60Hz  
Material: alumínio

- Cabo em tecido



Casquilho: 1xE27

Variante	Art. n.º	EUR
● Preto/dourado	1002949	161,00



LED E27 | 13,2W | 220°  
2700K | 1300lm | EE=F  
13kWh/1000h



Art. N.º: 1005302 | 12,25 EUR

PHELIA 30  
PD, E27

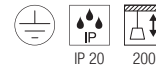
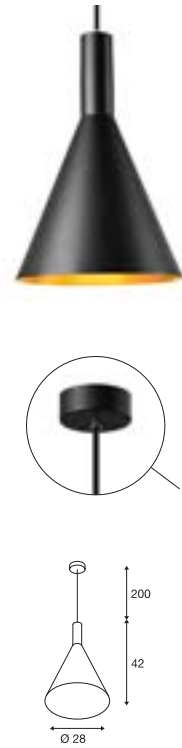

220-240V ~50/60Hz  
Material: alumínio

- Cabo em tecido



Casquilho: 1xE27

Variante	Art. n.º	EUR
● Preto/dourado	1002950	187,00



G125 | 7,5W | 320°  
2700K | 800lm | EE=F  
8kWh/1000h



Art. N.º: 1005310 | 18,50 EUR

FORCHINI 50  
PD, E27

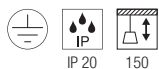
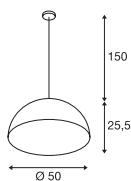

220-240V ~50/60Hz  
Material: GFK

- Cabo em tecido



Casquilho: 1xE27 Máx. C: 20 cm

Variante	Art. n.º	EUR
● Preto/dourado	155530	228,00



A60 | 7,5W | 180°  
2700K | 720lm | EE=F  
8kWh/1000h

Art. N.º: 1005305 | 19,00 EUR

FORCHINI 70  
PD, E27

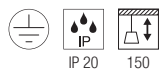
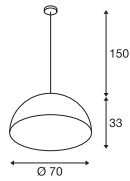

220-240V ~50/60Hz  
Material: GFK

- Cabo em tecido



Casquilho: 1xE27 Máx. C: 20 cm

Variante	Art. n.º	EUR
● Preto/dourado	1001701	403,00



LED E27 | 13,2W | 220°  
2700K | 1300lm | EE=F  
13kWh/1000h

Art. N.º: 1005302 | 12,25 EUR

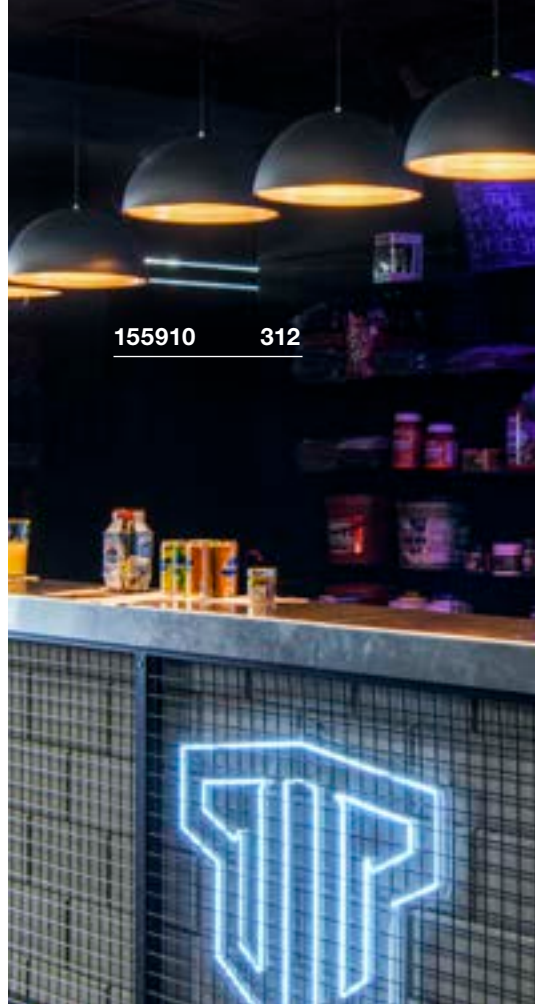

155910 312



1001701 311





FORCHINI M 40  
PD, E27

FORCHINI M 50  
PD, E27

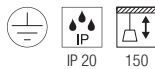
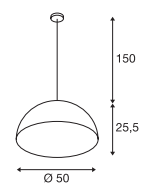
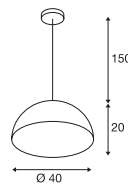

IP 20 150

220-240V ~50/60Hz  
Material: alumínio/aço

- Cabo em tecido



Casquilho: 1xE27

Máx. C: 15,2 cm

Variante	Art. n.º	EUR
● Preto/dourado	155910	228,00



A60 | 7,5W | 180°  
2700K | 720lm | EE=F  
8kWh/1000h



Art. N.º: 1005305 | 19,00 EUR

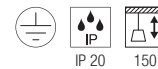

IP 20 150

220-240V ~50/60Hz  
Material: alumínio/aço

- Cabo em tecido



Casquilho: 1xE27

Máx. C: 18 cm

Variante	Art. n.º	EUR
● Preto/dourado	155930	251,00



LED E27 | 13,2W | 220°  
2700K | 1300lm | EE=F  
13kWh/1000h



Art. N.º: 1005302 | 12,25 EUR

LIGHT EYE® 90  
PD, GU10

LIGHT EYE® 150  
PD, QPAR111

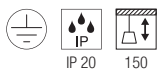
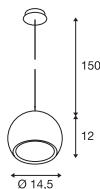
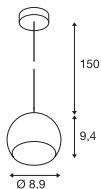

220-240V ~50/60Hz  
Material: aço

- Cabo em tecido



Casquilho: 1xGU10

Variante	Art. n.º	EUR
● Preto/cromado	133490	84,00



LED GU10 51mm | 5W | 38°  
2700-6500K | 350lm | EE=G  
5kWh/1000h



Art. N.º: 1005311 | 37,75 EUR



Artigo	Art. n.º	EUR
Lâmpada para anel decorativo Ø 5,7 cm		
● Preto	151040	5,30
○ Branco	151041	5,30
● Cromado	151049	7,75

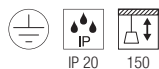

220-240V ~50/60Hz  
Material: aço

- Cabo em tecido



Casquilho: 1xGU10

Variante	Art. n.º	EUR
○ Branco/cromado	133481	119,00
● Cromado	133482	127,00
● Cobre	133489	155,00



QPAR111 | 12,5W | 30°  
2700K | 950lm | EE=F  
13kWh/1000h



Art. N.º: 1005276 | 49,50 EUR



133482 314



133481 314



SUN / BIG SUN  
PD, E27

1002045 315

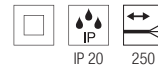
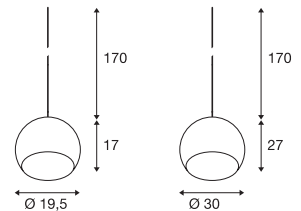

220-240V ~50/60Hz  
Material: aço/vidro

- Encontra os acessórios correspondentes na página 295
- Extremidade do cabo aberta

**SOCKET INSIDE** <60 W

Casquilho: 1xE27

Máx. Ø: 7 cm

C: 12 cm

Variante	Art. n.º	EUR
○ 1xE27   Ø: 19,5 cm	<b>1002045</b>	<b>91,00</b>
○ 1xE27   Ø: 30 cm	<b>1002046</b>	<b>171,00</b>



A60 | 7,5W | 320°  
2700K | 800lm | EE=F  
8kWh/1000h



Art. N.º: **1005303** | **9,60 EUR**

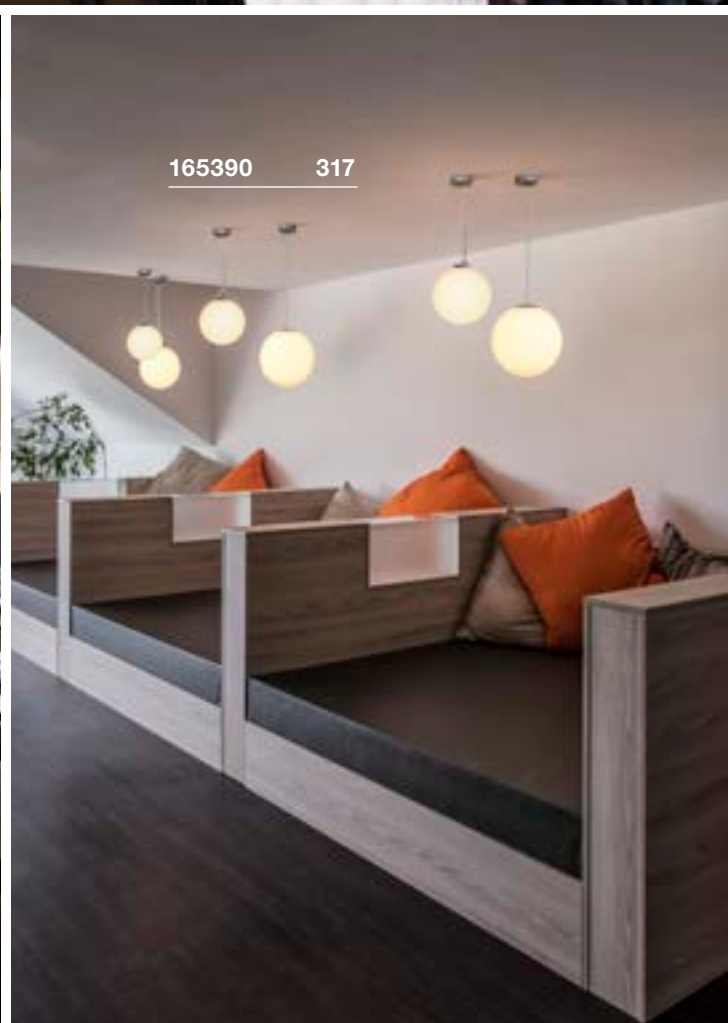



### ROTOBALL 25 PD, E27

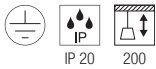

220-240V ~50/60Hz  
Material: aço/polietileno (PE)



Casquilho: 1xE27

Máx. Ø: 7 cm

Variante	Art. n.º	EUR
○ Branco	165390	161,00



LED E27 | 13,2W | 220°  
2700K | 1300lm | EE=F  
13kWh/1000h



Art. N.º: 1005302 | 12,25 EUR

### ROTOBALL 40 PD, E27

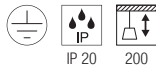

220-240V ~50/60Hz  
Material: aço/polietileno (PE)



Casquilho: 1xE27

Máx. Ø: 9,5 cm

Variante	Art. n.º	EUR
○ Branco	165410	181,00



LED E27 | 13,2W | 220°  
2700K | 1300lm | EE=F  
13kWh/1000h



Art. N.º: 1005302 | 12,25 EUR

### ROTOBALL 50 PD, E27

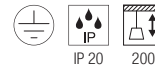
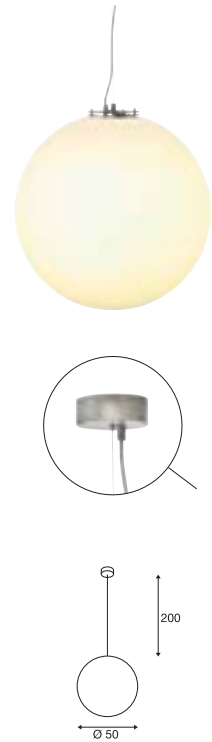

220-240V ~50/60Hz  
Material: aço/polietileno (PE)



Casquilho: 1xE27

Máx. Ø: 9,5 cm

Variante	Art. n.º	EUR
○ Branco	165400	222,00



LED E27 | 13,2W | 220°  
2700K | 1300lm | EE=F  
13kWh/1000h



Art. N.º: 1005302 | 12,25 EUR

## PARA DOME PD, E27

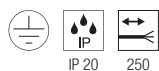
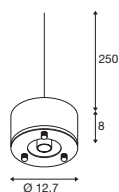

220-240V ~50/60Hz  
Material: alumínio

- Extremidade do cabo aberta



Casquilho: 1xE27 Máx. Ø: 7 cm

Variante	Art. n.º	EUR
● Preto	1005214	82,00
● Cinzento	1005215	82,00

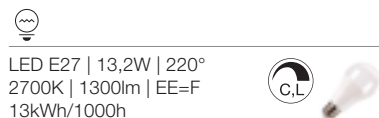

LED E27 | 13,2W | 220°  
2700K | 1300lm | EE=F  
13kWh/1000h

Art. N.º: 1005302 | 12,25 EUR

Artigo	Art. n.º	EUR
Adaptador de calha monofásica		
● Preto	143120	15,00
Adaptador de calha trifásica		
● Preto	145990	19,70
Roseta saliente para teto		
● Preto	1004744	34,00
Roseta quadrada saliente para teto		
● Preto	210060	32,00
Roseta FITU saliente 1 saída		
● Preto	132600	26,00

## PARA DOME Refletor



NEW



A: 20,6 cm  
Ø: 30,8 cm  
Material: alumínio

Variante	Art. n.º	EUR
● Preto	1005216	100,00
● Preto/dourado	1006410	100,00
● Cinzento	1005217	100,00

## PARA DOME Difusor



A: 20 cm  
Ø: 31,5 cm  
Material: policarbonato (PC)

Variante	Art. n.º	EUR
○ Transparente	1005218	100,00



165358 319



165359 319



PARA 380  
PD, E27



165359

319

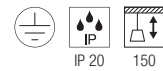
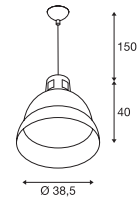

220-240V ~50/60Hz  
Material: alumínio

**SOCKET INSIDE** <20 W

Casquilho: 1xE27

Variante	Art. n.º	EUR
● Preto	165359	165,00
● Alumínio	165358	168,00



LED E27 | 13,2W | 220°  
2700K | 1300lm | EE=F  
13kWh/1000h



Art. N.º: 1005302 | 12,25 EUR

1007612 325







LED  
LYGANT | 325



LED  
LYGANT | 325



SOCKET  
VARYT | 327



LED  
SEDO 7 | 329



LED  
SEDO 14 | 329



LED  
SEDO 21 | 329



LED  
TRUKKO | 330



LED  
TRUKKO | 330



LED  
TRUKKO | 331



LED  
TRUKKO 80 | 331



LED  
TRUKKO 60 | 332



LED  
TRUKKO 90 | 332



LED  
MARYLIN 40 | 333



LED  
WL 149 | 334



SOCKET  
WL 149 | 334



SOCKET  
WL 106 | 335



SOCKET  
WL 106 | 335



SOCKET  
MIBO UP/DOWN | 337



LED  
MAGANDA | 337



LED  
DORISA 30 | 339



LED  
DORISA 50 | 339



LED  
GLENOS® 60 | 339



LED  
L-LINE 60 | 341



LED  
L-LINE 120 | 341



LED  
Q-LINE® | 341

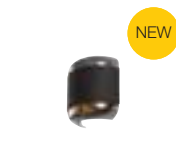

SOCKET  
PANTILO ROPE | 345

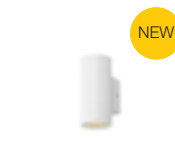

SOCKET  
ASTO TUBE | 347

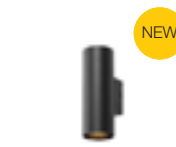

SOCKET  
ASTO TUBE | 347



LED  
MANA BASE | 349



LED  
MANA BASE | 349



LED  
MANA 40 | 319



LED  
MANA 60 | 349



LED  
MANA | 351



LED  
MANA | 351



LED  
MANA | 351



LED  
MANA | 353



LED  
MANA | 353



LED  
MANA | 353



LED  
MANA | 353



LED  
OCULUS | 355



LED  
OCULUS  
UP/DOWN | 355



SOCKET  
PLASTRA | 356



**SCKET**  
PLASTRA | 356



**SCKET**  
PLASTRA | 357



**SCKET**  
PLASTRA | 357



**SCKET**  
PLASTRA | 359



**LED**  
PLASTRA | 359



**LED**  
PLASTRA | 359



**SCKET**  
PLASTRA | 360



**SCKET**  
PLASTRA 101 | 361



**SCKET**  
PLASTRA | 361



**SCKET**  
PLASTRA 104 | 361



**LED**  
LOGS IN | 362



**LED**  
LOGS IN | 362



**LED**  
LOGS IN L | 363



**LED**  
LOGS IN L | 363



**LED**  
QUAD FRAME 14 | 364



**LED**  
QUAD FRAME 19 | 364



**LED**  
SHELL 15 | 365



**LED**  
SHELL 30 | 365



**LED**  
ASSO 300 | 366



**LED**  
ASSO 300 | 367



**SCKET**  
OSSA 180 | 367



**SCKET**  
OSSA 300 | 367



**LED**  
CARISO | 368



**LED**  
CARISO | 368



**LED**  
CHROMBO | 369



**LED**  
DIRETO 60 | 370



**LED**  
DIRETO 90 | 370



**LED**  
ARLINA 60 | 371



**LED**  
ARLINA 130 | 371



**SCKET**  
ANDREAS | 373



**SCKET**  
DENA 30 | 373



**SCKET**  
BASKET | 373



**SCKET**  
QUADRASS | 375



**LED**  
QUADRASS  
SPOT | 375



**SCKET**  
LISENNE | 375



**SCKET**  
FITU | 376



**SCKET**  
FITU CUBE | 376



**SCKET**  
THEO UP/DOWN | 377



**SCKET**  
SOLID CUBE | 377



**ENOLA B** | 379



**ENOLA B** | 379



**ASTINA  
UP/DOWN** | 379



**SCKET**

FENDA | 380



FENDA | 380



**LED**

KENKUA SPOT | 381



**LED**

COUPA FLEX | 381



**LED**

KARPO MAGN | 382



**LED**

KARPO GOOSE | 382



**LED**

KARPO 30 | 383



**LED**

KARPO | 383



**LED**

SOMNILA SPOT | 384



**LED**

SOMNILA SPOT | 385



**LED**

SOMNILA FLEX | 385



**LED**

SOMNILA FLEX | 385



**SCKET**

DIO FLEX PLATE | 387



**LED**

DIO FLEX PLATE | 387



**LED**

DIO FLEX PLATE | 387



**SCKET**

PHELIA | 388



**LED**

MERADO FLOOD | 388



**SCKET**

DISPLAY ADL 50 | 389

1007619 325





### LYGANT WL, single

### LYGANT WL, double

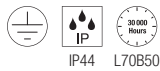
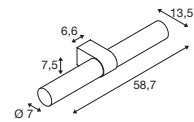
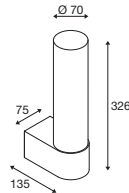

220-240V ~50/60Hz | 700mA  
Potência total: 8W  
Material: aço inoxidável/Vidro

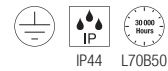

220-240V ~50/60Hz | 500mA  
Potência total: 11W  
Material: aço inoxidável/Vidro



Down 560lm | 3000K



Down 800lm | 3000K

Variante	Art. n.º	EUR
● Preto	1007614	249,00
○ Branco	1007613	249,00
● Bronze	1007612	279,00
● Cromado	1007615	279,00

Variante	Art. n.º	EUR
● Preto	1007618	359,00
○ Branco	1007617	359,00
● Bronze	1007616	385,00
● Cromado	1007619	385,00

1007603 327





VARYT  
WL, E14

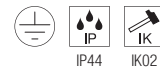
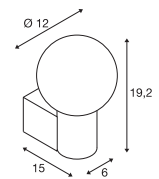

220-240V ~50/60Hz  
Material: aço inoxidável/Vidro 1007601  
Aço/Vidro 1007603, 1007602, 1007600

**SOCKET**  
**INSIDE** <6 W

Casquilho: 1xE14 máx. Ø: 3,8 cm C: 11 cm

Variante	Art. n.º	EUR
● Preto	1007603	145,00
○ Branco	1007602	145,00
● Bronze	1007601	179,00
● Cromado	1007600	159,00



C35 | 4,2W | 320°  
2700K | 350lm | EE=G  
5kWh/1000h



Art. N.º: 1005285 | 8,50 EUR

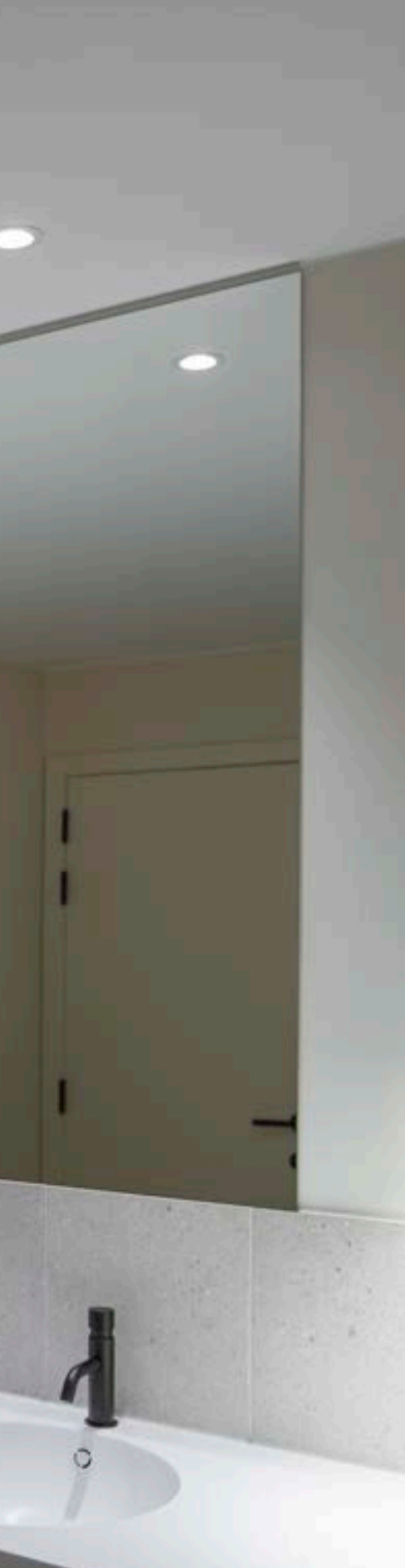



151796 329



1002964 329





SEDO 7  
WL

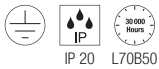
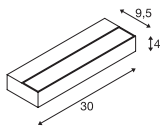

220-240V ~50/60Hz | 350mA  
Potência total: 11,5W  
Material: alumínio/vidro



Down 1020lm | 3000K

Variante	Art. n.º	EUR
○ Branco	1002962	187,00
● Alumínio	1002964	201,00

SEDO 14  
WL

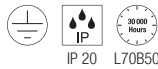
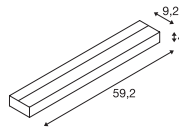

220-240V ~50/60Hz | 500mA  
Potência total: 18W  
Material: alumínio/vidro



Down 1300lm | 3000K

Variante	Art. n.º	EUR
○ Branco	151781	242,00
● Alumínio	151786	252,00

SEDO 21  
WL

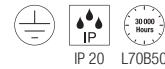
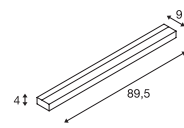

220-240V ~50/60Hz | 700mA  
Potência total: 30W  
Material: alumínio/vidro



Down 2500lm | 3000K

Variante	Art. n.º	EUR
○ Branco	151791	292,00
● Alumínio	151796	302,00



1004729 330

TRUKKO  
WL, quadrado, espelho aquecido

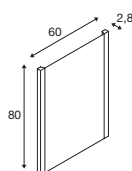
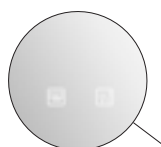

TRUKKO  
WL, retangular

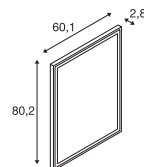
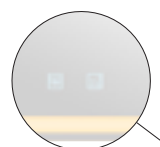

1004730 330



220-240V ~50/60Hz | 24V  
Potência total: 24W  
Material: vidro/alumínio

- Inclui aquecimento do espelho
- Temperatura de cor da luz regulável através de função touch



1310lm | 3000K | 1320lm | 4000K | 1340lm | 6500K

Variante	Art. n.º	EUR
☉ Prateado/leitoso	1004729	424,00



220-240V ~50/60Hz | 24V  
Potência total: 25W  
Material: vidro/plástico

- Inclui aquecimento do espelho
- Temperatura de cor da luz regulável através de função touch



1080lm | 3000K | 1290lm | 4000K | 1250lm | 6500K

Variante	Art. n.º	EUR
☉ Prateado/leitoso	1004730	383,00



1007201 331



TRUKKO  
WL, Redondo

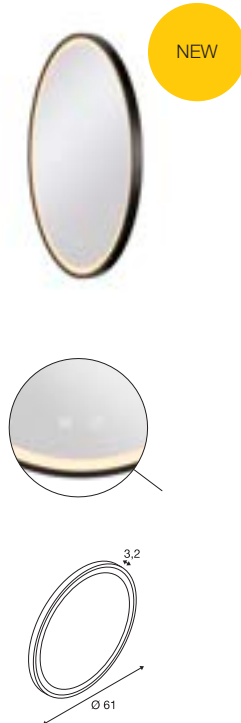

TRUKKO 80  
WL, Redondo



1007202 331



220-240V ~50/60Hz | 24V  
Potência total: 25W  
Material: vidro/ABS

- Inclui aquecimento do espelho
- Temperatura de cor da luz regulável através de função touch



730lm | 3000K | 710lm | 4000K | 720lm | 6500K

Variante	Art. n.º	EUR
○ Prateado/leitoso 1270/1260/1260lm	1004731	399,00
● Transparente / Preto 730/710/720lm	1007201	399,00



220-240V ~50/60Hz | 24V  
Potência total: 23W  
Material: vidro/ABS

- Inclui aquecimento do espelho
- Temperatura de cor da luz regulável através de função touch



730lm | 3000K | 740lm | 4000K | 790lm | 6500K

Variante	Art. n.º	EUR
○ Prateado/leitoso 1100/1130/1210lm	1007200	560,00
● Transparente / Preto 730/740/790lm	1007202	560,00

TRUKKO 60  
WL

TRUKKO 90  
WL

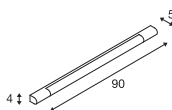
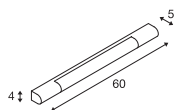

220-240V ~50/60Hz | 500mA  
Potência total: 9,2W  
Material: alumínio/plástico

220-240V ~50/60Hz | 500mA  
Potência total: 12W  
Material: alumínio/plástico



Down 750lm | 3000K

Down 1040lm | 3000K

Variante	Art. n.º	EUR
● Cromado	149762	161,00

Variante	Art. n.º	EUR
● Cromado	149772	191,00

149772 332

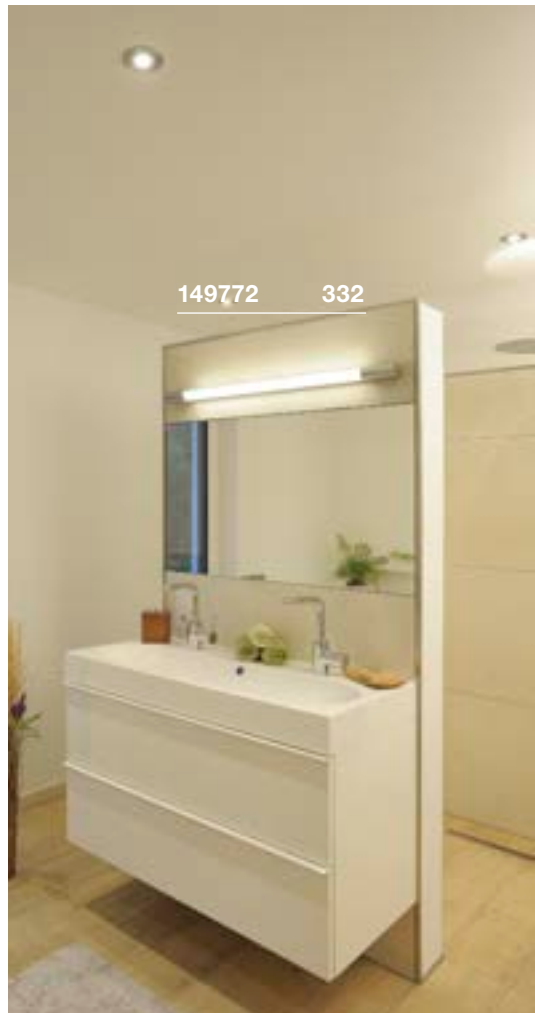

149772 332



## MARYLIN 40/60/90 WL



1002191 333

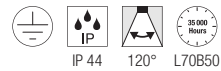
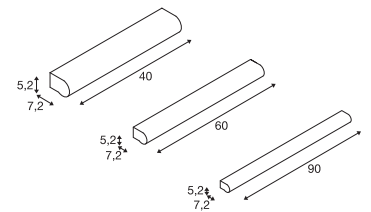

IP 44 120° L70B50

220-240V ~50/60Hz | 350mA

Potência total: 9,8W

Material: alumínio / policarbonato (PC)



Down 890lm | 3000K | 980lm | 4000K

Variante	Art. n.º	EUR
● Cromado   C: 40 cm 890/980lm   9.8W	<b>1002190</b>	<b>228,00</b>
● Cromado   C: 60 cm 1170/1280lm   16W	<b>1002191</b>	<b>286,00</b>
● Cromado   C: 90 cm 1800/1990lm   21W	<b>1002192</b>	<b>344,00</b>

WL 149  
WL, PHASE

WL 149  
WL, QT-DE12

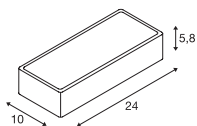
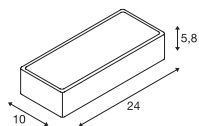

220-240V ~50/60Hz | 350mA  
Potência total: 14W  
Material: aço/vidro



Down 1050lm | 3000K

Variante	Art. n.º	EUR
<input type="radio"/> Branco	149511	151,00



220-240V ~50/60Hz  
Material: aço/vidro



Casquilho: R7s 78 mm

Variante	Art. n.º	EUR
<input type="radio"/> Branco/fosco	149471	70,00



LED R7s | 9W | 330°  
3000K | 1050lm | EE=E  
9kWh/1000h



Art. N.º: 1005287 | 24,00 EUR

149511 334



149471 334





1002228 335

WL 106  
E14

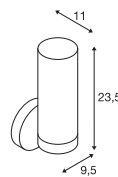

220-240V ~50/60Hz  
Material: alumínio/vidro



Casquilho: 1xE14 Máx. Ø: 3,6 cm C: 11 cm

Variante	Art. n.º	EUR
● Cromado	1002228	90,00



C35 | 4,2W | 320°  
2700K | 350lm | EE=G  
5kWh/1000h



Art. N.º: 1005285 | 8,50 EUR

WL 106  
E14

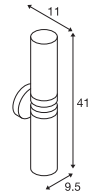

220-240V ~50/60Hz  
Material: alumínio/vidro



Casquilho: 2xE14 Máx. Ø: 3,6 cm C: 11 cm

Variante	Art. n.º	EUR
● Cromado	1002229	161,00



C35 | 4,2W | 320°  
2700K | 350lm | EE=G  
5kWh/1000h



Art. N.º: 1005285 | 8,50 EUR

1004971 337







### MIBO UP/DOWN WL, QT14

151282 337

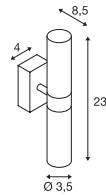

220-240V ~50/60Hz  
Material: alumínio/vidro



Casquilho: 2xG9

Variante	Art. n.º	EUR
● Cromado	151282	89,00



LED G9 | 3,6W | 300°  
3000K | 400lm | EE=E  
4kWh/1000h

Art. N.º: 1005286 | 9,99 EUR



### MAGANDA WL

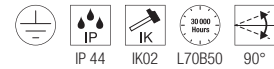
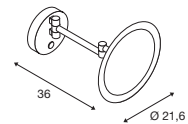

100-240V ~50/60Hz | 12V  
Potência total: 4,8W  
Material: aço/vidro



45.4lm | 2700K | 48lm | 3000K | 51lm | 4000K

Variante	Art. n.º	EUR
● Cromado	1004971	203,00

- Temperatura de cor da luz regulável através de interruptor na luminária.

1003507 339





### DORISA 30 WL

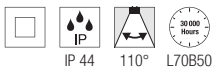
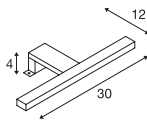

200-240V ~50Hz | 340mA  
Potência total: 5,2W  
Material: alumínio/plástico

- Alcance de fixação: 0-6 mm
- Conversível em luminária de espelho desmontando o suporte



Down 300lm | 4000K

Variante	Art. n.º	EUR
● Cromado	1000777	115,00

### DORISA 50 WL

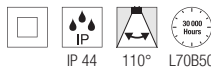
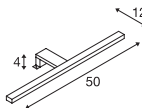

200-240V ~50Hz | 340mA  
Potência total: 6,6W  
Material: alumínio/plástico

- Alcance de fixação: 0-6 mm
- Conversível em luminária de espelho desmontando o suporte



Down 370lm | 4000K

Variante	Art. n.º	EUR
● Cromado	1000780	127,00

### GLENOS® 60 WL

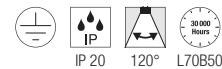
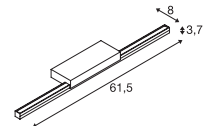

220-240V ~50/60Hz | 500mA  
Potência total: 12W  
Material: alumínio / policarbonato (PC)



Down 1170lm | 3000K / 4000K

Variante	Art. n.º	EUR
● Preto	1003506	181,00
○ Branco	1003507	181,00
● Cinzento	1003508	181,00

1000669 341





L-LINE 60  
WL

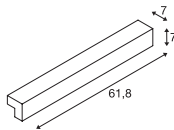

220-240V ~50/60Hz | 350mA  
Potência total: 10W  
Material: alumínio / policarbonato (PC)



Down 820lm | 3000K

Variante	Art. n.º	EUR
○ Branco	1001299	239,00
● Prateado	1001300	239,00

L-LINE 120  
WL

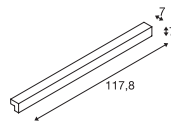

220-240V ~50/60Hz | 350mA  
Potência total: 18,5W  
Material: alumínio / policarbonato (PC)



Down 1650lm | 3000K

Variante	Art. n.º	EUR
○ Branco	1001303	330,00
● Prateado	1001304	330,00

Q-LINE®  
WL

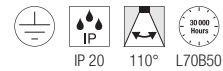
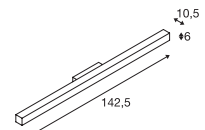

220-240V ~50/60Hz | 700mA  
Potência total: 45W  
Material: alumínio/acrílico



Down 3800lm | 3000K

Variante	Art. n.º	EUR
● Preto	1000669	464,00
○ Branco	1000668	464,00
● Cinzento	1000670	464,00

# CLASSES IP

Experimentar a luz de modo seguro. Com as luminárias para interior SLV e a classe de proteção IP certa para a zona de aplicação certa, isso não é problema. Nas casas de banho públicas as zonas 2 e 3 deverão ter as mesmas características da zona 1, mínimo IP65.



A iluminação num ambiente moderno de bem-estar deverá ser funcional, particularmente relaxante, mas também ao mesmo tempo segura, deve-se seleccionar a classe de proteção IP correta em função da área de utilização.

A abreviatura IP significa Ingress Protection (Grau de Proteção). No código IP o primeiro dígito indica a proteção contra corpos sólidos, enquanto o segundo descreve a proteção à humidade. O segundo dígito é particularmente importante na casa de banho e exterior (zonas húmidas).

## CORPOS SÓLIDOS    ÁGUA

Sem proteção	0	0	Sem proteção
Protegido contra acesso com as costas da mão (diâmetro > 50 mm)	1	1	Proteção contra queda vertical de pingos de água
Protegido contra acesso com o dedo (diâmetro > 12,5 mm)	2	2	Proteção contra queda de pingos de água quando o corpo da luminária está inclinado até 15°
Protegido contra acesso com uma ferramenta (diâmetro > 2,5 mm)	3	3	Proteção contra queda de água pulverizada em até 60° a partir da vertical
Protegido contra acesso com arame (diâmetro > 1 mm)	4	4	Proteção contra salpicos de água por todos os lados
Proteção total contra contacto (contra pó em quantidade nociva)	5	5	Proteção contra jatos de água (bico) de qualquer ângulo
Proteção total contra contacto (à prova de pó)	6	6	Proteção contra fortes jatos de água
		7	Proteção contra imersão temporária (<30 minutos)
		8	Proteção contra imersão permanente

### EXEMPLO IP 65:

O produto tem o nível 6, que é a máxima proteção contra o pó, e o nível 5 que é elevada proteção contra jatos de água. Pode estar classificado como sendo à prova de pó e à prova de água.







## PANTILO ROPE WL, G9

1007595 345



NEW

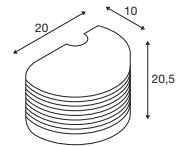

IP20

200-240V ~50/60Hz  
Material: aço



Casquinho: 1xG9

Máx. Ø: 3 cm

C: 6 cm

Variante	Art. n.º	EUR
● Dourado	1007595	179,00
○ Prateado	1007594	179,00



LED G9 | 3,6W | 300°  
3000K | 400lm | EE=E  
4kWh/1000h



Art. N.º: 1005286 | 9,99 EUR



1006441 347

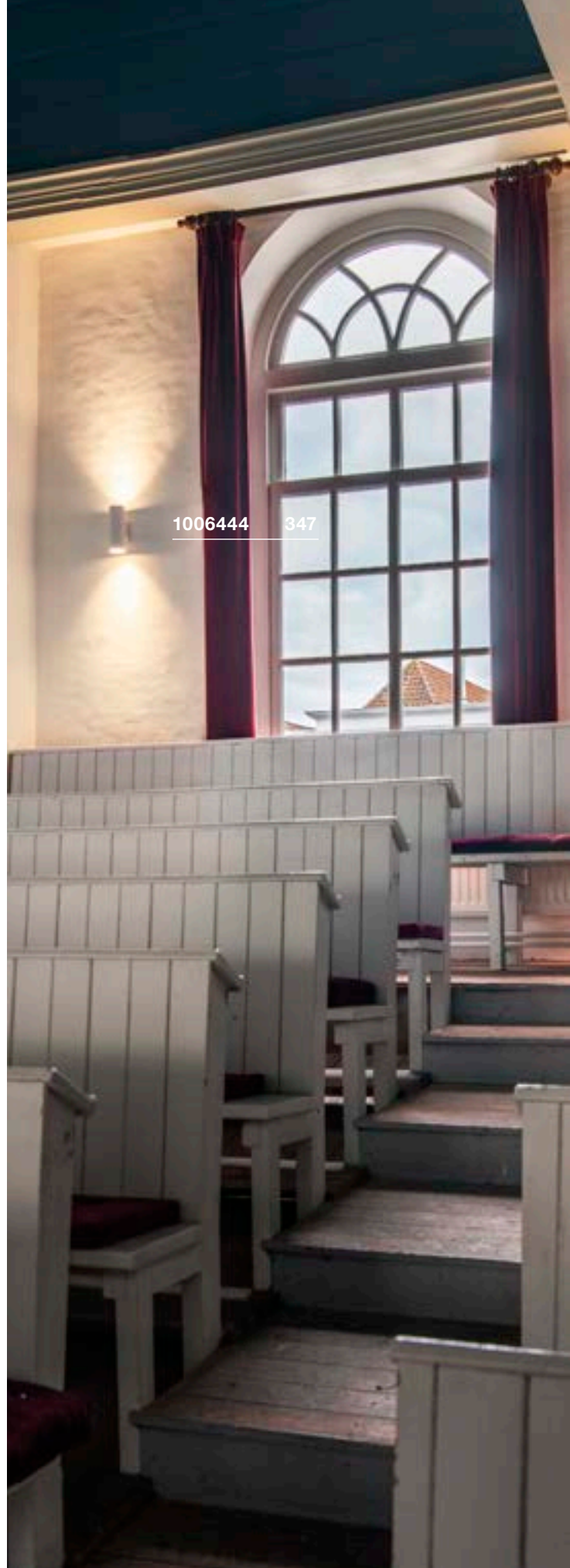

1006444 347



ASTO TUBE  
WL, single, GU10

ASTO TUBE  
WL, up/down, GU10

ASTO TUBE  
Refletor decorativo

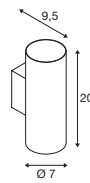
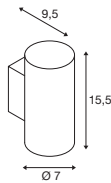

A: 3,95 cm  
Ø: 6,75 cm  
Material: policarbonato (PC)

Variante	Art. n.º	EUR
● Cromado preto	1007190	4,00
● Dourado	1006450	4,00
● Cromado	1006449	4,00
● Cobre	1006451	4,00



220-240V ~50/60Hz  
Material: alumínio



Casquilho: 1xGU10

Variante	Art. n.º	EUR
● Preto	1006441	60,00
○ Branco	1006442	60,00



220-240V ~50/60Hz  
Material: alumínio



Casquilho: 2xGU10

Variante	Art. n.º	EUR
● Preto	1006443	80,00
○ Branco	1006444	80,00



1004969 + 1004660 349



1004657 + 1004663 349





### MANA BASE WL, Redondo, PHASE

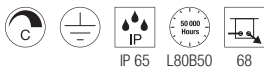
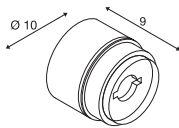

220-240V ~50/60Hz | 350mA  
Potência total: 15W  
Material: alumínio / policarbonato (PC)



Down 800lm | 2700K | 820lm | 3000K

Variante	Art. n.º	EUR
● Antracite	1006319	189,00

### MANA BASE Redondo

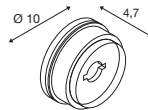

Material: alumínio / policarbonato (PC)

- Base sem fonte de luz para abajures redondos da série MANA

Variante	Art. n.º	EUR
● Antracite	1004969	26,00

### MANA 40 Abajur, redondo



A: 6 cm  
Ø: 40 cm  
Material: feltro/alumínio

- Os abajures de feltro poderão absorver o som se colocarmos vários numa parede.

Variante	Art. n.º	EUR
● Cinzento	1004661	99,00
● Bege	1004660	99,00

### MANA 60 Abajur, redondo



A: 6 cm  
Ø: 60 cm  
Material: feltro/alumínio

- Os abajures de feltro podem absorver o som ao serem colocados vários na parede

Variante	Art. n.º	EUR
● Cinzento	1004663	145,00
● Bege	1004662	145,00

1000613 + 1000824 351





### MANA WL, Base, PHASE

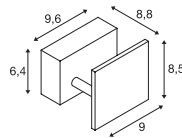

220-240V ~50/60Hz | 350mA  
Potência total: 8,3W  
Material: alumínio/aço



Down 520lm | 2000-3000K

Variante	Art. n.º	EUR
○ Branco	<b>1000613</b>	<b>145,00</b>

### MANA Abajur



C: 12 cm A: 10 cm P: 9 cm  
Material: madeira

- Adequado apenas para 1000613

Variante	Art. n.º	EUR
○ Branco	<b>1000618</b>	<b>51,00</b>
● Cinzento/Castanho	<b>1000616</b>	<b>51,00</b>

### MANA Abajur



L: 13,6 cm A: 10 cm P: 9,5 cm  
Material: gesso/aço

- Adequado apenas para 1000613
- Pode ser pintado/forrado individualmente à cor da parede

Variante	Art. n.º	EUR
○ Branco	<b>1000824</b>	<b>36,00</b>

1000615 + 1000823 353







### MANA WL, Base, PHASE

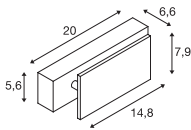

220-240V ~50/60Hz | 350mA  
Potência total: 15W  
Material: alumínio/aço



Down 700lm | 2000-3000K

Variante	Art. n.º	EUR
○ Branco	1000614	169,00

### MANA WL, Base

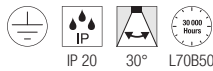
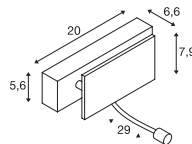

220-240V ~50/60Hz | 350/500mA  
Potência total: 11W  
Material: alumínio/aço

- Projetor com interruptor separado



Down 650lm | 3000K

Variante	Art. n.º	EUR
○ Branco/cromado	1000615	215,00

### MANA Abajur



C: 29 cm A: 9,5 cm P: 7 cm  
Material: madeira

- Adequado apenas para 1000614/1000615

Variante	Art. n.º	EUR
○ Branco	1000623	61,00
● Cinzento/Castanho	1000621	61,00

### MANA Abajur



L: 30,9 cm A: 9,5 cm P: 7,4 cm  
Material: gesso/aço

- Adequado apenas para 1000614/1000615
- Pode ser pintado/forrado individualmente à cor da parede

Variante	Art. n.º	EUR
○ Branco	1000825	33,75

1006308 355





### OCULUS WL, single, PHASE



### OCULUS UP/DOWN WL, PHASE



1004671 355

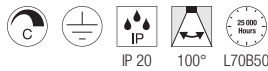
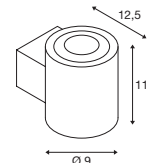
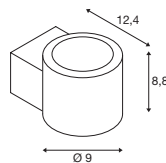

220-240V ~50/60Hz | 350mA  
Potência total: 8,5W  
Material: alumínio/vidro



220-240V ~50/60Hz | 700mA  
Potência total: 15W  
Material: alumínio/vidro

- Inclui lente fosca adicional



Down 570lm | 2000-3000K



Up Down 22lm | 2000K - 555lm | 3000K

Variante	Art. n.º	EUR
● Preto	1006307	229,00
○ Branco	1006308	229,00

Variante	Art. n.º	EUR
● Preto	1004670	249,00
○ Branco	1004671	249,00

PLASTRA  
WL, Cube, QT14

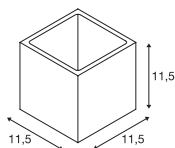

220-240V ~50/60Hz  
Material: gesso/aço

- Pode ser pintado/forrado individualmente à cor da parede



Casquilho: 1xG9

Variante	Art. n.º	EUR
<input type="radio"/> Branco	148018	54,00



LED G9 | 3,6W | 300°  
3000K | 400lm | EE=E  
4kWh/1000h

Art. N.º: 1005286 | 9,99 EUR



PLASTRA  
WL, Cubes

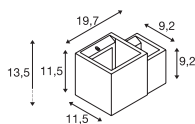
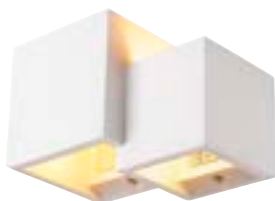

220-240V ~50/60Hz  
Material: gesso/aço

- Pode ser pintado/forrado individualmente à cor da parede



Casquilho: 2xG9 Máx. Ø: 7 cm C: 4 cm

Variante	Art. n.º	EUR
<input type="radio"/> Branco	1004733	59,00



LED G9 | 3,6W | 300°  
3000K | 400lm | EE=E  
4kWh/1000h

Art. N.º: 1005286 | 9,99 EUR

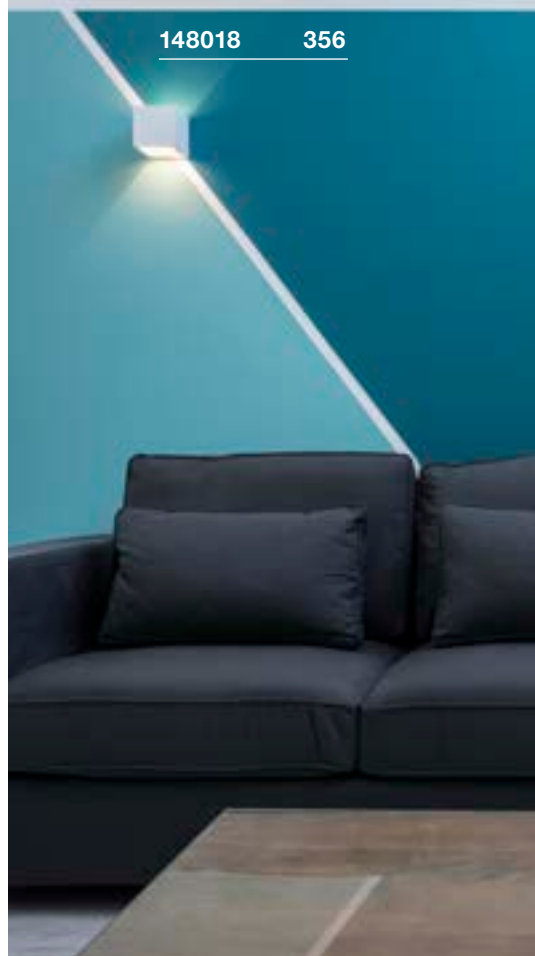

148018 356



1002238 357



**PLASTRA**  
WL, retangular, QT-DE12

**PLASTRA**  
WL, E14

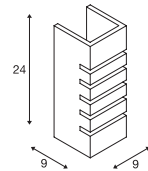
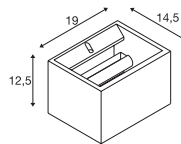

220-240V ~50/60Hz  
Material: gesso/aço

220-240V ~50/60Hz  
Material: gesso/aço

- Pode ser pintado/forrado individualmente à cor da parede

- Pode ser pintado/forrado individualmente à cor da parede



Casquilho: 1xR7s 118 mm

Casquilho: 1xE14

Variante	Art. n.º	EUR
<input type="radio"/> Branco	1002238	79,00

Variante	Art. n.º	EUR
<input type="radio"/> Branco	148010	52,00



LED R7s | 15W | 330°  
3000K | 2000lm | EE=E  
15kWh/1000h



Art. N.º: 1005288 | 28,50 EUR



C35 | 4,2W | 320°  
2700K | 350lm | EE=G  
5kWh/1000h



Art. N.º: 1005285 | 8,50 EUR



148010 357

1004732 359



148091 359

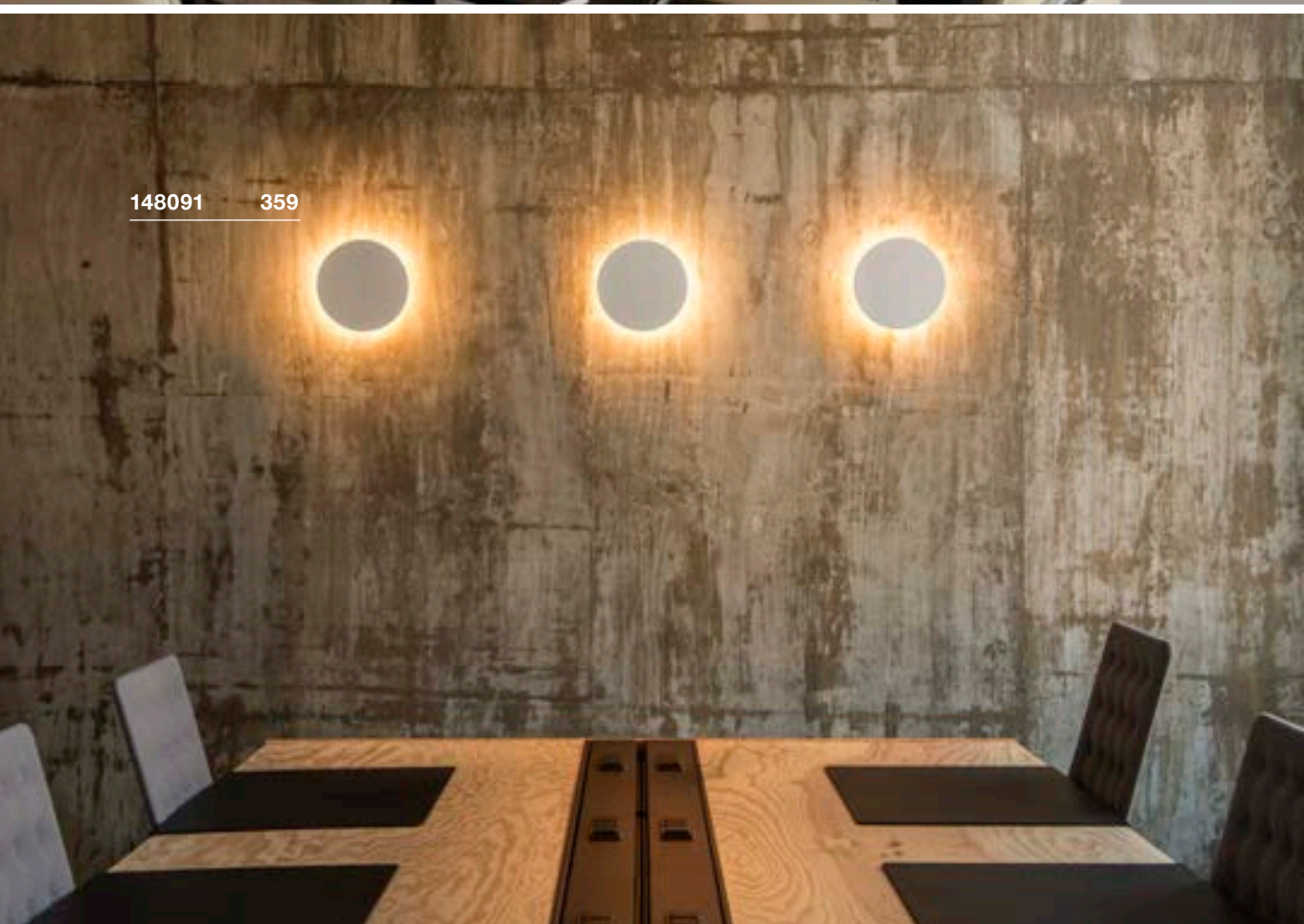



PLASTRA  
WL, semicircular

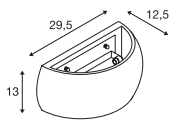

220-240V ~50/60Hz  
Material: gesso/aço

- Pode ser pintado/forrado individualmente à cor da parede



Casquilho:  
1xR7s 118 mm Máx. Ø: 2 cm C: 11,8 cm

Variante	Art. n.º	EUR
<input type="radio"/> Branco	1004732	73,00

PLASTRA  
WL, circular

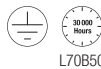
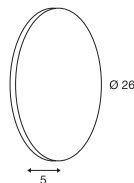

100-240V ~50/60Hz | 12V  
Potência total: 6,5W  
Material: gesso/aço

- Pode ser pintado/forrado individualmente à cor da parede



Down 375lm | 3000K

Variante	Art. n.º	EUR
<input type="radio"/> Branco	148091	168,00

PLASTRA  
WL, quadrada

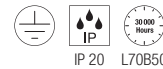
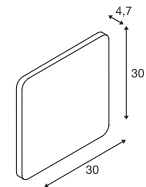

100-240V ~50/60Hz | 12V  
Potência total: 10,5W  
Material: gesso/aço

- Pode ser pintado/forrado individualmente à cor da parede



Down 650lm | 3000K

Variante	Art. n.º	EUR
<input type="radio"/> Branco	148019	216,00



LED R7s | 15W | 330°  
3000K | 2000lm | EE=E  
15kWh/1000h



Art. N.º: 1005288 | 28,50 EUR



148060 360

## PLASTRA WL, QPAR51

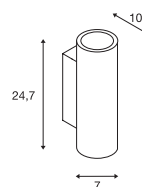

148013 361



220-240V ~50/60Hz  
Material: gesso/aço

- Pode ser pintado/forrado individualmente à cor da parede

**SOCKET**  
**INSIDE**

<35  
W

Casquilho: 2xGU10

Variante	Art. n.º	EUR
○ Branco	148060	67,00



LED GU10 51mm | 6W | 36°  
2200-2700K | 360lm | EE=G  
6kWh/1000h



Art. N.º: 1005273 | 9,99 EUR





PLASTRA 101  
WL, E14

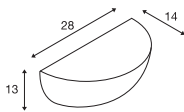

220-240V ~50/60Hz  
Material: gesso/aço

- Pode ser pintado/forrado individualmente à cor da parede



Casquilho: 1xE14 Máx. Ø: 4,5 cm C: 11 cm

Variante	Art. n.º	EUR
○ Branco	148013	54,00



C35 | 4,2W | 320°  
2700K | 350lm | EE=G  
5kWh/1000h



Art. N.º: 1005285 | 8,50 EUR

PLASTRA  
WL, Curve, QT-DE12

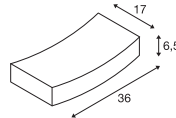

220-240V ~50/60Hz  
Material: gesso/aço

- Pode ser pintado/forrado individualmente à cor da parede



Casquilho: 1xR7s 78 mm

Variante	Art. n.º	EUR
○ Branco	148012	73,00



LED R7s | 9W | 330°  
3000K | 1050lm | EE=E  
9kWh/1000h



Art. N.º: 1005287 | 24,00 EUR

PLASTRA 104  
WL, QT14

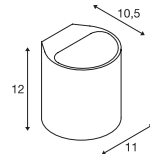

220-240V ~50/60Hz  
Material: gesso/aço

- Pode ser pintado/forrado individualmente à cor da parede



Casquilho: 1xG9

Variante	Art. n.º	EUR
○ Branco	148016	54,00



LED G9 | 3,6W | 300°  
3000K | 400lm | EE=E  
4kWh/1000h



Art. N.º: 1005286 | 9,99 EUR

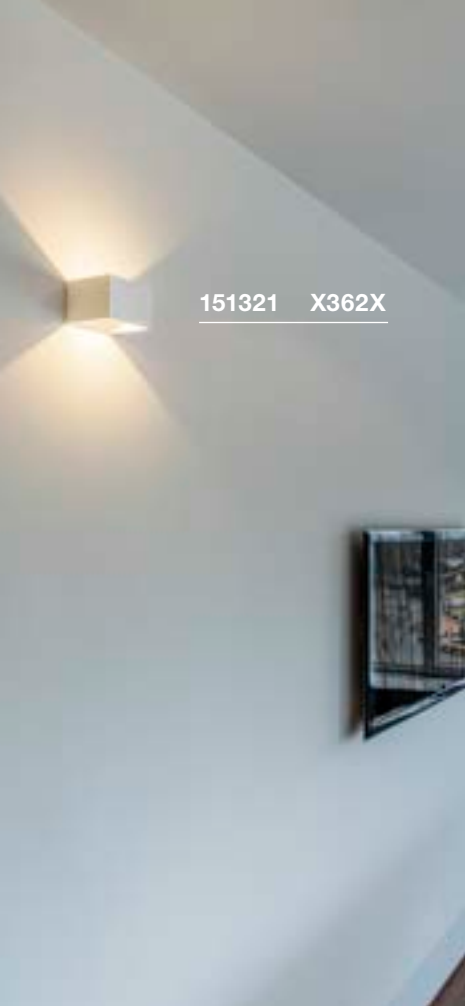

151321 X362X



1000638 362

## LOGS IN WL

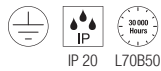
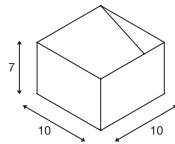

100-240V ~50/60Hz | 500mA  
Potência total: 6W  
Material: alumínio



Down 300lm | 470lm | 3000K

Variante	Art. n.º	EUR
● Preto/dourado 300lm	151320	118,00
○ Branco 470lm	151321	118,00

## LOGS IN WL, PHASE

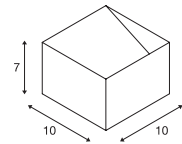

220-240V ~50/60Hz | 250mA  
Potência total: 11W  
Material: alumínio



Down 430-690lm | 2000-3000K

Variante	Art. n.º	EUR
● Preto/dourado 430lm	1000638	159,00
○ Branco 690lm	1000639	159,00
● Alumínio/branco 690lm	1000640	159,00



1002843 363

LOGS IN L  
WL, PHASE

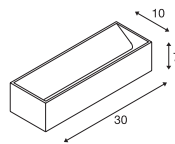

220-240V ~50/60Hz | 500mA  
Potência total: 18W  
Material: alumínio



Down 1100lm | 1600lm | 3000K

Variante	Art. n.º	EUR
● Preto/dourado 1100lm	1002842	205,00
○ Branco 1600lm	1002844	205,00
● Alumínio/branco 1600lm	1002843	205,00

LOGS IN L  
WL, PHASE

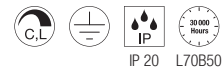
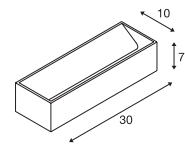

220-240V ~50/60Hz | 500mA  
Potência total: 21W  
Material: alumínio



Down 1000lm | 2000-3000K

Variante	Art. n.º	EUR
● Preto/dourado 1000lm	1002928	275,00
○ Branco 1390lm	1002929	275,00



1002928 363



1003467 364



1003468 364

## QUAD FRAME 14 WL

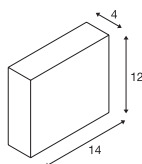

100-240V ~50/60Hz | 350mA  
Potência total: 4,4W  
Material: alumínio



Down 165lm | 2700K | 175lm | 3000K

Variante	Art. n.º	EUR
<input type="radio"/> Branco	1003467	99,00

## QUAD FRAME 19 WL

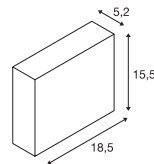

220-240V ~50/60Hz | 500mA  
Potência total: 11W  
Material: alumínio



Down 580lm | 2700K | 640lm | 3000K

Variante	Art. n.º	EUR
<input type="radio"/> Branco	1003468	119,00



1000422 365

SHELL 15  
WL, PHASE

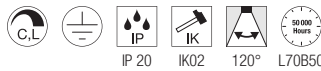
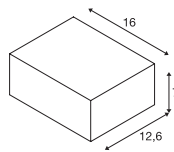

220-240V ~50/60Hz | 350mA  
Potência total: 15W  
Material: alumínio/acrílico



Down 1400lm | 3000K

Variante	Art. n.º	EUR
<input type="radio"/> Branco	1000422	252,00

SHELL 30  
WL, PHASE

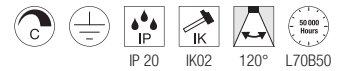
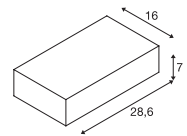

220-240V ~50/60Hz | 700mA  
Potência total: 54W  
Material: alumínio/acrílico



Down 5600lm | 3000K

Variante	Art. n.º	EUR
<input type="radio"/> Branco	1000423	378,00



1000423 365



151275 366

## ASSO 300 WL, PHASE

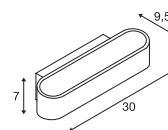

151410 366



IP 20 L70B50

220-240V ~50/60Hz | 500mA

Potência total: 12W

Material: alumínio/aço



Down

975lm | 3000K

Variante	Art. n.º	EUR
○ Branco	151271	215,00
● Alumínio/branco	151275	226,00



ASSO 300  
WL, PHASE

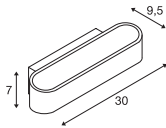

220-240V ~50/60Hz | 500mA  
Potência total: 21W  
Material: alumínio/aço



Down 1340lm | 2000-3000K

Variante	Art. n.º	EUR
○ Branco	1000634	252,00

OSSA 180  
WL, QT-DE12

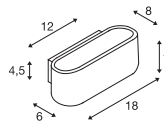

220-240V ~50/60Hz  
Material: alumínio/aço



Casquilho: 1xR7s 78 mm

Variante	Art. n.º	EUR
● Preto	151450	96,00
○ Branco	151451	96,00
● Alumínio	151456	102,00



LED R7s | 9W | 330°  
3000K | 1050lm | EE=E  
9kWh/1000h



Art. N.º: 1005287 | 24,00 EUR

OSSA 300  
WL, QT-DE12

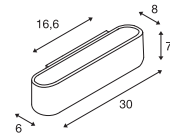

220-240V ~50/60Hz  
Material: alumínio/aço



Casquilho: 1xR7s 118 mm

Variante	Art. n.º	EUR
● Preto	151410	117,00
○ Branco	151411	117,00



LED R7s | 15W | 330°  
3000K | 2000lm | EE=E  
15kWh/1000h



Art. N.º: 1005288 | 28,50 EUR

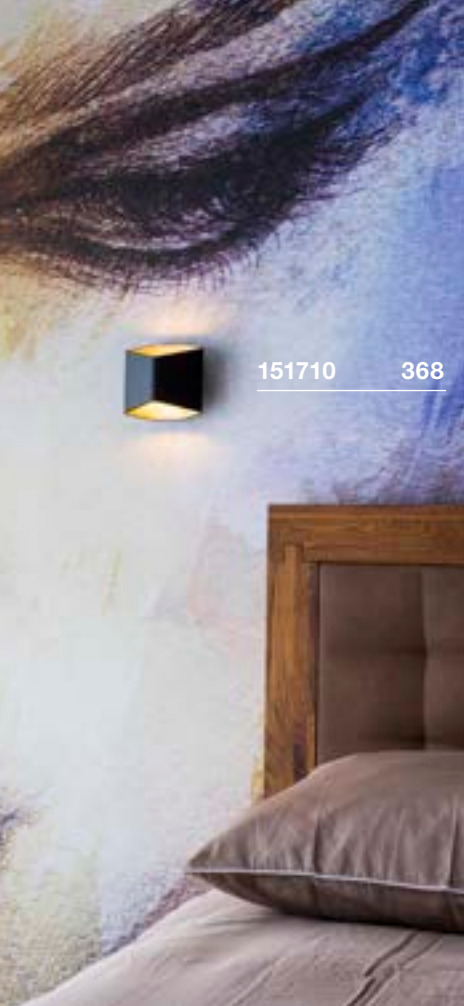

151710 368



151740 368

## CARISO WL, PHASE

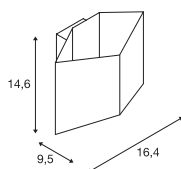

220-240V ~50/60Hz | 500mA  
Potência total: 9,2W  
Material: alumínio/aço



Down 250lm | 2700K  
560lm | 3000K

Variante	Art. n.º	EUR
● Preto/dourado 250lm   2700K	<b>151710</b>	<b>169,00</b>
○ Branco 560lm   3000K	<b>151711</b>	<b>165,00</b>

## CARISO WL, PHASE

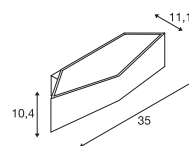
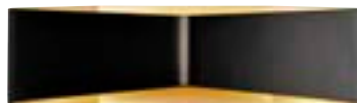

220-240V ~50/60Hz | 500mA  
Potência total: 21W  
Material: alumínio/aço



Down 580lm | 1700-2700K  
1030lm | 2000-3000K

Variante	Art. n.º	EUR
● Preto/dourado 580lm   1700-2700K	<b>151740</b>	<b>289,00</b>
○ Branco 1030lm   2000-3000K	<b>151741</b>	<b>279,00</b>





## CHROMBO WL, PHASE

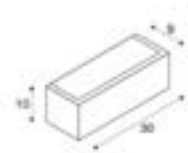

1003317 369



220-240V ~50/60Hz | 350mA  
Potência total: 11W  
Material: aço/vidro



Down

700lm | 3000K

Variante	Art. n.º	EUR
○ Branco	1003316	171,00
● Cinzento	1003317	171,00

DIRETO 60  
WL, PHASE

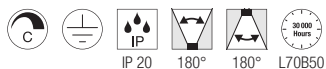
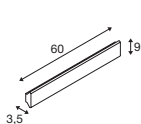
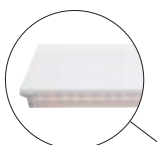

220-240V ~50/60Hz | 500mA  
Potência total: 14W  
Material: alumínio



Up 590lm | 2700K | 625lm | 3000K  
Down

Variante	Art. n.º	EUR
● Preto	1004740	199,00
○ Branco	1004741	199,00

DIRETO 90  
WL, PHASE

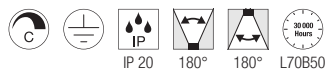
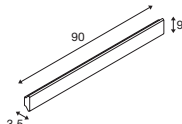
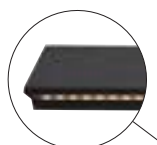

220-240V ~50/60Hz | 500mA  
Potência total: 20W  
Material: alumínio



Up 840lm | 2700K | 880lm | 3000K  
Down

Variante	Art. n.º	EUR
● Preto	1004742	239,00
○ Branco	1004743	239,00

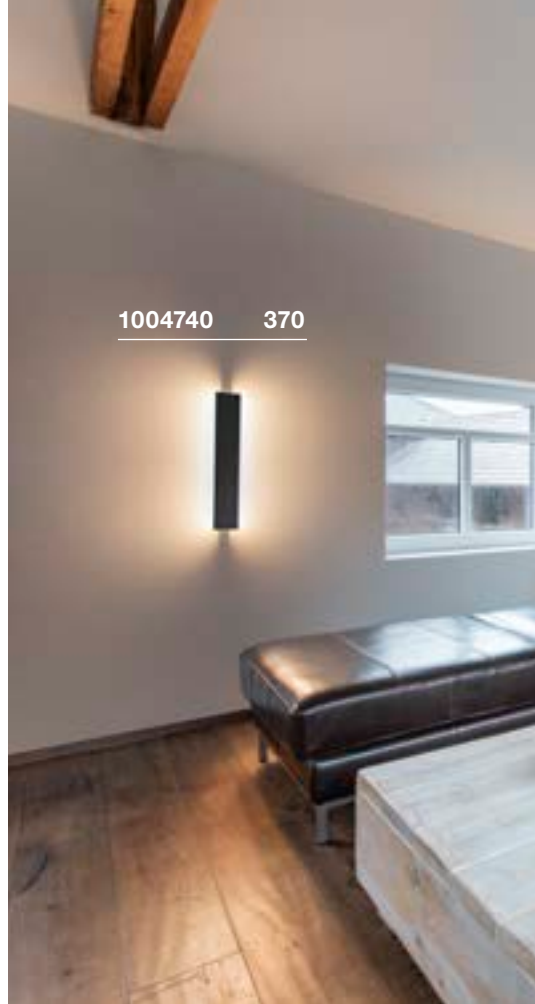

1004740 370



1004743 370



### ARLINA 60 WL

### ARLINA 130 WL

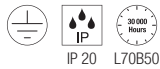
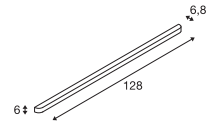
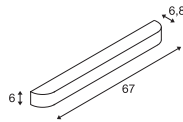

220-240V ~50/60Hz | 500mA  
Potência total: 23W  
Material: alumínio/vidro

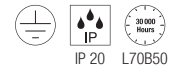

220-240V ~50/60Hz | 700mA  
Potência total: 28W  
Material: alumínio/vidro



Down 1550lm | 3000K



Down 2400lm | 3000K

Variante	Art. n.º	EUR
● Alumínio	1002239	253,00

Variante	Art. n.º	EUR
● Alumínio	1002240	325,00



147529 373

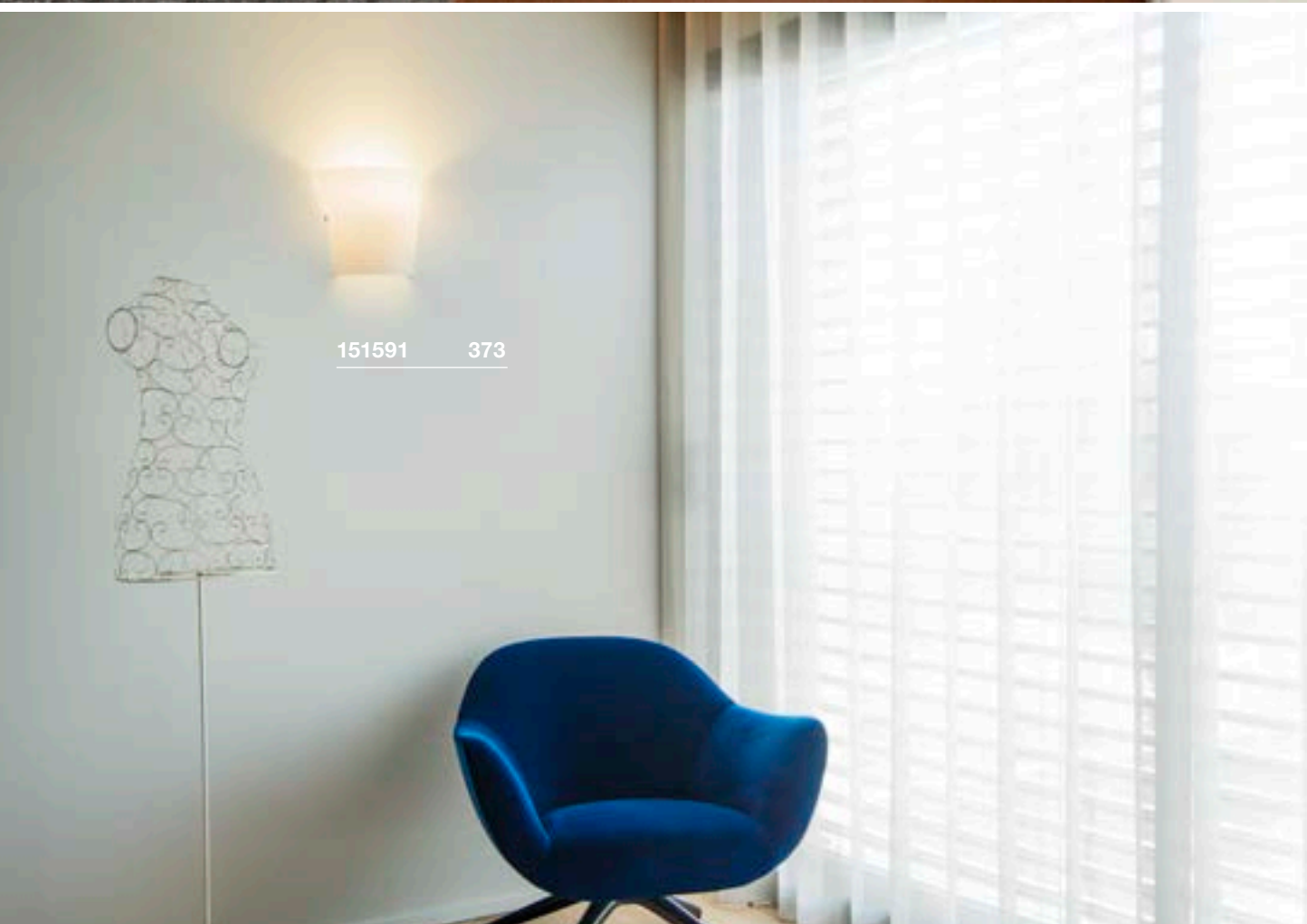

151591 373



ANDREAS  
WL, QT-DE12

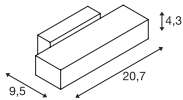

220-240V ~50/60Hz  
Material: alumínio/aço



Casquilho: 1xR7s 118 mm

Variante	Art. n.º	EUR
● Preto	1002927	108,00
○ Branco	1002925	108,00



LED R7s | 15W | 330°  
3000K | 2000lm | EE=E  
15kWh/1000h



Art. N.º: 1005288 | 28,50 EUR

DENA 30  
WL, E14

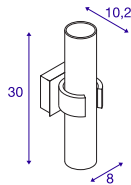

220-240V ~50/60Hz  
Material: alumínio



Casquilho: 2xE14 Máx. Ø: 5,1 cm | C: 9,6 cm

Variante	Art. n.º	EUR
● Alumínio	147529	103,00



C35 | 4,2W | 320°  
2700K | 350lm | EE=G  
5kWh/1000h



Art. N.º: 1005285 | 8,50 EUR

BASKET  
WL, E27

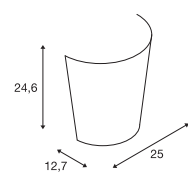

220-240V ~50/60Hz  
Material: vidro



Casquilho: 1xE27 Máx. Ø: 5,2 cm | C: 15,2 cm

Variante	Art. n.º	EUR
○ Branco	151591	97,00



LED E27 | 8W | 240°  
3000K | 880lm | EE=E  
8kWh/1000h



Art. N.º: 1005289 | 10,25 EUR

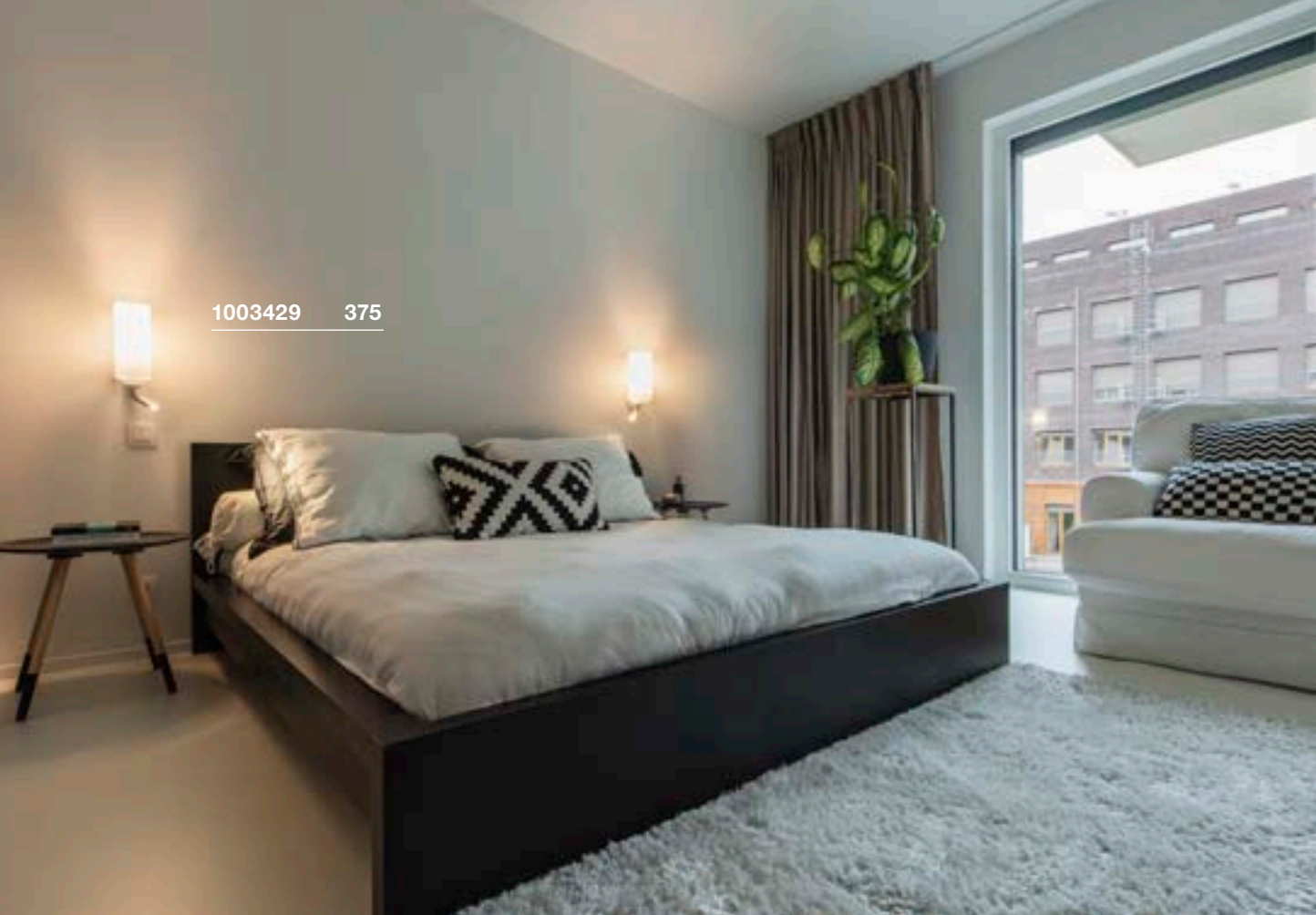

1003429 375

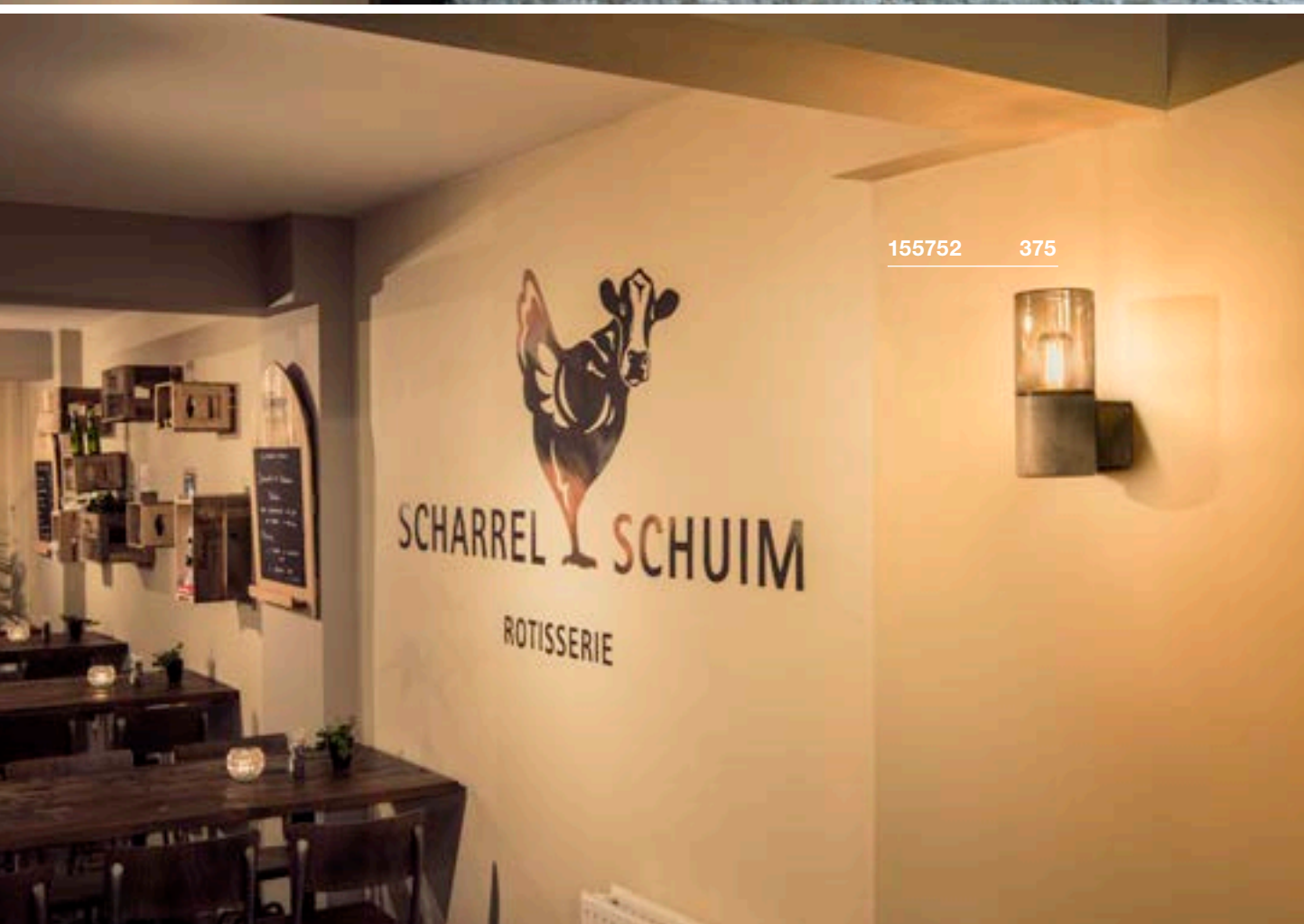

155752 375



### QUADRASS WL, E27

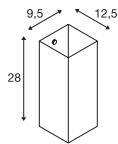

220-240V ~50/60Hz  
Material: aço/vidro



Casquilho: 1xE27 Máx. Ø: 6,5 cm | C: 18 cm

Variante	Art. n.º	EUR
● Preto/leitoso	1003430	140,00
○ Branco/leitoso	1003431	140,00



LED E27 | 13,2W | 220°  
2700K | 1300lm | EE=F  
13kWh/1000h



Art. N.º: 1005302 | 12,25 EUR

### QUADRASS SPOT WL, E27

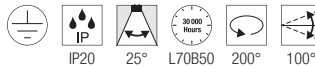
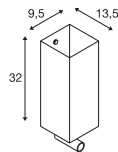

100-240V ~50/60Hz | 700mA  
Potência total: 2W  
Material: aço/vidro

- Interruptores no corpo da luminária
- Fontes de luz com interruptores individuais



Down 200lm | 3000K



Casquilho: 1xE27 Máx. Ø: 6,5 cm | C: 18 cm

Variante	Art. n.º	EUR
● Preto	1003428	211,00
○ Branco	1003429	211,00



A60 | 7,5W | 320°  
2700K | 800lm | EE=F  
8kWh/1000h



Art. N.º: 1005303 | 9,60 EUR

### LISENNE WL, E27

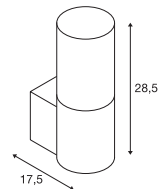

220-240V ~50/60Hz  
Material: basalto/vidro



Casquilho: 1xE27 Máx. Ø: 5,9 cm | C: 15 cm

Variante	Art. n.º	EUR
● Cinzento/Cast.	155752	241,00



LED E27 | 8W | 240°  
3000K | 880lm | EE=E  
8kWh/1000h



Art. N.º: 1005289 | 10,25 EUR

**FITU**  
Haste de suporte para parede

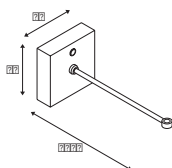

Material: aço

- Luminárias suspensas a combinar, ver página 295

Variante	Art. n.º	EUR
● Preto	1004682	64,00

**FITU CUBE**  
WL, E27

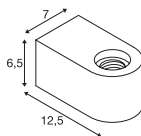

220-240V ~50/60Hz  
Material: aço



Casquilho: 1xE27 Máx. Ø: 12,5 cm

Variante	Art. n.º	EUR
● Preto	1004738	80,00
○ Branco	1004739	80,00



A60 | 7,5W | 180°  
2700K | 720lm | EE=F  
8kWh/1000h



Art. N.º: 1005305 | 19,00 EUR

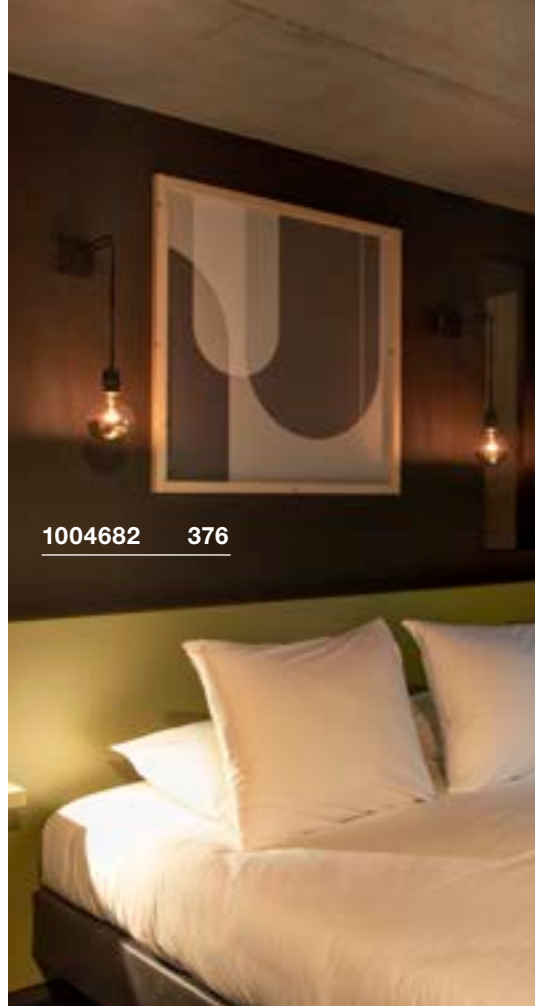

1004682 376

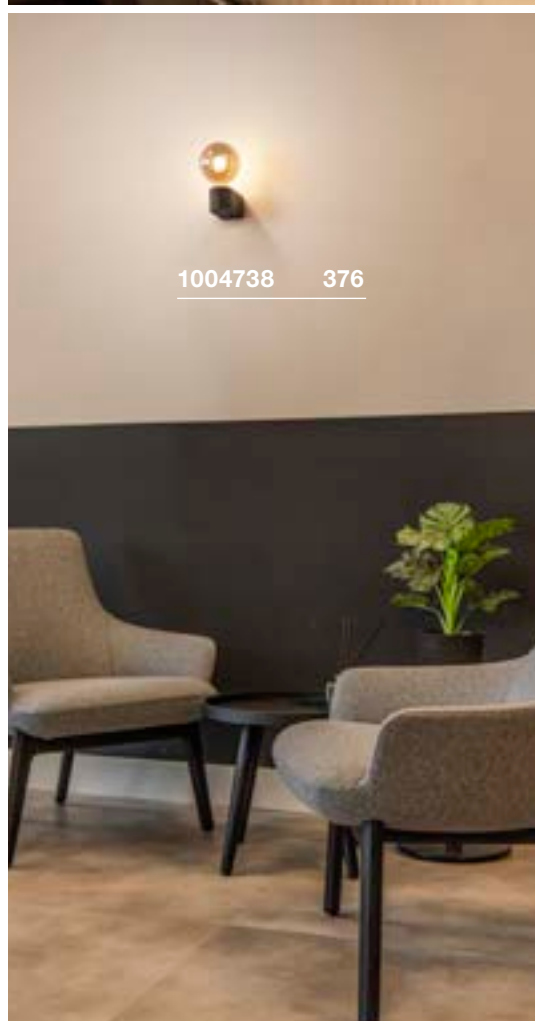

1004738 376





1000327 377

THEO UP/DOWN  
WL, QPAR51

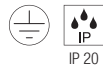
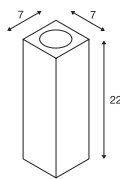

220-240V ~50/60Hz  
Material: alumínio



Casquilho: 2xGU10

Variante	Art. n.º	EUR
● Antracite	1000330	115,00
○ Branco	1000327	115,00
● Alumínio	1000329	122,00



LED GU10 51mm | 6W | 38°  
2700K | 450lm | EE=F  
6kWh/1000h



Art. N.º: 1005077 | 7,50 EUR

SOLID CUBE  
WL, QT14

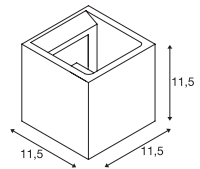

220-240V ~50/60Hz  
Material: betão



Casquilho: 1xG9

Variante	Art. n.º	EUR
● Cinzento	1000910	97,00
● Preto	1000911	97,00



LED G9 | 3,6W | 300°  
3000K | 400lm | EE=E  
4kWh/1000h



Art. N.º: 1005286 | 9,99 EUR



1000910 377

151803 379





ENOLA B  
WL, QPAR51

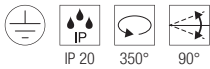
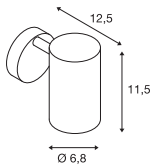

220-240V ~50/60Hz  
Material: alumínio/aço

- Interruptor no corpo da luminária



Casquilho: 1xGU10

Máx. C: 6 cm

Variante	Art. n.º	EUR
● Preto	1000729	81,00
○ Branco	1000730	81,00



LED GU10 51mm | 6W | 38°  
2700K | 450lm | EE=F  
6kWh/1000h



Art. N.º: 1005077 | 7,50 EUR



Artigo	Art. n.º	EUR
Anel decorativo		
● Preto	151840	8,95

ENOLA B  
WL, QPAR51

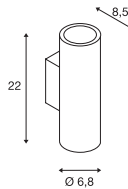

220-240V ~50/60Hz  
Material: alumínio/aço



Casquilho: 2xGU10

Máx. C: 8,5 cm

Variante	Art. n.º	EUR
● Preto	151800	94,00
○ Branco	151801	94,00
● Dourado	151803	104,00



LED GU10 51mm | 6W | 38°  
2700K | 450lm | EE=F  
6kWh/1000h



Art. N.º: 1005077 | 7,50 EUR



Artigo	Art. n.º	EUR
Anel decorativo		
● Preto	151840	8,95

ASTINA UP/DOWN  
WL, QPAR51

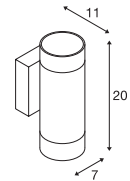

220-240V ~50/60Hz  
Material: alumínio/aço



Casquilho: 2xGU10

Variante	Art. n.º	EUR
● Preto	1002933	112,00
○ Branco	1002931	112,00



LED GU10 51mm | 6W | 36°  
2200-2700K | 360lm | EE=G  
6kWh/1000h



Art. N.º: 1005273 | 9,99 EUR

FENDA  
WL, Base, E27

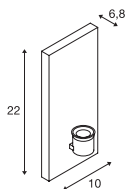

220-240V ~50/60Hz  
Material: aço/plástico



Casquilho: 1xE27 Máx. Ø: 5,1 cm C: 20 cm

Variante	Art. n.º	EUR
○ Branco	1001272	52,00



LED E27 | 8W | 240°  
3000K | 880lm | EE=E  
8kWh/1000h



Art. N.º: 1005289 | 10,25 EUR

FENDA  
Abajur



L: 23 cm A: 30 cm P: 12 cm  
Material: têxtil/aço

Variante	Art. n.º	EUR
● Preto	1001273	38,50
● Preto/cobre	1001274	44,75
○ Branco	1001275	38,50
● Bege	1001276	38,50

1001272 + 1001273 380

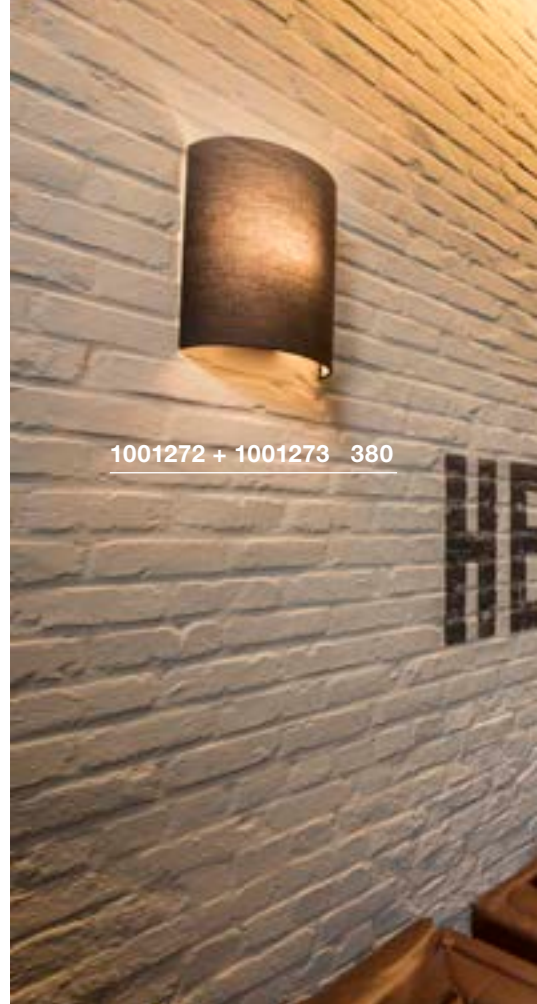

149452 381





### KENKUA SPOT WL, E27

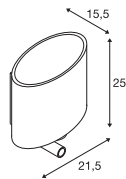

100-240V ~50/60Hz | 700mA  
Potência total: 2W  
Material: aço/vidro

- Fontes de luz com interruptores individuais.



Down 200lm | 3000K



Casquilho: 1xE27 Máx. Ø: 6,5 cm | C: 12 cm

Variante	Art. n.º	EUR
● Cromado	1002855	206,00



A60 | 7,5W | 320°  
2700K | 800lm | EE=F  
8kWh/1000h



Art. N.º: 1005303 | 9,60 EUR

### COUPA FLEX WL

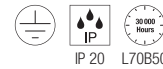
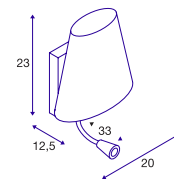

220-240V ~50/60Hz | 700mA  
Potência total: 3,2W  
Material: aço/vidro

- Fontes de luz com interruptores individuais.



Down 140lm | 3000K



Casquilho: 1xG9 Máx. C: 9 cm

Variante	Art. n.º	EUR
● Cromado/leitoso	149452	206,00



LED G9 | 3,6W | 300°  
3000K | 400lm | EE=E  
4kWh/1000h



Art. N.º: 1005286 | 9,99 EUR



KARPO MAGN  
CW, single, PHASE

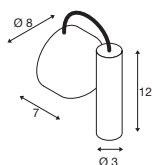

220-240V ~50/60Hz | 500mA  
Potência total: 6,2W  
Material: aço/alumínio

- A cabeça da luminária pode ser livremente posicionada devido ao suporte magnético



Down 350lm | 430lm | 3000K

Variante	Art. n.º	EUR
● Preto		
350lm	<b>1004706</b>	<b>197,00</b>
○ Branco		
430lm	<b>1004707</b>	<b>197,00</b>

KARPO GOOSE  
WL

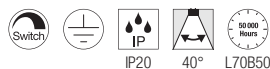
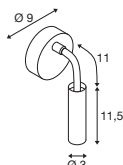

220-240V ~50/60Hz | 12V  
Potência total: 5,8W  
Material: alumínio/aço

- A intensidade da luz é regulável através do interruptor na cabeça da luminária



Down 380lm | 420lm | 3000K

Variante	Art. n.º	EUR
● Preto		
380lm	<b>1006162</b>	<b>179,00</b>
○ Branco		
420lm	<b>1006161</b>	<b>179,00</b>

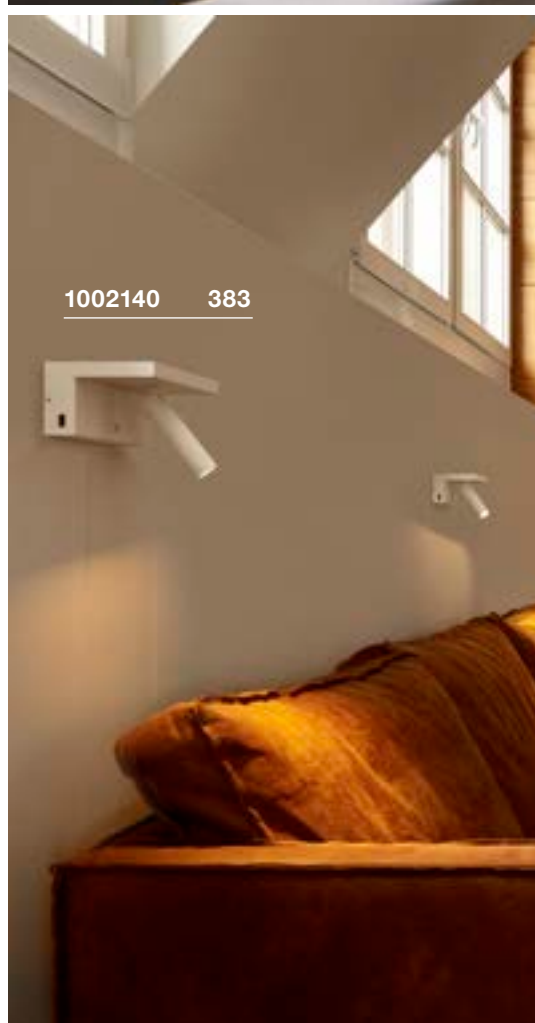

1002140 383



### KARPO 30 WL, single

### KARPO WL



1004707 382

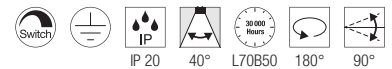
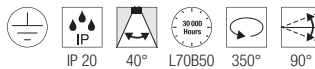
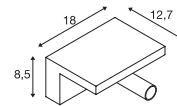
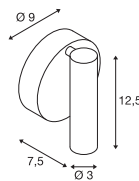

100-240V ~50/60Hz | 500mA  
Potência total: 6W  
Material: alumínio/aço

220-240V ~50/60Hz | 500mA  
Potência total: 6,8W  
Material: alumínio

- Interruptor no corpo da luminária

- 2 ligações USB 1,5 Amp. máx.
- 3 níveis reguláveis através de interruptor no corpo da luminária



Down 370lm | 400lm 3000K

Down 390lm | 3000K

Variante	Art. n.º	EUR
● Preto 370lm	152340	125,00
○ Branco 400lm	152341	125,00

Variante	Art. n.º	EUR
○ Branco	1002140	242,00





1003457 384

## SOMNILA SPOT WL, Esquerda

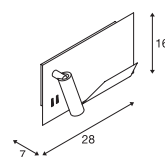

1003459 385

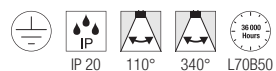

100-240V ~50/60Hz | 12V

Potência total: 15W

Material: alumínio/aço

- 1 Ligação USB; 5VDC 2A máx.
- Fontes de luz com interruptores individuais.



Down

120lm | 3000K

Variante	Art. n.º	EUR
● Preto 490lm	1003455	232,00
○ Branco 770lm	1003457	232,00





### SOMNILA SPOT WL, Direita

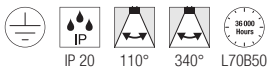

100-240V ~50/60Hz | 12V  
Potência total: 15W  
Material: alumínio/aço

- 1 Ligação USB; 5VDC 2A máx.
- Fontes de luz com interruptores individuais.



Down 120lm | 3000K

Variante	Art. n.º	EUR
● Preto 490lm	1003456	232,00
○ Branco 770lm	1003458	232,00

### SOMNILA FLEX WL, Esquerda

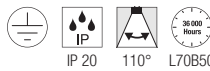

100-240V ~50/60Hz | 12V  
Material: alumínio

- 1 Ligação USB; 5VDC 2A máx.
- Fontes de luz com interruptores individuais.



Down 120lm | 3000K



Casquilho: 1xE27 Máx. C: 18 cm

Variante	Art. n.º	EUR
○ Branco	1003459	242,00

### SOMNILA FLEX WL, Direita

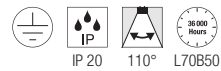

100-240V ~50/60Hz | 12V  
Material: alumínio

- 1 Ligação USB; 5VDC 2A máx.
- Fontes de luz com interruptores individuais.



Down 120lm | 3000K



Casquilho: 1xE27 Máx. C: 18 cm

Variante	Art. n.º	EUR
○ Branco	1003460	242,00



1002608 387

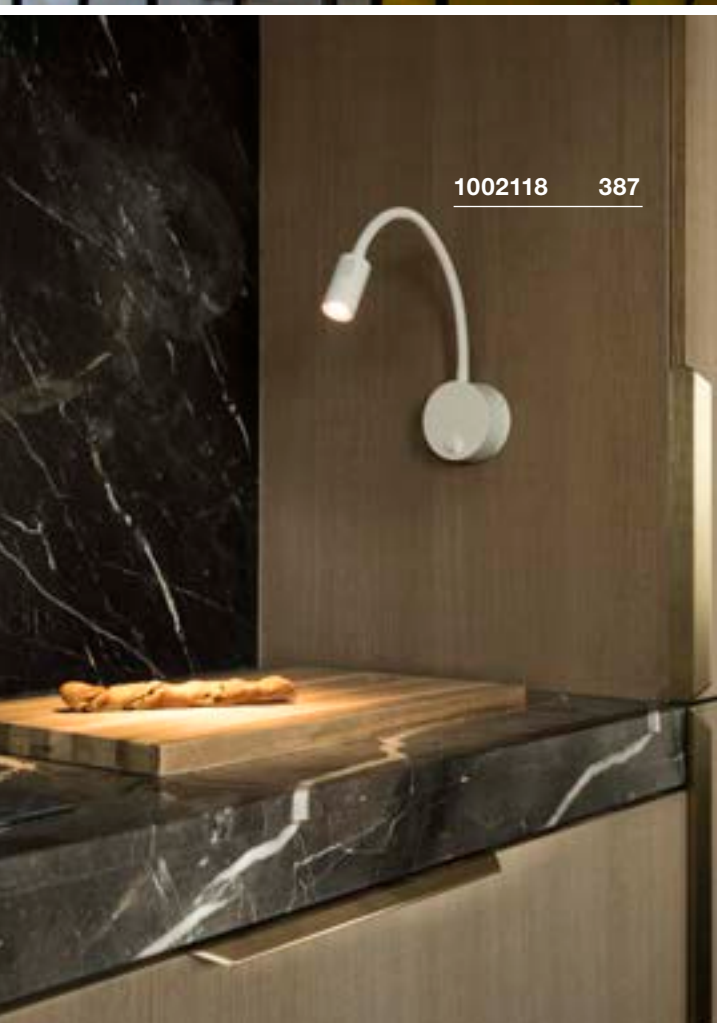

1002118 387

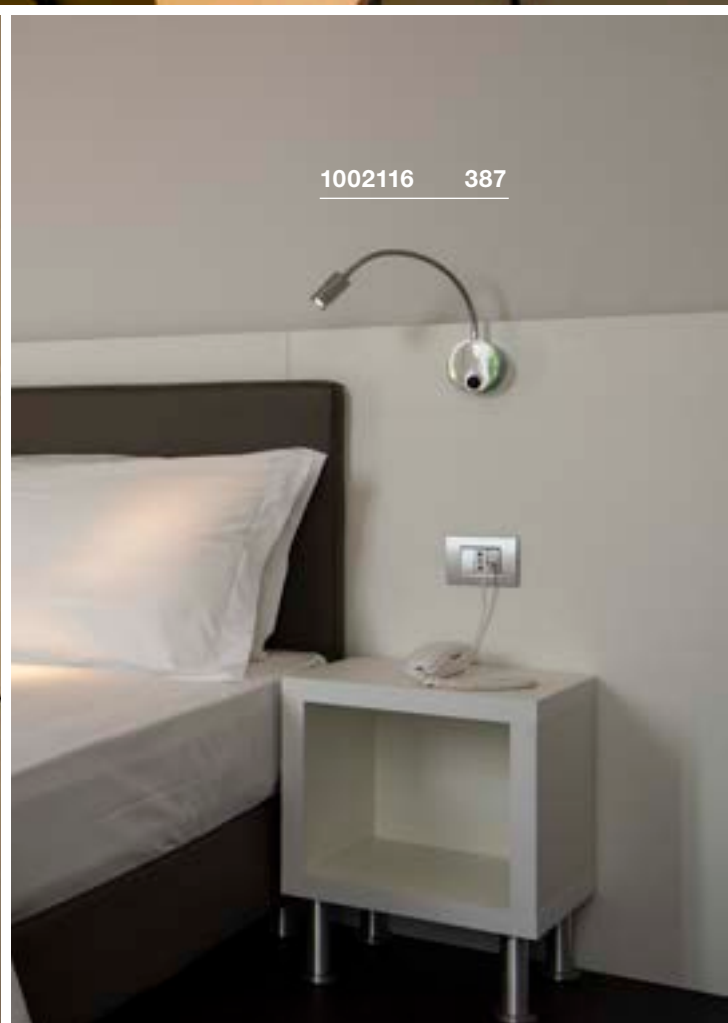

1002116 387



### DIO FLEX PLATE WL QPAR51

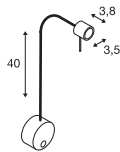

220-240V ~50/60Hz  
Material: alumínio

- Interruptor no corpo da luminária
- Não inclui anel decorativo (Artigo nº 151040)



Base: 1xGU10

Variante	Art. n.º	EUR
● Preto	1002608	57,00
○ Branco	1002607	57,00
● Cromado	146692	66,00



LED GU10 51mm | 6W | 38°  
2700K | 450lm | EE=F  
6kWh/1000h



Art. N.º: 1005077 | 7,50 EUR

### DIO FLEX PLATE WL

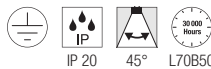
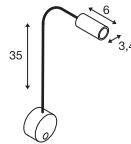

100-240V ~50/60Hz | 350mA  
Potência total: 1,9W  
Material: alumínio/vidro

- Interruptor no corpo da luminária



Down

100lm

2700K  
3000K  
4000K

Variante	Art. n.º	EUR
● Preto		
2700K	1002430	100,00
○ Branco		
2700K	1002117	100,00
● Preto		
3000K	1002431	100,00
○ Branco		
3000K	1002118	100,00
● Preto		
4000K	1002432	100,00
○ Branco		
4000K	1002119	100,00

### DIO FLEX PLATE WL

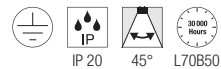
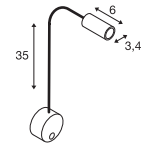

100-240V ~50/60Hz | 350mA  
Potência total: 1,9W  
Material: alumínio/vidro

- Interruptor no corpo da luminária



Down

100lm

2700K  
3000K

Variante	Art. n.º	EUR
● Cromado		
2700K	1002116	106,00
● Cromado		
3000K	146682	106,00

PHELIA  
WL, QPAR51

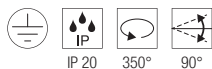
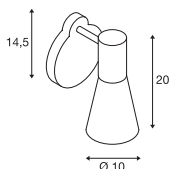

220-240V ~50/60Hz  
Material: alumínio/aço

- Interruptor na cabeça da luminária



Casquilho: 1xGU10 Máx. Ø: 5,1 cm C: 10,5 cm

Variante	Art. n.º	EUR
● Preto	148540	131,00



LED GU10 51mm | 6W | 38°  
2700K | 450lm | EE=F  
6kWh/1000h



Art. N.º: 1005077 | 7,50 EUR

MERADO FLOOD  
WL, PHASE

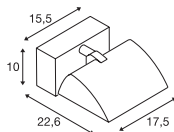

220-240V ~50/60Hz | 1000mA  
Potência total: 40W  
Material: alumínio



Down 3000lm | 3000K  
3200lm | 4000K

Variante	Art. n.º	EUR
○ Branco 3000lm   3000K	1001468	247,00
○ Branco 3200lm   4000K	1001472	247,00



148540 388



1001468 388



DISPLAY ADL 50  
QPAR51

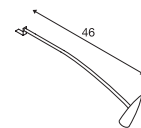

1002860 389



220-240V ~50/60Hz  
Material: alumínio/bronze

- Extremidade do cabo aberta
- Inclui caixa de ligação

**SOCKET INSIDE** <50 W

Casquilho: 1xGU10

Variante	Art. n.º	EUR
○ Branco	1002860	48,25
● Cromado	146332	62,00



LED GU10 51mm | 6W | 36°  
2200-2700K | 360lm | EE=G  
6kWh/1000h



Art. N.º: 1005273 | 9,99 EUR



Encontre a família NUMINOS® nas páginas 98–101

LED

NEW



Encontre a família MEDO® nas páginas 148–163

LED



Encontre a família ONE® nas páginas 192–193

LED

NEW



**SCKET**  
PANTILO ROPE 19 | 393

NEW



**SCKET**  
PANTILO ROPE 27 | 393

NEW



LED  
CYFT | 395

NEW



**SCKET**  
ASTO TUBE | 395

NEW



**SCKET**  
ASTO TUBE | 397

NEW



**SCKET**  
ASTO TUBE | 397

NEW



**SCKET**  
ASTO TUBE | 399

NEW



**SCKET**  
ASTO TUBE | 397



LED  
OCULUS | 399



LED  
KARPO 30 | 399



LED  
NOBLO® | 401



LED  
NOBLO® | 401



LED  
NOBLO® | 401



LED  
KALU | 403



LED  
KALU | 403



LED  
KALU | 403



LED  
KALU | 403



**SCKET**  
KALU | 405



**SCKET**  
KALU | 405



**SCKET**  
KALU | 405



**SCKET**  
KALU | 405



**SCKET**  
ENOLA B | 407



**SCKET**  
ENOLA B | 407



**SCKET**  
ENOLA B | 407



**SCKET**  
ALTRA DICE | 408



**SCKET**  
SPOT 79 | 409



**SCKET**  
INDA | 409



**SCKET**  
PURI | 411



**SCKET**  
PURI | 411



**SCKET**  
PURI | 411



**SCKET**  
PURI | 411



**SCKET**  
AVO | 413



**SCKET**  
AVO | 413



**SCKET**  
AVO | 413



**SCKET**  
AVO | 413



**SCKET**  
AVO | 415



**SCKET**  
ASTO | 415



**SCKET**  
ASTO | 415



**SCKET**  
ASTO | 415



**LED**  
SENSER 12 | 417



**LED**  
SENSER 18 | 417



**LED**  
SENSER 24 | 417



**LED**  
SENSER 12 | 419



**LED**  
SENSER 18 | 419



**LED**  
SENSER 24 | 419



**LED**  
SIMA | 420



**LED**  
SIMA | 420



**LED**  
SIMA | 421

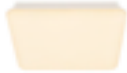

**LED**  
SIMA | 421



**LED**  
LIPSY® 30 | 423



**LED**  
LIPSY® 40 | 423



**LED**  
LIPSY® 50 | 423



**LED**  
LIPSY® 30 | 425



**LED**  
LIPSY® 40 | 425



**LED**  
LIPSY® 50 | 425



**LED**  
LIPSY® 40 | 426



**LED**  
LIPSY® 50 | 426



**SCKET**  
MELAN | 427



**SCKET**  
GLASSA | 427



**LED**  
BATTEN 60 | 429



**LED**  
BATTEN 120 | 429



**LED**  
LONG GRILL | 430



**LED**  
SIGHT 60 | 431



**LED**  
SIGHT 115 | 431



**LED**  
BENA 120 | 433



**LED**  
BENA 150 | 433



1007591 393

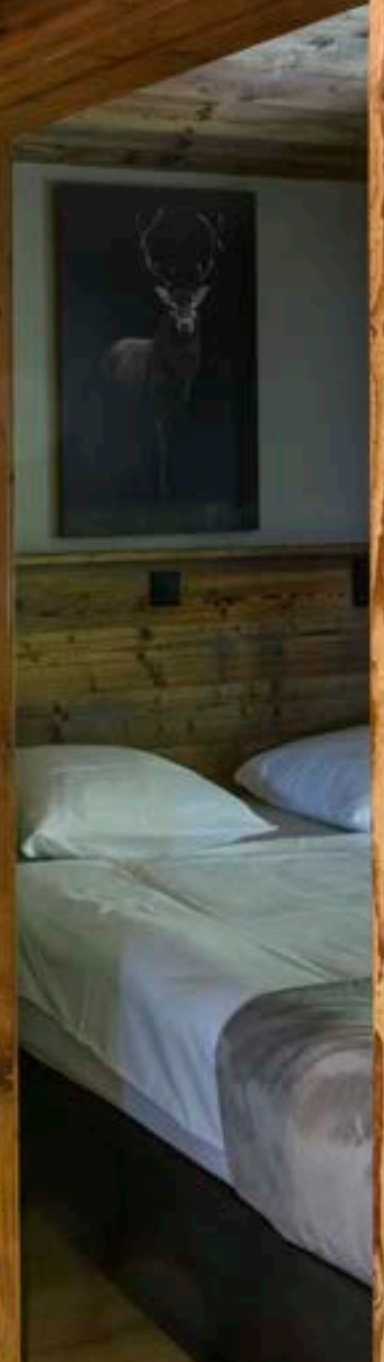





### PANTILHO ROPE 19 CW, E27

### PANTILHO ROPE 27 CW, E27

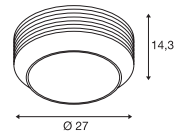
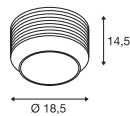

200-240V ~50/60Hz  
Material: vidro / aço / cânhamo

200-240V ~50/60Hz  
Material: vidro / aço / cânhamo



Casquilho: 1xE27 Máx. Ø: 10 cm | C: 11 cm

Casquilho: 1xE27 Máx. Ø: 15 cm | C: 11 cm

Variante	Art. n.º	EUR
● Âmbar / dourado	1007592	159,00
● Antracite / prata	1007593	159,00

Variante	Art. n.º	EUR
● Âmbar / dourado	1007591	199,00
● Antracite / prata	1007590	199,00



A60 | 7,5W | 180°  
2700K | 720lm | EE=F  
8kWh/1000h



Art. N.º: 1005305 | 19,00 EUR



A60 | 7,5W | 180°  
2700K | 720lm | EE=F  
8kWh/1000h



Art. N.º: 1005305 | 19,00 EUR

1006439 395





### CYFT CW



NEW

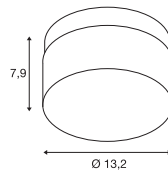

220-240V ~50/60Hz | 500mA  
Potência total: 6,5W  
Material: alumínio



330lm | 2700K | 350lm | 3000K | 380lm | 4000K

Variante	Art. n.º	EUR
● Preto	1007608	199,00

### CYFT Anel decorativo



NEW

A: 2,45 cm  
Ø: 13,10 cm  
Material: aço

Variante	Art. n.º	EUR
○ Branco	1007611	18,00
● Bronze	1007610	29,90
● Cromado	1007609	25,00

### ASTO TUBE CL, single, GU10



NEW

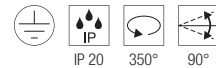
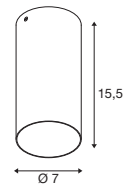

220-240V ~50/60Hz  
Material: alumínio



Casquilho: 1xGU10

Variante	Art. n.º	EUR
● Preto	1006439	50,00
○ Branco	1006440	50,00

### ASTO TUBE Refletor decorativo



NEW

A: 3,95 cm  
Ø: 6,75 cm  
Material: policarbonato (PC)

Variante	Art. n.º	EUR
● Cromado preto	1007190	4,00
● Dourado	1006450	4,00
● Cromado	1006449	4,00
● Cobre	1006451	4,00

1006423 397

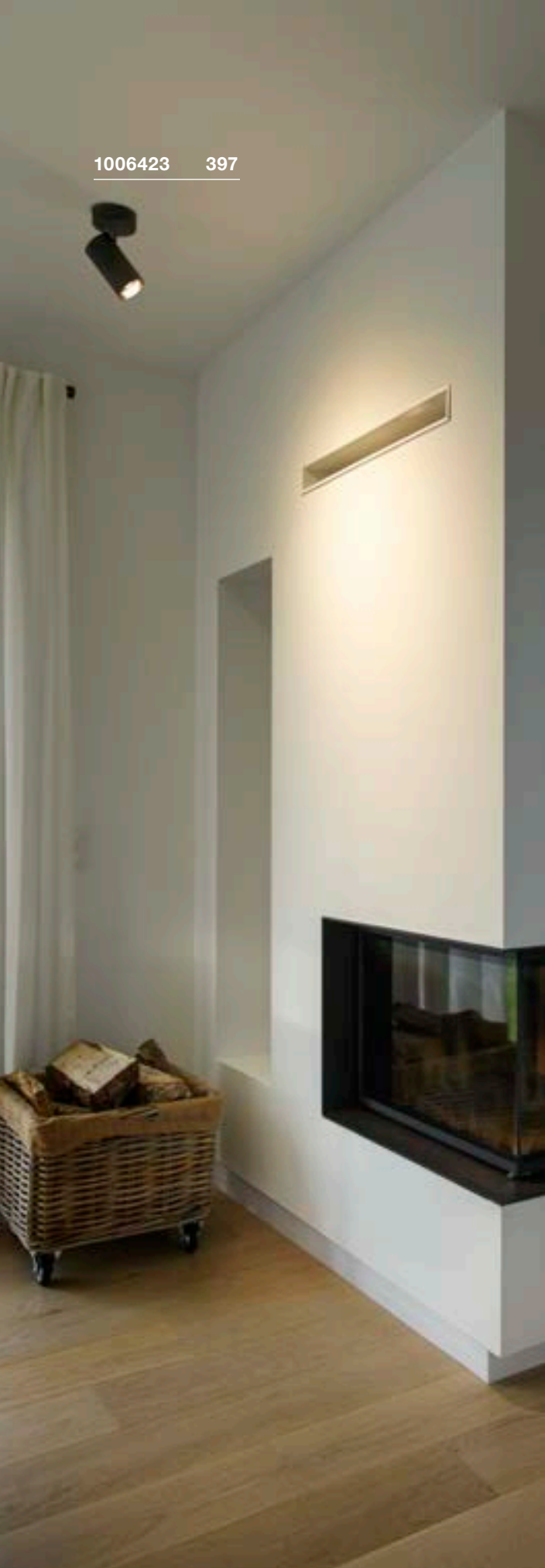

1006428 397

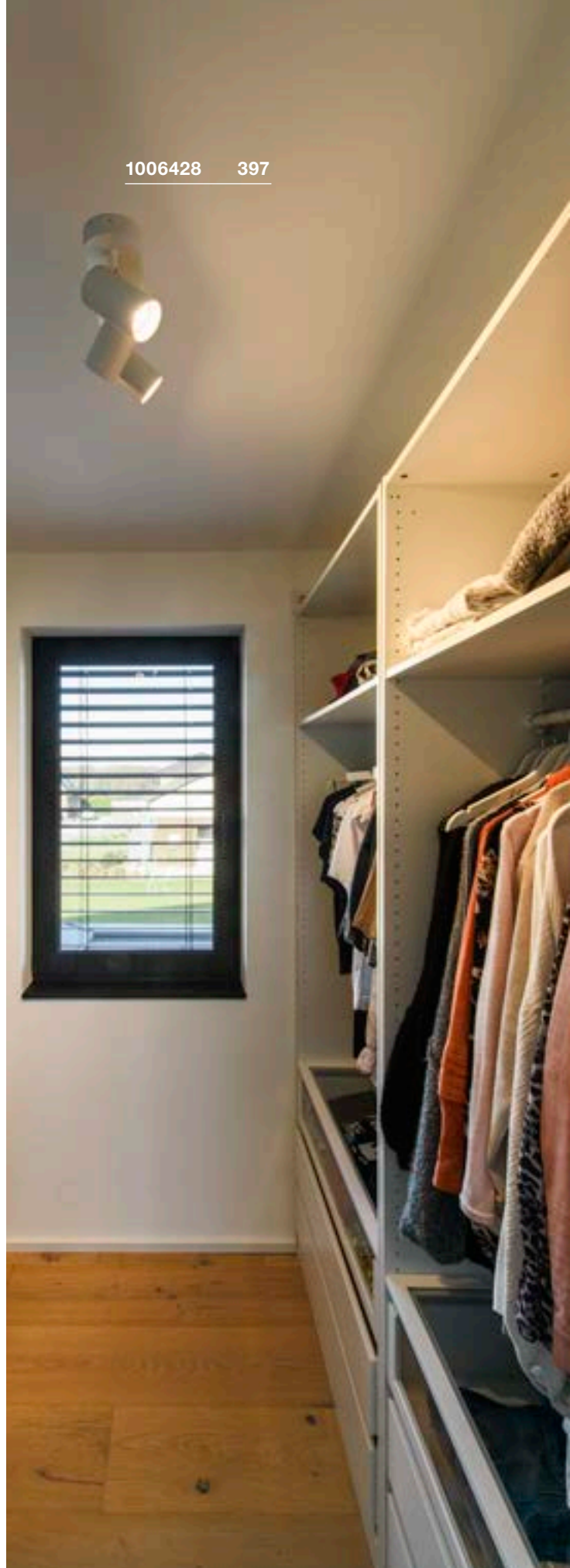



## ASTO TUBE

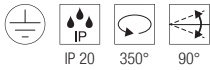

220-240V ~50/60Hz  
Material: alumínio



Casquilho: 2xGU10



LED GU10 | 6W | 38°  
2700K | 450lm | EE=F  
6kWh/1000h



Art. N.º: 1005076 | 7,50 EUR

## ASTO TUBE CW, single, GU10

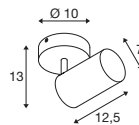

## ASTO TUBE CW, double, GU10

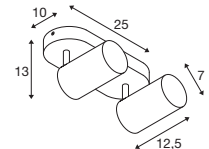

Variante	Art. n.º	EUR
● Preto	1006423	50,00
○ Branco	1006424	50,00

Variante	Art. n.º	EUR
● Preto	1006425	95,00
○ Branco	1006426	95,00

## ASTO TUBE Refletor decorativo



A: 3,95 cm  
Ø: 6,75 cm  
Material: policarbonato (PC)

## ASTO TUBE CW, triple, GU10

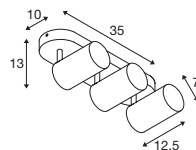

## ASTO TUBE CW, quadruple, GU10

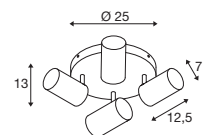

Variante	Art. n.º	EUR
● Cromado preto	1007190	4,00
● Dourado	1006450	4,00
● Cromado	1006449	4,00
● Cobre	1006451	4,00

Variante	Art. n.º	EUR
● Preto	1006427	135,00
○ Branco	1006428	135,00

Variante	Art. n.º	EUR
● Preto	1006429	165,00
○ Branco	1006430	165,00



1004664 399

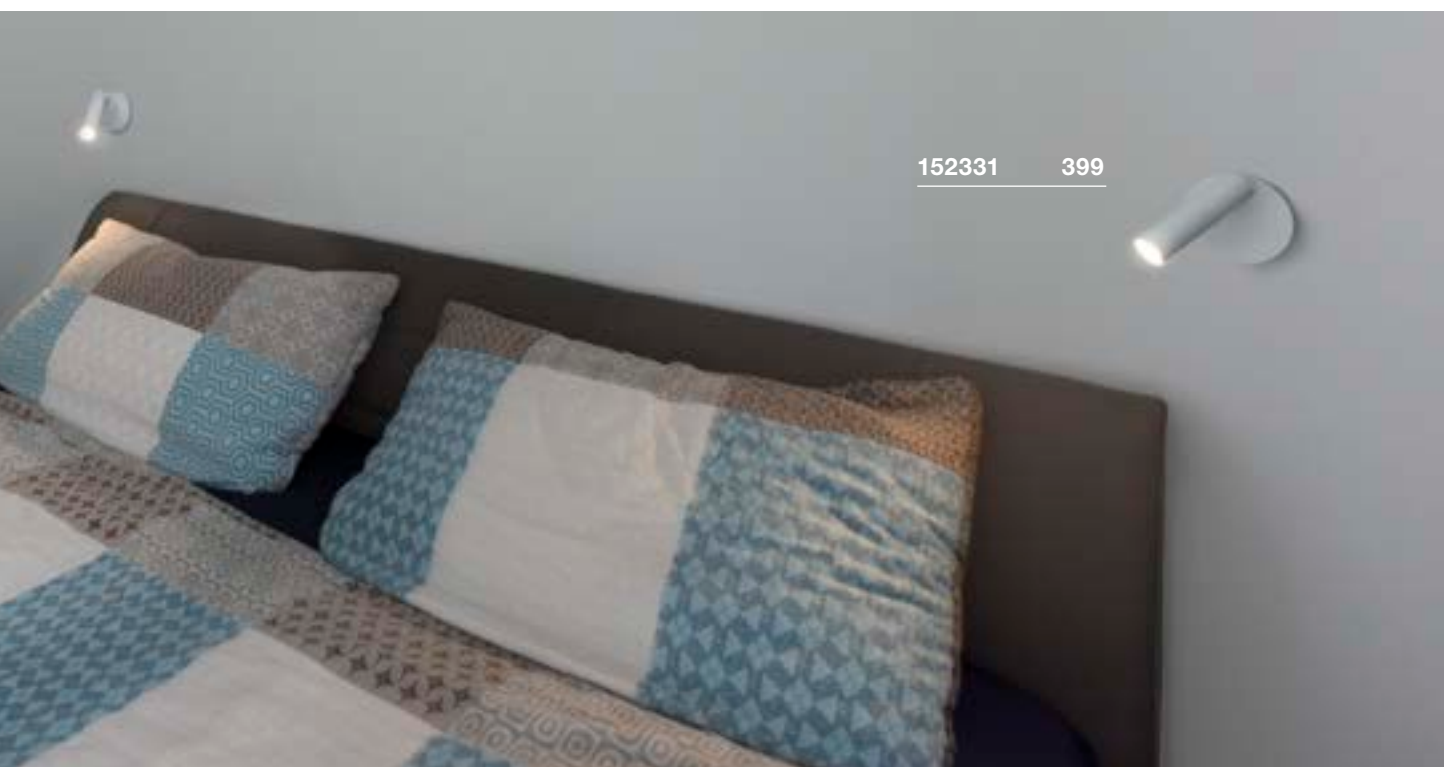

152331 399



### OCULUS CW, PHASE

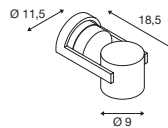

220-240V ~50/60Hz | 250mA  
Potência total: 11W  
Material: alumínio/vidro

- Inclui lente fosca adicional



Down 36lm | 2000K - 780lm | 3000K

Variante	Art. n.º	EUR
● Preto	1004664	255,00
○ Branco	1004665	255,00

### KARPO 30 CW, single

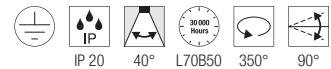
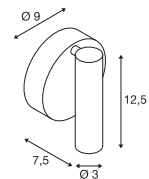

220-240V ~50/60Hz | 500mA  
Potência total: 9,3W  
Material: alumínio/aço



Down 560lm | 680lm | 3000K

Variante	Art. n.º	EUR
● Preto	152330	129,00
○ Branco	152331	129,00



1002974 401







## NOBLO®

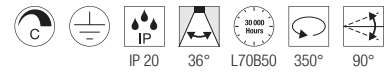

220-240V ~50/60Hz | 350mA  
 Potência total: 8W  
 Material: alumínio



Down 620lm | 2700K  
1240lm  
1860lm

### NOBLO® CW, single, PHASE

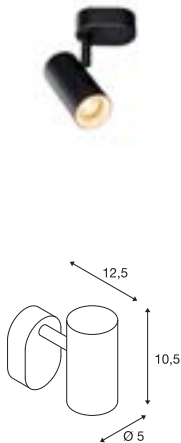

Variante	Art. n.º	EUR
● Preto		
620lm   2700K   8W	<b>1002969</b>	<b>105,00</b>
○ Branco		
620lm   2700K   8W	<b>1002970</b>	<b>105,00</b>
● Prateado		
620lm   2700K   8W	<b>1002971</b>	<b>105,00</b>

### NOBLO® CW, double, PHASE

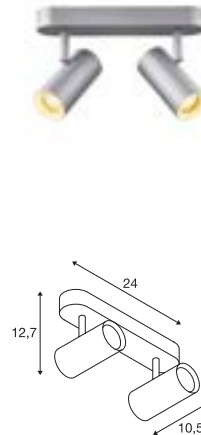

Variante	Art. n.º	EUR
● Preto		
1240lm   2700K   8W	<b>1002973</b>	<b>169,00</b>
○ Branco		
1240lm   2700K   8W	<b>1002974</b>	<b>169,00</b>
● Prateado		
1240lm   2700K   8W	<b>1002975</b>	<b>169,00</b>

### NOBLO® CW, triple, PHASE

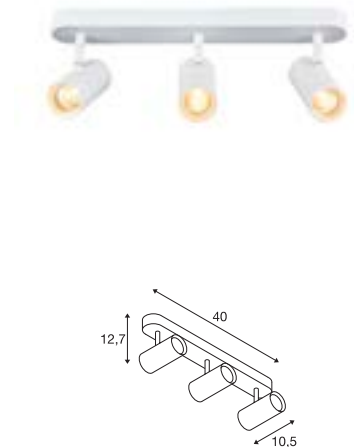

Variante	Art. n.º	EUR
● Preto		
1860lm   2700K   8W	<b>1002976</b>	<b>251,00</b>
○ Branco		
1860lm   2700K   8W	<b>1002977</b>	<b>251,00</b>
● Prateado		
1860lm   2700K   8W	<b>1002978</b>	<b>251,00</b>

1000131 403





# KALU

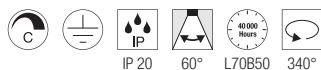

220-240V ~50/60Hz | 350mA  
 Potência total: 17W  
 Material: alumínio / policarbonato (PC)



Down

1000lm | 2000lm | 3000lm | 4000lm | 3000K

## KALU CW, single, PHASE

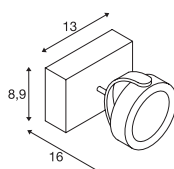

Variante	Art. n.º	EUR
● Preto 1000lm   3000K   17W	<b>1000127</b>	<b>159,00</b>
○ Branco 1000lm   3000K   17W	<b>1000128</b>	<b>159,00</b>

## KALU CW, double, PHASE

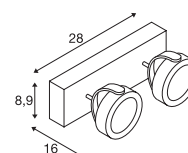

Variante	Art. n.º	EUR
● Preto 2000lm   3000K   17W	<b>1000129</b>	<b>262,00</b>
○ Branco 2000lm   3000K   17W	<b>1000130</b>	<b>262,00</b>

## KALU CW, triple, PHASE

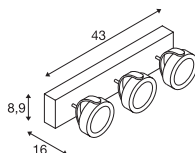

Variante	Art. n.º	EUR
● Preto 3000lm   3000K   17W	<b>1000131</b>	<b>398,00</b>
○ Branco 3000lm   3000K   17W	<b>1000132</b>	<b>398,00</b>

## KALU CW, quad, PHASE

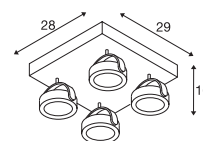

Variante	Art. n.º	EUR
● Preto 4000lm   3000K   17W	<b>1000135</b>	<b>494,00</b>
○ Branco 4000lm   3000K   17W	<b>1000136</b>	<b>494,00</b>

147321 405

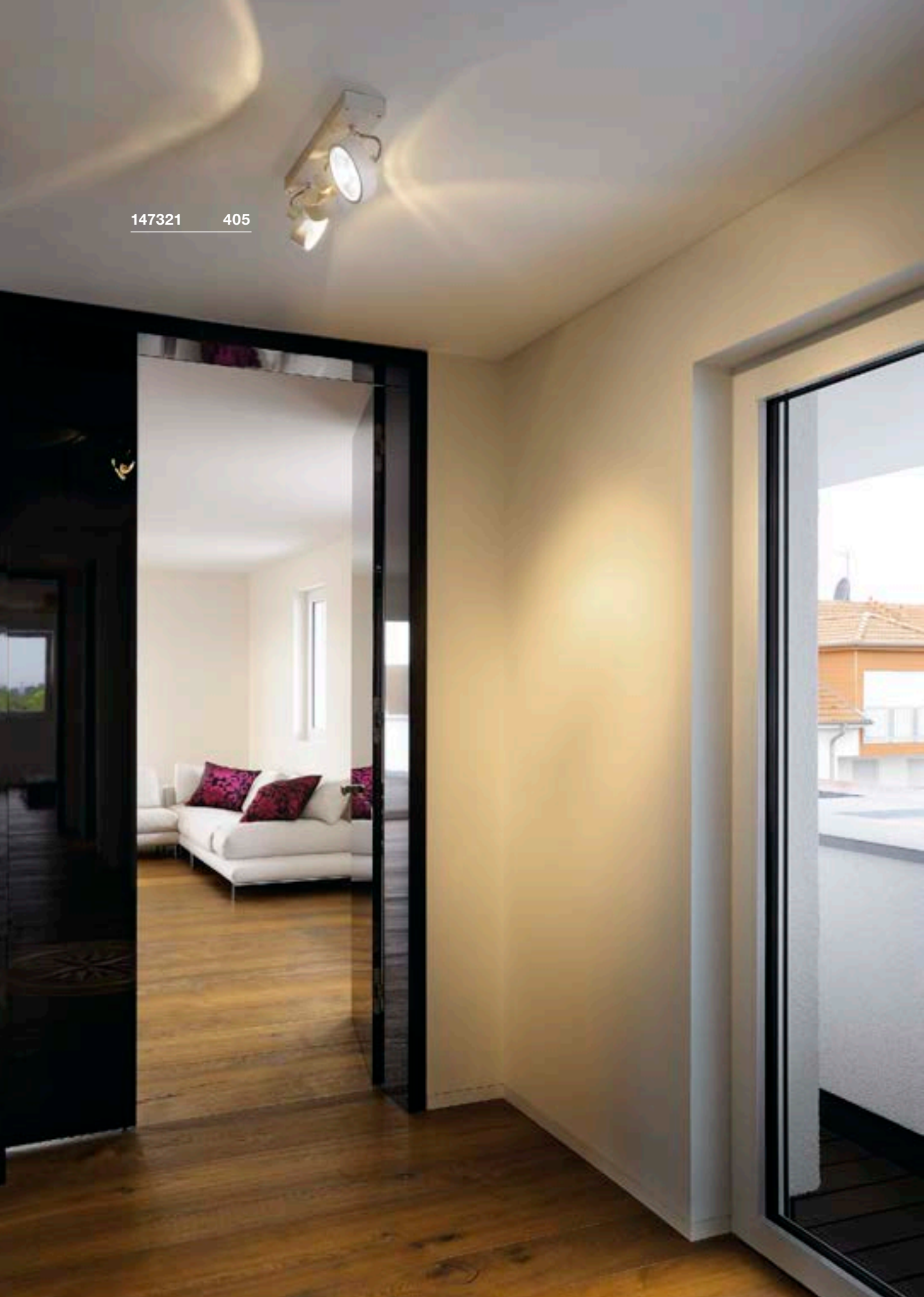



## KALU

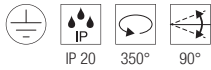

220-240V ~50/60Hz  
Material: alumínio



Casquilho: 1xGU10



QPAR111 | 8W | 38°  
2700K | 680lm | EE=F  
8kWh/1000h



Art. N.º: 1005274 | 30,75 EUR

## KALU CW, single, QPAR111

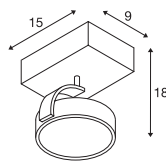

Variante	Art. n.º	EUR
● Preto	1000702	75,00
○ Branco	147301	75,00
● Alumínio	147306	78,00

## KALU CW, double, QPAR111

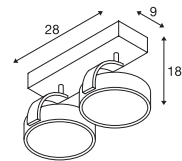

Variante	Art. n.º	EUR
● Preto	1000703	149,00
○ Branco	147311	149,00
● Alumínio	147316	159,00

## KALU CW, triple, QPAR111

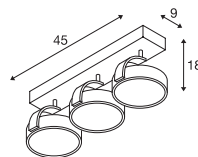

Variante	Art. n.º	EUR
● Preto	1000704	206,00
○ Branco	147321	206,00
● Alumínio	147326	217,00

## KALU CW, quad, QPAR111

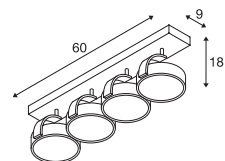

Variante	Art. n.º	EUR
● Preto	1002023	289,00
○ Branco	1002024	289,00
● Alumínio	1002025	299,00



152010 407



ENOLA B  
CW, single, QPAR51

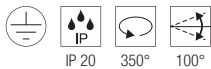
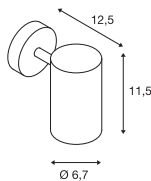

220-240V ~50/60Hz  
Material: alumínio/aço

- A versão branca inclui o anel decorativo
- Anel decorativo preto opcional disponível como acessório.



Casquilha: 1xGU10

Máx. C: 6,7 cm

Variante	Art. n.º	EUR
● Preto	152010	73,00
○ Branco	152011	73,00



LED GU10 51mm | 6W | 38°  
2700K | 450lm | EE=F  
6kWh/1000h



Art. N.º: 1005077 | 7,50 EUR



Artigo	Art. n.º	EUR
Anel decorativo		
● Preto	151840	8,95

ENOLA B  
CW, double, QPAR51

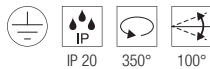
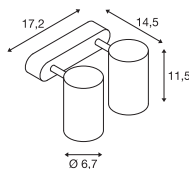

220-240V ~50/60Hz  
Material: alumínio/aço

- A versão branca inclui o anel decorativo
- Anel decorativo preto opcional disponível como acessório.



Casquilha: 2xGU10

Máx. C: 6,7 cm

Variante	Art. n.º	EUR
● Preto	152020	125,00
○ Branco	152021	125,00



LED GU10 51mm | 6W | 38°  
2700K | 450lm | EE=F  
6kWh/1000h



Art. N.º: 1005077 | 7,50 EUR



Artigo	Art. n.º	EUR
Anel decorativo		
● Preto	151840	8,95

ENOLA B  
CW, double, QPAR51

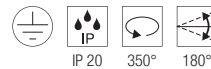
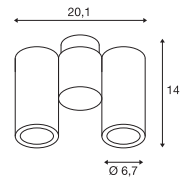

220-240V ~50/60Hz  
Material: alumínio/aço

- A versão branca inclui o anel decorativo
- Anel decorativo preto opcional disponível como acessório.



Casquilha: 2xGU10

Máx. C: 8 cm

Variante	Art. n.º	EUR
● Preto	151830	156,00
○ Branco	151831	156,00



LED GU10 51mm | 6W | 38°  
2700K | 450lm | EE=F  
6kWh/1000h



Art. N.º: 1005077 | 7,50 EUR



Artigo	Art. n.º	EUR
Anel decorativo		
● Preto	151840	8,95

1002215 408



## ALTRA DICE CW, double, QPAR51

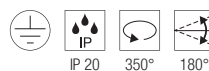
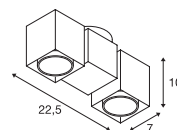

220-240V ~50/60Hz  
Material: alumínio/aço

**SECRET  
INSIDE** <50  
W

Casquilho: 2xGU10

Variante	Art. n.º	EUR
● Preto	1002215	109,00
○ Branco	151531	109,00
● Cinzento	151534	109,00



LED GU10 51mm | 6W | 36°  
2200-2700K | 360lm | EE=G  
6kWh/1000h



Art. N.º: 1005273 | 9,99 EUR





147551 409



**SPOT 79**  
CW, QPAR51

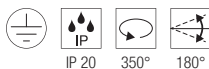
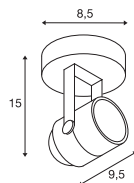

220-240V ~50/60Hz  
Material: alumínio

**SOCKET INSIDE** <50 W

Casquilho: 1xGU10 Máx. Ø: 5,1 cm C: 5,7 cm

Variante	Art. n.º	EUR
● Preto	132020	32,75
○ Branco	132021	32,75
● Cinzento	132024	32,75



LED GU10 51mm | 6W | 38°  
2700K | 450lm | EE=F  
6kWh/1000h

Art. N.º: 1005077 | 7,50 EUR



**INDA**  
CW, QPAR51

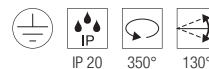
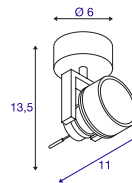

220-240V ~50/60Hz  
Material: alumínio

**SOCKET INSIDE** <50 W

Casquilho: 1xGU10 Máx. Ø: 5,1 cm C: 5,7 cm

Variante	Art. n.º	EUR
● Preto	147550	65,00
○ Branco	147551	65,00
● Alumínio	147559	69,00



LED GU10 51mm | 6W | 38°  
2700K | 450lm | EE=F  
6kWh/1000h

Art. N.º: 1005077 | 7,50 EUR







## PURI

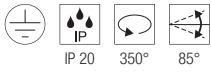

220-240V ~50/60Hz  
Material: alumínio/aço

- Inclui anel decorativo



Casquilho: GU10



LED GU10 51mm | 6W | 38°  
2700K | 450lm | EE=F  
6kWh/1000h



Art. N.º: 1005077 | 7,50 EUR

## PURI CW, single, QPAR51

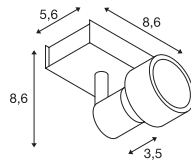

## PURI CW, double, QPAR51

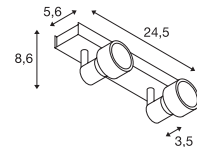

Variante	Art. n.º	EUR
● Preto	147360	39,00
○ Branco	147361	39,00

Variante	Art. n.º	EUR
● Preto	147370	79,00
○ Branco	147371	79,00

## PURI CW, triple, QPAR51

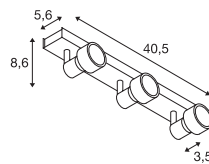

## PURI CW, quad, QPAR51

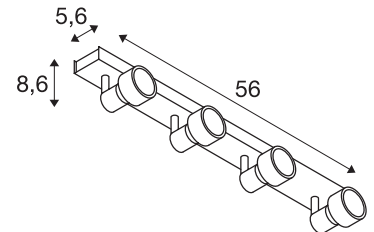

Variante	Art. n.º	EUR
● Preto	147380	109,00
○ Branco	147381	109,00

Variante	Art. n.º	EUR
● Preto	1002029	159,00
○ Branco	1002030	159,00

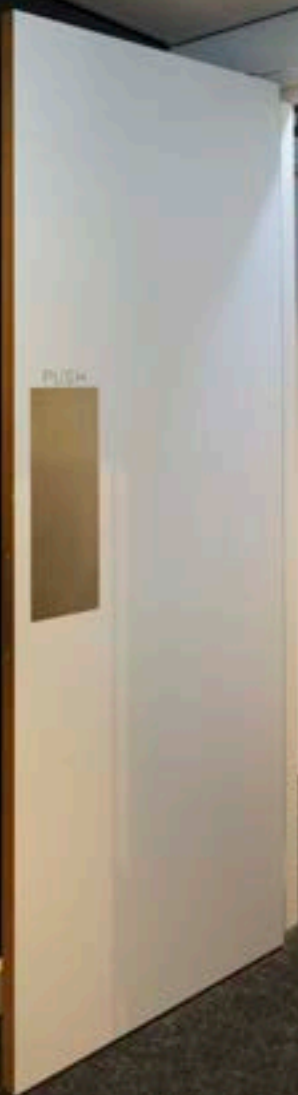



## AVO

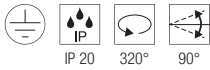

220-240V ~50/60Hz  
Material: aço



Casquilho: GU10



LED GU10 51mm | 6W | 38°  
2700K | 450lm | EE=F  
6kWh/1000h



Art. N.º: 1005077 | 7,50 EUR

## AVO CW, single, QPAR51

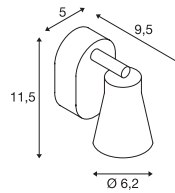

## AVO CW, double, QPAR51

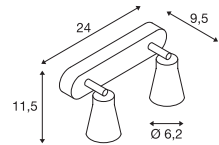

Variante	Art. n.º	EUR
● Preto	1000886	45,25
○ Branco	1000887	45,25

Variante	Art. n.º	EUR
● Preto	1000889	94,00
○ Branco	1000890	94,00

## AVO CW, triple, QPAR51

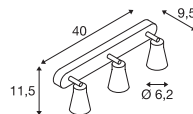

## AVO CW, quad, QPAR51

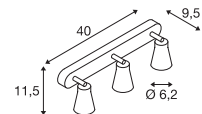

Variante	Art. n.º	EUR
● Preto	1000892	117,00
○ Branco	1000893	117,00

Variante	Art. n.º	EUR
● Preto	1000895	140,00
○ Branco	1000896	140,00



147443

415





## ASTO

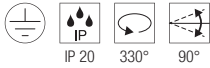

220-240V ~50/60Hz  
Material: alumínio



Casquilho: GU10



LED GU10 51mm | 6W | 38°  
2700K | 450lm | EE=F  
6kWh/1000h



Art. N.º: 1005075 | 7,50 EUR

## ASTO CW, single, QPAR51

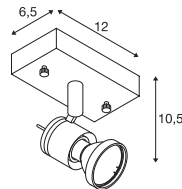

Variante	Art. n.º	EUR
● Alumínio	147441	35,75

## ASTO CW, double, QPAR51

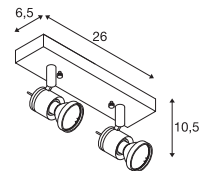

Variante	Art. n.º	EUR
● Alumínio	147442	70,00

## ASTO CW, triple, QPAR51

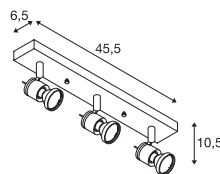

Variante	Art. n.º	EUR
● Alumínio	147443	95,00

## ASTO CW, quad, QPAR51

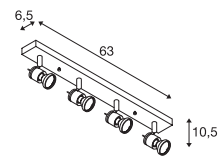

Variante	Art. n.º	EUR
● Alumínio	147444	119,00

1004705 417

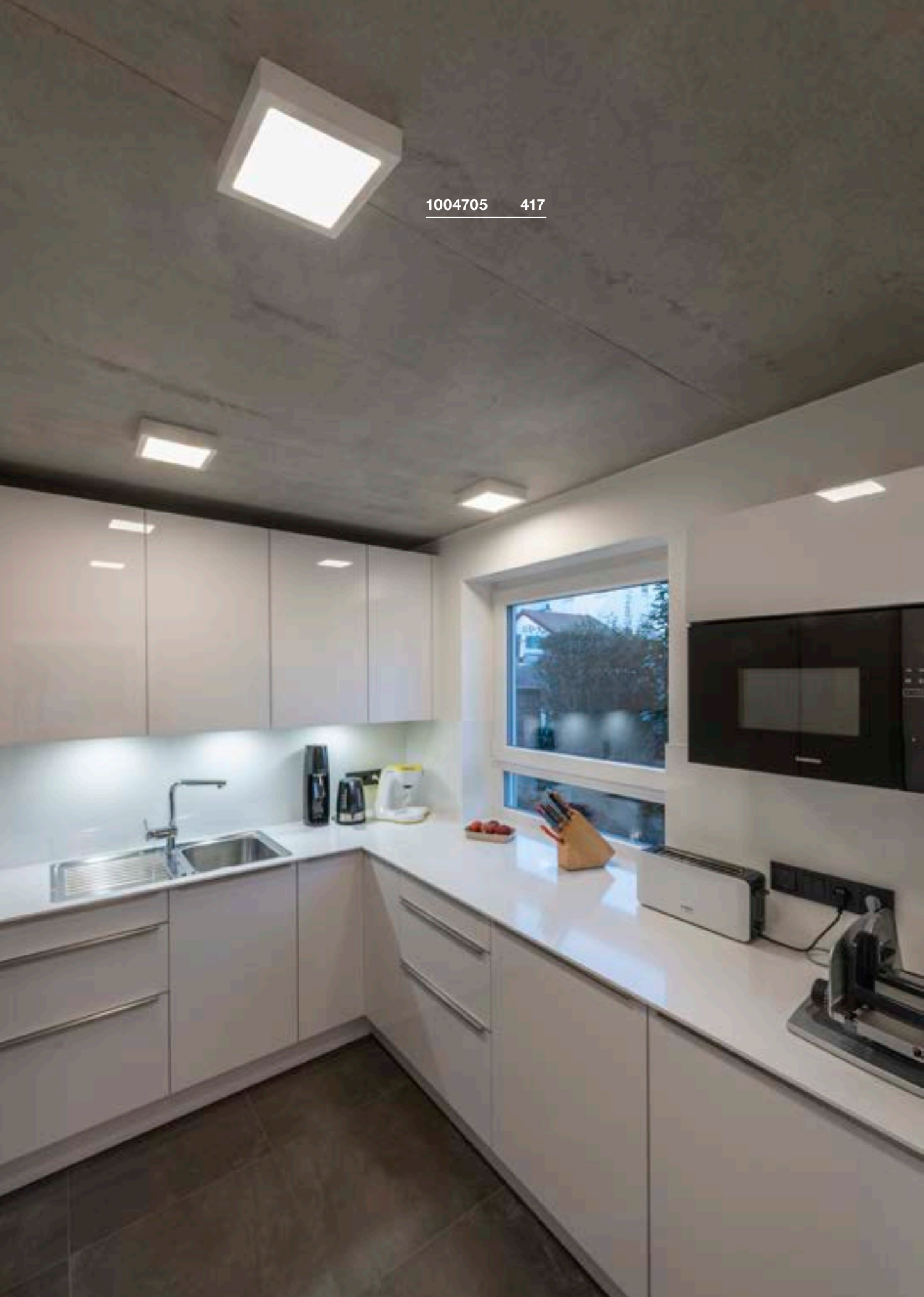





**SENSER 12**  
CW, quadrado, PHASE

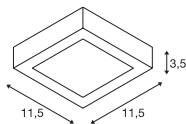

220-240V ~50/60Hz | 200mA  
Potência total: 8,4W  
Material: alumínio



Down 460lm | 3000K

Variante	Art. n.º	EUR
<input type="radio"/> Branco	1003017	74,00

**SENSER 18**  
CW, quadrado, PHASE

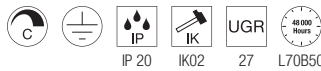
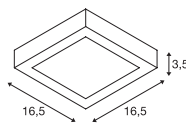

220-240V ~50/60Hz | 350mA  
Potência total: 13W  
Material: alumínio



Down 840lm | 3000K

Variante	Art. n.º	EUR
<input type="radio"/> Branco	1003018	79,00

**SENSER 24**  
CW, quadrado, PHASE

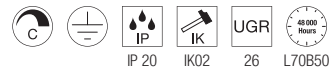
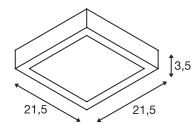

220-240V ~50/60Hz | 500mA  
Potência total: 15W  
Material: alumínio



Down 1140lm | 3000K  
1240lm | 4000K

Variante	Art. n.º	EUR
<input type="radio"/> Branco		
1140lm   3000K	1003019	85,00
<input type="radio"/> Branco		
1240lm   4000K	1004705	85,00





**SENSER 12**  
CW, Redondo, PHASE

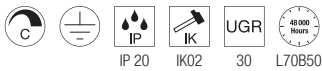
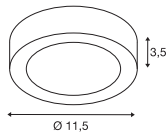

220-240V ~50/60Hz | 200mA  
Potência total: 8,4W  
Material: alumínio



Down 460lm | 3000K  
470lm | 4000K

Variante	Art. n.º	EUR
○ Branco 460lm   3000K   8,4W	<b>1003014</b>	<b>74,00</b>
○ Branco 470lm   4000K   8,2W	<b>1004700</b>	<b>74,00</b>

**SENSER 18**  
CW, Redondo, PHASE

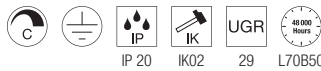
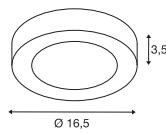

220-240V ~50/60Hz | 350mA  
Potência total: 13W  
Material: alumínio



Down 830lm | 3000K  
990lm | 4000K

Variante	Art. n.º	EUR
○ Branco 830lm   3000K   13W	<b>1003015</b>	<b>79,00</b>
○ Branco 990lm   4000K   12W	<b>1004701</b>	<b>79,00</b>

**SENSER 24**  
CW, Redondo, PHASE

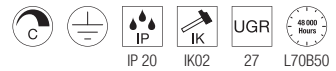
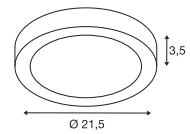

220-240V ~50/60Hz | 500mA  
Potência total: 15W  
Material: alumínio



Down 1140lm | 3000K  
1300lm | 4000K

Variante	Art. n.º	EUR
○ Branco 1140lm   3000K	<b>1003016</b>	<b>85,00</b>
○ Branco 1300lm   4000K	<b>1004702</b>	<b>85,00</b>

SIMA  
CW, Redondo, Sensor

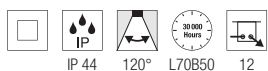
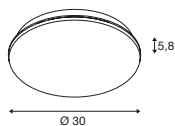

220-240V ~50/60Hz | 320mA  
Potência total: 24W  
Material: policarbonato (PC)



Down 2200lm | 3000K

Variante	Art. n.º	EUR
○ Branco	1005086	176,00

SIMA  
CW, Redondo, PHASE

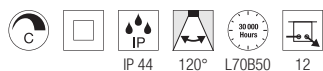
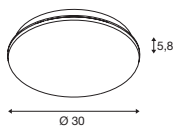

220-240V ~50/60Hz | 320mA  
Potência total: 24W  
Material: policarbonato (PC)



Down 2200lm | 3000K

Variante	Art. n.º	EUR
○ Branco	1005085	152,00

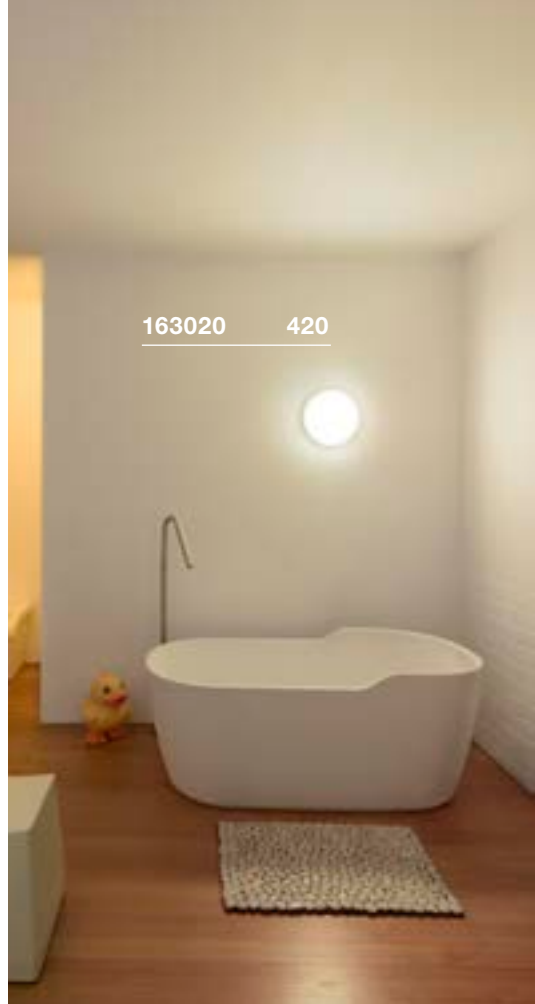

163020 420

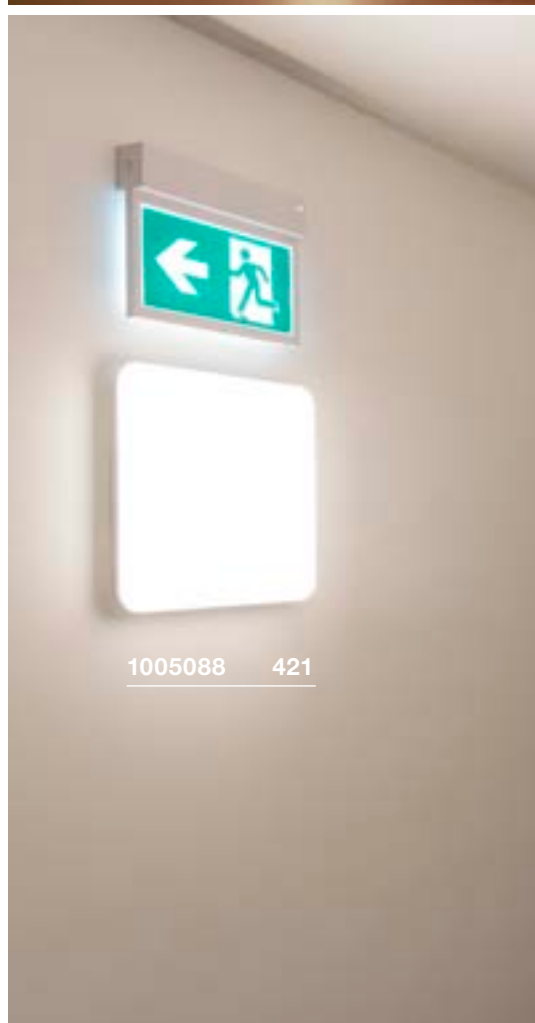

1005088 421

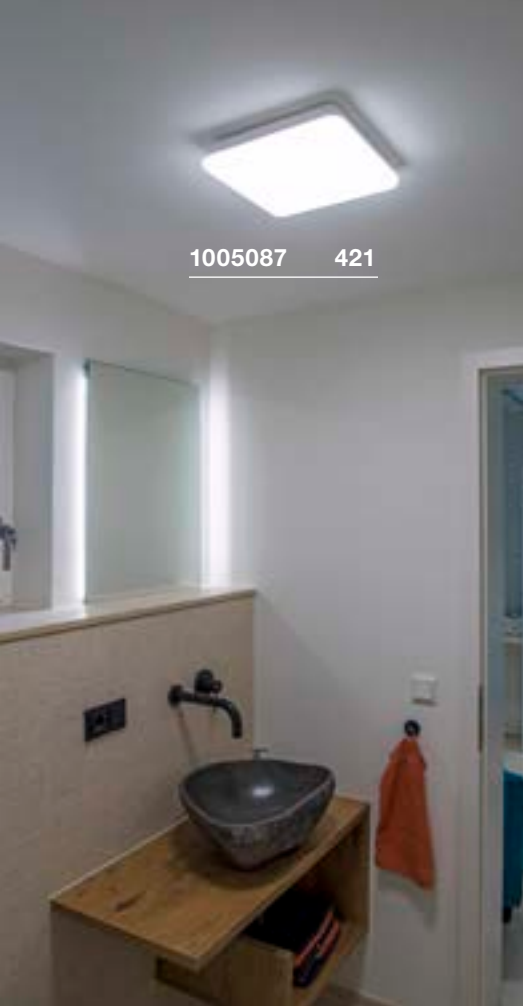

1005087 421

**SIMA**  
CW, quadrado, Sensor

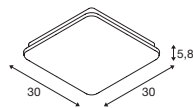

220-240V ~50/60Hz | 320mA  
Potência total: 24W  
Material: policarbonato (PC)



Down 2200lm | 3000K

Variante	Art. n.º	EUR
○ Branco	1005088	176,00

**SIMA**  
CW, quadrado, PHASE

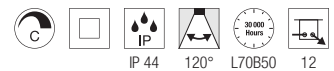
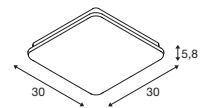

220-240V ~50/60Hz | 320mA  
Potência total: 24W  
Material: policarbonato (PC)



Down 2200lm | 3000K

Variante	Art. n.º	EUR
○ Branco	1005087	152,00



1002021 423





LIPSY® 30  
CW, Dome

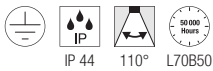
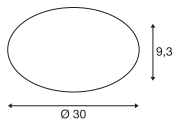
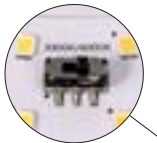

220-240V ~50/60Hz | 350mA  
Potência total: 13,5W  
Material: alumínio /policarbonato (PC)



Down 1550lm | 3000K | 1600lm | 4000K

Variante	Art. n.º	EUR
○ Branco	1002020	90,00

LIPSY® 40  
CW, Dome

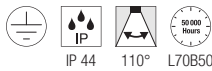
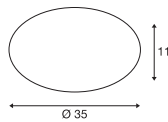
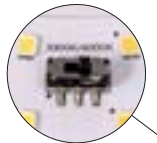

220-240V ~50/60Hz | 500mA  
Potência total: 17,5W  
Material: alumínio /policarbonato (PC)



Down 2050lm | 3000K | 2200lm | 4000K

Variante	Art. n.º	EUR
○ Branco	1002021	111,00

LIPSY® 50  
CW, Dome

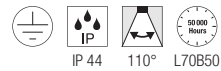
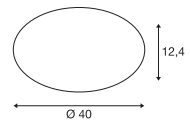

220-240V ~50/60Hz | 500mA  
Potência total: 20W  
Material: alumínio /policarbonato (PC)



Down 2500lm | 3000K | 2700lm | 4000K

Variante	Art. n.º	EUR
○ Branco	1002022	121,00

1002076 425







LIPSY® 30  
CW, Drum

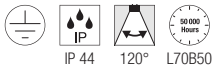
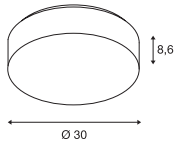
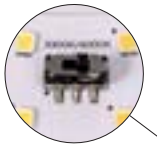

220-240V ~50/60Hz | 350mA  
Potência total: 13,5W  
Material: alumínio / policarbonato (PC)



Down 1600lm | 3000K | 1650lm | 4000K

Variante	Art. n.º	EUR
○ Branco	1002075	100,00

LIPSY® 40  
CW, Drum

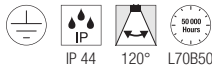
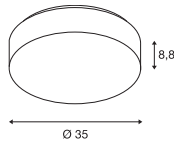
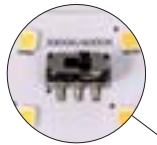

220-240V ~50/60Hz | 500mA  
Potência total: 17,5W  
Material: alumínio / policarbonato (PC)



Down 2100lm | 3000K | 2300lm | 4000K

Variante	Art. n.º	EUR
○ Branco	1002076	111,00

LIPSY® 50  
CW, Drum

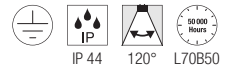
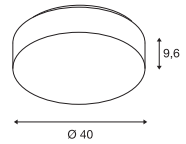
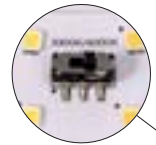

220-240V ~50/60Hz | 500mA  
Potência total: 20W  
Material: alumínio / policarbonato (PC)



Down 2450lm | 3000K | 2600lm | 4000K

Variante	Art. n.º	EUR
○ Branco	1002077	121,00



1002940 426



1002941 426

### LIPSY® 40

CW, Drum, DALI

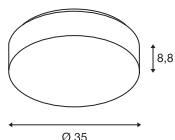
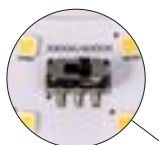

### LIPSY® 50

CW, Drum, DALI

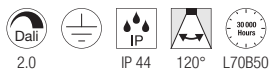
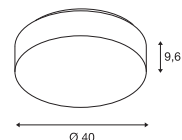
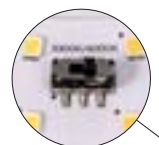

220-240V ~50/60Hz | 500mA  
 Potência total: 18W  
 Material: alumínio / policarbonato (PC)



Down 2100lm | 3000K | 2300lm | 4000K

Variante	Art. n.º	EUR
○ Branco	1002940	201,00



220-240V ~50/60Hz | 500mA  
 Potência total: 21W  
 Material: alumínio / policarbonato (PC)



Down 2450lm | 3000K | 2600lm | 4000K

Variante	Art. n.º	EUR
○ Branco	1002941	212,00



155236 427

MELAN  
CW, E27

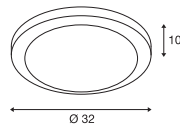

GLASSA  
CW, quadrado, E27

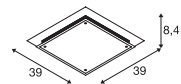

155180 427



220-240V ~50/60Hz  
Material: alumínio/vidro



Casquilho: 1xE27 Máx. Ø: 7 cm C: 16 cm

Variante	Art. n.º	EUR
● Alumínio	155236	122,00



A60 | 7,5W | 320°  
2700K | 800lm | EE=F  
8kWh/1000h



Art. N.º: 1005303 | 9,60 EUR



220-240V ~50/60Hz  
Material: aço/vidro



Casquilho: 2xE27 Máx. Ø: 4,8 cm C: 14,8 cm

Variante	Art. n.º	EUR
○ Transparente / cromado	155180	137,00



LED E27 | 8W | 240°  
4000K | 920lm | EE=E  
8kWh/1000h



Art. N.º: 1005290 | 10,25 EUR

1006124 429





### BATTEN 60 CW

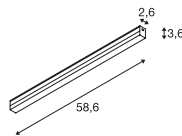

220-240V ~50/60Hz | 110mA  
Potência total: 9W  
Material: policarbonato (PC)

- Interruptor no corpo da luminária
- Cabo de alimentação não incluído



Down 940lm | 3000K | 980lm | 4000K

Variante	Art. n.º	EUR
○ Branco	1006123	53,00



Artigo	Art. n.º	EUR
União		
○ Branco	1006128	2,40
Cabo de alimentação		
○ Branco	1006125	10,40
Acessórios de fixação		
○ Branco	1006126	2,00
União com cabo de 60 cm		
○ Branco	1006127	5,80

### BATTEN 120 CW

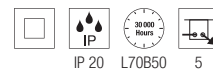
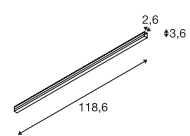

220-240V ~50/60Hz | 220mA  
Potência total: 18W  
Material: policarbonato (PC)

- Interruptor no corpo da luminária
- Cabo de alimentação não incluído



Down 1900lm | 3000K | 1960lm | 4000K

Variante	Art. n.º	EUR
○ Branco	1006124	66,00



Artigo	Art. n.º	EUR
União		
○ Branco	1006128	2,40
Cabo de alimentação		
○ Branco	1006125	10,40
Acessórios de fixação		
○ Branco	1006126	2,00
União com cabo de 60 cm		
○ Branco	1006127	5,80

# LONG GRILL CW

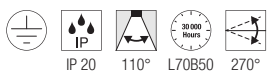
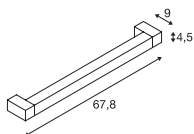

220-240V ~50/60Hz | 700mA  
Potência total: 20W  
Material: alumínio/acrílico



Down 1600lm | 3000K

Variante	Art. n.º	EUR
● Preto	1001020	297,00
○ Branco	1001019	297,00

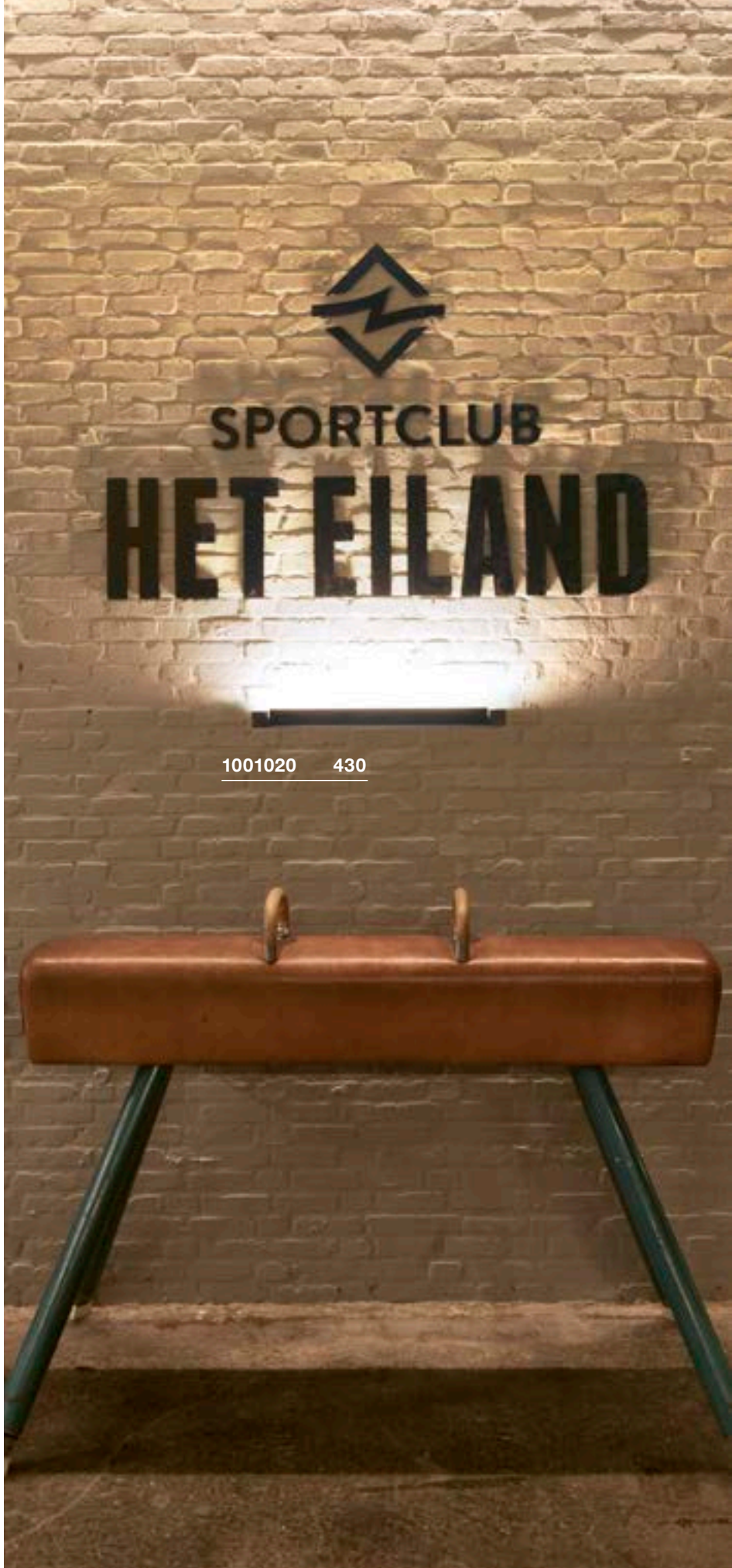

1001020 430



SIGHT 60  
CW

SIGHT 115  
CW

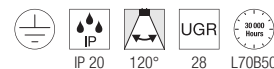
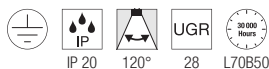
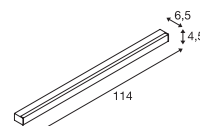
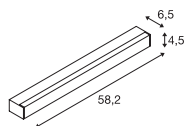
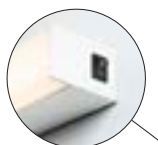

220-240V ~50/60Hz | 700mA  
Potência total: 20W  
Material: alumínio/acrílico

220-240V ~50/60Hz | 700mA  
Potência total: 38W  
Material: alumínio/acrílico

- Interruptor no corpo da luminária



Down 1490lm | 3000K



Down 3100lm | 3000K

Variante	Art. n.º	EUR
● Preto	1001283	232,00
○ Branco	1001284	232,00

Variante	Art. n.º	EUR
● Preto	1001286	323,00
○ Branco	1001287	323,00

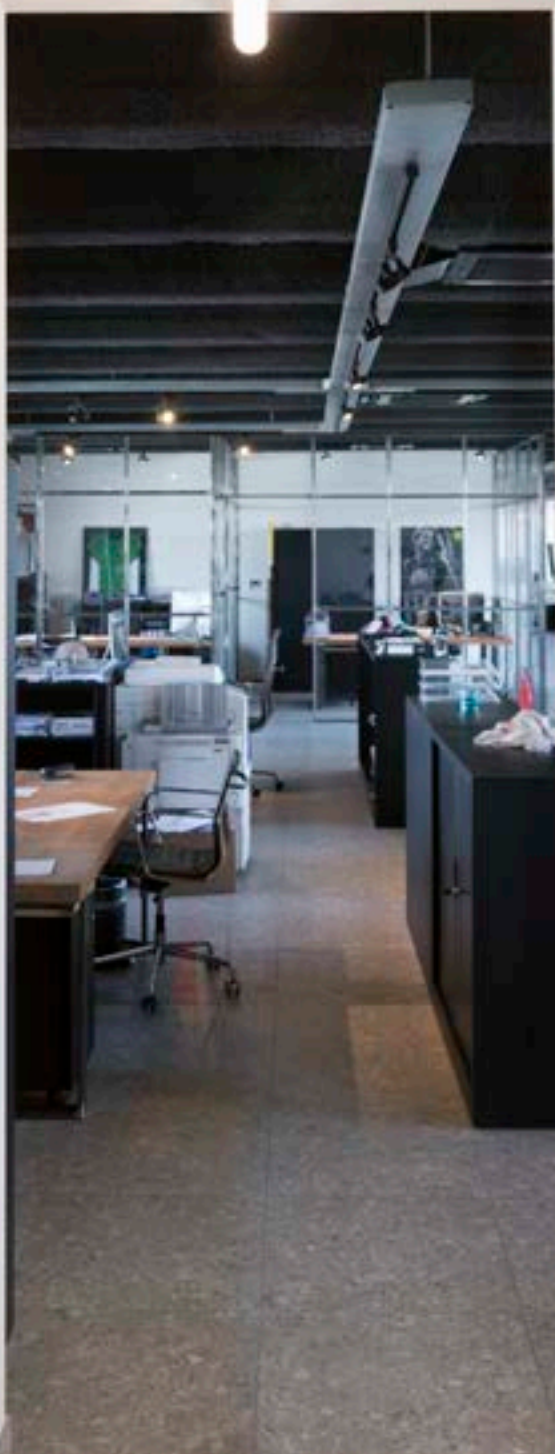





631337 433



BENA 120  
CW

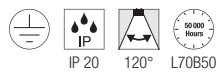
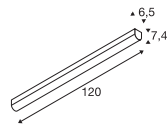

220-240V ~50/60Hz | 700mA  
Potência total: 28W  
Material: polimetilacrilato (PMMA)/aço



Down 3800lm | 3000K

Variante	Art. n.º	EUR
<input type="radio"/> Branco	631337	174,00

BENA 150  
CW

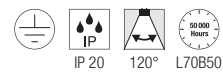
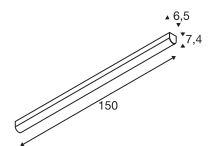

220-240V ~50/60Hz | 700mA  
Potência total: 36W  
Material: polimetilacrilato (PMMA)/aço



Down 5000lm | 3000K

Variante	Art. n.º	EUR
<input type="radio"/> Branco	631339	211,00



1007697 439





NEW

Encontre a família ONE® nas páginas 196-197

LED



NEW

LED

VINOLINA ONE | 437



NEW

LED

VINOLINA | 437



NEW

LED

VINOLINA TWO | 439



NEW

LED

TAHA | 441



NEW

SCKET

TINY SUN | 443



NEW

SCKET

LITTLE SUN | 443



NEW

SCKET

VARYT | 443



NEW

LED

WORKLIGHT PRO | 444



NEW

LED

WORKLIGHT PRO | 444



LED

WORKLIGHT | 445



LED

WORKLIGHT | 445



SCKET

FENDA | 447



SCKET

FENDA | 447



SCKET

FENDA | 447



SCKET

FENDA | 448



SCKET

FENDA BOW BASIS | 448



FENDA | 448



FENDA | 449



FENDA | 449



FENDA | 449



LED

KARPO | 452



LED

KARPO | 452



SCKET

PHELIA | 453



LED

TONILA | 453



LED

MAGANDA | 453



1007357 437

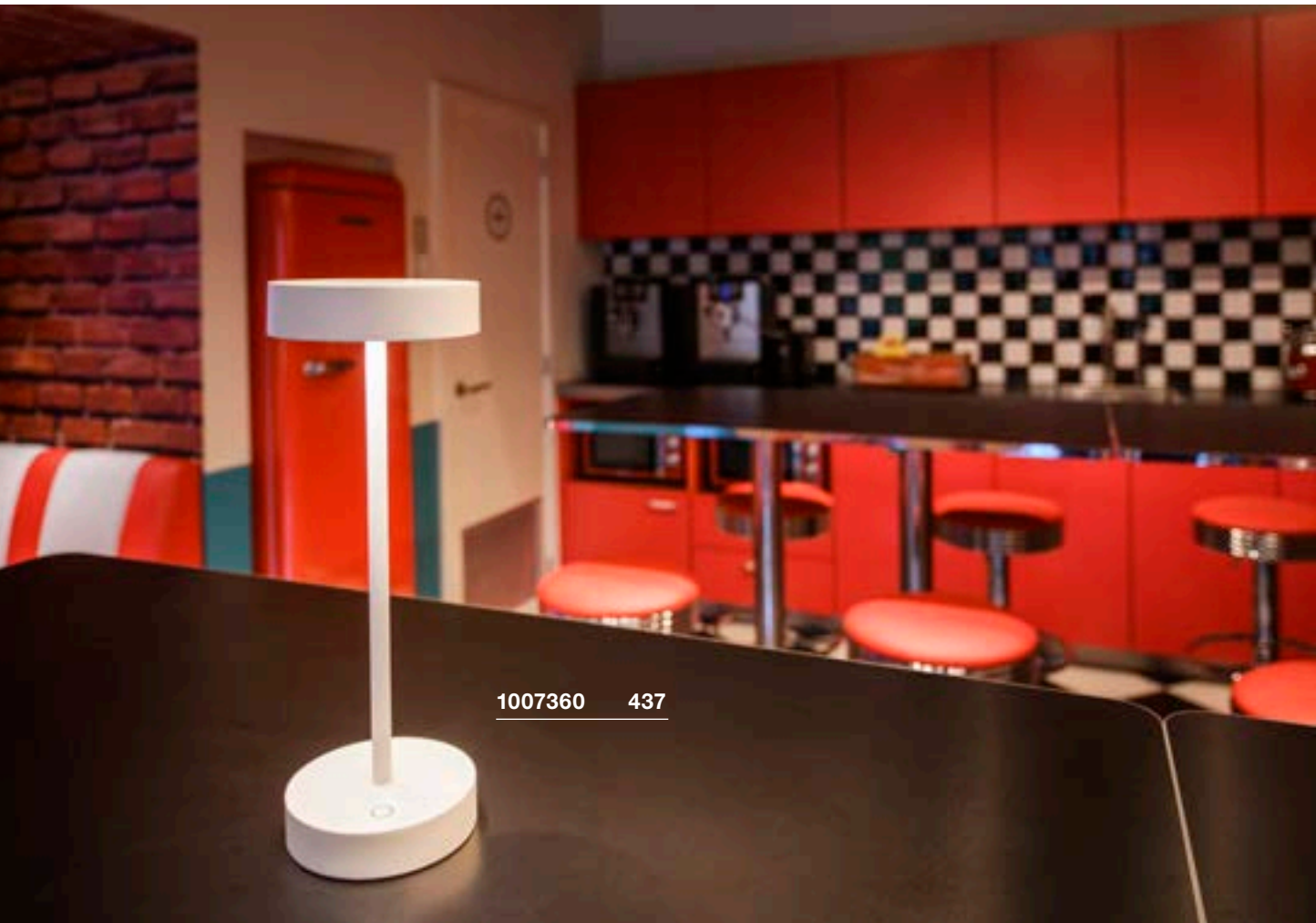

1007360 437



## VINOLINA ONE TL, Bateria

## VINOLINA TL, Bateria

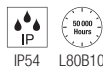
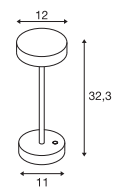
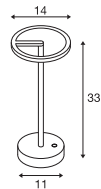
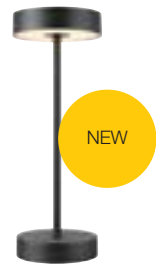

Funcionamento com bateria de 5V  
Potência total: 2,5W  
Material: alumínio

- Duração 12h
- Tempo de carregamento 7h
- Inclui Casquilho de carregamento
- Não inclui fonte de alimentação
- USB A

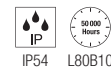

Funcionamento com bateria de 5V  
Potência total: 2,2W  
Material: alumínio

- Duração 12h
- Tempo de carregamento 7h
- Inclui Casquilho de carregamento
- Não inclui fonte de alimentação
- USB A



Down 125lm | 2700K



Down 130lm | 2700K | 130lm | 3000K

Variante	Art. n.º	EUR
● preto	1007359	139,00
○ Branco	1007357	139,00
● oxidado	1007358	139,00

Variante	Art. n.º	EUR
● preto	1007362	139,00
○ Branco	1007360	139,00
● oxidado	1007361	139,00



1007692 439



## VINOLINA TWO TL, Bateria

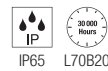
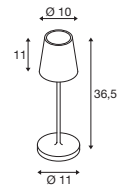

Funcionamento com bateria de 5V  
Potência total: 2W  
Material: alumínio

- Touch regulável
- Duração 10h
- Tempo de carregamento 5h
- Inclui Casquilho de carregamento para uma luminária



Down 190lm | 2200K  
2700K  
3000K

Variante	Art. n.º	EUR
● preto	1007693	139,00
○ Branco	1007692	139,00
● areia	1007697	139,00
● oxidado	1007695	139,00
● vermelho	1007694	139,00
● verde-lima	1007696	139,00

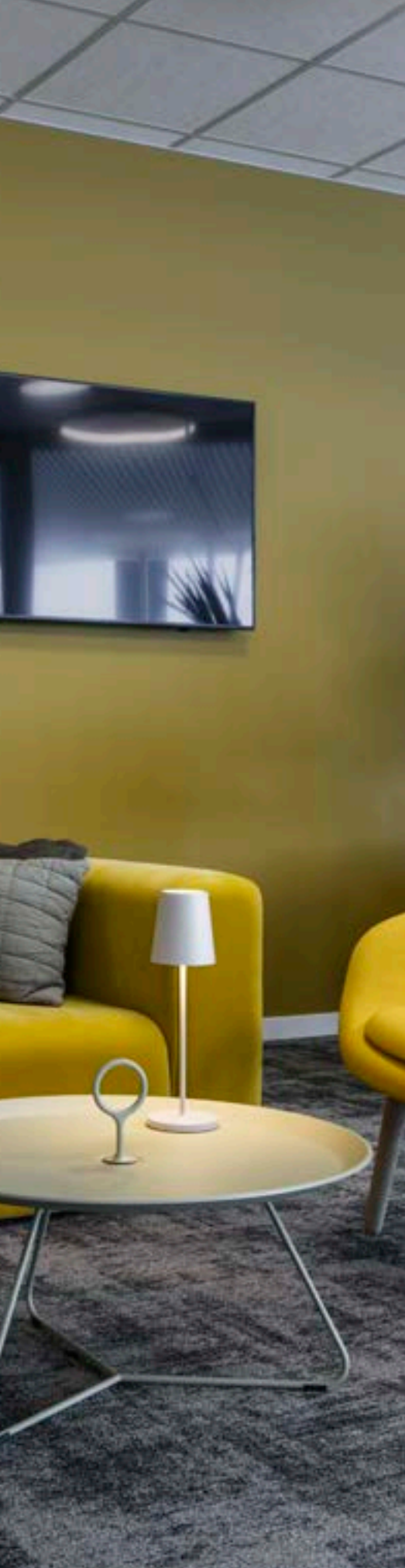



1007380 441





## TAHA

Luminária com transf., BATERIA

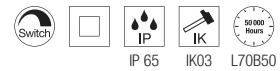
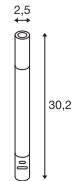

100-240V ~50/60Hz | Funcionamento com bateria de 5V  
 Potência total: 5W  
 Transformador com saída no máx. 5V DC  
 Material: alumínio/plástico

- Inclui cabo de carregamento



Down

200lm | 2700K

Variante	Art. n.º	EUR
● preto	1007380	● 159,00





1007366 443

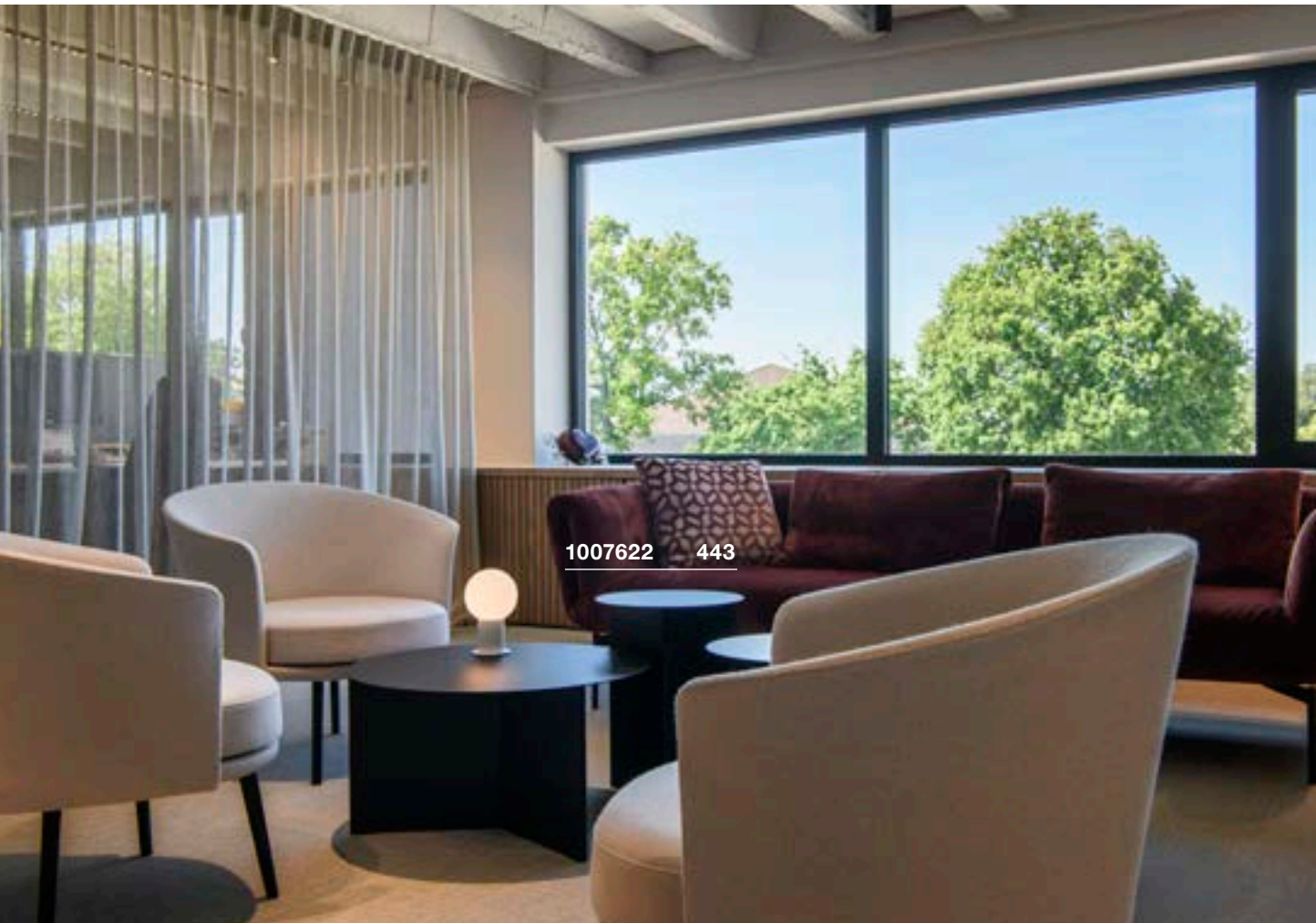

1007622 443



TINY SUN  
TL

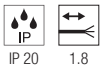
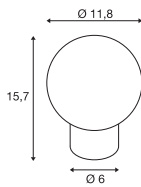

220-240V ~50/60Hz  
Material: aço

- Ficha Euro



Casquilho: 1xG9 Máx. Ø: 3 cm C: 6 cm

Variante	Art. n.º	EUR
● Cobre	1007364	99,00
● Bronze	1007363	99,00



LED G9 | 3.6W | 300°  
3000K | 400lm | EE=E  
4kWh/1000h

Art. N.º: 1005286 | 9,99 EUR

LITTLE SUN  
TL

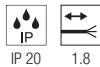
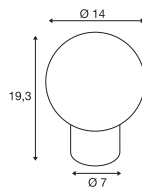

220-240V ~50/60Hz  
Material: aço

- Ficha Euro



Casquilho: 1xG9 Máx. Ø: 3 cm C: 6 cm

Variante	Art. n.º	EUR
● Cobre	1007366	109,00
● Bronze	1007365	109,00



LED G9 | 3.6W | 300°  
3000K | 400lm | EE=E  
4kWh/1000h

Art. N.º: 1005286 | 9,99 EUR

VARYT  
TL, E14

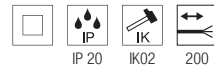
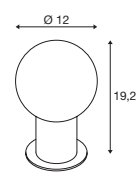

220-240V ~50/60Hz  
Material: alumínio/aço

- Ficha Euro



Casquilho: 1xE14 Máx. Ø: 3,8 cm C: 11 cm

Variante	Art. n.º	EUR
● preto	1007620	145,00
○ Branco	1007622	145,00
● Bronze	1007623	180,00
● Cromado	1007621	160,00



C35 | 4,2W | 320°  
2700K | 350lm | EE=G  
5kWh/1000h

Art. N.º: 1005285 | 8,50 EUR



WORKLIGHT PRO  
FL, single

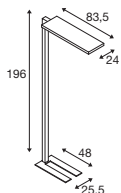
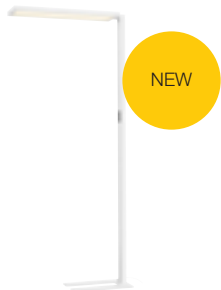

200-240V ~50/60Hz | 48V  
Potência total: 100W  
Material: alumínio/aço

- Ficha de segurança Touch regulável



Up 10700lm | 4000K  
Down 2300lm

Variante	Art. n.º	EUR
● preto	1007462	950,00
○ Branco	1007463	950,00
● Cinzento	1007464	950,00

WORKLIGHT PRO  
FL, double

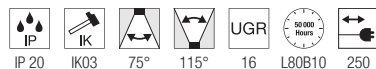
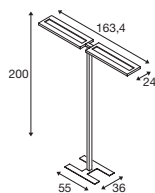
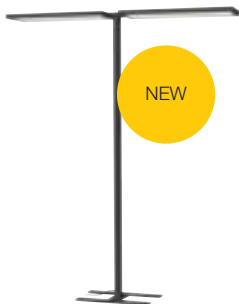

200-240V ~50/60Hz | 48V  
Potência total: 150W  
Material: alumínio/aço

- Ficha de segurança Touch regulável



Up 15600lm | 4000K  
Down 4400lm

Variante	Art. n.º	EUR
● preto	1007465	1.749,00
○ Branco	1007466	1.749,00
● Cinzento	1007467	1.749,00





1006344 445

## WORKLIGHT TL

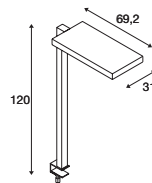

IP 20 IK02 80° 110° UGR 19 L80B10  
  
 250

200-240V ~50/60Hz | 2000mA  
 Potência total: 79W  
 Material: alumínio

- Alcance de fixação de: 6–40 mm
- Ficha schuko
- Regulável por botão tátil



Up 3800lm | 4000K  
 Down 3800lm

Variante	Art. n.º	EUR
● preto	1005392	699,00
○ Branco	1005394	699,00
● Prateado	1006344	699,00

## WORKLIGHT FL

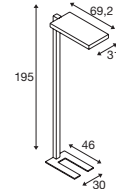

IP 20 IK02 80° 110° UGR 19 L80B10  
  
 250

200-240V ~50/60Hz | 2000mA  
 Potência total: 79W  
 Material: alumínio

- Ficha schuko
- Regulável por botão tátil



Up 3800lm | 4000K  
 Down 3800lm

Variante	Art. n.º	EUR
● preto	1005390	799,00
○ Branco	1005391	799,00
● Prateado	1006343	799,00



1005391 445



132660 + 1000580 296 + 449

155790 + 155592 447 + 449

155780 + 155592 447 + 449

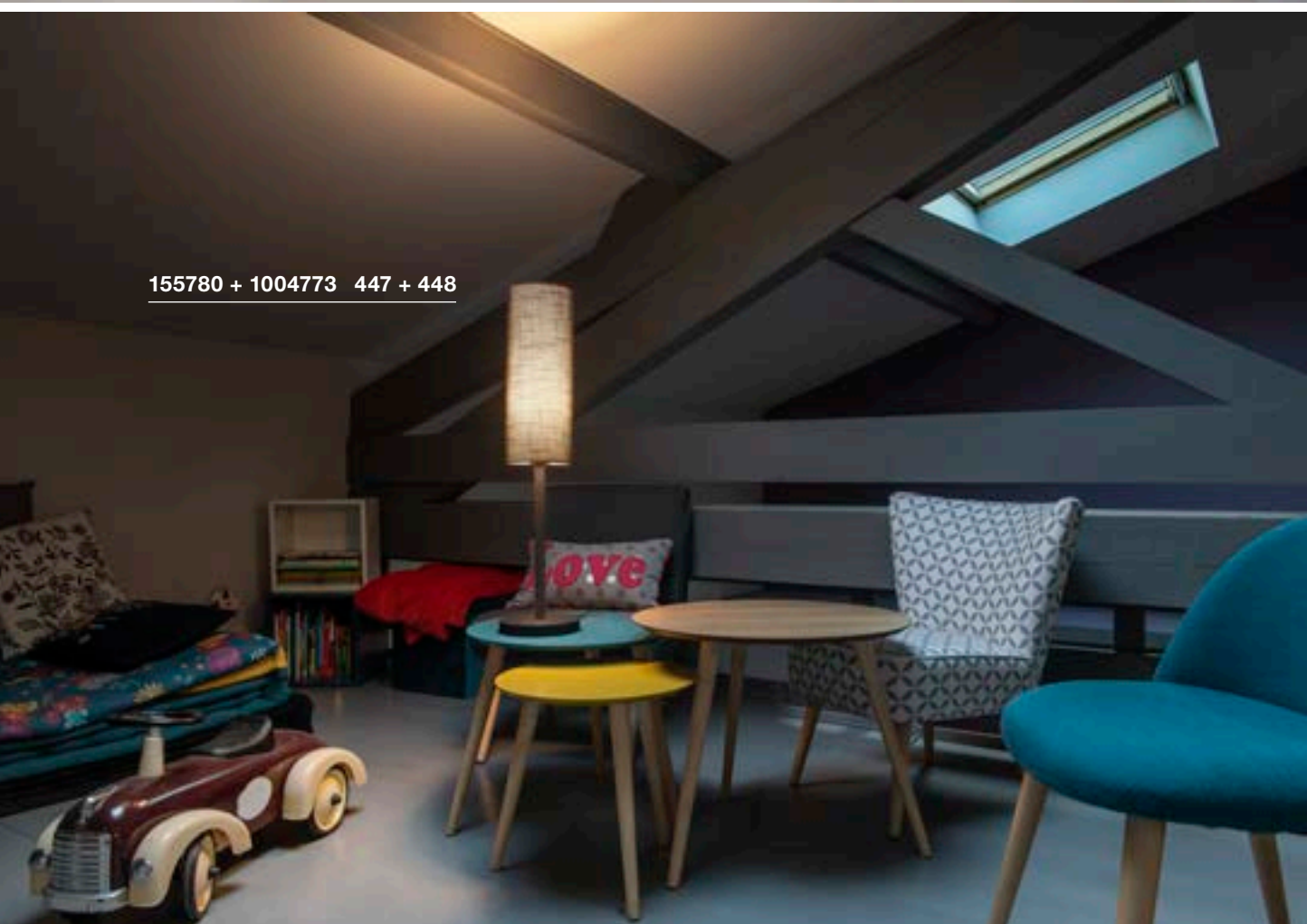

155780 + 1004773 447 + 448



### FENDA TL, E27

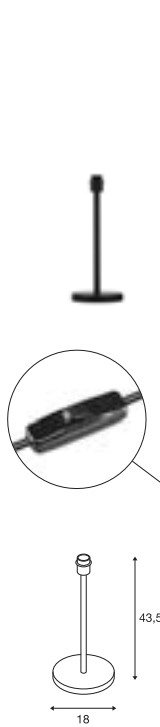

220-240V ~50/60Hz  
Material: aço

- Ficha Euro e interruptor



Casquilho: 1xE27

Variante	Art. n.º	EUR
● preto	155780	80,00



A60 | 7,5W | 320°  
2700K | 800lm | EE=F  
8kWh/1000h



Art. N.º: 1005303 | 9,60 EUR

### FENDA FL, E27

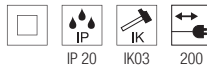

220-240V ~50/60Hz  
Material: aço/plástico

- Ficha Euro e interruptor



Casquilho: 1xE27

Variante	Art. n.º	EUR
● preto	155790	141,00



LED E27 | 13,2W | 220°  
2700K | 1300lm | EE=F  
13kWh/1000h



Art. N.º: 1005302 | 12,25 EUR

### FENDA TL, E27

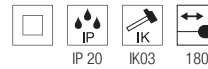
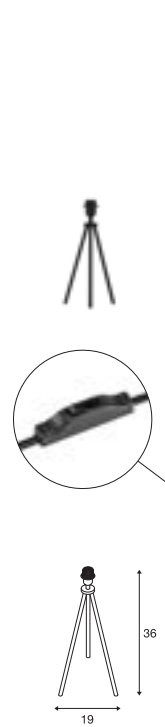

220-240V ~50/60Hz  
Material: alumínio/plástico

- Ficha Euro e interruptor



Casquilho: 1xE27

Variante	Art. n.º	EUR
● preto	155540	80,00



LED E27 | 7,5W | 320°  
2500K | 700lm | EE=F  
8kWh/1000h



Art. N.º: 1005265 | 26,50 EUR

FENDA  
FL, E27

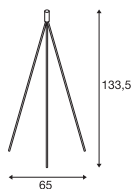

220-240V ~50/60Hz  
Material: alumínio

- Interruptor na parte superior da luminária
- Ficha Euro

**SOCKET INSIDE** <40 W

Casquilho: 1xE27

Variante	Art. n.º	EUR
● preto	155490	132,00



LED E27 | 13,2W | 220°  
2700K | 1300lm | EE=F  
13kWh/1000h



Art. N.º: 1005302 | 12,25 EUR

FENDA BOW BASIS  
FL, E27

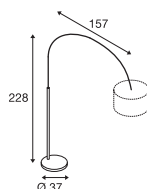

220-240V ~50/60Hz  
Material: aço

- Peso máx. permitido do abajur 900 g
- Ficha Euro e interruptor

**SOCKET INSIDE** <25 W

Casquilho: 1xE27

Máx. C: 17,5 cm

Variante	Art. n.º	EUR
● preto	1003029	248,00
● Cromado	1000763	262,00



A60 | 7,5W | 320°  
2700K | 800lm | EE=F  
8kWh/1000h



Art. N.º: 1005303 | 9,60 EUR

FENDA  
15 cm, Redondo



A: 40 cm  
Ø: 15 cm  
Material: têxtil/aço

Variante	Art. n.º	EUR
● Preto/cobre	156152	53,00
○ Branco	156141	44,75
● Cinzento	1004773	44,75
● Bege	156143	44,75



155490 + 1004773 448 + 449





FENDA  
30 cm, Redondo



A: 20 cm  
Ø: 30 cm  
Material: têxtil/aço

FENDA  
Ø 45 cm, Redondo



A: 28 cm  
Ø: 45,5 cm  
Material: têxtil/aço

FENDA  
Ø 70 cm, Redondo



A: 36 cm  
Ø: 70 cm  
Material: têxtil/aço

• Não é adequado para Fenda Bow.

Variante	Art. n.º	EUR
● Preto/cobre	155592	70,00
○ Branco	155582	53,00
● Cinzento	1004774	53,00
● Bege	155583	53,00

Variante	Art. n.º	EUR
● Preto/cobre	156122	88,00
○ Branco	156111	83,00
● Cinzento	1004775	83,00
● Bege	156113	83,00

Variante	Art. n.º	EUR
● Preto/cobre	1000580	129,00
○ Branco	1000579	112,00



1003032 448

# MIX & MATCH FENDA

## FENDA Ø15

Preto	156152
Branco	156141
Bege	156143
Cinzentos	1004773

## FENDA Ø30

Preto	155592
Branco	155582
Bege	155583
Cinzentos	1004774

## FENDA Ø45

Preto	156122
Branco	156111
Bege	156113
Cinzentos	1004775

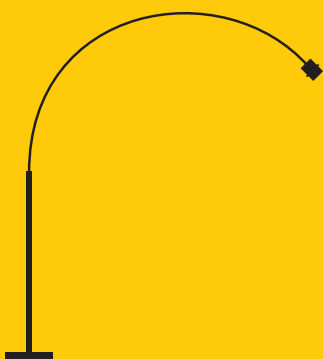

### FENDA BOW

Preto	1003029
Cromado	1000763



### FENDA TL

Preto	155780
-------	--------



### FENDA FL

Preto	155790
-------	--------



### FENDA TL

Preto	155540
-------	--------



### FENDA FL

Preto	155490
-------	--------

Combine os produtos SLV Mix & Match de acordo com o seu gosto. Perfeitamente compatíveis entre si, encontra artigos a combinar não só na família FENDA mas também entre as famílias de produtos FENDA e FITU. Identifica os produtos SLV Mix & Match pelo seguinte símbolo:



**MIX**  
match

## FENDA Ø70

Preto | 1000580  
Branco | 1000579



## FENDA Ø12,5

*Glass Shade*

Castanho | 1000773



## FENDA PD

Preto | 132660  
Branco | 132661  
Cromado | 132662

## FENDA CL

Preto | 155550  
Branco | 155551

## FITU CRANE BASE

Preto | 1004682



## FITU PD

Preto | 132690  
Branco | 132691

KARPO  
TL

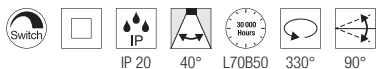
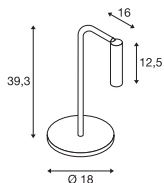

200-240V ~50/60Hz | 500mA  
Potência total: 6,2W  
Material: alumínio

- Interruptor na cabeça da luminária
- Ficha com transformador



Down 360lm | 430lm | 3000K

Variante	Art. n.º	EUR
● preto 360 lm	1001461	186,00
○ Branco 430 lm	1001460	186,00

KARPO  
FL

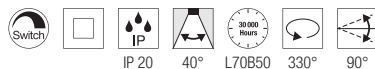
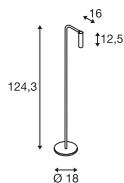

200-240V ~50/60Hz | 500mA  
Potência total: 6,2W  
Material: alumínio

- Interruptor na cabeça da luminária
- Ficha com transformador



Down 360lm | 430lm | 3000K

Variante	Art. n.º	EUR
● preto 360 lm	1001463	242,00
○ Branco 430 lm	1001462	242,00

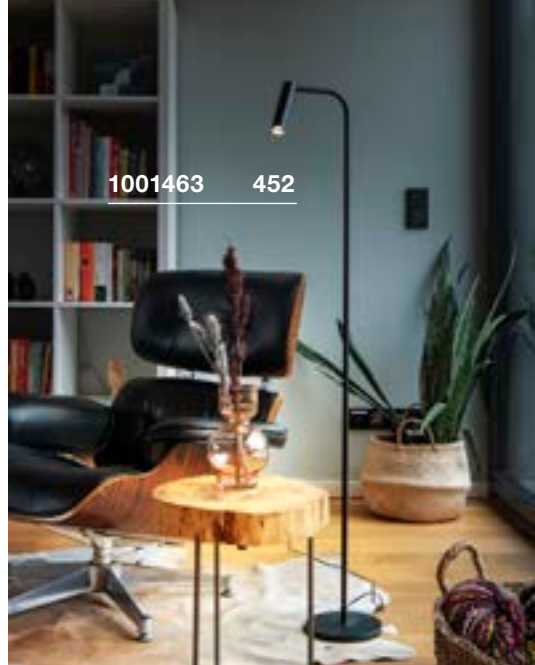

1001463 452

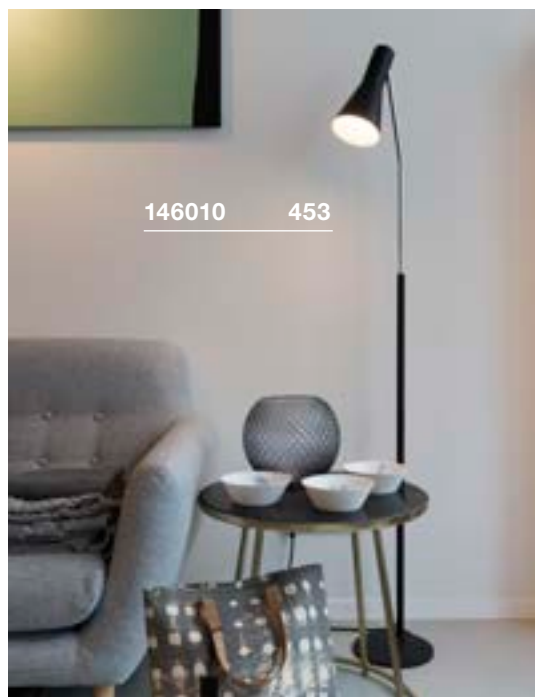

146010 453

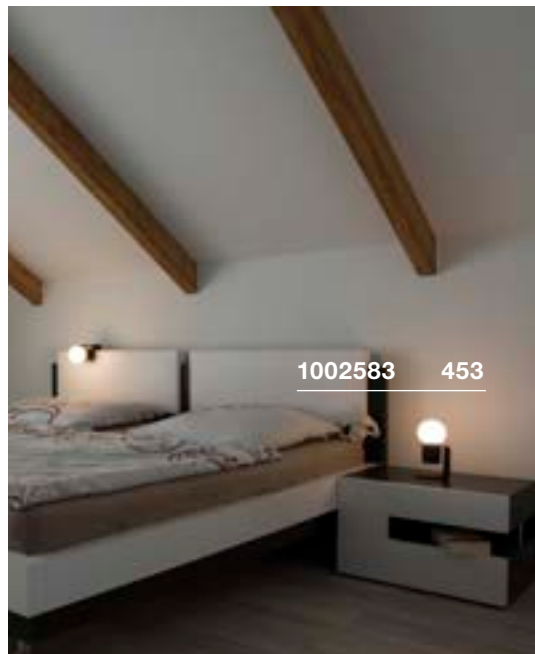

1002583 453



## PHELIA FL, E27

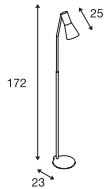

220-240V ~50/60Hz  
Material: alumínio/aço

- Interruptor na cabeça da luminária
- Ficha de segurança e interruptor



Casquilho: 1xE27    Máx. Ø: 5,3 cm    C: 18 cm

Variante	Art. n.º	EUR
● preto	146010	242,00



A60 | 7,5W | 320°  
2700K | 800lm | EE=F  
8kWh/1000h



Art. N.º: 1005303 | 9,60 EUR

## TONILA TL

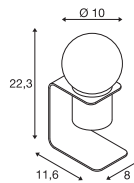

Funcionamento com bateria de 5V  
Potência total: 1,6W  
Material: alumínio/plástico

- Bateria de 3,6 V 2000 mAh incluída
- Sem fonte de alimentação, requer um carregador USB de 5 V CC/1-2 A. Para cabo de carregamento MINI USB.
- Botão com possibilidade de regulação de intensidade de 3 níveis.



Down    90lm | 2700K

Variante	Art. n.º	EUR
● preto	1002583	118,00

## MAGANDA TL

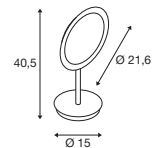

100-240V ~50/60Hz | 12V  
Potência total: 4,8W  
Material: aço/vidro

- Botão com possibilidade de alteração da temperatura de cor (2700/3000/4000K).
- Ficha schuko IP44



45lm | 2700K    48lm | 3000K    51lm | 4000K

Variante	Art. n.º	EUR
● Cromado/fosco	1004970	181,00

1006672 469

1006623 475

1006834 471





NEW



NUMINOS® XS | 468



NEW



NUMINOS® S | 468



NEW



NUMINOS® XS | 470



NEW



NUMINOS® S | 470



NEW



IN-LINE 22 | 473



NEW



IN-LINE 22 | 473



NEW



IN-LINE 44 | 475



NEW



IN-LINE 44 | 475



NEW



IN-LINE 24 | 477



NEW



IN-LINE 46 | 477

1006623 + 1006617 475 + 473







# CALHA ELETRIFICADA 48V

Calha eletrificada saliente DALI

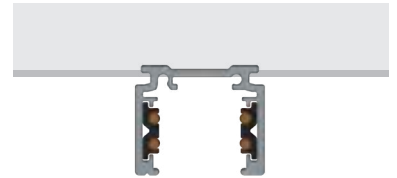

	1 m	1 m	2 m	2 m
Tensão nominal (V)	48V DC	48V DC	48V DC	48V DC
Intensidade máx. de corrente (A)	16	16	16	16
Carga mec. máx.	5 kg	5 kg	10 kg	10 kg
Cor	● Preto	○ Branco	● Preto	○ Branco
Material	Alumínio	Alumínio	Alumínio	Alumínio
C x L x A (cm)	100 x 2,62 x 2,26	100 x 2,62 x 2,26	200 x 2,62 x 2,26	200 x 2,62 x 2,26
Art. n.º	1006541 ●	1006542 ●	1006543 ●	1006544 ●
EUR	49,00	49,00	84,00	84,00
	3 m	3 m	4 m	4 m
Tensão nominal (V)	48V DC	48V DC	48V DC	48V DC
Intensidade máx. de corrente (A)	16	16	16	16
Carga mec. máx.	15 kg	15 kg	20 kg	20 kg
Cor	● Preto	○ Branco	● Preto	○ Branco
Material	Alumínio	Alumínio	Alumínio	Alumínio
C x L x A (cm)	300 x 2,62 x 2,26	300 x 2,62 x 2,26	400 x 2,62 x 2,26	400 x 2,62 x 2,26
Art. n.º	1006545 ●	1006546 ●	1006547 ●	1006548 ●
EUR	132,00	132,00	180,00	180,00



# CALHA ELETRIFICADA 48V

Calha eletrificada saliente DALI  
Guia de planeamento e visão geral de acessórios

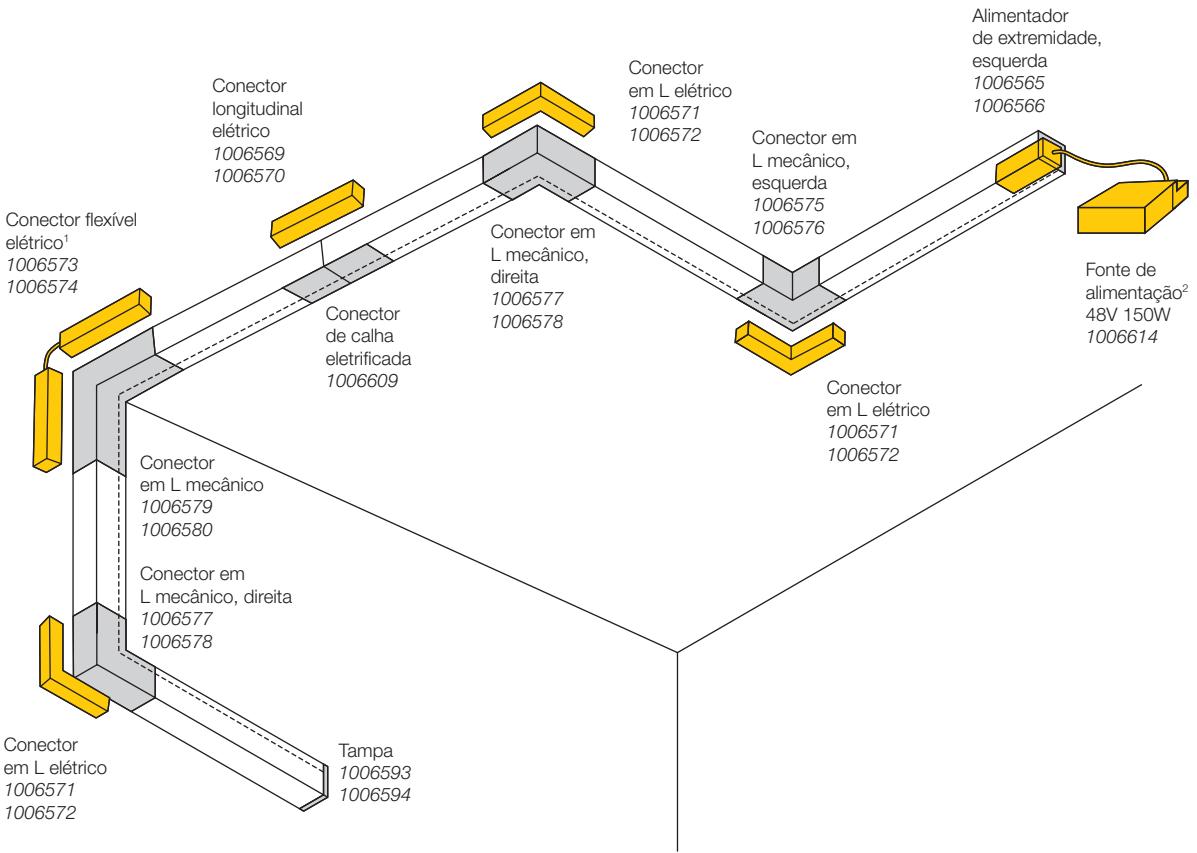

<sup>1</sup> Tenha em atenção que conectores elétricos e mecânicos têm de ser sempre instalados juntos.  
<sup>2</sup> A fonte de alimentação deve ser colocada externamente.



**Alimentador de extremidade, direita**  
16A máx. | Policarbonato (PC)  
C: 9,7 cm | L: 1,6 cm | A: 1,9 cm

● Preto Art. n.º 1006567 14,00 EUR  
○ Branco Art. n.º 1006568 14,00 EUR

**Transformador 48V | 60W**  
Policarbonato (PC)  
C: 18 cm | L: 4,5 cm | A: 2,7 cm

○ Branco Art. n.º 1006613 59,00 EUR

**Alimentador de extremidade, esquerda**  
16A máx. | Policarbonato (PC)  
C: 9,7 cm | L: 1,6 cm | A: 1,9 cm

● Preto Art. n.º 1006565 14,00 EUR  
○ Branco Art. n.º 1006566 14,00 EUR

**Transformador 48V | 150W**  
Metal/Policarbonato (PC)  
C: 19,05 cm | L: 8,8 cm | A: 3,55 cm

● Preto Art. n.º 1006614 129,00 EUR

**Conector em L mecânico, p/ calha eletrificada saliente padrão, direita, (p/ instalação no teto)**  
Alumínio  
C: 7,1 cm | L: 7,1 cm | A: 2,19 cm

● Preto Art. n.º 1006577 21,00 EUR  
○ Branco Art. n.º 1006578 21,00 EUR

**Cobertura, 20 mm p/ estrutura de calha padrão, 2 m**  
Alumínio /policarbonato (PC)  
C: 200 cm | L: 2 cm | A: 0,6 cm

● Preto Art. n.º 1006611 9,90 EUR  
○ Branco Art. n.º 1006612 9,90 EUR

**Conector em L mecânico, p/ calha eletrificada saliente padrão, esquerda, (p/ instalação no teto)**  
Alumínio  
C: 7,1 cm | L: 7,1 cm | A: 2,19 cm

● Preto Art. n.º 1006575 21,00 EUR  
○ Branco Art. n.º 1006576 21,00 EUR

**Tampa p/ calha eletrificada saliente padrão**  
Policarbonato (PC)  
C: 2,6 cm | L: 0,2 cm | A: 2,2 cm

● Preto Art. n.º 1006593 3,50 EUR  
○ Branco Art. n.º 1006594 3,50 EUR

**Conector em L mecânico, p/ calha eletrificada saliente, padrão, Stereo, (parede/teto)**  
Alumínio  
C: 8,4 cm | L: 2,62 cm | A: 8,4 cm

● Preto Art. n.º 1006579 21,00 EUR  
○ Branco Art. n.º 1006580 21,00 EUR

**Placa de reforço de calhas p/ calha eletrificada saliente**  
Aço  
C: 5 cm | L: 1,32 cm | A: 0,25 cm

● Cinzento Art. n.º 1006609 8,80 EUR

**Conector em L elétrico, DALI**  
16A máx. | Policarbonato (PC)  
C: 11,4 cm | L: 11,4 cm | A: 1,9 cm

● Preto Art. n.º 1006571 27,00 EUR  
○ Branco Art. n.º 1006572 27,00 EUR

**Placa de reforço de calhas com conjunto de suspensão, cabo de aço de 3 m**  
Aço  
C: 12 cm | L: 2,7 cm

● Preto Art. n.º 1006603 21,00 EUR  
○ Branco Art. n.º 1006604 21,00 EUR

**Conector longitudinal elétrico, DALI**  
16A máx. | Policarbonato (PC)  
C: 14,4 cm | L: 1,6 cm | A: 1,9 cm

● Preto Art. n.º 1006569 21,00 EUR  
○ Branco Art. n.º 1006570 21,00 EUR

**Placa de reforço de calhas com conjunto de suspensão, haste de 1 m**  
Aço  
C: 12 cm | L: 2,7 cm

● Preto Art. n.º 1006601 21,00 EUR  
○ Branco Art. n.º 1006602 21,00 EUR

**Conector flexível, elétrico, DALI**  
16A máx. | Policarbonato (PC)  
C: 23 cm | L: 1,6 cm | A: 1,9 cm

● Preto Art. n.º 1006573 29,00 EUR  
○ Branco Art. n.º 1006574 29,00 EUR

**Estrutura suspensa, haste de 1 m**  
Aço  
L: 2,9 cm

● Preto Art. n.º 1006605 18,00 EUR  
○ Branco Art. n.º 1006606 18,00 EUR

**Caixa de transformador incl. alimentador de extremidade direita, DALI**  
Policarbonato (PC)  
C: 23,3 cm | L: 10,1 cm | A: 4,1 cm

● Preto Art. n.º 1007137 35,00 EUR  
○ Branco Art. n.º 1007138 35,00 EUR

**Estrutura suspensa, cabo de aço de 3 m**  
Aço  
L: 2,9 cm

● Preto Art. n.º 1006607 18,00 EUR  
○ Branco Art. n.º 1006608 18,00 EUR

**Caixa de transformador incl. alimentador de extremidade esquerdo, DALI**  
Policarbonato (PC)  
C: 23,3 cm | L: 10,1 cm | A: 4,1 cm

● Preto Art. n.º 1007083 35,00 EUR  
○ Branco Art. n.º 1007084 35,00 EUR

**Grampo de fixação**  
Alumínio  
C: 3 cm | L: 2,72 cm | A: 1,05 cm

● Preto Art. n.º 1006599 7,50 EUR  
○ Branco Art. n.º 1006600 7,50 EUR

1006726 + 1006623 + 1006617 469 + 475 + 473

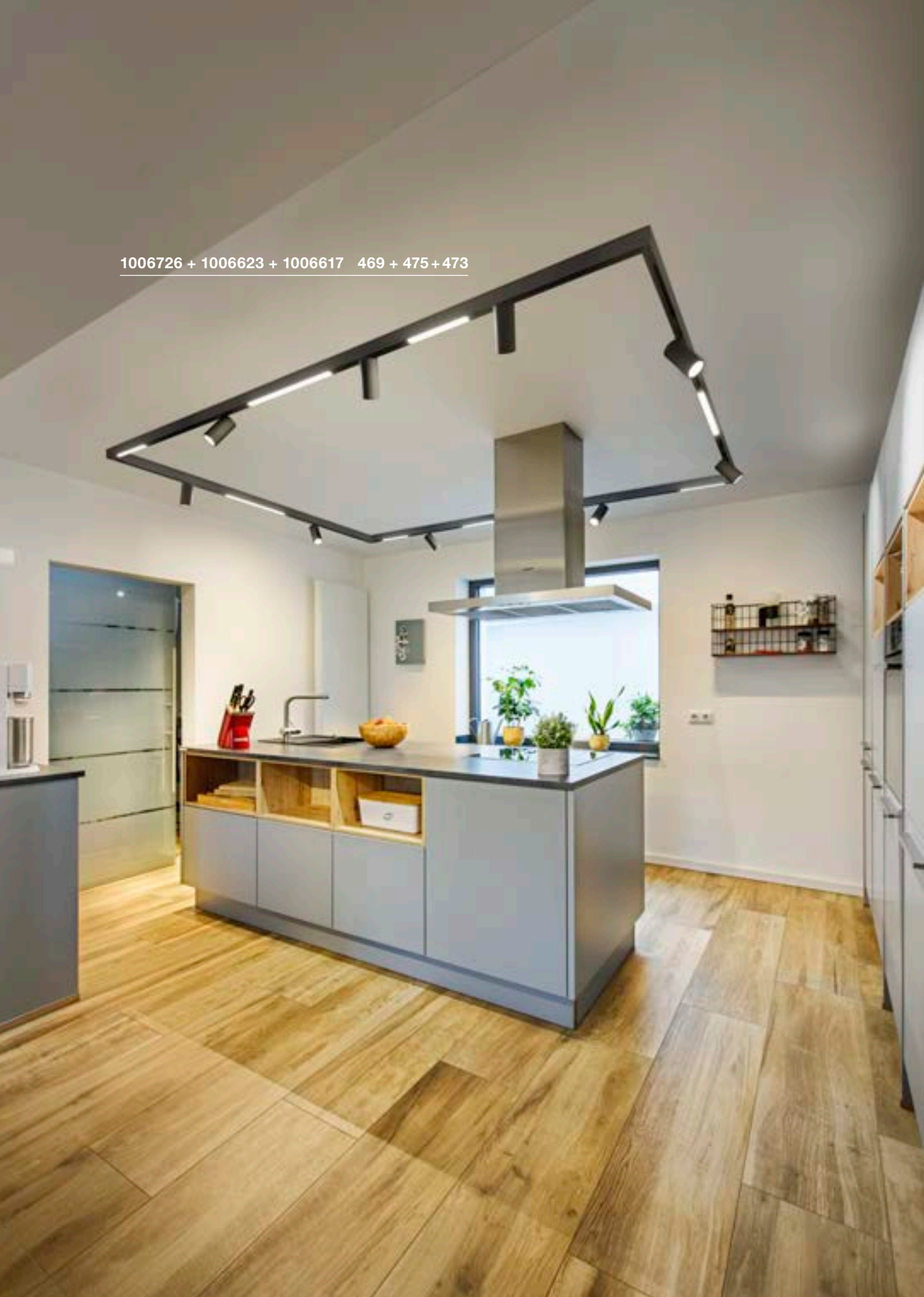



# CALHA ELETRIFICADA 48V

Calha eletrificada saliente em profundidade DALI

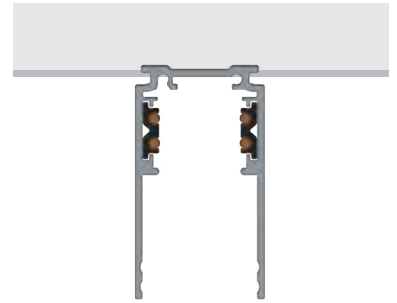

	1 m	1 m	2 m	2 m
Tensão nominal (V)	48V DC	48V DC	48V DC	48V DC
Intensidade máx. de corrente (A)	16	16	16	16
Carga mec. máx.	5 kg	5 kg	10 kg	10 kg
Cor	● Preto	○ Branco	● Preto	○ Branco
Material	Alumínio	Alumínio	Alumínio	Alumínio
C x L x A (cm)	100 x 2,62 x 4,72	100 x 2,62 x 4,72	200 x 2,62 x 4,72	200 x 2,62 x 4,72
Art. n.º	1006549 ●	1006550 ●	1006551 ●	1006552 ●
EUR	59,00	59,00	115,00	115,00
	3 m	3 m	4 m	4 m
Tensão nominal (V)	48V DC	48V DC	48V DC	48V DC
Intensidade máx. de corrente (A)	16	16	16	16
Carga mec. máx.	15 kg	15 kg	20 kg	20 kg
Cor	● Preto	○ Branco	● Preto	○ Branco
Material	Alumínio	Alumínio	Alumínio	Alumínio
C x L x A (cm)	300 x 2,62 x 4,72	300 x 2,62 x 4,72	400 x 2,62 x 4,72	400 x 2,62 x 4,72
Art. n.º	1006553 ●	1006554 ●	1006555 ●	1006556 ●
EUR	170,00	170,00	228,00	228,00



NEW

## CALHA ELETRIFICADA 48V



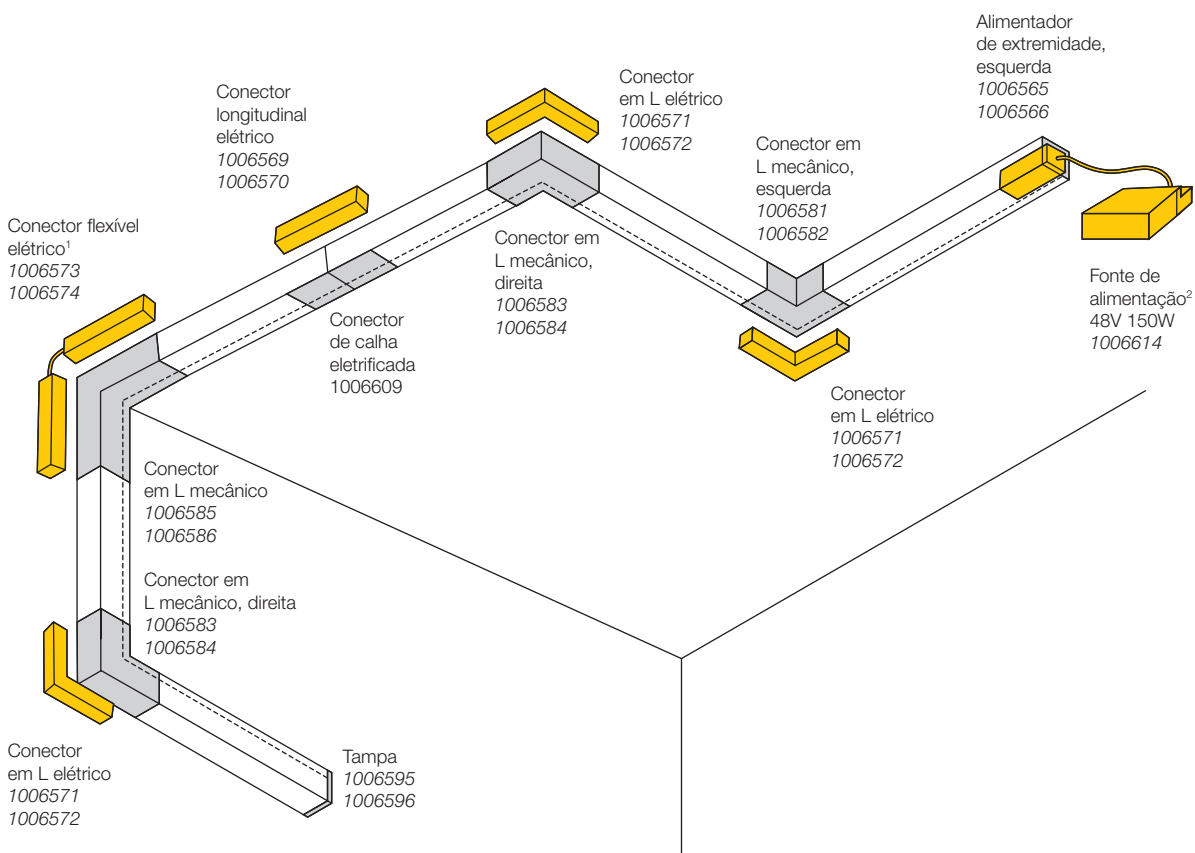





Calha eletrificada saliente em profundidade DALI  
Guia de planeamento e visão geral de acessórios

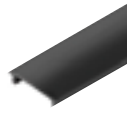

<sup>1</sup> Tenha em atenção que conectores elétricos e mecânicos têm de ser sempre instalados juntos.

<sup>2</sup> A fonte de alimentação deve ser colocada externamente.



 <p><b>Alimentador de extremidade, direita</b> 16A máx.   Policarbonato (PC) C: 9,7 cm   L: 1,6 cm   A: 1,9 cm</p> <p>● Preto Art. n.º 1006567 14,00 EUR ○ Branco Art. n.º 1006568 14,00 EUR</p>	 <p><b>Transformador 48V   60W</b> Policarbonato (PC) C: 18 cm   L: 4,5 cm   A: 2,7 cm</p> <p>○ Branco Art. n.º 1006613 59,00 EUR</p>
 <p><b>Alimentador de extremidade, esquerda</b> 16A máx.   Policarbonato (PC) C: 9,7 cm   L: 1,6 cm   A: 1,9 cm</p> <p>● Preto Art. n.º 1006565 14,00 EUR ○ Branco Art. n.º 1006566 14,00 EUR</p>	 <p><b>Transformador 48V   150W</b> Metal/Policarbonato (PC) C: 19,05 cm   L: 8,8 cm   A: 3,55 cm</p> <p>● Preto Art. n.º 1006614 129,00 EUR</p>
 <p><b>Conector em L mecânico p/ calha eletrificada saliente em profundidade, direita, (p/ instalação no teto)</b> Alumínio C: 7,1 cm   L: 7,1 cm   A: 4,7 cm ● Preto Art. n.º 1006583 29,00 EUR ○ Branco Art. n.º 1006584 29,00 EUR</p>	 <p><b>Tampa de calha, 26 mm, p/ calha eletrificada saliente em profundidade e de montagem encastrada, 2 m</b> Policarbonato (PC) C: 200 cm   L: 26 cm   A: 6 cm ● Preto Art. n.º 1007188 12,00 EUR ○ Branco Art. n.º 1007189 12,00 EUR</p>
 <p><b>Conector em L mecânico p/ calha eletrificada saliente em profundidade, esquerda, (p/ instalação no teto)</b> Alumínio C: 7,1 cm   L: 7,1 cm   A: 4,7 cm ● Preto Art. n.º 1006581 29,00 EUR ○ Branco Art. n.º 1006582 29,00 EUR</p>	 <p><b>Tampa p/ calha eletrificada saliente em profundidade</b> Policarbonato (PC) C: 2,6 cm   L: 0,2 cm   A: 4,7 cm</p> <p>● Preto Art. n.º 1006595 6,50 EUR ○ Branco Art. n.º 1006596 6,50 EUR</p>
 <p><b>Conector em L mecânico, p/ calha eletrificada saliente, em profundidade, Stereo (parede/teto)</b> Alumínio C: 8,4 cm   L: 8,4 cm   A: 4,7 cm ● Preto Art. n.º 1006585 29,00 EUR ○ Branco Art. n.º 1006586 29,00 EUR</p>	 <p><b>Placa de reforço de calhas p/ calha eletrificada saliente</b> Aço C: 5 cm   L: 1,32 cm   A: 0,25 cm</p> <p>● Cinzento Art. n.º 1006609 8,80 EUR</p>
 <p><b>Conector em L elétrico, DALI</b> 16A máx.   Policarbonato (PC) C: 11,4 cm   L: 11,4 cm   A: 1,9 cm</p> <p>● Preto Art. n.º 1006571 27,00 EUR ○ Branco Art. n.º 1006572 27,00 EUR</p>	 <p><b>Placa de reforço de calhas com conjunto de suspensão, cabo de aço de 3 m</b> Aço C: 12 cm   L: 2,7 cm</p> <p>● Preto Art. n.º 1006603 21,00 EUR ○ Branco Art. n.º 1006604 21,00 EUR</p>
 <p><b>Conector longitudinal elétrico, DALI</b> 16A máx.   Policarbonato (PC) C: 14,4 cm   L: 1,6 cm   A: 1,9 cm</p> <p>● Preto Art. n.º 1006569 21,00 EUR ○ Branco Art. n.º 1006570 21,00 EUR</p>	 <p><b>Placa de reforço de calhas com conjunto de suspensão, haste de 1 m</b> Aço C: 12 cm   L: 2,7 cm</p> <p>● Preto Art. n.º 1006601 21,00 EUR ○ Branco Art. n.º 1006602 21,00 EUR</p>
 <p><b>Conector flexível, elétrico, DALI</b> 16A máx.   Policarbonato (PC) C: 23 cm   L: 1,6 cm   A: 1,9 cm</p> <p>● Preto Art. n.º 1006573 29,00 EUR ○ Branco Art. n.º 1006574 29,00 EUR</p>	 <p><b>Estrutura suspensa, haste de 1 m</b> Aço L: 2,9 cm</p> <p>● Preto Art. n.º 1006605 18,00 EUR ○ Branco Art. n.º 1006606 18,00 EUR</p>
 <p><b>Caixa de transformador incl. alimentador de extremidade direita, DALI</b> Policarbonato (PC) C: 23,3 cm   L: 10,1 cm   A: 4,1 cm</p> <p>● Preto Art. n.º 1007137 35,00 EUR ○ Branco Art. n.º 1007138 35,00 EUR</p>	 <p><b>Estrutura suspensa, cabo de aço de 3 m</b> Aço L: 2,9 cm</p> <p>● Preto Art. n.º 1006607 18,00 EUR ○ Branco Art. n.º 1006608 18,00 EUR</p>
 <p><b>Caixa de transformador incl. alimentador de extremidade esquerdo, DALI</b> Policarbonato (PC) C: 23,3 cm   L: 10,1 cm   A: 4,1 cm</p> <p>● Preto Art. n.º 1007083 35,00 EUR ○ Branco Art. n.º 1007084 35,00 EUR</p>	 <p><b>Grampo de fixação</b> Alumínio C: 3 cm   L: 2,72 cm   A: 1,05 cm</p> <p>● Preto Art. n.º 1006599 7,50 EUR ○ Branco Art. n.º 1006600 7,50 EUR</p>

1006783 + 1006672 + 1006635 471 + 471 + 475

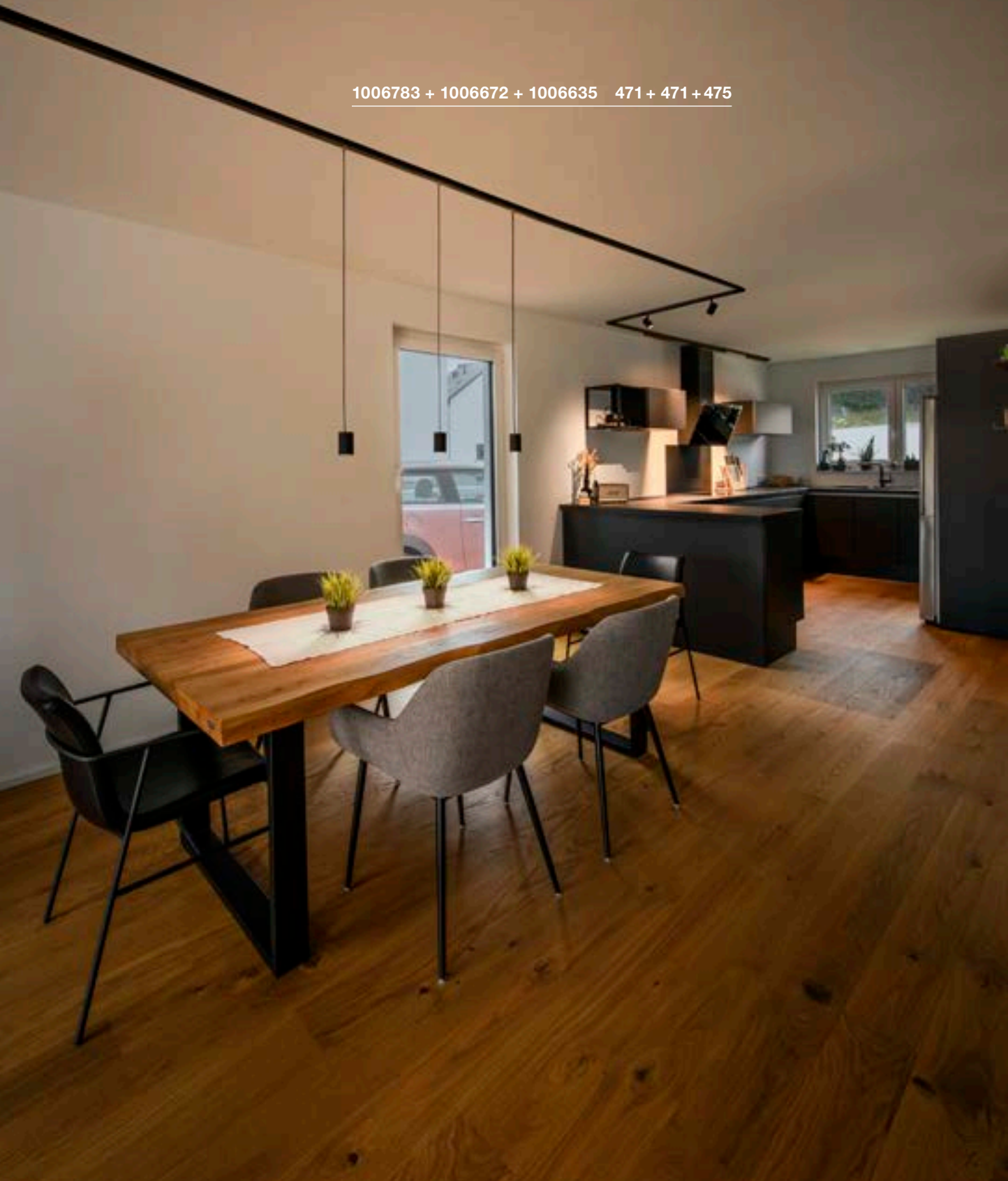





NEW

# CALHA ELETRIFICADA 48V

Calha eletrificada de montagem encastrada DALI

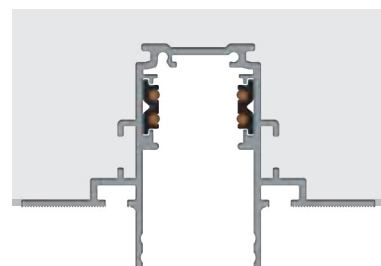

	<b>1 m</b>	<b>1 m</b>	<b>2 m</b>	<b>2 m</b>
Tensão nominal (V)	48V DC	48V DC	48V DC	48V DC
Intensidade máx. de corrente (A)	16	16	16	16
Carga mec. máx.	5 kg	5 kg	10 kg	10 kg
Cor	● Preto	○ Branco	● Preto	○ Branco
Material	Alumínio	Alumínio	Alumínio	Alumínio
C x L x A (cm)	100 x 7,4 x 4,7	100 x 7,4 x 4,7	200 x 7,4 x 4,7	200 x 7,4 x 4,7
Art. n.º	<b>1006557</b> ●	<b>1006558</b> ●	<b>1006559</b> ●	<b>1006560</b> ●
EUR	<b>79,00</b>	<b>79,00</b>	<b>138,00</b>	<b>138,00</b>
	<b>3 m</b>	<b>3 m</b>	<b>4 m</b>	<b>4 m</b>
Tensão nominal (V)	48V DC	48V DC	48V DC	48V DC
Intensidade máx. de corrente (A)	16	16	16	16
Carga mec. máx.	15 kg	15 kg	20 kg	20 kg
Cor	● Preto	○ Branco	● Preto	○ Branco
Material	Alumínio	Alumínio	Alumínio	Alumínio
C x L x A (cm)	300 x 7,4 x 4,7	300 x 7,4 x 4,7	400 x 7,4 x 4,7	400 x 7,4 x 4,7
Art. n.º	<b>1006561</b> ●	<b>1006562</b> ●	<b>1006563</b> ●	<b>1006564</b> ●
EUR	<b>178,00</b>	<b>178,00</b>	<b>256,00</b>	<b>256,00</b>



# CALHA ELETRIFICADA 48V

Calha eletrificada de montagem encastrada DALI  
Guia de planeamento e visão geral de acessórios

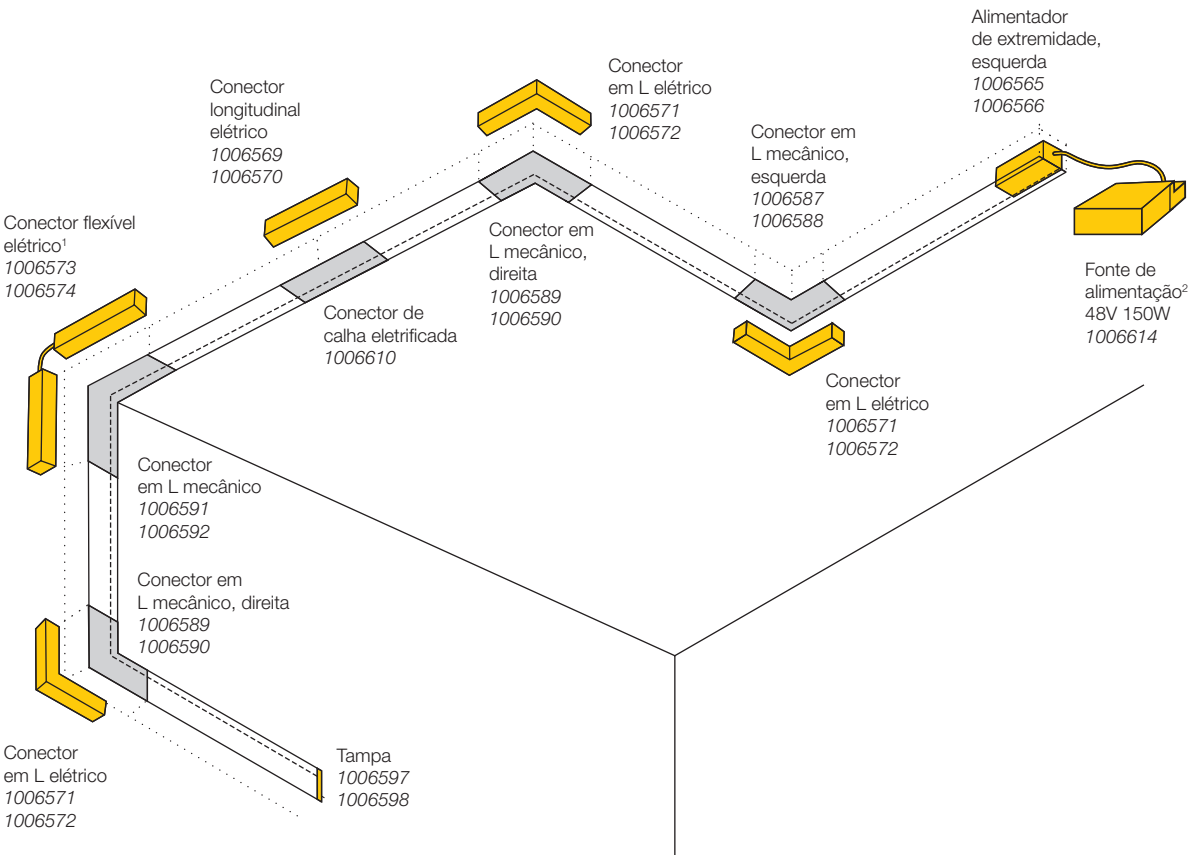

<sup>1</sup> Tenha em atenção que conectores elétricos e mecânicos têm de ser sempre instalados juntos.

<sup>2</sup> A fonte de alimentação deve ser colocada externamente.



<p><b>Alimentador de extremidade, direita</b> 16A máx.   Policarbonato (PC) C: 9,7 cm   L: 1,6 cm   A: 1,9 cm</p> <p>● Preto Art. n.º 1006567 14,00 EUR ○ Branco 1006568 14,00 EUR</p>	<p><b>Transformador 48V   60W</b> Policarbonato (PC) C: 18 cm   L: 4,5 cm   A: 2,7 cm</p> <p>○ Branco Art. n.º 1006613 59,00 EUR</p>
<p><b>Alimentador de extremidade, esquerda</b> 16A máx.   Policarbonato (PC) C: 9,7 cm   L: 1,6 cm   A: 1,9 cm</p> <p>● Preto Art. n.º 1006565 14,00 EUR ○ Branco 1006566 14,00 EUR</p>	<p><b>Transformador 48V   150W</b> Metal/Policarbonato (PC) C: 19,05 cm   L: 8,8 cm   A: 3,55 cm</p> <p>● Preto Art. n.º 1006614 129,00 EUR</p>
<p><b>Conector em L mecânico p/ calha eletrificada de montagem encastrada em profundidade, direita (p/ instalação no teto)</b> Alumínio C: 9,5 cm   L: 9,5 cm   A: 4,7 cm ● Preto Art. n.º 1006589 32,00 EUR ○ Branco 1006590 32,00 EUR</p>	<p><b>Cobertura de calha, 26 mm, 2 m</b> Policarbonato (PC) C: 200 cm   L: 26 cm   A: 6 cm</p> <p>● Preto Art. n.º 1007188 12,00 EUR ○ Branco 1007189 12,00 EUR</p>
<p><b>Conector em L mecânico p/ calha eletrificada de montagem encastrada em profundidade, esquerda (p/ instalação no teto)</b> Alumínio C: 9,5 cm   L: 9,5 cm   A: 4,7 cm ● Preto Art. n.º 1006587 32,00 EUR ○ Branco 1006588 32,00 EUR</p>	<p><b>Tampa p/ calha eletrificada montagem encastrada</b> Policarbonato (PC) C: 3,4 cm   L: 0,2 cm   A: 4,7 cm</p> <p>● Preto Art. n.º 1006597 3,50 EUR ○ Branco 1006598 3,50 EUR</p>
<p><b>Conector em L mecânico, p/ calha eletrificada de montagem encastrada, profundidade, Stereo, (parede/teto)</b> Alumínio C: 8,1 cm   L: 7,4 cm   A: 8,1 cm ● Preto Art. n.º 1006591 32,00 EUR ○ Branco 1006592 32,00 EUR</p>	<p><b>Conj. placas de reforço de calhas p/ calha eletrificada montagem encastrada</b> Aço C: 6,3 cm   L: 0,76 cm   A: 0,25 cm</p> <p>● Cinzento Art. n.º 1006610 8,80 EUR</p>
<p><b>Conector em L elétrico, DALI</b> 16A máx.   Policarbonato (PC) C: 11,4 cm   L: 11,4 cm   A: 1,9 cm</p> <p>● Preto Art. n.º 1006571 27,00 EUR ○ Branco 1006572 27,00 EUR</p>	<p><b>Placa de reforço de calhas com conjunto de suspensão, cabo de aço de 3 m</b> Aço C: 12 cm   L: 2,7 cm</p> <p>● Preto Art. n.º 1006603 21,00 EUR ○ Branco 1006604 21,00 EUR</p>
<p><b>Conector longitudinal elétrico, DALI</b> 16A máx.   Policarbonato (PC) C: 14,4 cm   L: 1,6 cm   A: 1,9 cm</p> <p>● Preto Art. n.º 1006569 21,00 EUR ○ Branco 1006570 21,00 EUR</p>	<p><b>Placa de reforço de calhas com conjunto de suspensão, haste de 1 m</b> Aço C: 12 cm   L: 2,7 cm</p> <p>● Preto Art. n.º 1006601 21,00 EUR ○ Branco 1006602 21,00 EUR</p>
<p><b>Conector flexível, elétrico, DALI</b> 16A máx.   Policarbonato (PC) C: 23 cm   L: 1,6 cm   A: 1,9 cm</p> <p>● Preto Art. n.º 1006573 29,00 EUR ○ Branco 1006574 29,00 EUR</p>	<p><b>Estrutura suspensa, haste de 1 m</b> Aço L: 2,9 cm</p> <p>● Preto Art. n.º 1006605 18,00 EUR ○ Branco 1006606 18,00 EUR</p>
<p><b>Caixa de transformador incl. alimentador de extremidade direita, DALI</b> Policarbonato (PC) C: 23,3 cm   L: 10,1 cm   A: 4,1 cm</p> <p>● Preto Art. n.º 1007137 35,00 EUR ○ Branco 1007138 35,00 EUR</p>	<p><b>Estrutura suspensa, cabo de aço de 3 m</b> Aço L: 2,9 cm</p> <p>● Preto Art. n.º 1006607 18,00 EUR ○ Branco 1006608 18,00 EUR</p>
<p><b>Caixa de transformador incl. alimentador de extremidade esquerdo, DALI</b> Policarbonato (PC) C: 23,3 cm   L: 10,1 cm   A: 4,1 cm</p> <p>● Preto Art. n.º 1007083 35,00 EUR ○ Branco 1007084 35,00 EUR</p>	<p><b>Grampo de fixação</b> Alumínio C: 3 cm   L: 2,72 cm   A: 1,05 cm</p> <p>● Preto Art. n.º 1006599 7,50 EUR ○ Branco 1006600 7,50 EUR</p>

1006635 + 1006729 475 + 469

NUMINOS® XS  
48V, DALI

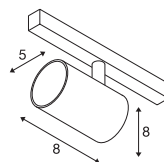
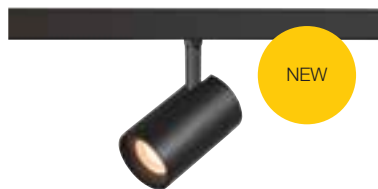

NUMINOS® S  
48V, DALI

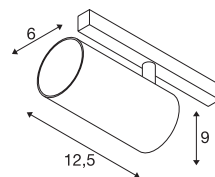



# NUMINOS® SPOT 48V



**XS** 48V | 200mA  
Potência total: 8,7W  
Material: alumínio / policarbonato (PC)

**S** 48V | 350mA  
Potência total: 16W  
Material: alumínio / policarbonato (PC)

		2700K	20°	640lm	1006651	175,00 EUR	100lm	1006705	185,00 EUR			
			40°	620lm	1006654	175,00 EUR				970lm	1006708	185,00 EUR
			55°	640lm	1006657	175,00 EUR				960lm	1006711	185,00 EUR
		3000K	20°	700lm	1006669	175,00 EUR	1060lm	1006723	185,00 EUR			
			40°	670lm	1006672	175,00 EUR				1030lm	1006726	185,00 EUR
			55°	690lm	1006675	175,00 EUR				1030lm	1006729	185,00 EUR
		2700K	20°	670lm	1006652	175,00 EUR	1020lm	1006706	185,00 EUR			
			40°	650lm	1006655	175,00 EUR				1050lm	1006709	185,00 EUR
			55°	670lm	1006658	175,00 EUR				1030lm	1006712	185,00 EUR
		3000K	20°	730lm	1006670	175,00 EUR	1120lm	1006724	185,00 EUR			
			40°	700lm	1006673	175,00 EUR				1120lm	1006727	185,00 EUR
			55°	720lm	1006676	175,00 EUR				1120lm	1006730	185,00 EUR
		2700K	20°	670lm	1006653	175,00 EUR	960lm	1006707	185,00 EUR			
			40°	650lm	1006656	175,00 EUR				1000lm	1006710	185,00 EUR
			55°	670lm	1006659	175,00 EUR				980lm	1006713	185,00 EUR
		3000K	20°	730lm	1006671	175,00 EUR	1050lm	1006725	185,00 EUR			
			40°	700lm	1006674	175,00 EUR				1050lm	1006728	185,00 EUR
			55°	720lm	1006677	175,00 EUR				1050lm	1006731	185,00 EUR
		2700K	20°	670lm	1006661	175,00 EUR	1020lm	1006715	185,00 EUR			
			40°	650lm	1006664	175,00 EUR				1050lm	1006718	185,00 EUR
			55°	670lm	1006667	175,00 EUR				1030lm	1006721	185,00 EUR
		3000K	20°	730lm	1006679	175,00 EUR	1120lm	1006733	185,00 EUR			
			40°	700lm	1006682	175,00 EUR				1120lm	1006736	185,00 EUR
			55°	720lm	1006685	175,00 EUR				1120lm	1006739	185,00 EUR
		2700K	20°	640lm	1006660	175,00 EUR	1000lm	1006714	185,00 EUR			
			40°	620lm	1006663	175,00 EUR				970lm	1006717	185,00 EUR
			55°	640lm	1006666	175,00 EUR				960lm	1006720	185,00 EUR
		3000K	20°	700lm	1006678	175,00 EUR	1060lm	1006732	185,00 EUR			
			40°	670lm	1006681	175,00 EUR				1030lm	1006735	185,00 EUR
			55°	690lm	1006684	175,00 EUR				1030lm	1006738	185,00 EUR
		2700K	20°	670lm	1006662	175,00 EUR	960lm	1006716	185,00 EUR			
			40°	650lm	1006665	175,00 EUR				1000lm	1006719	185,00 EUR
			55°	670lm	1006668	175,00 EUR				980lm	1006722	185,00 EUR
		3000K	20°	730lm	1006680	175,00 EUR	1050lm	1006734	185,00 EUR			
			40°	700lm	1006683	175,00 EUR				1050lm	1006737	185,00 EUR
			55°	720lm	1006686	175,00 EUR				1050lm	1006740	185,00 EUR



Artigo	Art. n.º	EUR
Difusor elíptico   XS		
○ Transparente	1005612	4,50
Difusor prismático   XS		
○ Transparente	1005613	5,30
Difusor fosco   XS		
○ Fosco	1005614	5,30
Difusor favo de mel   XS		
● Preto	1005615	8,35



Artigo	Art. n.º	EUR
Difusor elíptico   S		
○ Transparente	1004786	4,50
Difusor prismático   S		
○ Transparente	1004787	5,30
Difusor fosco   S		
○ Fosco	1004788	5,30
Difusor favo de mel   S		
● Preto	1004789	8,35

Estes projetores também estão disponíveis como variantes de 4000K, mediante pedido (exceto XS). Observe os diferentes prazos de entrega e quantidades mínimas para encomenda.

1006844 471

NUMINOS® XS  
48V, DALI

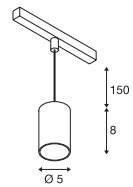

NUMINOS® S  
48V, DALI

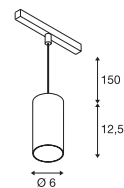



# NUMINOS® LUMINÁRIA SUSPensa 48V



**XS** 48V | 200mA  
Potência total: 8,7W  
Material: alumínio / policarbonato (PC)

**S** 48V | 350mA  
Potência total: 16W  
Material: alumínio / policarbonato (PC)

	2700K	20°	460lm	1006759	195,00 EUR		1000lm	1006813	205,00 EUR	
		40°	620lm	1006762	195,00 EUR		970lm	1006816	205,00 EUR	
		55°	640lm	1006765	195,00 EUR		960lm	1006819	205,00 EUR	
	3000K	20°	700lm	1006777	195,00 EUR		1060lm	1006831	205,00 EUR	
		40°	670lm	1006780	195,00 EUR		1030lm	1006834	205,00 EUR	
		55°	690lm	1006783	195,00 EUR		1030lm	1006837	205,00 EUR	
		2700K	20°	670lm	1006760		195,00 EUR	1020lm	1006814	205,00 EUR
			40°	650lm	1006763		195,00 EUR	1050lm	1006817	205,00 EUR
			55°	670lm	1006766		195,00 EUR	1030lm	1006820	205,00 EUR
3000K		20°	730lm	1006778	195,00 EUR	1120lm	1006832	205,00 EUR		
		40°	700lm	1006781	195,00 EUR	1120lm	1006835	205,00 EUR		
		55°	720lm	1006784	195,00 EUR	1120lm	1006838	205,00 EUR		
		2700K	20°	670lm	1006761	195,00 EUR	960lm	1006815	205,00 EUR	
			40°	650lm	1006764	195,00 EUR	1000lm	1006818	205,00 EUR	
			55°	670lm	1006767	195,00 EUR	980lm	1006821	205,00 EUR	
	3000K	20°	730lm	1006779	195,00 EUR	1050lm	1006833	205,00 EUR		
		40°	700lm	1006782	195,00 EUR	1050lm	1006836	205,00 EUR		
		55°	720lm	1006785	195,00 EUR	1050lm	1006839	205,00 EUR		
		2700K	20°	670lm	1006769	195,00 EUR	1020lm	1006823	205,00 EUR	
			40°	650lm	1006772	195,00 EUR	1050lm	1006826	205,00 EUR	
			55°	670lm	1006775	195,00 EUR	1030lm	1006829	205,00 EUR	
3000K		20°	730lm	1006787	195,00 EUR	1120lm	1006841	205,00 EUR		
		40°	700lm	1006790	195,00 EUR	1120lm	1006844	205,00 EUR		
		55°	720lm	1006793	195,00 EUR	1120lm	1006847	205,00 EUR		
		2700K	20°	620lm	1006771	195,00 EUR	1000lm	1006822	205,00 EUR	
			40°	640lm	1006768	195,00 EUR	970lm	1006825	205,00 EUR	
			55°	640lm	1006774	195,00 EUR	960lm	1006828	205,00 EUR	
	3000K	20°	700lm	1006786	195,00 EUR	1060lm	1006840	205,00 EUR		
		40°	670lm	1006789	195,00 EUR	1030lm	1006843	205,00 EUR		
		55°	690lm	1006792	195,00 EUR	1030lm	1006846	205,00 EUR		
		2700K	20°	670lm	1006770	195,00 EUR	960lm	1006824	205,00 EUR	
			40°	650lm	1006773	195,00 EUR	1000lm	1006827	205,00 EUR	
			55°	670lm	1006776	195,00 EUR	980lm	1006830	205,00 EUR	
3000K		20°	730lm	1006788	195,00 EUR	1050lm	1006842	205,00 EUR		
		40°	700lm	1006791	195,00 EUR	1050lm	1006845	205,00 EUR		
		55°	720lm	1006794	195,00 EUR	1050lm	1006848	205,00 EUR		



Artigo	Art. n.º	EUR
Difusor elíptico   XS		
● Transparente	1005612	4,50
Difusor prismático   XS		
● Transparente	1005613	5,30
Difusor fosco   XS		
○ Fosco	1005614	5,30
Difusor favo de mel   XS		
● Preto	1005615	8,35



Artigo	Art. n.º	EUR
Difusor elíptico   S		
● Transparente	1004786	4,50
Difusor prismático   S		
● Transparente	1004787	5,30
Difusor fosco   S		
○ Fosco	1004788	5,30
Difusor favo de mel   S		
● Preto	1004789	8,35

Estes projetores também estão disponíveis como variantes de 4000K, mediante pedido (exceto XS). Observe os diferentes prazos de entrega e quantidades mínimas para encomenda.

1006654 + 1006633 + 1006627 469 + 475 + 473







IN-LINE 22  
48V, opal, DALI



NEW

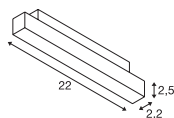

48V | 350mA  
Consumo de energia: 6W  
Potência total: 7,3W  
Material: alumínio



Down 540lm | 2700K  
570lm | 3000K

Variante	Art. n.º	EUR
● Preto 540lm   2700K	1006615	125,00
● Preto 570lm   3000K	1006617	125,00
○ Branco 540lm   2700K	1006616	125,00
○ Branco 570lm   3000K	1006618	125,00

IN-LINE 22  
48V, Darklight Reflector, DALI



NEW

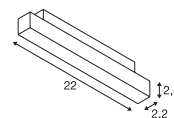
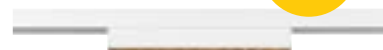

48V | 350mA  
Consumo de energia: 6W  
Potência total: 7,3W  
Material: alumínio / policarbonato (PC)



Down 580lm | 2700K  
610lm | 3000K

Variante	Art. n.º	EUR
● Preto 580lm   2700K	1006627	140,00
● Preto 610lm   3000K	1006629	140,00
○ Branco 580lm   2700K	1006628	140,00
○ Branco 610lm   3000K	1006630	140,00



[1006633](tel:1006633) + [1006654](tel:1006654) [475+469](tel:475469)





**IN-LINE 44**  
48V, opal, DALI



NEW

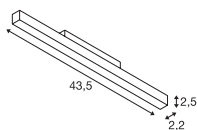
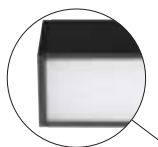

48V | 350mA  
Consumo de energia: 12W  
Potência total: 14W  
Material: alumínio / policarbonato (PC)



Down 1140lm | 2700K  
1180lm | 3000K

Variante	Art. n.º	EUR
● Preto 1140lm   2700K	1006621	184,00
● Preto 1180lm   3000K	1006623	184,00
○ Branco 1140lm   2700K	1006622	184,00
○ Branco 1180lm   3000K	1006624	184,00

**IN-LINE 44**  
48V, Darklight Reflector, DALI



NEW

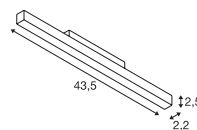

48V | 350mA  
Consumo de energia: 12W  
Potência total: 14W  
Material: alumínio



Down 1180lm | 2700K  
1230lm | 3000K

Variante	Art. n.º	EUR
● Preto 1180lm   2700K	1006633	199,00
● Preto 1230lm   3000K	1006635	199,00
○ Branco 1180lm   2700K	1006634	199,00
○ Branco 1230lm   3000K	1006636	199,00

1006682 + 1006648 469 + 477





### IN-LINE 24

48V, Move, Darklight Reflector, DALI



NEW

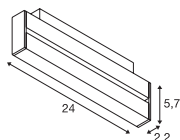

180°

48V | 350mA  
Consumo de energia: 6W  
Potência total: 7,3W  
Material: alumínio / policarbonato (PC)



Down 580lm | 2700K  
610lm | 3000K

Variante	Art. n.º	EUR
● Preto		
580lm   2700K	1006639	150,00
● Preto		
610lm   3000K	1006641	150,00
○ Branco		
580lm   2700K	1006640	150,00
○ Branco		
610lm   3000K	1006642	150,00

### IN-LINE 46

48V, Move, Darklight Reflector, DALI



NEW

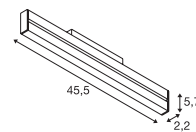

180°

48V | 350mA  
Consumo de energia: 12W  
Potência total: 14W  
Material: alumínio / policarbonato (PC)



Down 1180lm | 2700K  
1230lm | 3000K

Variante	Art. n.º	EUR
● Preto		
1180lm   2700K	1006645	209,00
● Preto		
1230lm   3000K	1006647	209,00
○ Branco		
1180lm   2700K	1006646	209,00
○ Branco		
1230lm   3000K	1006648	209,00

# CRIE O SEU CONJUNTO

---

Selecione a sua variante de calha eletrificada no comprimento certo, na cor desejada e com o tipo de instalação preferido. Decida sobre a variante de montagem encastrada ou uma das duas variantes salientes. Com as luminárias NUMINOS® e IN-LINE especialmente concebidas para o sistema de 48V da SLV, elas são particularmente flexíveis e enquadram perfeitamente o ambiente.

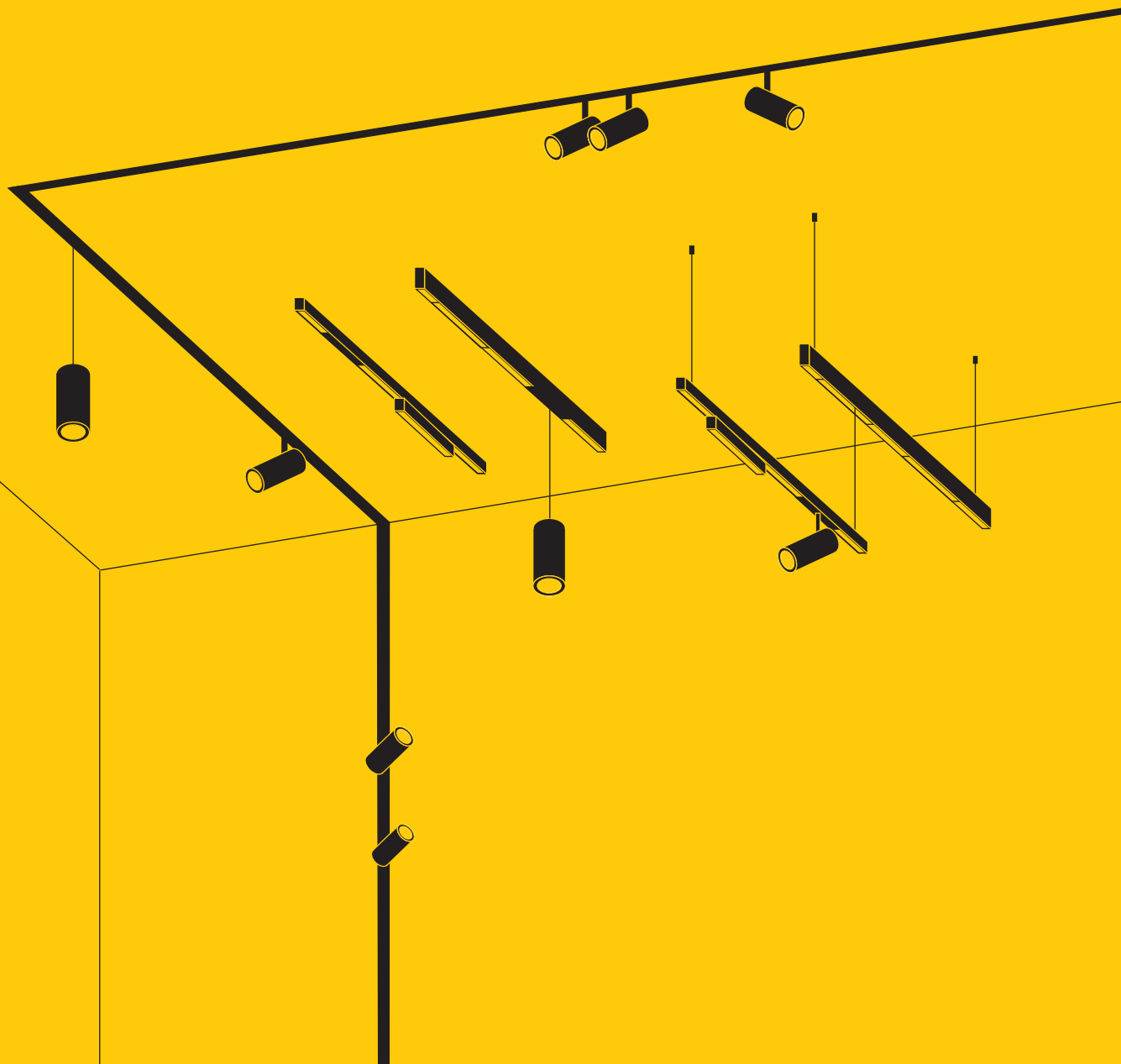

# SELECIONE A SUA CALHA ELETRIFICADA

CALHA ELETRIFICADA  
SALIENTE STANDARD

CALHA ELETRIFICADA  
SALIENTE EM PROFUNDIDADE

CALHA ELETRIFICADA DE  
MONTAGEM ENCASTRADA

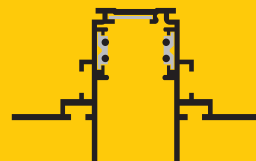
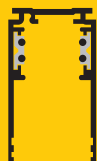

## SELECIONE O TIPO DE INSTALAÇÃO

SALIENTE

ENCASTRAR



Teto



Parede



Suspensa



Teto



Parede



## SELECIONE AS SUAS LUMINÁRIAS

NUMINOS®  
PROJETOR E LUMINÁRIA SUSPensa

IN-LINE, IN-LINE DARKLIGHT REFLECTOR  
E IN-LINE MOVE



## SELECIONE OS SEUS ACESSÓRIOS

DIVERSOS CONECTORES, COBERTURAS, SUSPENSÕES,  
FONTES DE ALIMENTAÇÃO E MUITO MAIS

139100 489







**SCKET**

ASMARÁ | 486



**SCKET**

TELESKOP | 486



**SCKET**

COSMIC | 487



**SCKET**

SYROS | 489



**SCKET**

SALUNA | 489



**LED**

DURNO | 489



**LED**

PLYTTA | 490



**LED**

NOBLO® SPOT | 491



**LED**

COMET LED | 491



**SCKET**

COMET | 491

TENSEO, Cabo de baixa tensão 4 mm<sup>2</sup>, 10 m



	10 m	10 m	10 m
Tensão máx. (V)	48	48	48
Intensidade máx. de corrente (A)	25	25	25
Cor	● Preto	○ Branco	○ Transparente
Material	Cobre/plástico	Cobre/plástico	Cobre/plástico
Diâmetro (cm)/Comprimento (cm)	0,4 / 1000	0,4 / 1000	0,4 / 1000
Art. n.º	1002602	1002603	1002604
EUR	29,25	29,25	29,25

TENSEO, Cabo de baixa tensão 4 mm<sup>2</sup>, 20 m



	20 m	20 m	20 m
Tensão máx.	48	48	48
Intensidade máx. de corrente (A)	25	25	25
Cor	● Preto	○ Branco	○ Transparente
Material	Cobre/plástico	Cobre/plástico	Cobre/plástico
Diâmetro (cm)/Comprimento (cm)	0,4 / 2000	0,4 / 2000	0,4 / 2000
Art. n.º	139030	139031	139024
EUR	48,75	48,75	48,75

TENSEO, Cabo de baixa tensão 4 mm<sup>2</sup>, 100 m

	100 m	100 m	100 m
Tensão máx. (V)	48	48	48
Intensidade máx. de corrente (A)	25	25	25
Cor	● Preto	○ Branco	○ Transparente
Material	Cobre/plástico	Cobre/plástico	Cobre/plástico
Diâmetro (cm)/Comprimento (cm)	0,4 / 10000	0,4 / 10000	0,4 / 10000
Art. n.º	139040	139041	139004
EUR	244,00	244,00	244,00

TENSEO, Cabo de baixa tensão 6 mm<sup>2</sup>, 20 m

	20 m	20 m	20 m
Tensão máx. (V)	48	48	48
Intensidade máx. de corrente (A)	25	25	25
Cor	● Preto	○ Branco	○ Transparente
Material	Cobre/plástico	Cobre/plástico	Cobre/plástico
Diâmetro (cm)/Comprimento (cm)	0,6 / 2000	0,6 / 2000	0,6 / 2000
Art. n.º	139050	139051	139026
EUR	58,00	58,00	58,00

TENSEO, Cabo de baixa tensão 6 mm<sup>2</sup>, 100 m



	100 m	100 m	100 m
Tensão máx. (V)	48	48	48
Intensidade máx. de corrente (A)	25	25	25
Cor	● Preto	○ Branco	○ Transparente
Material	Cobre/plástico	Cobre/plástico	Cobre/plástico
Diâmetro (cm)/Comprimento (cm)	0,6 / 10000	0,6 / 10000	0,6 / 10000
Art. n.º	139060	139061	139006
EUR	287,00	287,00	287,00



139131 489



**12V CA | 50VA convencional**

Aço/bronze  
A: 11 cm Ø: 11,1 cm

● Preto	Art. n.º	1002691	111,00 EUR
○ Branco		1002692	111,00 EUR
● Cromado		1002693	115,00 EUR



**12V CA | 105VA convencional**

Aço/bronze  
A: 11 cm Ø: 11,1 cm

○ Branco	Art. n.º	138981	135,00 EUR
● Cromado		138982	147,00 EUR



**12V CA | 210VA convencional**

Aço/bronze  
A: 11 cm Ø: 13,5 cm

○ Branco	Art. n.º	138991	204,00 EUR
● Cromado		138992	213,00 EUR



**Tensor de cabo**  
25A máx. | Bronze  
A: 11 cm Ø: 1 cm

● Preto	Art. n.º	181530	28,50 EUR
○ Branco		181531	28,50 EUR
● Cromado		181532	30,75 EUR



**Haste de suporte para parede**

Aço/bronze  
C: 3 cm Ø: 5 cm

● Preto	Art. n.º	186300	28,50 EUR
○ Branco		186301	28,50 EUR
● Cromado		186302	30,75 EUR



**Defletor 6 cm**

Aço/bronze  
A: 6 cm Ø: 5 cm

● Preto	Art. n.º	186330	24,50 EUR
○ Branco		186331	24,50 EUR
● Cromado		186332	28,50 EUR



**Defletor**

Aço/bronze  
A: 16 cm Ø: 5 cm

● Preto	Art. n.º	186340	28,50 EUR
○ Branco		186341	28,50 EUR
● Cromado		186342	30,75 EUR



**Suporte de parede 10 cm**

Aço/bronze  
A: 11,5 cm Ø: 5 cm, com dispositivo de fixação

● Preto	Art. n.º	186310	40,50 EUR
○ Branco		186311	40,50 EUR
● Cromado		186312	42,75 EUR



**Defletor de teto**

Aço/bronze  
A: 16 cm Ø: 5 cm

● Preto	Art. n.º	186640	92,00 EUR
○ Branco		186641	92,00 EUR
● Cromado		186642	99,00 EUR



**Alimentador**

25A máx. | Bronze  
A: 1,8 cm Ø: 1 cm

● Preto	Art. n.º	186350	12,20 EUR
○ Branco		186351	12,20 EUR
● Cromado		186352	13,70 EUR



**União isolante**

25A máx. | Alumínio/plástico  
C: 6,4 cm Ø: 1 cm

● Preto	Art. n.º	186360	22,75 EUR
○ Branco		186361	22,75 EUR
● Cromado		186362	24,50 EUR



**Espaçador**

Alumínio  
L: 9 cm Ø: 1,25 cm

● Preto	Art. n.º	1002700	46,50 EUR
○ Branco		1002701	46,50 EUR
● Cromado		1002702	56,00 EUR



**Espaçador elétrico**

25A máx. | Bronze  
A: 9 cm Ø: 1,25 cm

● Preto	Art. n.º	1002703	56,00 EUR
○ Branco		1002704	56,00 EUR
● Cromado		1002705	62,00 EUR



**Conjunto de suspensão 2 m**

Aço/alumínio  
L: 18,6 cm Ø: 1,25 cm

● Preto	Art. n.º	1002697	40,50 EUR
○ Branco		1002698	40,50 EUR
● Cromado		1002699	42,75 EUR



139071 486

## ASMARA LV, QR-C51

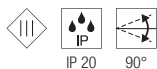
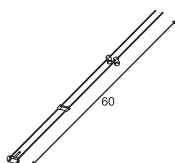

12V ~50Hz  
Material: aço inoxidável



Casquilho: 1xGX5.3

Variante	Art. n.º	EUR
● Preto	139070	28,25
○ Branco	139071	28,25
● Cromado	139072	30,75



LED GU5.3 | 5,8W | 36°  
2700K | 450lm | EE=G  
6kWh/1000h

Art. N.º: 1001574 | 35,00 EUR



## TELESKOP LV, QR-C51

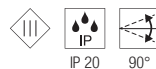

12V ~50Hz  
Material: aço

- Telescópio ajustável de 21 a 51 cm



Casquilho: 1xGX5.3

Variante	Art. n.º	EUR
● Preto	139080	33,75
○ Branco	139081	33,75
● Cromado	139082	36,75



LED GU5.3 | 5,8W | 36°  
2700K | 450lm | EE=G  
6kWh/1000h

Art. N.º: 1001574 | 35,00 EUR





## COSMIC LV, QR-C51

139090 487

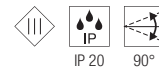
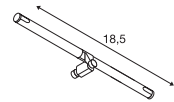

12V ~50Hz  
Material: aço/bronze

**SOCKET  
INSIDE** <35  
W

Casquilho: 1xGX5.3

Variante	Art. n.º	EUR
● Preto	139090	40,25
○ Branco	139091	40,25
● Cromado	139092	42,50



LED GU5.3 | 5,8W | 36°  
2700K | 450lm | EE=G  
6kWh/1000h



Art. N.º: 1001574 | 35,00 EUR

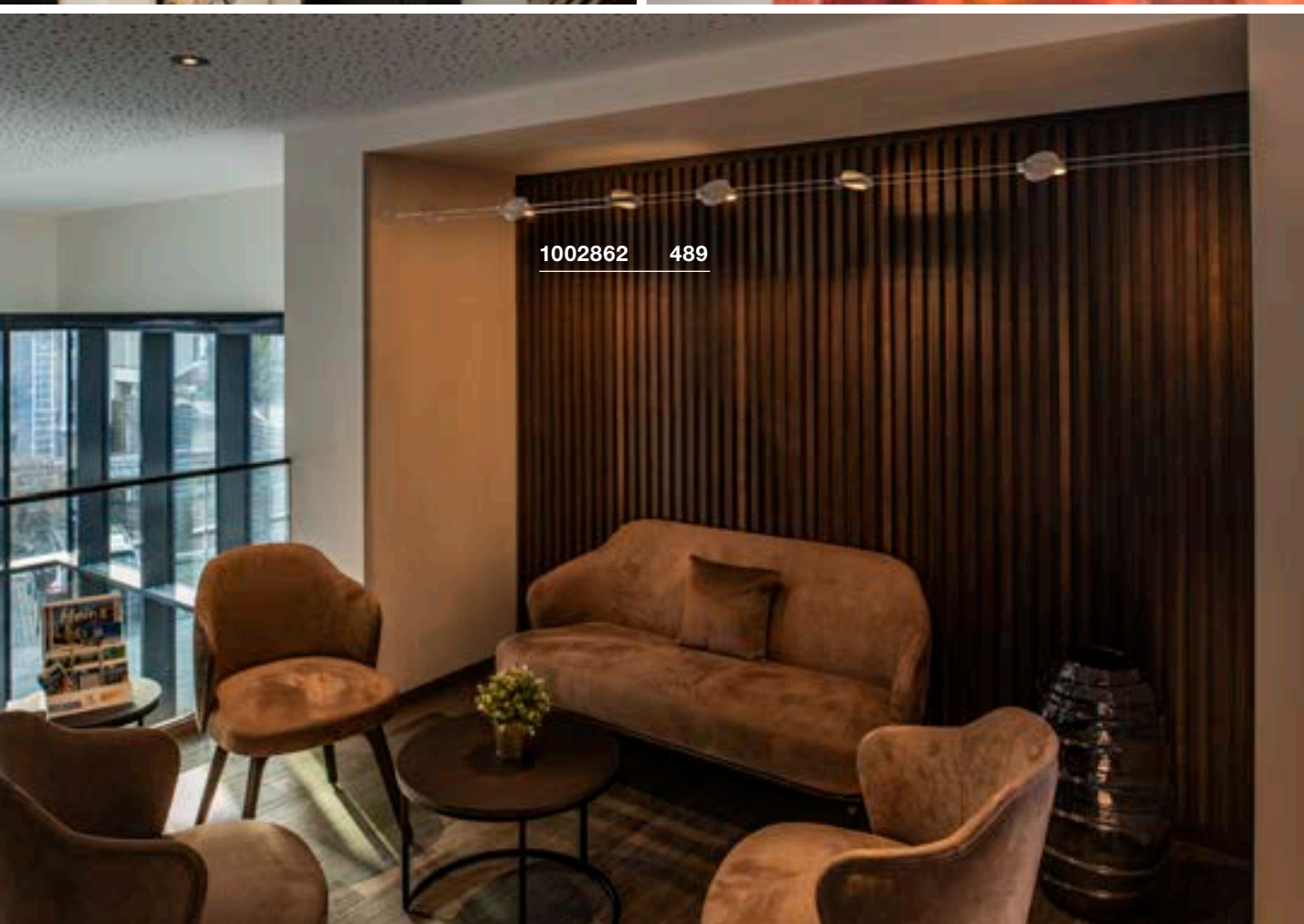
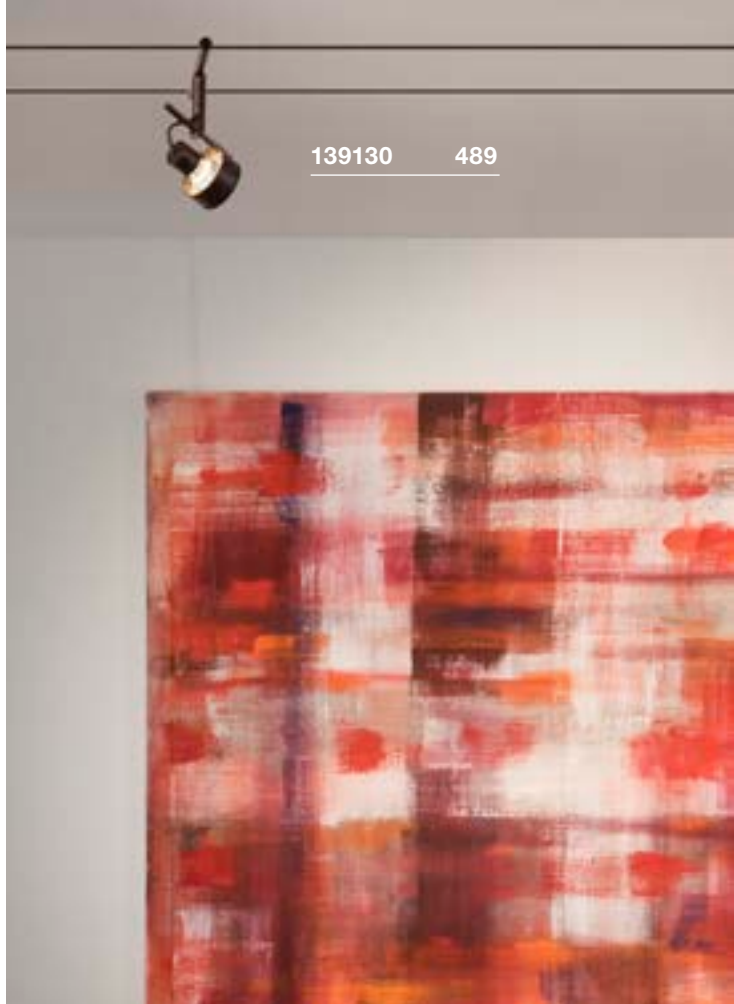





**SYROS**  
LV, QR-C51

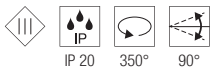
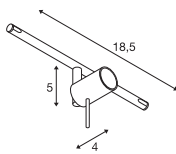

12V ~50Hz  
Material: aço



Casquilho: 1xGX5.3

Variante	Art. n.º	EUR
● Preto	139100	55,00
○ Branco	139101	55,00
● Cromado	139102	62,00



LED GU5.3 | 5,8W | 36°  
2700K | 450lm | EE=G  
6kWh/1000h

Art. N.º: 1001574 | 35,00 EUR



**SALUNA**  
LV, QR-C51

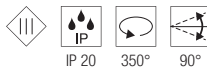
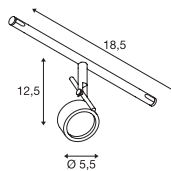

12V ~50Hz  
Material: aço/bronze



Casquilho: 1xGX5.3

Variante	Art. n.º	EUR
● Preto	139130	72,00
○ Branco	139131	72,00
● Cromado	139132	78,00



LED GU5.3 | 5,8W | 36°  
2700K | 450lm | EE=G  
6kWh/1000h

Art. N.º: 1001574 | 35,00 EUR



**DURNO**  
LV

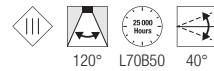
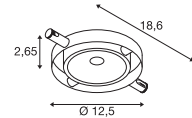

12V ~50Hz  
Consumo de energia: 6W  
Material: alumínio/aço inoxidável



Down

360lm | 2700K

Variante	Art. n.º	EUR
● Preto	1002861	82,00
○ Branco	1002862	82,00
● Cromado/aço inoxidável	1002863	86,00

1002864 490

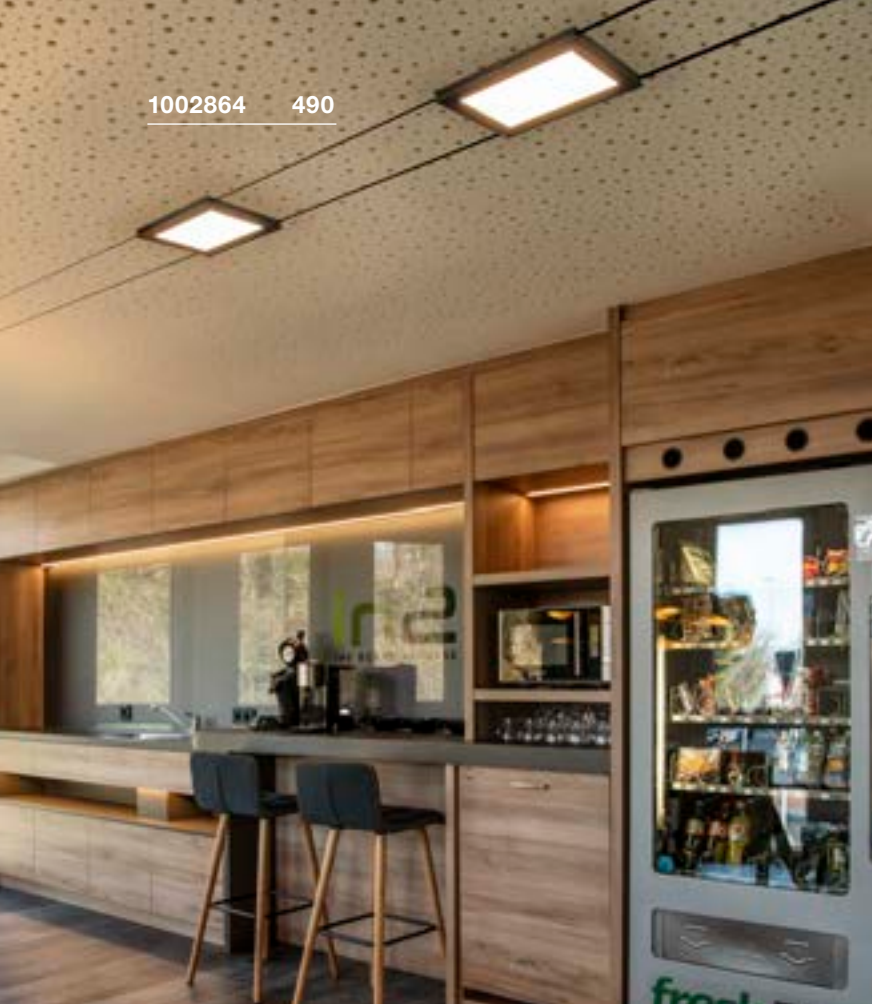

## PLYTTA LV

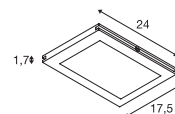

1002690 491

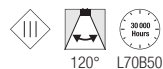

12V ~50Hz  
Consumo de energia: 9,8W  
Material: alumínio/plástico



Down

750lm | 2700K

Variante	Art. n.º	EUR
● Preto IRC80	1002864	65,00
○ Branco IRC90	1002865	65,00
● Cromado IRC90	1002866	70,00



## NOBLO® SPOT LV, Rope Track

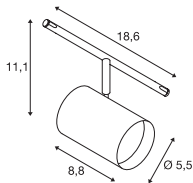

12V ~50Hz  
Consumo de energia: 8,5W  
Material: alumínio



Down 420lm | 2700K  
450lm

Variante	Art. n.º	EUR
● Preto 420lm	1002694	80,00
○ Branco 450lm	1002695	80,00
● Cromado 450lm	1002696	85,00

## COMET LED LV

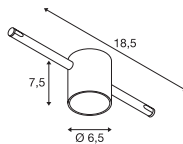

12V ~50Hz  
Consumo de energia: 6,6W  
Material: alumínio/vidro



Down 410lm | 2700K

Variante	Art. n.º	EUR
● Cromado/fosco	1002690	83,00

## COMET LV, QR-C51

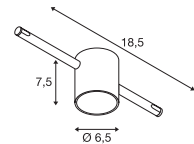

12V ~50Hz  
Material: bronze



Casquilho: 1xGU5.3

Variante	Art. n.º	EUR
● Preto	139120	55,00
○ Branco	139121	55,00
● Cromado	139122	62,00



LED GU5.3 | 5,8W | 36°  
2700K | 450lm | EE=G  
6kWh/1000h

Art. N.º: 1001574 | 35,00 EUR



1007354 503





NEW

**LED**  
NOBLO® SPOT | 501



NEW

**LED**  
NOBLO® SPOT | 501



NEW

**LED**  
NOBLO® SPOT | 503



NEW

**LED**  
NOBLO® SPOT | 503



NEW

**SCKET**  
ASTO TUBE | 505

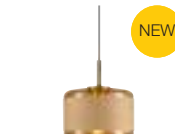

NEW

**SCKET**  
PANTILO  
ROPE 19 | 505



**LED**  
HELIA 50 TRACK | 507



**LED**  
PANEL TRACK | 507



**LED**  
PANEL TRACK | 507



**SCKET**  
PARA CONE GL | 508



**SCKET**  
PARA CONE GL | 508



**SCKET**  
PARA CONE 14 | 509



**SCKET**  
PARA CONE 14 | 509



**SCKET**  
TONGA® | 511



**SCKET**  
LIGHT EYE® 90 | 511



**SCKET**  
LIGHT EYE® 150 | 511



**SCKET**  
FORCHINI M 40  
TRACK | 512



**SCKET**  
PURI TRACK | 513



**SCKET**  
PURI TRACK | 513



**SCKET**  
PURI TRACK | 515



**SCKET**  
AVO TRACK | 515



**LED**  
ENOLA C TRACK | 516



**LED**  
ENOLA C TRACK | 517



**SCKET**  
ENOLA B TRACK | 517



**SCKET**  
ENOLA B | 517



**SCKET**  
BIMA | 519



**SCKET**  
BIMA | 519



**LED**  
KALU TRACK | 520



**SCKET**  
KALU TRACK | 520



**SCKET**  
EURO SPOT  
TRACK | 521



**SCKET**  
ALTRA DICE  
TRACK | 521

1000713 511



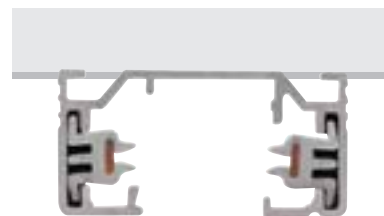

# MONOFÁSICO

## CALHA ELETRIFICADA SALIENTE



	1 m	1 m	1 m
Tensão nominal (V)	220-240V ~50/60Hz	250V ~50/60Hz	220-240V ~50/60Hz
Intensidade máx. de corrente (A)	16	16	16
Cor	● Preto	○ Branco	● Cinzento
Material	Alumínio	Alumínio	Alumínio
C x L x A (cm)	100 x 3,5 x 1,8	100 x 3,5 x 1,8	100 x 3,5 x 1,8
Art. n.º	143010	143011	143012
EUR	35,50	35,50	35,50

	2 m	2 m	2 m
Tensão nominal (V)	220-240V ~50/60Hz	250V ~50/60Hz	220-240V ~50/60Hz
Intensidade máx. de corrente (A)	16	16	16
Cor	● Preto	○ Branco	● Cinzento
Material	Alumínio	Alumínio	Alumínio
C x L x A (cm)	200 x 3,5 x 1,8	200 x 3,5 x 1,8	200 x 3,5 x 1,8
Art. n.º	143020	143021	143022
EUR	67,00	67,00	67,00

	3 m	3 m	3 m
Tensão nominal (V)	250V ~50/60Hz	250V ~50/60Hz	250V ~50/60Hz
Intensidade máx. de corrente (A)	16	16	16
Cor	● Preto	○ Branco	● Cinzento
Material	Alumínio	Alumínio	Alumínio
C x L x A (cm)	300 x 3,5 x 1,8	300 x 3,5 x 1,8	300 x 3,5 x 1,8
Art. n.º	1002151	1002152	1002153
EUR	100,00	100,00	100,00

# CALHA MONOFÁSICA

Calha eletrificada saliente  
Guia de planeamento e visão geral de acessórios

Vista de cima dos componentes  
no lado da montagem

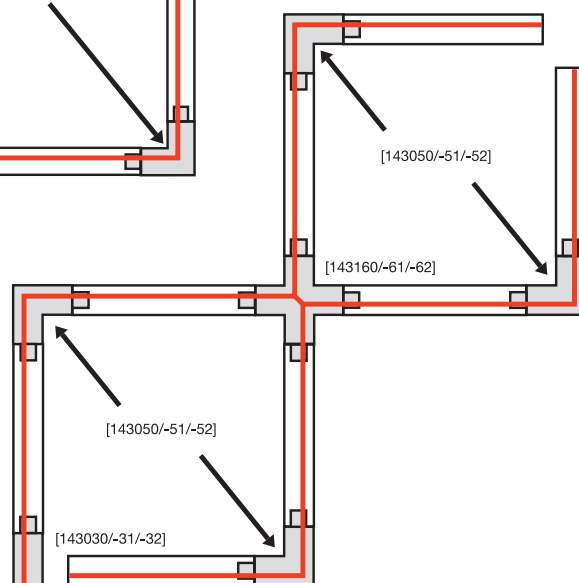
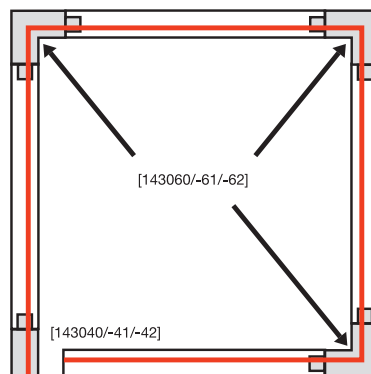
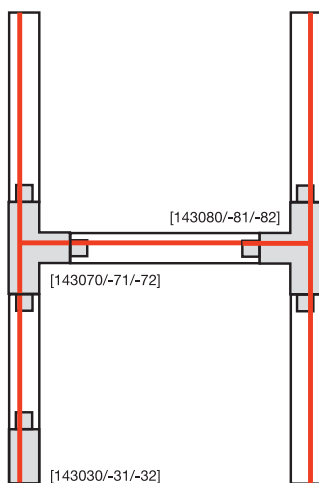
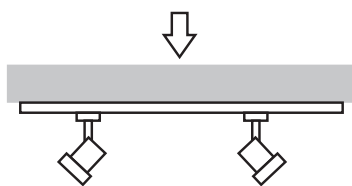





**Alimentador, terra esquerda**  
16A máx. | Policarbonato (PC)  
C: 6,5 cm | L: 3,5 cm | A: 1,8 cm

● Preto	Art. n.º	143030	9,35 EUR
○ Branco		143031	9,35 EUR
● Cinzento		143032	9,35 EUR



**Estabilizador, conector longitudinal comprido**  
Aço  
C: 19,7 cm | L: 3,2 cm | A: 1,3 cm  
Para reforço ao instalar várias calhas eletrificadas com suspensão para teto (1002845)

● Níquel	Art. n.º	143151	7,10 EUR
----------	----------	--------	----------



**Alimentador, terra direita**  
16A máx. | Policarbonato (PC)  
C: 6,5 cm | L: 3,5 cm | A: 1,8 cm

● Preto	Art. n.º	143040	9,35 EUR
○ Branco		143041	9,35 EUR
● Cinzento		143042	9,35 EUR



**Estabilizador, ligador em L comprido**  
Aço  
C: 11,5 cm | L: 11,5 cm | A: 0,5 cm  
Para reforço ao instalar várias calhas eletrificadas com suspensão para teto (1002845)

● Níquel	Art. n.º	143152	8,25 EUR
----------	----------	--------	----------



**Conectores longitudinais com opção de alimentação**  
16A máx. | Policarbonato (PC)

C: 17,2 cm   L: 3,5 cm   A: 1,8 cm			
● Preto	Art. n.º	143100	17,50 EUR
○ Branco		143101	17,50 EUR
● Cinzento		143102	17,50 EUR



**Estabilizador de conector em X**  
Aço  
C: 19,7 cm | L: 19,7 cm | A: 0,5 cm  
Para reforço ao instalar várias calhas eletrificadas com suspensão para teto (1002845).

● Cinzento	Art. n.º	143169	12,50 EUR
------------	----------	--------	-----------



**Conector longitudinal, elétrico**  
16A máx. | Policarbonato (PC)  
C: 6,4 cm | L: 3,5 cm | A: 1,8 cm

● Preto	Art. n.º	143090	7,10 EUR
○ Branco		143091	7,10 EUR
● Cinzento		143092	7,10 EUR



**Adaptador monofásico**  
6 A máx. | Policarbonato (PC)  
C: 8,5 cm | L: 3,5 cm | A: 3,2 cm

● Preto	Art. n.º	143120	15,00 EUR
○ Branco		143121	15,00 EUR
● Cinzento		143124	15,00 EUR



**Ligador em L, terra interior**  
16A máx. | Policarbonato (PC)  
C: 10,4 cm | L: 10,4 cm | A: 1,8 cm

● Preto	Art. n.º	143060	16,40 EUR
○ Branco		143061	16,40 EUR
● Cinzento		143062	16,40 EUR



**Adaptador monofásico com ganchos**  
6 A máx. | Policarbonato (PC)  
C: 8,5 cm | L: 3,5 cm | A: 7,4 cm

● Preto	Art. n.º	143170	15,00 EUR
○ Branco		143171	15,00 EUR
● Cinzento		143172	15,00 EUR



**Ligador em L, terra exterior**  
16A máx. | Policarbonato (PC)  
C: 10,4 cm | L: 10,4 cm | A: 1,8 cm

● Preto	Art. n.º	143050	16,40 EUR
○ Branco		143051	16,40 EUR
● Cinzento		143052	16,40 EUR



**Cobertura**  
Policarbonato (PC)  
C: 200 cm | L: 1,8 cm | A: 0,75 cm

● Preto	Art. n.º	1004783	21,00 EUR
○ Branco		1004785	21,00 EUR
● Cinzento		1004784	21,00 EUR



**Conector em T, terra exterior, esquerda**  
16A máx. | Policarbonato (PC)  
C: 17,2 cm | L: 10,4 cm | A: 1,8 cm

● Preto	Art. n.º	143070	20,75 EUR
○ Branco		143071	20,75 EUR
● Cinzento		143072	20,75 EUR



**Tampa (2 un.)**  
Policarbonato (PC)  
C: 0,4 cm | L: 3,5 cm | A: 1,8 cm

● Preto	Art. n.º	143130	4,40 EUR
○ Branco		143131	4,40 EUR
● Cinzento		143132	4,40 EUR



**Conector em T, terra exterior, direita**  
16A máx. | Policarbonato (PC)  
C: 17,2 cm | L: 10,4 cm | A: 1,8 cm

● Preto	Art. n.º	143080	20,75 EUR
○ Branco		143081	20,75 EUR
● Cinzento		143082	20,75 EUR

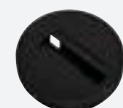

**Roseta para teto**  
6 A máx. | Policarbonato (PC)  
A: 2,5 cm Ø: 11,5 cm

● Preto	Art. n.º	143380	20,75 EUR
○ Branco		143381	20,75 EUR
● Cinzento		143382	20,75 EUR



**Conector em X**  
16A máx. | Policarbonato (PC)  
C: 9,5 cm | L: 17,2 cm | A: 1,8 cm

● Preto	Art. n.º	143160	31,25 EUR
○ Branco		143161	31,25 EUR
● Cinzento		143162	31,25 EUR

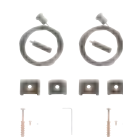

**Suspensão de cabos de aço (2 un.)**  
Aço inoxidável/bronze  
C: 500 cm

● Níquel	Art. n.º	1002845	41,75 EUR
----------	----------	---------	-----------



**Conector flex.**  
16A máx. | Policarbonato (PC)  
C: 16,4 cm | L: 3,5 cm | A: 1,8 cm

● Preto	Art. n.º	143110	17,50 EUR
○ Branco		143111	17,50 EUR
● Cinzento		143112	17,50 EUR

143580 507





# CALHA MONOFÁSICA

Calha eletrificada de montagem encastrada e acessórios adequados

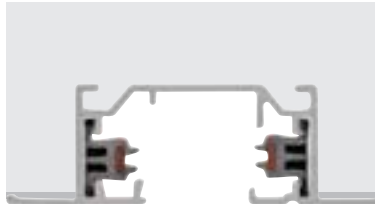

	<b>2 m</b>
Tensão nominal (V)	250V ~50/60Hz
Intensidade máx. de corrente (A)	16
Cor	<input type="radio"/> Branco
Material	Alumínio
C x L x A (cm)	200 x 5,5 x 1,8
Art. n.º	<b>143221</b>
EUR	<b>74,00</b>



**Alimentador, terra esquerda**  
16A máx. | Plástico  
C: 10,8 cm | L: 5,5 cm | A: 2 cm

Branco    Art. n.º **143231**    **13,90 EUR**



**Tampa**  
Plástico  
C: 2,7 cm | L: 5,5 cm | A: 1,8 cm

Branco    Art. n.º **143281**    **7,10 EUR**



**Alimentador, terra direita**  
16A máx. | Plástico  
C: 10,8 cm | L: 5,5 cm | A: 2 cm

Branco    Art. n.º **143241**    **13,90 EUR**



**Suporte de retenção**  
Aço  
C: 7,5 cm | L: 1,5 cm | A: 4 cm

Níquel    Art. n.º **143230**    **3,80 EUR**



**Conectores longitudinais incl. reforço longitudinal**  
16A máx. | Plástico/Aço  
C: 6,5 cm | L: 1,8 cm | A: 1,7 cm

Branco    Art. n.º **143271**    **13,90 EUR**



**Adaptador monofásico com ganchos**  
6A máx. | Policarbonato (PC)  
C: 8,5 cm | L: 3,5 cm | A: 7,4 cm

Preto    Art. n.º **143170**    **15,00 EUR**  
 Branco    **143171**    **15,00 EUR**  
 Cinzento    **143172**    **15,00 EUR**



**Ligador em L, terra interior**  
16A máx. | Plástico  
C: 11,2 cm | L: 11,2 cm | A: 2 cm

Branco    Art. n.º **143261**    **20,75 EUR**



**Adaptador monofásico**  
6A máx. | Policarbonato (PC)  
C: 8,5 cm | L: 3,5 cm | A: 3,2 cm

Preto    Art. n.º **143120**    **15,00 EUR**  
 Branco    **143121**    **15,00 EUR**  
 Cinzento    **143124**    **15,00 EUR**



**Ligador em L, terra exterior**  
16A máx. | Plástico  
C: 11,2 cm | L: 11,2 cm | A: 2 cm

Branco    Art. n.º **143251**    **20,75 EUR**

1007639 501





**NOBLO® SPOT**  
Monof., Triple Track Set

**NOBLO® SPOT**  
Monof., PHASE

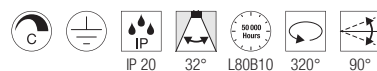
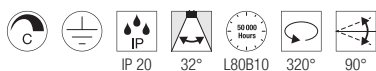
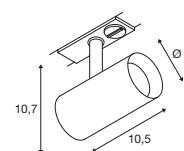
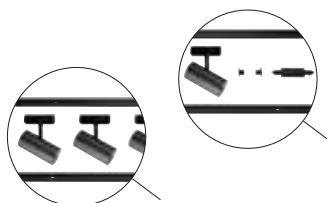

220-240V ~50/60Hz | 150mA  
Potência total: 19W  
Material: alumínio

220-240V ~50/60Hz | 150mA  
Potência total: 6,2W  
Material: alumínio/polycarbonato (PC)



Down 2250lm | 2700K



Down 740lm | 2700K

Variante	Art. n.º	EUR
● Preto	1007673	255,00
○ Branco	1007674	255,00

Variante	Art. n.º	EUR
● Preto	1007638	70,00
○ Branco	1007639	70,00
● Cinzento	1007640	70,00

1007352 503





### NOBLO® SPOT Monof., PHASE

### NOBLO® SPOT Monof., PHASE

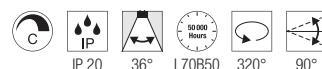
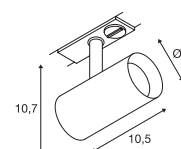
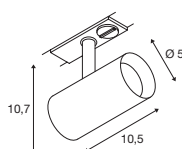

220-240V ~50/60Hz | 150mA  
Potência total: 6,2W  
Material: alumínio/policarbonato (PC)

220-240V ~50/60Hz | 350mA  
Potência total: 8,4W  
Material: alumínio/policarbonato (PC)



Down 750lm | 3000K

Down 30lm | 2000K - 450lm | 3000K

Variante	Art. n.º	EUR
● Preto	1007641	70,00
○ Branco	1007642	70,00
● Cinzento	1007643	70,00

Variante	Art. n.º	EUR
● Preto	1007352	85,00
○ Branco	1007353	85,00
● Cinzento	1007354	85,00

1006445 505







### ASTO TUBE Monof., GU10



NEW

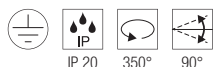
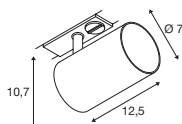

220-240V ~50/60Hz  
Material: alumínio



Casquilho: 1xGU10

Variante	Art. n.º	EUR
● Preto	1006445	70,00
○ Branco	1006446	70,00



LED GU10 51mm | 6W | 38°  
2700K | 450lm | EE=F  
6kWh/1000h



Art. N.º: 1005077 | 7,50 EUR

### ASTO TUBE Refletor decorativo



NEW

A: 3,95 cm  
Ø: 6,75 cm  
Material: policarbonato (PC)

Variante	Art. n.º	EUR
● Preto/cromado	1007190	4,00
● Dourado	1006450	4,00
● Cromado	1006449	4,00
● Cobre	1006451	4,00

### PANTILHO ROPE 19 PD, E27



NEW

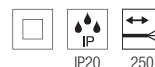
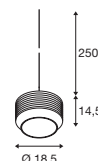

200-240V ~50/60Hz  
Material: vidro / aço / cânhamo

- Extremidade do cabo aberta



Casquilho: 1xE27 Máx. Ø: 10 cm | C: 11 cm

Variante	Art. n.º	EUR
● Âmbar/dourado	1007597	199,00
● Antracite/prateado	1007596	199,00



A60 | 7,5W | 180°  
2700K | 720lm | EE=F  
8kWh/1000h



Art. N.º: 1005305 | 19,00 EUR

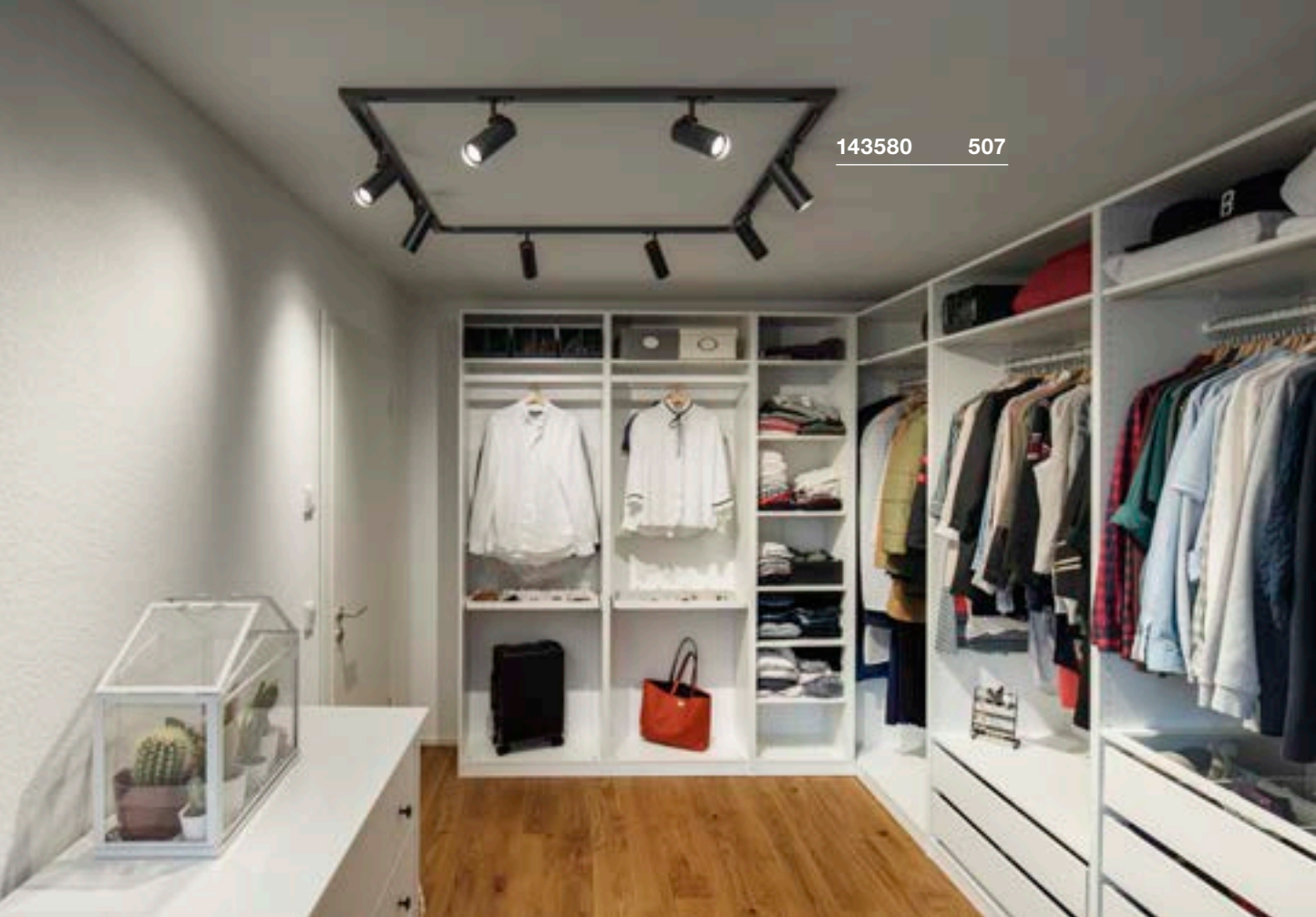



**HELIA 50 TRACK**  
Monof.

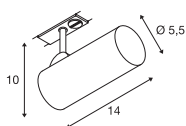

220-240V ~50/60Hz | 500mA  
Potência total: 11W  
Material: alumínio



Down 810lm | 880lm | 3000K

Variante	Art. n.º	EUR
● Preto		
810lm	<b>143580</b>	<b>90,00</b>
○ Branco		
880lm	<b>143581</b>	<b>90,00</b>

**PANEL TRACK**  
Monof., quadrado

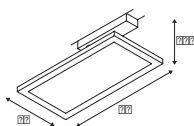

220-240V ~50/60Hz | 450mA  
Potência total: 18W  
Material: policarbonato (PC)/aço



Down 1800lm | 3000K

Variante	Art. n.º	EUR
● Preto	<b>1004933</b>	<b>96,00</b>
○ Branco	<b>1004934</b>	<b>96,00</b>

**PANEL TRACK**  
Monof., redondo

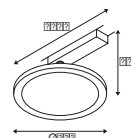

220-240V ~50/60Hz | 450mA  
Potência total: 18W  
Material: policarbonato (PC)/aço



Down 1800lm | 3000K

Variante	Art. n.º	EUR
● Preto	<b>1004935</b>	<b>96,00</b>
○ Branco	<b>1004936</b>	<b>96,00</b>

PARA CONE GL  
Monof., GU10

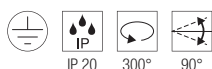
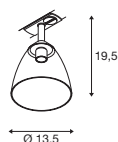

220-240V ~50/60Hz  
Material: alumínio/vidro



Casquilho: 1xGU10

Variante	Art. n.º	EUR
● Preto	1006155	89,00
○ Branco	1006156	89,00

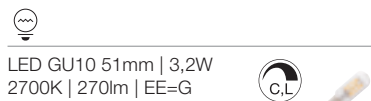

Art. N.º: 1006321 | 48,00 EUR

PARA CONE GL  
PD, GU10

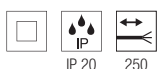
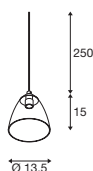

220-240V ~50/60Hz  
Material: alumínio/vidro



Casquilho: 1xGU10

Variante	Art. n.º	EUR
● Preto	1006159	84,00
○ Branco	1006160	84,00



Art. N.º: 1006321 | 48,00 EUR



Artigo	Art. n.º	EUR
Adaptador monof.		
● Preto	143120	15,00
○ Branco	143121	15,00
● Cinzento	143124	15,00

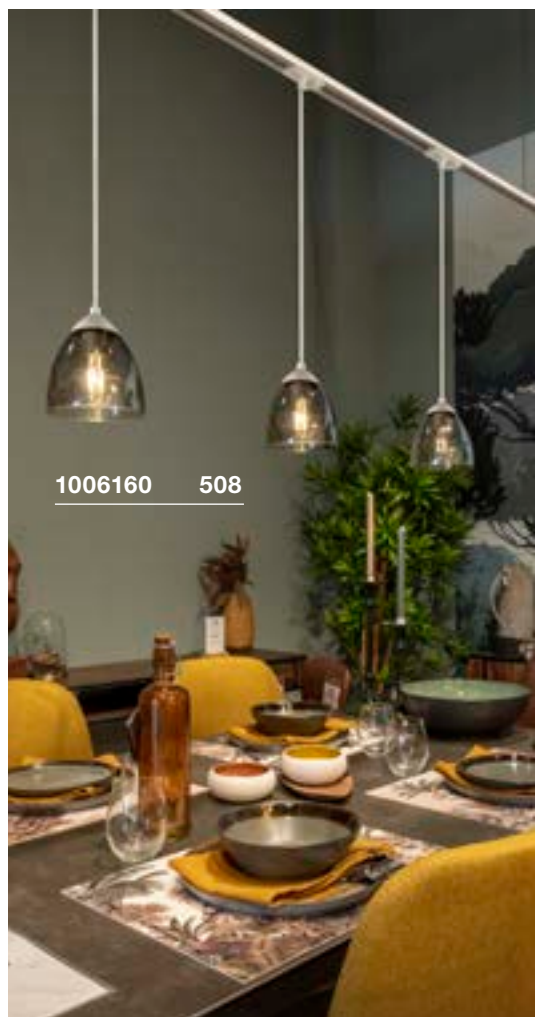

1006160 508



1006155 508

PARA CONE 14  
Monof., QPAR51

PARA CONE 14  
Monof., PD, QPAR51

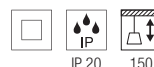
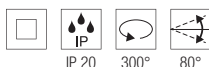
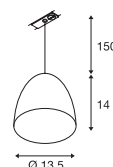
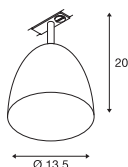

220-240V ~50/60Hz  
Material: aço

220-240V ~50/60Hz  
Material: alumínio

- Cabo em tecido
- Versão preto/dourado com refletor dourado
- Todas as outras versões com refletor branco



1002875 509



Casquilho: 1xGU10

Casquilho: 1xGU10

Variante	Art. n.º	EUR
● Preto	1002873	86,00
○ Branco	1002874	86,00
● Cobre	1002875	89,00

Variante	Art. n.º	EUR
● Preto	143990	117,00
○ Branco	143991	117,00
● Cobre	1001968	124,00



LED GU10 51mm | 3,2W  
2700K | 270lm | EE=G



Art. N.º: 1006321 | 48,00 EUR



LED GU10 51mm | 3,2W  
2700K | 270lm | EE=G



Art. N.º: 1006321 | 48,00 EUR



143594

511



144011

511



1000713

511



**TONGA®**  
Monof., PD, E14

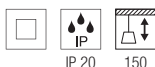
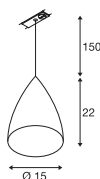

220-240V ~50/60Hz  
Material: alumínio/vidro



Casquilho: 1xE14 Máx. Ø: 5,1 cm | C: 13 cm

Variante	Art. n.º	EUR
● Cinzento/leitoso	143594	129,00



C35 | 4,2W | 320°  
2700K | 350lm | EE=G  
5kWh/1000h



Art. N.º: 1005285 | 8,50 EUR

**LIGHT EYE® 90**  
Monof., QPAR51

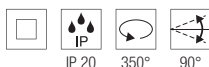
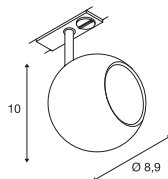

230V ~50/60Hz  
Material: aço



Casquilho: 1xGU10

Variante	Art. n.º	EUR
● Preto	144010	84,00
○ Branco	144011	84,00
● Cobre	144019	95,00



LED GU10 51mm | 6W | 36°  
2200-2700K | 360lm | EE=G  
6kWh/1000h



Art. N.º: 1005273 | 9,99 EUR

**LIGHT EYE® 150**  
Monof., PD, QPAR111

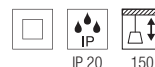
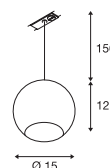

220-240V ~50/60Hz  
Material: aço



Casquilho: 1xGU10

Variante	Art. n.º	EUR
● Preto	1000713	132,00
○ Branco	143621	132,00



LED GU10 51mm | 6W | 38°  
2700K | 450lm | EE=F  
6kWh/1000h



Art. N.º: 1005077 | 7,50 EUR

FORCHINI M 40 TRACK  
Monof., E27

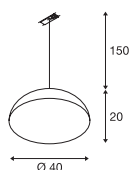

220-240V ~50/60Hz  
Material: alumínio/aço

- Adaptador de luminária suspensa na cor cinzento prateado [143930]/preto [143932]

**SOCKET INSIDE** <40 W

Casquilho: 1xE27 Máx. Ø: 6,8 cm | C: 15,2 cm

Variante	Art. n.º	EUR
● Preto/dourado	143930	233,00
● Preto/dourado	143932	233,00



A60 | 7,5W | 180°  
2700K | 720lm | EE=F  
8kWh/1000h



Art. N.º: 1005305 | 19,00 EUR



143932 512



1001868 513





**PURI TRACK**  
Monof., Triple Track Set

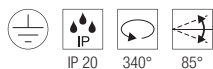
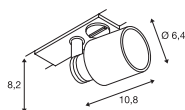

220-240V ~50/60Hz  
Potência total: 4,3W  
Material: alumínio

- Constituído por calha eletrificada 2 x 1 m.  
1 Conector longitudinal com alimentação.  
1 x 2 tampas.  
3x Cabeça da luminária Puri.  
3x Lâmpada LED GU10.  
3x Anel decorativo para GU10

**PURI TRACK**  
Monof., QPAR51

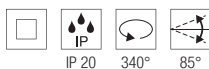

220-240V ~50/60Hz  
Material: alumínio/plástico



Casquilho: 1xGU10

Variante	Art. n.º	EUR
● Preto	1001868	45,00
○ Branco	1001869	45,00



LED GU10 51mm | 6W | 38°  
2700K | 450lm | EE=F  
6kWh/1000h



Art. N.º: 1005077 | 7,50 EUR

**PURI TRACK**  
Monof., QPAR51

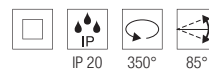
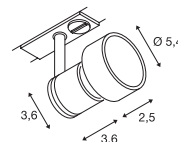

220-240V ~50/60Hz  
Material: alumínio/policarbonato (PC)



Casquilho: 1xGU10

Variante	Art. n.º	EUR
● Preto	143390	34,00
○ Branco	143391	34,00
● Cinzento	143392	34,00



LED GU10 51mm | 6W | 38°  
2700K | 450lm | EE=F  
6kWh/1000h



Art. N.º: 1005075 | 7,50 EUR

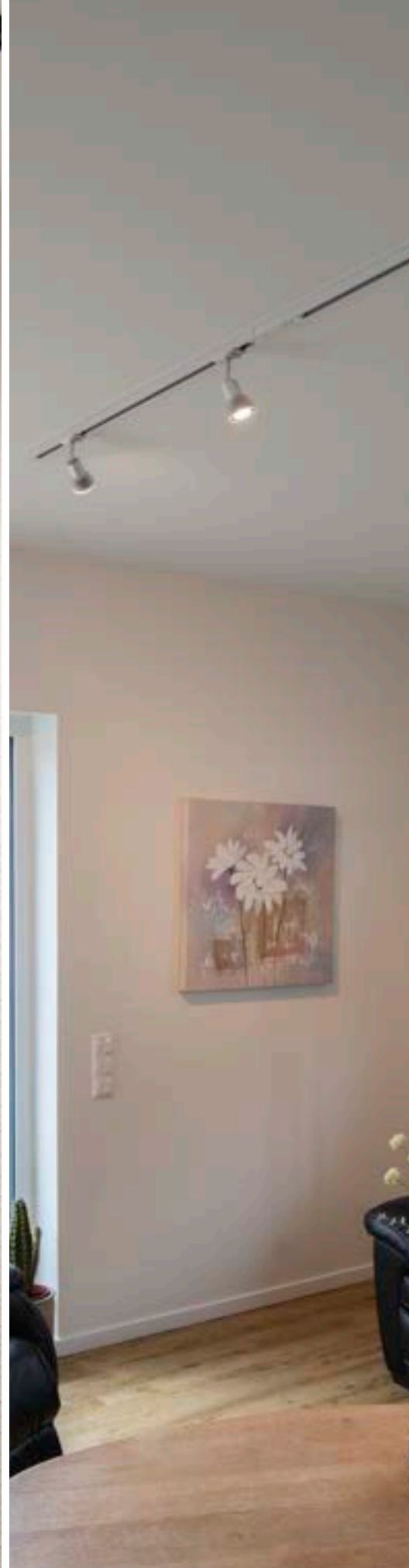

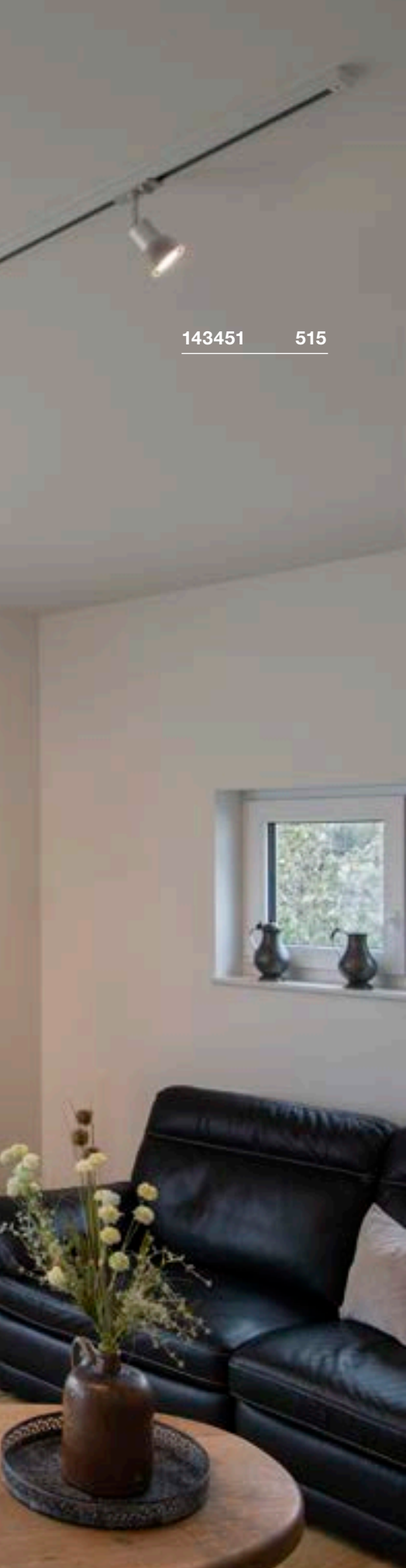

143451 515

### PURIA TRACK Monof., QPAR51

### AVO TRACK Monof., QPAR51

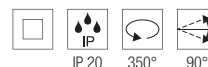
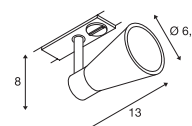
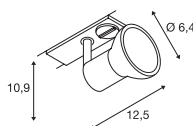

220-240V ~50/60Hz  
Material: alumínio/plástico

220-240V ~50/60Hz  
Material: aço



Casquilho: 1xGU10

Casquilho: 1xGU10

Máx. Ø: 5,1 cm

Variante	Art. n.º	EUR
● Preto	143450	42,75
○ Branco	143451	42,75
● Cinzento	143454	42,75

Variante	Art. n.º	EUR
● Preto	144200	38,50
○ Branco	144201	38,50
● Cinzento	144204	38,50



LED GU10 51mm | 6W | 36°  
2200-2700K | 360lm | EE=G  
6kWh/1000h



Art. N.º: 1005273 | 9,99 EUR



LED GU10 51mm | 6W | 38°  
2700K | 450lm | EE=F  
6kWh/1000h



Art. N.º: 1005077 | 7,50 EUR

# ENOLA C TRACK

Monof.

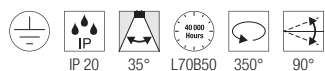
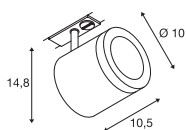

220-240V ~50/60Hz | 500mA  
 Potência total: 11W  
 Material: alumínio/vidro



Down 1040lm | 3000K

Variante	Art. n.º	EUR
● Preto	1000711	177,00
○ Branco	143941	177,00





### ENOLA C TRACK monof.

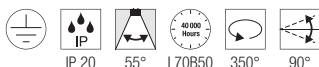
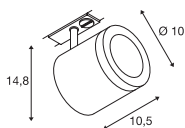

220-240V ~50/60Hz | 500mA  
Potência total: 11W  
Material: alumínio/vidro



Down 1040lm | 3000K

Variante	Art. n.º	EUR
● Preto	1000712	177,00
○ Branco	143951	177,00

### ENOLA B TRACK Monof., QPAR51

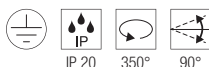
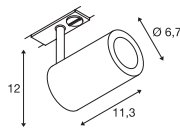

220-240V ~50/60Hz  
Material: alumínio/aço



Casquilho: 1xGU10 Máx. Ø: 5,1 cm C: 6,7 cm

Variante	Art. n.º	EUR
● Preto	1002110	70,00
○ Branco	1002111	70,00
● Cinzento	1002113	70,00



LED GU10 51mm | 6W | 38°  
2700K | 450lm | EE=F  
6kWh/1000h



Art. N.º: 1005075 | 7,50 EUR

### ENOLA B PD, QPAR51

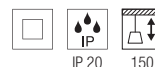

220-240V ~50/60Hz  
Material: alumínio/aço



Casquilho: 1xGU10

Variante	Art. n.º	EUR
● Preto	143960	125,00
○ Branco	143961	125,00



LED GU10 51mm | 6W | 38°  
2700K | 450lm | EE=F  
6kWh/1000h



Art. N.º: 1005077 | 7,50 EUR

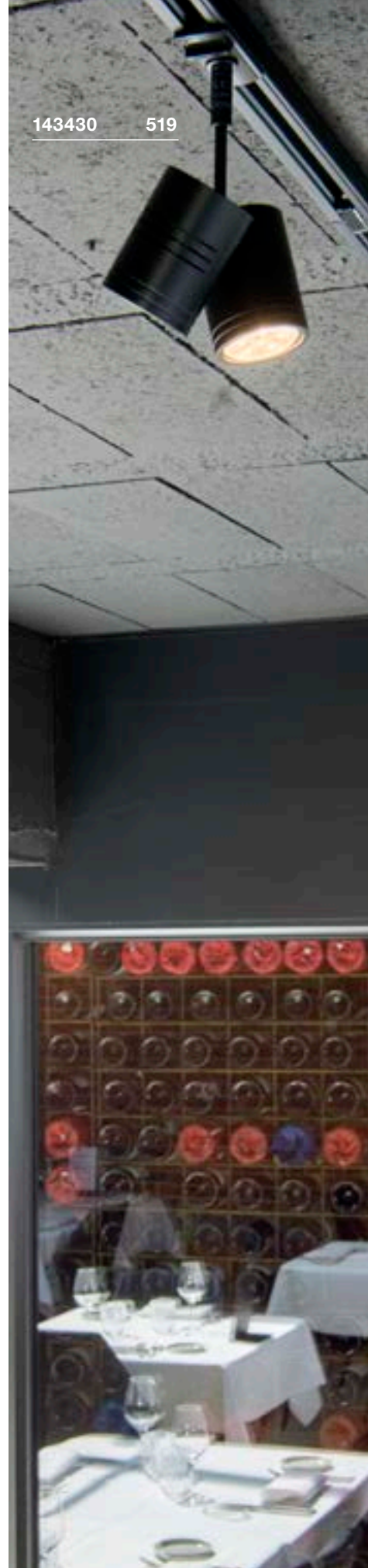



**BIMA**  
Monof., single, QPAR51

**BIMA**  
Monof., double, QPAR51

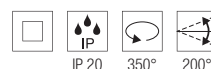
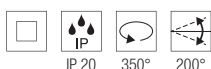
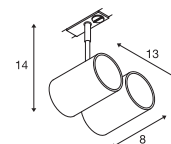
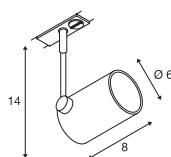

220-240V ~50/60Hz  
Material: alumínio

220-240V ~50/60Hz  
Material: alumínio



Casquilho: 1xGU10 Máx. Ø: 5,1 cm | C: 5,7 cm

Casquilho: 2xGU10 Máx. Ø: 5,1 cm | C: 5,7 cm

Variante	Art. n.º	EUR
● Preto	143440	45,00
○ Branco	143441	45,00
● Cinzento	143442	45,00

Variante	Art. n.º	EUR
● Preto	143430	70,00
○ Branco	143431	70,00
● Cinzento	143432	70,00



LED GU10 51mm | 6W | 38°  
2700K | 450lm | EE=F  
6kWh/1000h



Art. N.º: 1005075 | 7,50 EUR



LED GU10 51mm | 6W | 38°  
2700K | 450lm | EE=F  
6kWh/1000h



Art. N.º: 1005077 | 7,50 EUR



KALU TRACK  
Monof., PHASE

KALU TRACK  
Monof., QPAR111

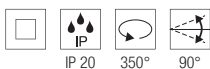
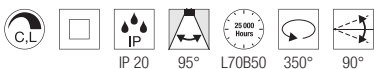
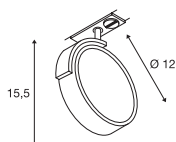
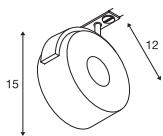

220-240V ~50/60Hz  
Potência total: 13W  
Material: alumínio

220-240V ~50/60Hz  
Material: alumínio/plástico



Down 970lm | 3000K



Casquilho: 1xGU10

Variante	Art. n.º	EUR
● Preto	1002854	206,00
○ Branco	143731	206,00

Variante	Art. n.º	EUR
● Preto	143540	75,00
○ Branco	143541	75,00
● Cinzento	143544	75,00



QPAR111 | 12,5W | 10°  
3000K | 950lm | EE=F  
13kWh/1000h



Art. N.º: 1005278 | 55,00 EUR

1002854 520

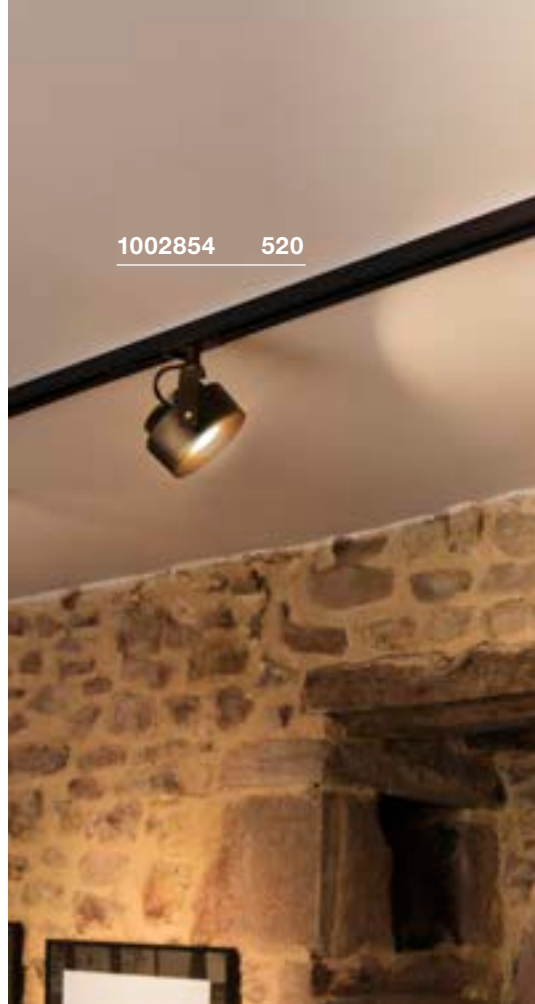

1001861 521







**EURO SPOT TRACK**  
Monof., QPAR51

**ALTRA DICE TRACK**  
Monof., QPAR51

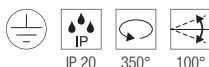
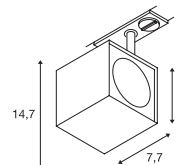
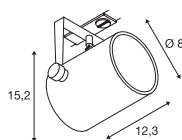

220-240V ~50/60Hz  
Material: alumínio

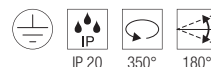

220-240V ~50/60Hz  
Material: alumínio

143350 521



Casquilho: 1xGU10

Variante	Art. n.º	EUR
● Preto	1001861	77,00
○ Branco	143811	77,00



Casquilho: 1xGU10

Variante	Art. n.º	EUR
● Preto	143350	85,00
○ Branco	143351	85,00
● Cinzento	143354	85,00



LED GU10 51mm | 6W | 38°  
2700K | 450lm | EE=F  
6kWh/1000h



Art. N.º: 1005077 | 7,50 EUR



LED GU10 51mm | 6W | 36°  
2200-2700K | 360lm | EE=G  
6kWh/1000h



Art. N.º: 1005273 | 9,99 EUR



# PERSONALIZE A SUA CALHA ELETRIFICADAS 230V AC

---

Construção profissional: uma iluminação bem pensada é essencial, especialmente onde há muito para ver. Por serem luminárias que podem ser utilizadas de forma flexível na calha eletrificada, permitem iluminar perfeitamente os objetos desejados. O conceito de iluminação pode ser alterado em qualquer momento. As calhas eletrificadas de três circuitos 230V AC (trifásicas) são ideais para lojas e stands de exposição. Em conjunto com as luminárias SLV adequadas, permitem criar o ambiente perfeito e colocam produtos e peças de exposição na luz certa. As calhas eletrificadas de um circuito 230V AC (monofásicas) são particularmente adequadas para casas particulares e enchem as divisões com uma luz acolhedora. As calhas eletrificadas de alumínio podem ser fácil e rapidamente fixadas no teto, graças às aberturas disponíveis no perfil. Pode escolher entre uma versão encastrada e uma versão saliente, disponíveis em várias cores.

## SELECIONE A(S) SUA(S) ...

- 1 calha(s) eletrificada(s)  
(S-TRACK, EUTRAC, sistema monofásico)
- 2 Tipo de montagem  
(calha eletrificada para encastrar/saliente)
- 3 Luminária
- 4 Opções de configuração



JÁ ESTÁ!

# SISTEMAS DE CALHAS ELETRIFICADAS

**S-TRACK**  
Sistema trifásico



**EUTRAC**  
Sistema trifásico



**SISTEMA MONOFÁSICO**



Calha eletrificada  
encastrada



Calha eletrificada  
saliente



Teto



Parede



Suspensa

Opções de colocação

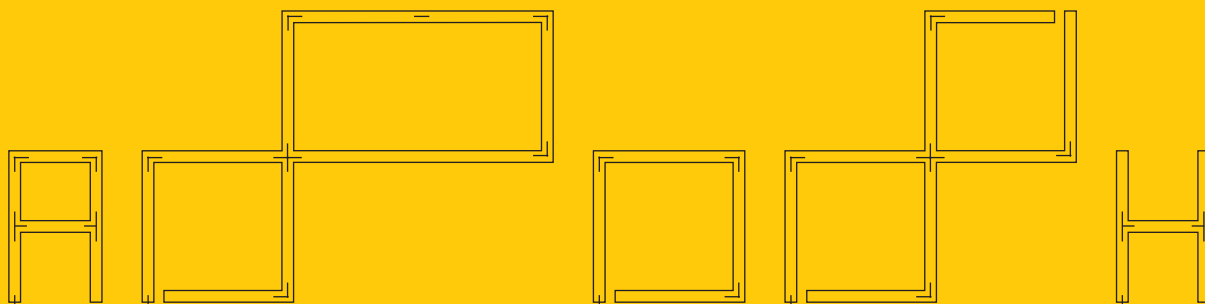

Diferentes opções de configuração, individualmente adaptadas ao seu espaço

Utilize também o nosso configurador Track [slv.com](https://www.slv.com)



1006159 552



Encontre a família NUMINOS® nas páginas 110–115

LED



Encontre a família ONE® nas páginas 194–195

LED



TS V | 543



TS V | 543



NOBLO® SPOT | 545



NOBLO® SPOT | 545



NOBLO® SPOT | 547



NOBLO® SPOT | 547



PANTILO ROPE 19 | 549



SIGHT TRACK | 550



SIGHT TRACK | 550



SIGHT MOVE | 551



SIGHT MOVE | 551



PARA CONE GL | 552



PARA CONE GL | 552



PARA CONE 14 | 553



PARA CONE 14 | 553



FORCHINI M 40 TRACK | 554



EURO CUBE | 555



EURO SPOT TRACK | 555



EURO SPOT TRACK | 555



ALTRA DICE TRACK | 556



PURI TRACK | 557



PURI TRACK GLASS | 557



KALU TRACK LED | 558



KALU TRACK | 558



BIMA | 559



BIMA | 559



HELIA 50 TRACK | 561







ENOLA C TRACK | 561





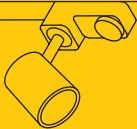

AVO TRACK | 561

# COMPATIBILIDADE DAS CALHAS TRIFÁSICAS

Compatível com luminárias/adaptadores de:



	SLV	Global/Nordic	EUTRAC®
calhas eletrificadas SLV e componentes de calhas eletrificadas S-Track DALI 			
sem DALI	✓	✓	★
com DALI	✓	✓	✗

Compatível com calhas eletrificadas e componentes de calhas eletrificadas de:

	SLV S-TRACK	Global/Nordic	EUTRAC®
Luminárias SLV S-Track DALI 			
sem DALI	✓	✓	✓
com DALI	✓	✓	✓★★★

★ Sujeito a testes anteriores com amostras da luminária e da calha eletrificada  
★★★ No entanto, sem a funcionalidade DALI

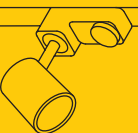
Os sistemas e componentes das calhas eletrificadas SLV são altamente compatíveis com luminárias e adaptadores de: EUTRAC®, Zumtobel, Erco, LTS ONETrack e Unipro®. Sujeito a testes anteriores com amostras das luminárias e calhas eletrificadas.

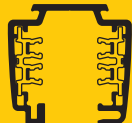
Zumtobel	Erco	LTS ONETrack	unipro®
			
✓	✓	✓	✓
✗	✗	✓	✓
Zumtobel	Erco	LTS ONETrack	unipro®
			
✓	✓	✓	✓
✗	✗	✓	✓

Informações fornecidas sem garantia.

Os dados técnicos e as dimensões estão sujeitos a alterações a qualquer momento e sem aviso prévio.

Verificar com uma amostra durante a fase de planeamento do projeto, para garantir a funcionalidade.

Compatibilidade refere-se apenas a calhas eletrificadas/luminárias.

Calhas eletrificadas e componentes de calhas eletrificadas de diferentes fabricantes não devem ser combinados.







# S-TRACK

Calha eletrificada saliente trifásica + DALI

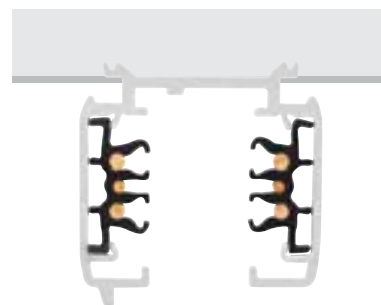

	1 m	1 m	2 m	2 m
Tensão nominal (V)	220-240V ~50/60Hz	220-240V ~50/60Hz	220-250V ~50/60Hz	220-250V ~50/60Hz
Intensidade máx. de corrente (A)	16	16	16	16
Carga mec. máx.	30 kg	30 kg	30 kg	30 kg
Cor	● Preto	○ Branco	● Preto	○ Branco
Material	Alumínio	Alumínio	Alumínio	Alumínio
C x L x A (cm)	100 x 3,6 x 3,6	100 x 3,6 x 3,6	200 x 3,6 x 3,6	200 x 3,6 x 3,6
Art. n.º	1004937	1004938	1002631	1002632
EUR	45,50	45,50	81,00	81,00
	3 m	3 m	4 m	4 m
Tensão nominal (V)	220-250V ~50/60Hz	220-250V ~50/60Hz	220-250V ~50/60Hz	220-250V ~50/60Hz
Intensidade máx. de corrente (A)	16	16	16	16
Carga mec. máx.	30 kg	30 kg	30 kg	30 kg
Cor	● Preto	○ Branco	● Preto	○ Branco
Material	Alumínio	Alumínio	Alumínio	Alumínio
C x L x A (cm)	300 x 3,6 x 3,6	300 x 3,6 x 3,6	400 x 3,6 x 3,6	400 x 3,6 x 3,6
Art. n.º	1002633	1002634	1002635	1002636
EUR	117,00	117,00	147,00	147,00

# S-TRACK

Calha eletrificada saliente trifásica DALI  
 Guia de planeamento e visão geral de acessórios

Vista de cima dos componentes  
 no lado da montagem

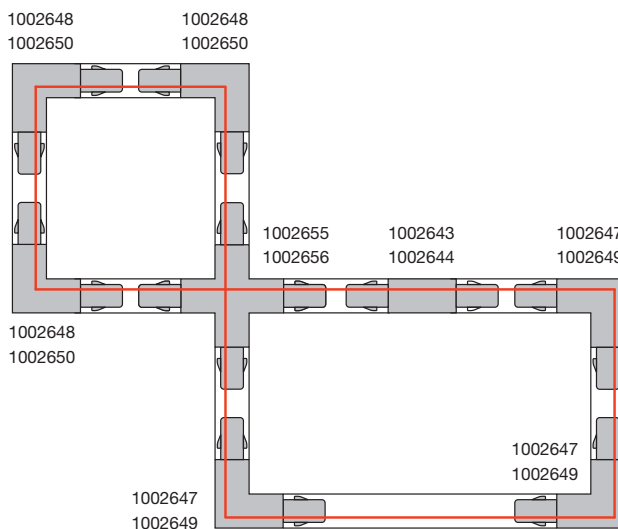
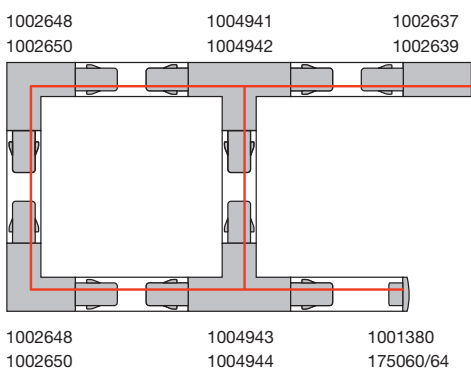
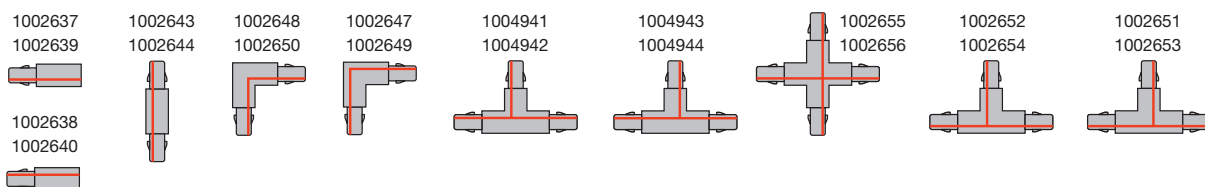
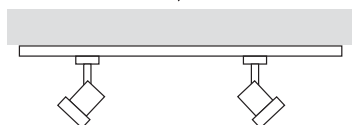

**Alimentador, DALI, terra esquerda**  
 16A máx. | Policarbonato (PC) / Policarbonato (PC)  
 C: 13,9 cm | L: 3,5 cm | A: 3,3 cm

- Preto Art. n.º **1002637** **19,00 EUR**
- Branco **1002639** **19,00 EUR**



**Conector em L, DALI, terra exterior\***  
 16A máx. | Policarbonato (PC)  
 C: 11,9 cm | L: 11,9 cm | A: 3,3 cm

- Preto Art. n.º **1002647** **33,25 EUR**
- Branco **1002649** **33,25 EUR**



**Alimentador, Dali, terra direita**  
 16A máx. | Policarbonato (PC)  
 C: 13,9 cm | L: 3,5 cm | A: 3,3 cm

- Preto Art. n.º **1002638** **19,00 EUR**
- Branco **1002640** **19,00 EUR**



**Conector em L, DALI, terra interior\***  
 16A máx. | Policarbonato (PC)  
 C: 11,9 cm | L: 11,9 cm | A: 3,3 cm

- Preto Art. n.º **1002648** **33,25 EUR**
- Branco **1002650** **33,25 EUR**



**Conector em T, DALI, terra exterior, esquerda\***  
16A máx. | Policarbonato (PC)  
C: 20,3 cm | L: 11,9 cm | A: 3,3 cm

● Preto Art. n.º 1002652 39,00 EUR  
○ Branco 1002654 39,00 EUR

**trif. Adaptador, Dali**  
10 A máx. | Policarbonato (PC)  
C: 11,3 cm | L: 5,5 cm | A: 3,3 cm

● Preto Art. n.º 1002660 18,70 EUR  
○ Branco 1002659 18,70 EUR

**Conector em T, DALI, terra exterior, direita\***  
16A máx. | Policarbonato (PC)  
C: 20,3 cm | L: 11,9 cm | A: 3,3 cm

● Preto Art. n.º 1002651 39,00 EUR  
○ Branco 1002653 39,00 EUR

**Adaptador trif. mec.**  
Alumínio/plástico  
C: 6,6 cm | L: 6,6 cm | A: 3,1 cm

● Preto Art. n.º 175210 15,40 EUR  
○ Branco 1001395 15,40 EUR

**Conector em T, DALI, terra interior, esquerda\***  
16A máx. | Policarbonato (PC)  
C: 20,3 cm | L: 11,9 cm | A: 3,3 cm

● Preto Art. n.º 1004941 39,00 EUR  
○ Branco 1004942 39,00 EUR

**Cobertura, 2 m**  
Policarbonato (PC)  
C: 200 cm | L: 2,2 cm | A: 0,75 cm

● Preto Art. n.º 1004939 7,55 EUR  
○ Branco 1004940 7,55 EUR

**Conector em T, DALI, terra interior, direita\***  
16A máx. | Policarbonato (PC)  
C: 20,3 cm | L: 11,9 cm | A: 3,3 cm

● Preto Art. n.º 1004943 39,00 EUR  
○ Branco 1004944 39,00 EUR

**Tampa**  
Plástico  
C: 3,5 cm | L: 3,3 cm | A: 3,2 cm

● Preto Art. n.º 175060 2,00 EUR  
○ Branco 1001380 2,00 EUR

**Conector em X, DALI\***  
16A máx. | Policarbonato (PC) / Policarbonato (PC)  
C: 20,3 cm | L: 20,3 cm | A: 3,3 cm

● Preto Art. n.º 1002655 63,00 EUR  
○ Branco 1002656 63,00 EUR

**Estrutura suspensa**  
Alumínio/plástico  
C: 6 cm | L: 6 cm | A: 4 cm  
Carga mecânica máx.: 10 kg

● Preto Art. n.º 175160 32,50 EUR  
○ Branco 1001390 32,50 EUR

**Conectores longitudinais, DALI\***  
16A máx. | Policarbonato (PC)  
C: 20,3 cm | L: 3,5 cm | A: 3,3 cm

● Preto Art. n.º 1002643 33,25 EUR  
○ Branco 1002644 33,25 EUR

**Conector de calha eletrificada**  
Alumínio  
C: 18,2 cm | L: 3,3 cm | A: 2,1 cm

● Preto Art. n.º 175180 11,90 EUR  
○ Branco 1001392 11,90 EUR

**Miniconector, DALI**  
16A máx. | Policarbonato (PC)  
C: 10,6 cm | L: 2,5 cm | A: 2,8 cm

● Preto Art. n.º 1002641 10,10 EUR  
○ Branco 1002642 10,10 EUR

**Adaptador trif. Adaptador com gancho**  
Plástico/aço  
A: 5,2 cm  
Carga mecânica máx.: 10 kg

● Preto Art. n.º 175190 2,70 EUR  
○ Branco 1001393 2,70 EUR

**Conector flexível, DALI**  
16A máx. | Policarbonato (PC)  
C: 28,5 cm | L: 3,5 cm | A: 3,3 cm

● Preto Art. n.º 1002645 54,00 EUR  
○ Branco 1002646 54,00 EUR

**Roseta para teto, DALI**  
16A máx. | Policarbonato (PC)  
A: 3,5 cm Ø: 14,3 cm

● Preto Art. n.º 1004684 37,75 EUR  
○ Branco 1004685 37,75 EUR

**Conector isolante**  
Plástico  
C: 6,8 cm | L: 3,1 cm | A: 2,6 cm

● Preto Art. n.º 175080 7,65 EUR  
○ Branco 1001382 7,65 EUR

**Suspensão de cabos de aço (2 un.)**  
Aço inoxidável/bronze  
C: 500 cm  
Carga mecânica máx.: 10 kg

● Níquel Art. n.º 1002845 41,75 EUR

**Acessório de suspensão, DALI**  
Aço  
C: 4 cm | L: 3,4 cm | A: 1,25 cm

● Preto Art. n.º 1002657 7,65 EUR  
○ Branco 1002658 7,65 EUR

\* Com opção de alimentação





# S-TRACK

Calha eletrificada de montagem encastrada trifásica, DALI

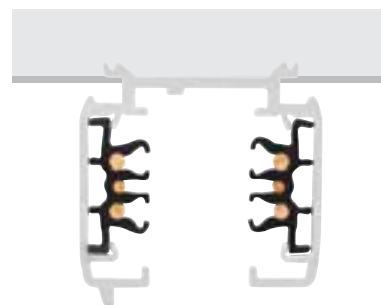

	1 m	1 m	2 m	2 m
Tensão nominal (V)	220-250V ~50/60Hz	220-250V ~50/60Hz	220-250V ~50/60Hz	220-250V ~50/60Hz
Intensidade máx. de corrente (A)	16	16	16	16
Carga mec. máx.	30 kg	30 kg	30 kg	30 kg
Cor	● Preto	○ Branco	● Preto	○ Branco
Material	Alumínio	Alumínio	Alumínio	Alumínio
C x L x A (cm)	100 x 5,6 x 3,2	100 x 5,6 x 3,2	200 x 5,6 x 3,2	200 x 5,6 x 3,2
Art. n.º	1006511 ●	1006512 ●	1006513 ●	1006514 ●
EUR	53,00	53,00	96,00	96,00
	3 m	3 m	4 m	4 m
Tensão nominal (V)	220-250V ~50/60Hz	220-250V ~50/60Hz	220-250V ~50/60Hz	220-250V ~50/60Hz
Intensidade máx. de corrente (A)	16	16	16	16
Carga mec. máx.	30 kg	30 kg	30 kg	30 kg
Cor	● Preto	○ Branco	● Preto	○ Branco
Material	Alumínio	Alumínio	Alumínio	Alumínio
C x L x A (cm)	300 x 5,6 x 3,2	300 x 5,6 x 3,2	400 x 5,6 x 3,2	400 x 5,6 x 3,2
Art. n.º	1006515 ●	1006516 ●	1006517 ●	1006518 ●
EUR	137,00	137,00	217,00	217,00



# S-TRACK

Calha eletrificada de montagem encastrada trifásica, DALI  
Guia de planeamento e visão geral de acessórios

Vista de cima dos componentes  
no lado da montagem

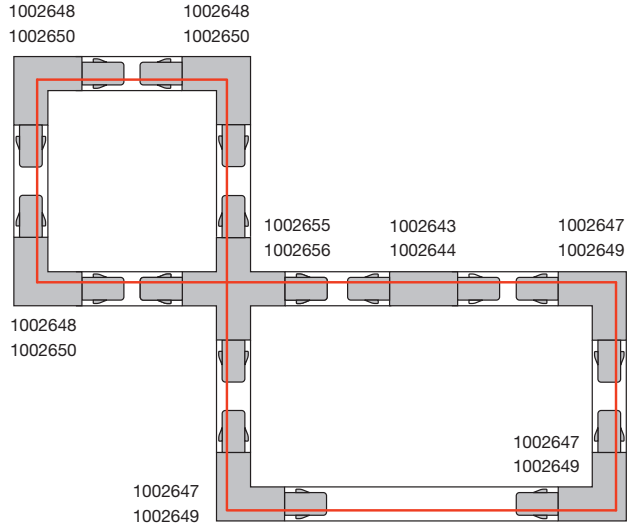
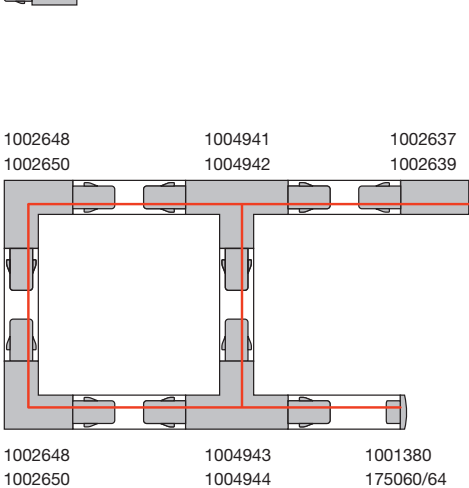
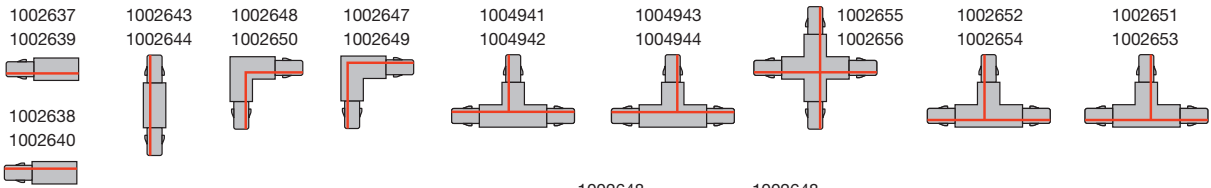
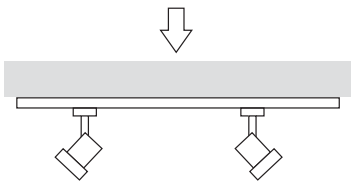



**Alimentador, DALI, terra direita**  
16A máx. | Policarbonato (PC)  
C: 14,7 cm | L: 5,6 cm | A: 3,3 cm

- Preto Art. n.º 1006519 33,25 EUR
- Branco 1006520 33,25 EUR



**Conector em T, DALI, terra exterior, direita\***  
16A máx. | Policarbonato (PC)  
C: 20,3 cm | L: 13 cm | A: 3,3 cm

- Preto Art. n.º 1006533 39,00 EUR
- Branco 1006534 39,00 EUR



**Alimentador, DALI, terra esquerda**  
16A máx. | Policarbonato (PC)  
C: 14,7 cm | L: 5,6 cm | A: 3,3 cm

- Preto Art. n.º 1006521 33,25 EUR
- Branco 1006522 33,25 EUR



**Conector em T, DALI, terra interior, esquerda\***  
16A máx. | Policarbonato (PC)  
C: 20,3 cm | L: 13 cm | A: 3,3 cm

- Preto Art. n.º 1006527 39,00 EUR
- Branco 1006528 39,00 EUR



**Conector em L, DALI, terra exterior\***  
16A máx. | Policarbonato (PC)  
C: 13 cm | L: 13 cm | A: 3,3 cm

- Preto Art. n.º 1006525 33,25 EUR
- Branco 1006526 33,25 EUR



**Conector em X, DALI\***  
16A máx. | Policarbonato (PC)  
C: 20,3 cm | L: 20,3 cm | A: 3,3 cm

- Preto Art. n.º 1006535 63,00 EUR
- Branco 1006536 63,00 EUR



**Conector em L, DALI, terra interior\***  
16A máx. | Policarbonato (PC)  
C: 13 cm | L: 13 cm | A: 3,3 cm

- Preto Art. n.º 1006523 33,25 EUR
- Branco 1006524 33,25 EUR



**Conectores longitudinais, DALI\***  
16A máx. | Policarbonato (PC)  
C: 20,3 cm | L: 5,6 cm | A: 3,3 cm

- Preto Art. n.º 1006537 33,25 EUR
- Branco 1006538 33,25 EUR



**Conector em T, DALI, terra exterior, esquerda\***  
16A máx. | Policarbonato (PC)  
C: 20,3 cm | L: 13 cm | A: 3,3 cm

- Preto Art. n.º 1006529 39,00 EUR
- Branco 1006530 39,00 EUR



**Miniconector, DALI**  
16A máx. | Policarbonato (PC)  
C: 10,6 cm | L: 2,5 cm | A: 2,8 cm

- Preto Art. n.º 1002641 10,10 EUR
- Branco 1002642 10,10 EUR



**Conector em T, DALI, terra interior, direita\***  
16A máx. | Policarbonato (PC)  
C: 20,3 cm | L: 13 cm | A: 3,3 cm

- Preto Art. n.º 1006531 39,00 EUR
- Branco 1006532 39,00 EUR



**Tampa, DALI**  
Policarbonato (PC)  
C: 4,79 cm | L: 5,6 cm

- Preto Art. n.º 1006539 2,00 EUR
- Branco 1006540 2,00 EUR

\* Com opção de alimentação







# EUTRAC®

Calha eletrificada saliente trifásica

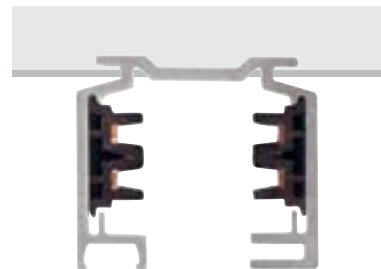

	<b>1 m</b>	<b>1 m</b>	<b>1 m</b>
Tensão nominal (V)	220-240V ~50/60Hz	220-240V ~50/60Hz	220-240V ~50/60Hz
Intensidade máx. de corrente (A)	16	16	16
Cor	● Preto	○ Branco	● Cinzento
Material	Alumínio/plástico	Alumínio/plástico	Alumínio/plástico
C x L x A (cm)	100 x 3,6 x 3,2	100 x 3,6 x 3,2	100 x 3,6 x 3,2
Art. n.º	<b>145100</b>	<b>1001510</b>	<b>145102</b>
EUR	<b>49,50</b>	<b>49,50</b>	<b>49,50</b>
	<b>2 m</b>	<b>2 m</b>	<b>2 m</b>
Tensão nominal (V)	220-240V ~50/60Hz	220-240V ~50/60Hz	220-240V ~50/60Hz
Intensidade máx. de corrente (A)	16	16	16
Cor	● Preto	○ Branco	● Cinzento
Material	Alumínio/plástico	Alumínio/plástico	Alumínio/plástico
C x L x A (cm)	200 x 3,6 x 3,2	200 x 3,6 x 3,2	200 x 3,6 x 3,2
Art. n.º	<b>145200</b>	<b>1001511</b>	<b>145202</b>
EUR	<b>90,00</b>	<b>90,00</b>	<b>90,00</b>
	<b>3 m</b>	<b>3 m</b>	<b>3 m</b>
Tensão nominal (V)	220-240V ~50/60Hz	220-240V ~50/60Hz	220-240V ~50/60Hz
Intensidade máx. de corrente (A)	16	16	16
Cor	● Preto	○ Branco	● Cinzento
Material	Alumínio/plástico	Alumínio/plástico	Alumínio/plástico
C x L x A (cm)	300 x 3,6 x 3,2	300 x 3,6 x 3,2	300 x 3,6 x 3,2
Art. n.º	<b>145300</b>	<b>1001512</b>	<b>145302</b>
EUR	<b>141,00</b>	<b>141,00</b>	<b>141,00</b>

# EUTRAC®

## Calha eletrificada saliente trifásica Guia de planeamento e visão geral de acessórios

Vista de cima dos componentes  
no lado da montagem

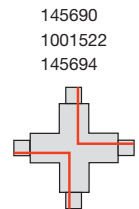
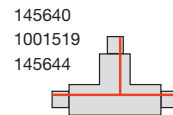
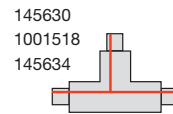
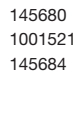
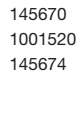
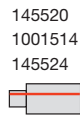
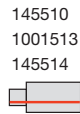
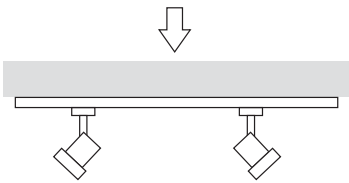

Exemplo: terra exterior

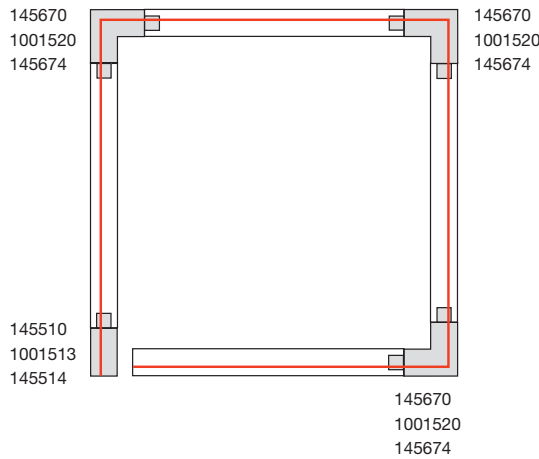

Exemplo: terra interior

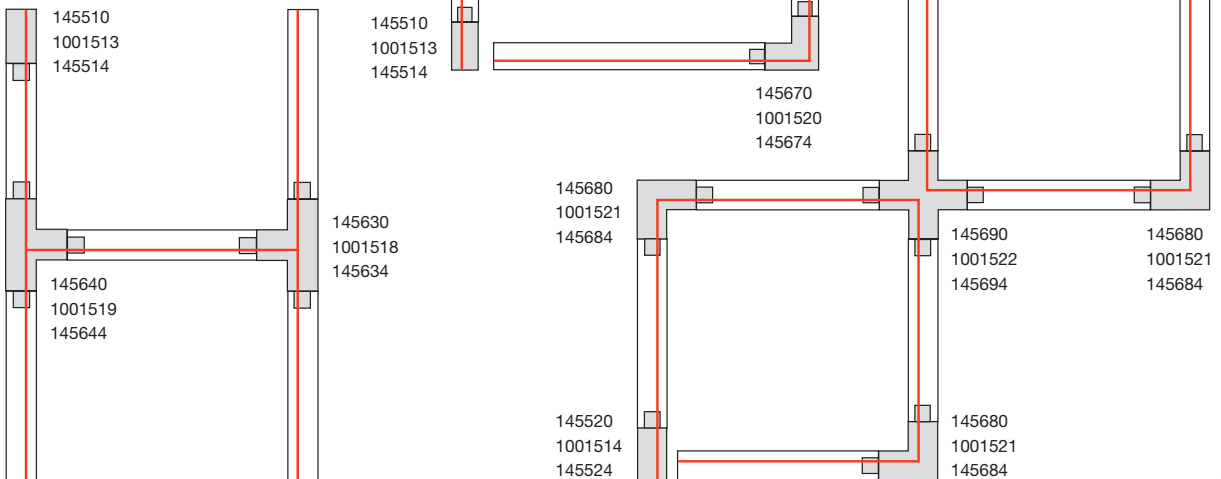



 <p><b>Alimentador, terra esquerda</b> 16A máx.   Plástico C: 11,2 cm   L: 3,6 cm   A: 3,2 cm</p> <ul style="list-style-type: none"> <li>● Preto Art. n.º 145510 19,70 EUR</li> <li>○ Branco 1001513 19,70 EUR</li> <li>● Cinzento 145514 19,70 EUR</li> </ul>	 <p><b>Conector de calha eletrificada</b> Plástico C: 10 cm   L: 3,6 cm   A: 1,9 cm</p> <ul style="list-style-type: none"> <li>● Preto Art. n.º 145600 21,75 EUR</li> <li>○ Branco 1001523 21,75 EUR</li> <li>● Cinzento 145604 21,75 EUR</li> </ul>
 <p><b>Alimentador, terra direita</b> 16A máx.   Plástico C: 11,2 cm   L: 3,6 cm   A: 3,2 cm</p> <ul style="list-style-type: none"> <li>● Preto Art. n.º 145520 19,70 EUR</li> <li>○ Branco 1001514 19,70 EUR</li> <li>● Cinzento 145524 19,70 EUR</li> </ul>	 <p><b>Conector flex.</b> 16A máx.   Plástico C: 30,7 cm   L: 3,6 cm   A: 3,2 cm</p> <ul style="list-style-type: none"> <li>● Preto Art. n.º 145580 89,00 EUR</li> <li>○ Branco 1001524 89,00 EUR</li> <li>● Cinzento 145584 89,00 EUR</li> </ul>
 <p><b>Alimentador intermédio</b> 16A máx.   Plástico C: 13 cm   L: 3,6 cm   A: 3,6 cm</p> <ul style="list-style-type: none"> <li>● Preto Art. n.º 145530 44,75 EUR</li> <li>○ Branco 1001515 44,75 EUR</li> <li>● Cinzento 145534 44,75 EUR</li> </ul>	 <p><b>Tomada</b> 6,3 A máx.   Plástico C: 9,6 cm   L: 6,5 cm   A: 9 cm</p> <ul style="list-style-type: none"> <li>● Preto Art. n.º 145700 94,00 EUR</li> <li>○ Branco 1001525 94,00 EUR</li> </ul>
 <p><b>Conector longitudinal*</b> 16A máx.   Plástico C: 19,2 cm   L: 3,6 cm   A: 3,2 cm</p> <ul style="list-style-type: none"> <li>● Preto Art. n.º 145660 78,00 EUR</li> <li>○ Branco 1001517 78,00 EUR</li> <li>● Cinzento 145664 78,00 EUR</li> </ul>	 <p><b>Trifásico</b> 10 A máx.   Plástico C: 9,6 cm   L: 3,5 cm   A: 4,5 cm Carga mecânica máx.: 5 kg</p> <ul style="list-style-type: none"> <li>● Preto Art. n.º 145990 19,70 EUR</li> <li>○ Branco 1001542 19,70 EUR</li> <li>● Cinzento 145994 19,70 EUR</li> </ul>
 <p><b>Conector longitudinal*</b> 16A máx.   Plástico C: 5,8 cm   L: 1,5 cm   A: 2,6 cm</p> <ul style="list-style-type: none"> <li>● Preto Art. n.º 145560 19,70 EUR</li> <li>○ Branco 1001516 19,70 EUR</li> <li>● Cinzento 145564 19,70 EUR</li> </ul>	 <p><b>Acessório de suspensão</b> Alumínio C: 5 cm   L: 3,6 cm   A: 1,9 cm</p> <ul style="list-style-type: none"> <li>● Preto Art. n.º 145730 11,40 EUR</li> <li>○ Branco 1001530 11,40 EUR</li> <li>● Cinzento 145734 11,40 EUR</li> </ul>
 <p><b>Conector em L, terra interior*</b> 16A máx.   Plástico C: 15 cm   L: 15 cm   A: 3,2 cm</p> <ul style="list-style-type: none"> <li>● Preto Art. n.º 145680 65,00 EUR</li> <li>○ Branco 1001521 65,00 EUR</li> <li>● Cinzento 145684 65,00 EUR</li> </ul>	 <p><b>Ponto de saída universal</b> 16A máx.   Plástico A: 3,1 cm Ø: 11,9 cm</p> <ul style="list-style-type: none"> <li>● Preto Art. n.º 145830 104,00 EUR</li> <li>○ Branco 1001526 104,00 EUR</li> <li>● Cinzento 145834 104,00 EUR</li> </ul>
 <p><b>Conector em L, terra exterior*</b> 16A máx.   Plástico C: 15 cm   L: 15 cm   A: 3,2 cm</p> <ul style="list-style-type: none"> <li>● Preto Art. n.º 145670 65,00 EUR</li> <li>○ Branco 1001520 65,00 EUR</li> <li>● Cinzento 145674 65,00 EUR</li> </ul>	 <p><b>Tampa</b> Plástico C: 3,6 cm   L: 1,7 cm   A: 3,2 cm</p> <ul style="list-style-type: none"> <li>● Preto Art. n.º 145590 4,00 EUR</li> <li>○ Branco 1001527 4,00 EUR</li> <li>● Cinzento 145594 4,00 EUR</li> </ul>
 <p><b>Conector em T, terra interior, esquerda*</b> 16A máx.   Plástico C: 26 cm   L: 18,5 cm   A: 3,2 cm</p> <ul style="list-style-type: none"> <li>● Preto Art. n.º 145630 89,00 EUR</li> <li>○ Branco 1001518 89,00 EUR</li> <li>● Cinzento 145634 89,00 EUR</li> </ul>	 <p><b>Estrutura suspensa, fixa</b> Plástico/aço C: 60 cm   A: 63,5 cm Ø: 7 cm</p> <ul style="list-style-type: none"> <li>● Preto Art. n.º 145720 39,00 EUR</li> <li>○ Branco 1001529 39,00 EUR</li> <li>● Cinzento 145724 39,00 EUR</li> </ul>
 <p><b>Conector em T, terra interior, direita*</b> 16A máx.   Plástico C: 26 cm   L: 18,5 cm   A: 3,2 cm</p> <ul style="list-style-type: none"> <li>● Preto Art. n.º 145640 89,00 EUR</li> <li>○ Branco 1001519 89,00 EUR</li> <li>● Cinzento 145644 89,00 EUR</li> </ul>	 <p><b>Estrutura suspensa, fixa</b> Plástico/aço A: 122 cm Ø: 7 cm</p> <ul style="list-style-type: none"> <li>● Preto Art. n.º 145710 44,75 EUR</li> <li>○ Branco 1001528 44,75 EUR</li> <li>● Cinzento 145714 44,75 EUR</li> </ul>
 <p><b>Conector em X*</b> 16A máx.   Plástico C: 26 cm   L: 26 cm   A: 3,2 cm</p> <ul style="list-style-type: none"> <li>● Preto Art. n.º 145690 130,00 EUR</li> <li>○ Branco 1001522 130,00 EUR</li> <li>● Cinzento 145694 130,00 EUR</li> </ul>	 <p><b>Suspensão de cabos de aço (2 un.)</b> Aço inoxidável/bronze C: 500 cm Carga mecânica máx.: 10 kg</p> <ul style="list-style-type: none"> <li>● Níquel Art. n.º 1002845 41,75 EUR</li> </ul>

\* Com opção de alimentação





# EUTRAC®

Calha eletrificada de montagem encastrada trifásica com acessórios adequados

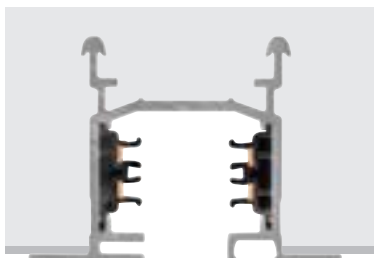

	2 m	3 m
Tensão nominal (V)	220-240V ~50/60Hz	220-240V ~50/60Hz
Intensidade máx. de corrente (A)	16	16
Cor	<input type="radio"/> Branco	<input type="radio"/> Branco
Material	Alumínio/plástico	Alumínio/plástico
C x L x A (cm)	200 x 5,9 x 4,1	300 x 5,9 x 4,1
Art. n.º	<b>1001531</b>	<b>1001532</b>
EUR	<b>121,00</b>	<b>201,00</b>



**Alimentador, terra esquerda**  
16A máx. | Plástico/Aço  
C: 12,2 cm | L: 6 cm | A: 3,4 cm

Branco Art. n.º **1001533** **32,50 EUR**



**Tampa**  
Plástico  
C: 2,7 cm | L: 6 cm | A: 3,2 cm

Branco Art. n.º **1001538** **7,65 EUR**



**Alimentador, terra direita**  
16A máx. | Plástico/Aço  
C: 12,2 cm | L: 6 cm | A: 3,4 cm

Branco Art. n.º **1001534** **32,50 EUR**



**Conector longitudinal com estabilizador**  
16A máx. | Plástico/Aço  
C: 6,2 cm | L: 2,5 cm | A: 2,7 cm

Branco Art. n.º **1001539** **27,25 EUR**



**Conector em L, terra exterior, com opção de alimentação**  
16A máx. | Plástico/Aço  
C: 16 cm | L: 16 cm | A: 3,2 cm

Branco Art. n.º **1001536** **78,00 EUR**



**Montagem da mola de montagem (6 un.)**  
Aço  
C: 2 cm | L: 1 cm | A: 2,5 cm

Cinzento Art. n.º **145551** **13,20 EUR**



**Conector em L, terra interior, com opção de alimentação**  
16A máx. | Plástico/Aço  
C: 16 cm | L: 16 cm | A: 3,2 cm

Branco Art. n.º **1001537** **78,00 EUR**



**Adaptador da calha eletrificada trif.**  
Plástico  
C: 9,6 cm | L: 3,5 cm | A: 4,5 cm  
Carga mecânica máx.: 5 kg

Branco Art. n.º **1001542** **19,70 EUR**

1007655 543





TS V  
Trif.

TS V  
Trif.

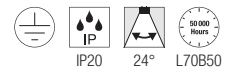
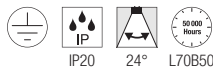
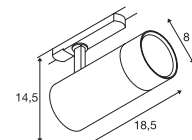
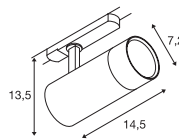

220-240V ~50/60Hz | 250/350/500mA  
Potência total: 20W  
Material: alumínio / policarbonato (PC)

220-240V ~50/60Hz | 600/750/mA  
Potência total: 35W  
Material: alumínio / policarbonato (PC)



Down	1800lm	2700K
	1980lm	3000K
	1920lm	4000K

Down	3090lm	2700K
	3470lm	3000K
	3300lm	4000K

Variante	Art. n.º	EUR
● Preto	1007655	159,00
○ Branco	1007654	159,00

Variante	Art. n.º	EUR
● Preto	1007657	179,00
○ Branco	1007656	179,00

1007646 545







NOBLO® SPOT  
Trif., PHASE

NOBLO® SPOT  
Trif., PHASE

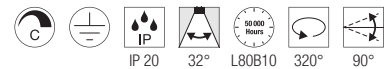
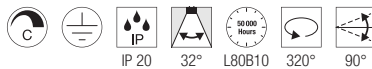
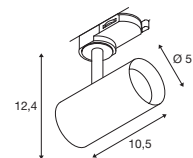
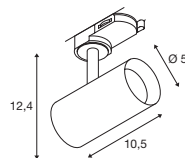

220-240V ~50/60Hz | 150mA  
Potência total: 6,2W  
Material: alumínio / policarbonato (PC)

220-240V ~50/60Hz | 150mA  
Potência total: 6,2W  
Material: alumínio / policarbonato (PC)



Down 740lm | 2700K

Down 750lm | 3000K

Variante	Art. n.º	EUR
● Preto	1007644	75,00
○ Branco	1007645	75,00

Variante	Art. n.º	EUR
● Preto	1007646	75,00
○ Branco	1007647	75,00

1007649 547





**NOBLO® SPOT**  
Trif., PHASE

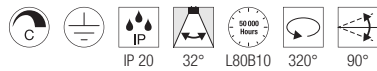
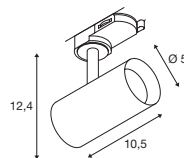

220-240V ~50/60Hz | 150mA  
Potência total: 6,2W  
Material: alumínio / policarbonato (PC)



Down 760lm | 4000K

Variante	Art. n.º	EUR
● Preto	1007648	75,00
○ Branco	1007649	75,00

**NOBLO® SPOT**  
Trif., PHASE

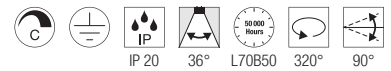
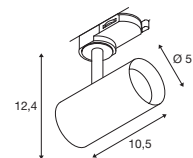

220-240V ~50/60Hz | 350mA  
Potência total: 8,4W  
Material: alumínio / policarbonato (PC)



Down 30lm | 2000K - 450lm | 3000K

Variante	Art. n.º	EUR
● Preto	1007355	90,00
○ Branco	1007356	90,00

1007597 549

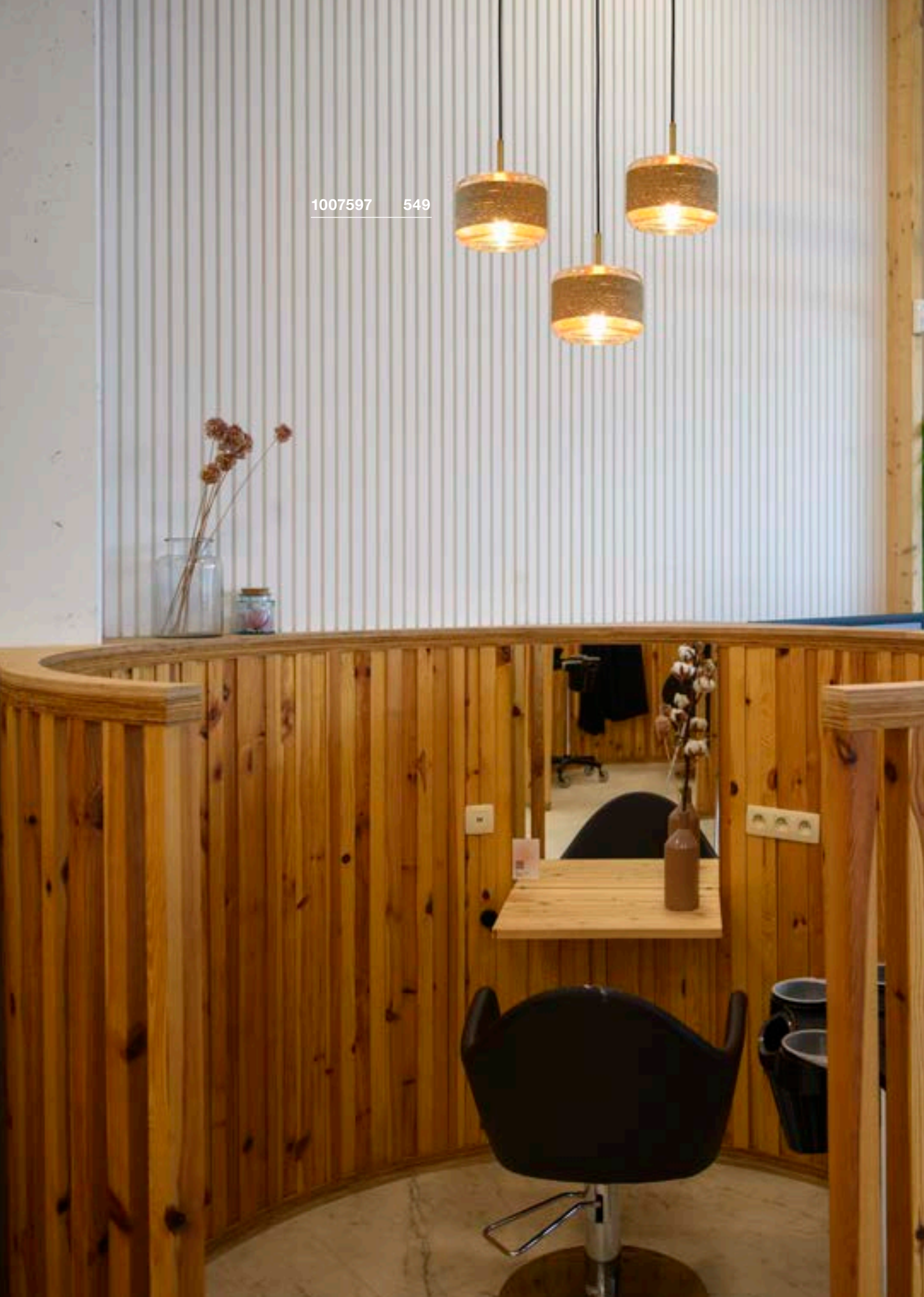



## PANTILO ROPE 19 PD, E27

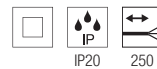
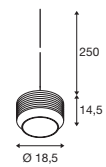

200-240V ~50/60Hz  
Material: vidro / aço / cânhamo

- Extremidade do cabo aberta

**SECRET INSIDE** <15 W

Base: 1xE27 Máx. Ø: 10 cm | C: 11 cm

Variante	Art. n.º	EUR
● Âmbar/dourado	<b>1007597</b>	● <b>199,00</b>
● Antracite/prateado	<b>1007596</b>	● <b>199,00</b>



A60 | 7,5W | 180°  
2700K | 720lm | EE=F  
8kWh/1000h



Art. N.º: **1005305** | **19,00 EUR**

## SIGHT TRACK Trif., DALI

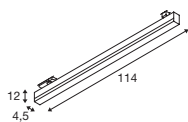

220-240V ~50/60Hz | 700mA  
Potência total: 39W  
Material: alumínio/acrílico



Down 3000lm | 3000K | 3000lm | 4000K

Variante	Art. n.º	EUR
● Preto	1005397	375,00
○ Branco	1005399	375,00

## SIGHT TRACK Trif.

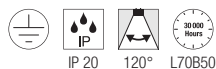
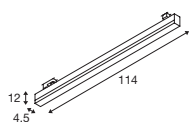

220-240V ~50/60Hz | 700mA  
Potência total: 37W  
Material: alumínio/acrílico



Down 3000lm | 3000K | 3000lm | 4000K

Variante	Art. n.º	EUR
● Preto	1005400	309,00
○ Branco	1005401	309,00
● Cinzento	1005402	309,00

1005400 550





1005399 551

### SIGHT MOVE Trif., DALI

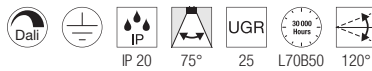
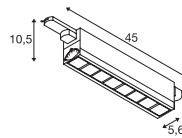

220-240V ~50/60Hz | 350mA  
Potência total: 26W  
Material: alumínio/polimetilacrilato (PMMA)



Down 2700lm | 3000K  
3100lm | 4000K

Variante	Art. n.º	EUR
● Preto 2700lm   3000K	1004690	255,00
○ Branco 2700lm   3000K	1004691	255,00
● Preto 3100lm   4000K	1004692	255,00
○ Branco 3100lm   4000K	1004693	255,00

### SIGHT MOVE Trif.

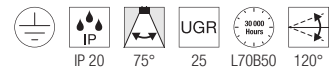
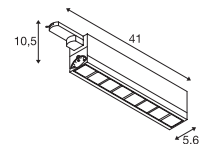

220-240V ~50/60Hz | 350mA  
Potência total: 26W  
Material: alumínio/polimetilacrilato (PMMA)



Down 2700lm | 3000K  
3100lm | 4000K

Variante	Art. n.º	EUR
● Preto 2700lm   3000K	1004686	182,00
○ Branco 2700lm   3000K	1004687	182,00
● Preto 3100lm   4000K	1004688	182,00
○ Branco 3100lm   4000K	1004689	182,00

PARA CONE GL  
Trif., GU10

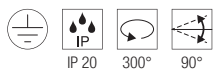
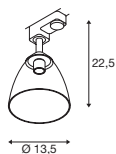

220-240V ~50/60Hz  
Material: alumínio/vidro



Base: 1xGU10

Variante	Art. n.º	EUR
● Preto	1006157	102,00
○ Branco	1006158	102,00



LED GU10 51mm | 3,2W  
2700K | 270lm | EE=G



Art. N.º: 1006321 | 48,00 EUR

PARA CONE GL  
PD, GU10

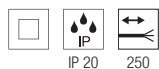
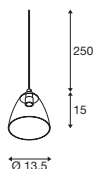

220-240V ~50/60Hz  
Material: alumínio/vidro

- Extremidade do cabo aberta



Base: 1xGU10

Variante	Art. n.º	EUR
● Preto	1006159	84,00
○ Branco	1006160	84,00



LED GU10 51mm | 3,2W  
2700K | 270lm | EE=G



Art. N.º: 1006321 | 48,00 EUR

1006157 552

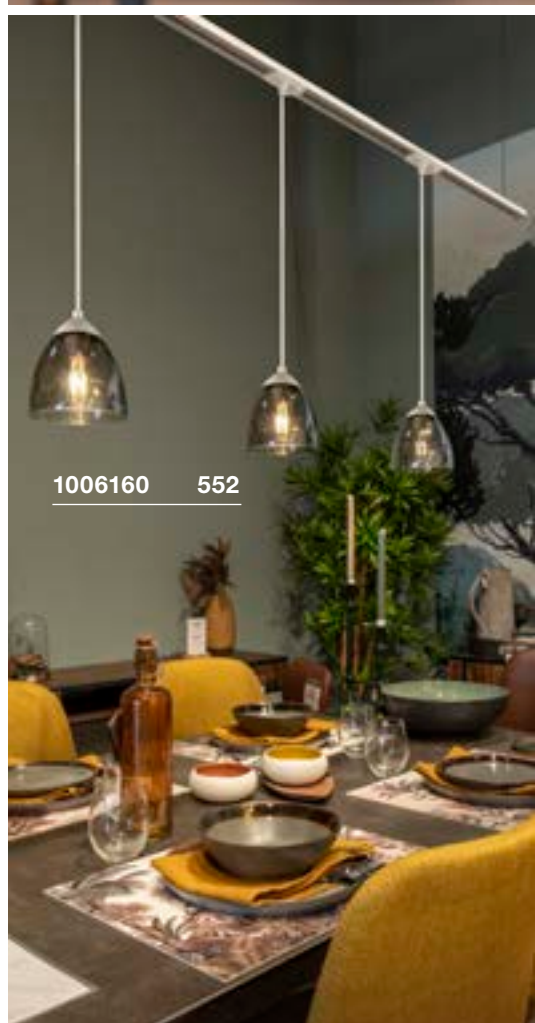

1006160 552





PARA CONE 14  
Trif., QPAR51

PARA CONE 14  
Trif., PD, QPAR51

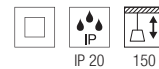
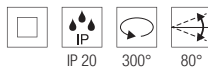
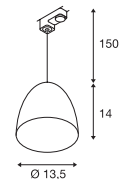
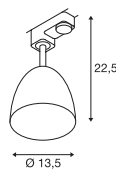

220-240V ~50/60Hz  
Material: aço

220-240V ~50/60Hz  
Material: alumínio

- Versão preto/dourado com refletor dourado
- Todas as outras versões com refletor branco



Base: 1xGU10

Base: 1xGU10

Variante	Art. n.º	EUR
● Preto	1002876	86,00
○ Branco	1002877	86,00
● Cobre	1002878	89,00

Variante	Art. n.º	EUR
● Preto	153140	117,00
○ Branco	153141	117,00
● Cobre	1002686	124,00



LED GU10 51mm | 3,2W  
2700K | 270lm | EE=G



Art. N.º: 1006321 | 48,00 EUR



LED GU10 51mm | 3,2W  
2700K | 270lm | EE=G



Art. N.º: 1006321 | 48,00 EUR



153141 553

FORCHINI M 40 TRACK  
Trif., PD, E27

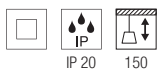
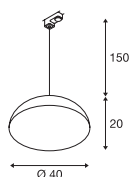

220-240V ~50/60Hz  
Material: alumínio/aço



Base: 1xE27 Máx. Ø: 6,8 cm C: 15,2 cm

Variante	Art. n.º	EUR
● Preto/dourado	153130	233,00



A60 | 7,5W | 180°  
2700K | 720lm | EE=F  
8kWh/1000h



Art. N.º: 1005305 | 19,00 EUR

153130

554



152750

555





**EURO CUBE**  
Trif.

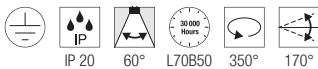
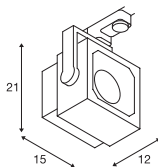

220-240V ~50/60Hz  
Potência total: 26W  
Material: alumínio



Down  
2470lm | 3000K  
2740lm | 4000K

Variante	Art. n.º	EUR
● Preto 2470lm   3000K	<b>152750</b>	<b>260,00</b>
○ Branco 2470lm   3000K	<b>152751</b>	<b>260,00</b>
● Preto 2740lm   4000K	<b>152780</b>	<b>260,00</b>
○ Branco 2740lm   4000K	<b>152781</b>	<b>260,00</b>

**EURO SPOT TRACK**  
Trif., QPAR111

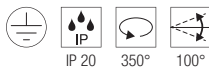
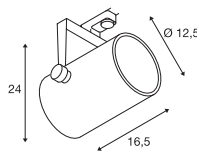

220-240V ~50/60Hz  
Material: alumínio



Base: 1xGU10

Variante	Art. n.º	EUR
● Preto	<b>153420</b>	<b>106,00</b>
○ Branco	<b>153421</b>	<b>106,00</b>



QPAR111 | 12,5W | 30°  
2700K | 950lm | EE=F  
13kWh/1000h



Art. N.º: **1005276** | **49,50 EUR**

**EURO SPOT TRACK**  
Trif., QPAR51

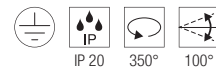
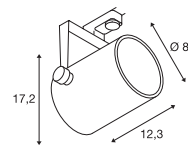

220-240V ~50/60Hz  
Material: alumínio



Base: 1xGU10

Variante	Art. n.º	EUR
● Preto	<b>153850</b>	<b>84,00</b>
○ Branco	<b>153851</b>	<b>84,00</b>



LED GU10 51mm | 6W | 38°  
2700K | 450lm | EE=F  
6kWh/1000h



Art. N.º: **1005077** | **7,50 EUR**

ALTRA DICE TRACK  
Trif., QPAR51

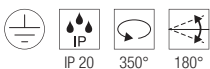
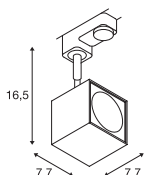

220-240V ~50/60Hz  
Material: alumínio



Base: 1xGU10 Máx. Ø: 5,1 cm C: 5,7 cm

Variante	Art. n.º	EUR
● Preto	152320	96,00
○ Branco	152321	96,00



LED GU10 51mm | 6W | 36°  
2200-2700K | 360lm | EE=G  
6kWh/1000h



Art. N.º: 1005273 | 9,99 EUR

152320 556





153560 557

**PURI TRACK**  
Trif., QPAR51

**PURI TRACK GLASS**  
Trif., QPAR51

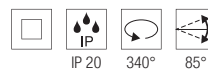
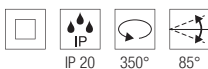
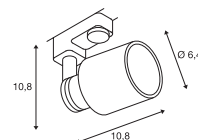
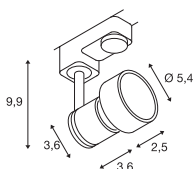

220-240V ~50/60Hz  
Material: alumínio / policarbonato (PC)

220-240V ~50/60Hz  
Material: alumínio/plástico

• Anel decorativo incl.



Base: 1xGU10

Base: 1xGU10

Variante	Art. n.º	EUR
● Preto	153560	35,75
○ Branco	153561	35,75
● Cinzento	153564	35,75

Variante	Art. n.º	EUR
● Preto	1001871	45,00
○ Branco	1001872	45,00



LED GU10 51mm | 6W | 38°  
2700K | 450lm | EE=F  
6kWh/1000h



Art. N.º: 1005075 | 7,50 EUR



LED GU10 51mm | 6W | 38°  
2700K | 450lm | EE=F  
6kWh/1000h



Art. N.º: 1005077 | 7,50 EUR

**KALU TRACK LED**  
Trif., PHASE

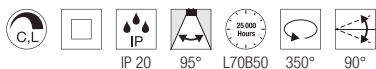
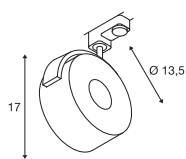

220-240V ~50/60Hz  
Potência total: 13W  
Material: alumínio



Down 970lm | 3000K

Variante	Art. n.º	EUR
● Preto	152600	219,00
○ Branco	152601	219,00

**KALU TRACK**  
Trif., QPAR111

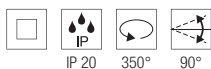
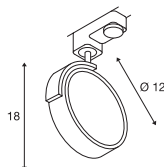

220-240V ~50/60Hz  
Material: alumínio/plástico



Base: 1xGU10

Variante	Art. n.º	EUR
● Preto	152610	89,00
○ Branco	152611	89,00



QPAR111 | 12,5W | 10°  
3000K | 950lm | EE=F  
13kWh/1000h



Art. N.º: 1005278 | 55,00 EUR

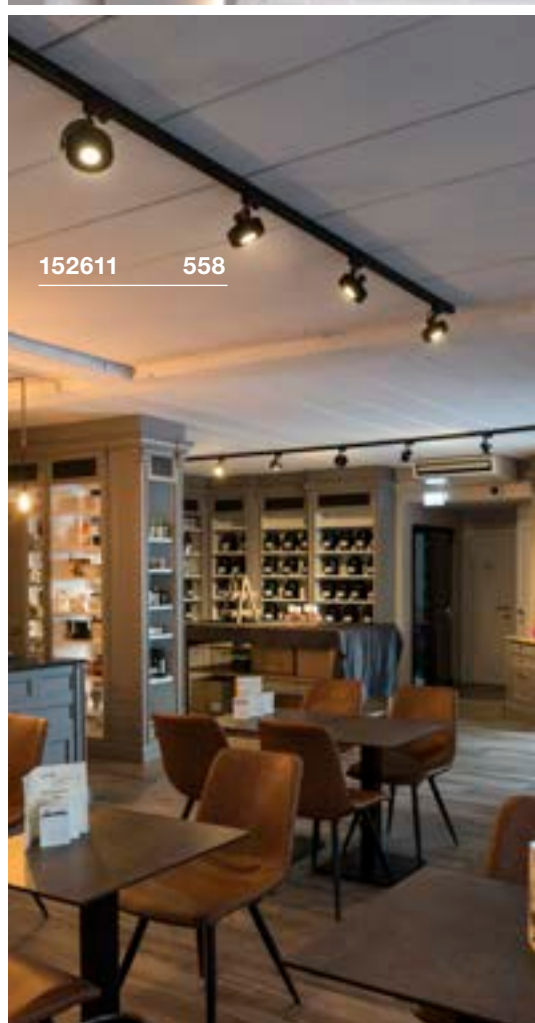

152611 558



**BIMA**  
Trif., single, QPAR51

**BIMA**  
Trif., double, QPAR51

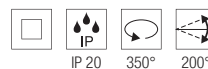
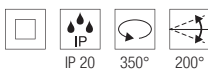
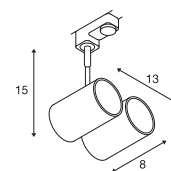
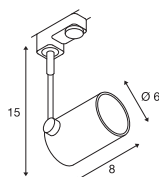

220-240V ~50/60Hz  
Material: alumínio

220-240V ~50/60Hz  
Material: alumínio

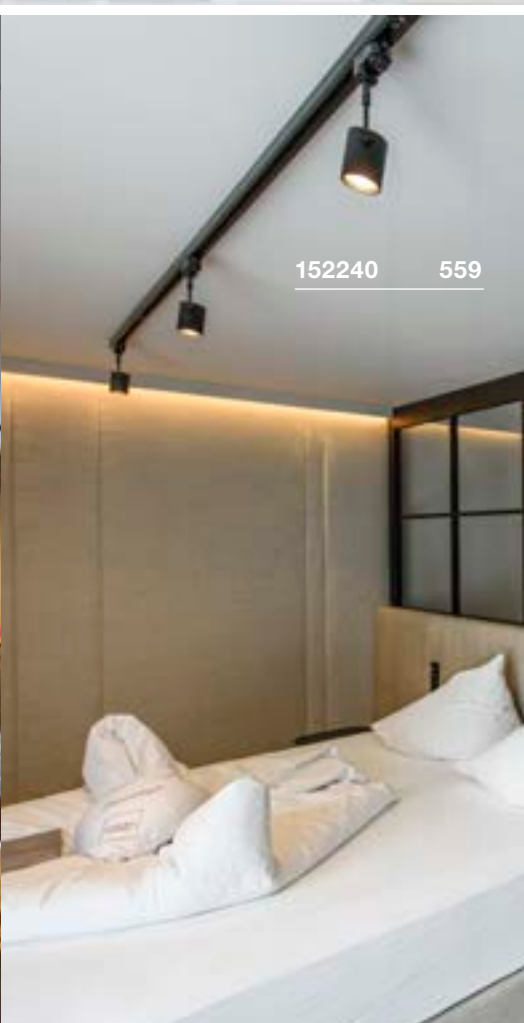

Base: 1xGU10 Máx. Ø: 5,1 cm C: 5,7 cm

Base: 2xGU10 Máx. Ø: 5,1 cm C: 5,7 cm

Variante	Art. n.º	EUR
● Preto	152240	45,00
○ Branco	152241	45,00
● Cinzento	152242	45,00

Variante	Art. n.º	EUR
● Preto	152230	70,00
○ Branco	152231	70,00
● Cinzento	152232	70,00



LED GU10 51mm | 6W | 38°  
2700K | 450lm | EE=F  
6kWh/1000h



Art. N.º: 1005077 | 7,50 EUR



LED GU10 51mm | 6W | 38°  
2700K | 450lm | EE=F  
6kWh/1000h



Art. N.º: 1005075 | 7,50 EUR



152960 561



152430 561





### HELIA 50 TRACK Trif.

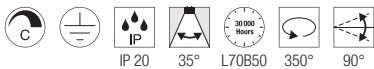
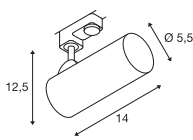

220-240V ~50/60Hz | 500mA  
Potência total: 11W  
Material: alumínio



Down 810lm | 3000K  
880lm

Variante	Art. n.º	EUR
● Preto		
810 lm	<b>152960</b>	<b>90,00</b>
○ Branco		
880 lm	<b>152961</b>	<b>90,00</b>

### ENOLA C TRACK Trif.

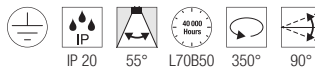
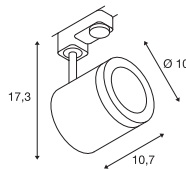

220-240V ~50/60Hz | 500mA  
Potência total: 11W  
Material: alumínio



Down 1040lm | 3000K

Variante	Art. n.º	EUR
● Preto	<b>152430</b>	<b>177,00</b>
○ Branco	<b>152431</b>	<b>177,00</b>

### AVO TRACK Trif., QPAR51

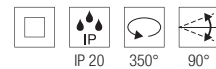
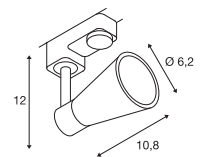

220-240V ~50/60Hz  
Material: aço



Base: 1xGU10 Máx. Ø: 5,1 cm

Variante	Art. n.º	EUR
● Preto	<b>152640</b>	<b>44,50</b>
○ Branco	<b>152641</b>	<b>44,50</b>



LED GU10 51mm | 6W | 38°  
2700K | 450lm | EE=F  
6kWh/1000h



Art. N.º: **1005077** | **7,50 EUR**

# PERSONALIZE A SUA CALHA ELETRIFICADA

---

Construção profissional: uma iluminação bem pensada é essencial, especialmente onde há muito para ver. Por serem luminárias que podem ser utilizadas de forma flexível na calha eletrificada, permitem iluminar perfeitamente os objetos desejados. O conceito de iluminação pode ser alterado em qualquer momento. As calhas eletrificadas trifásicas (3 circuitos de 230V AC) são ideais para lojas e stands de exposição. Em conjunto com as luminárias SLV adequadas, permitem criar o ambiente perfeito e colocam produtos e peças de exposição na luz certa. As calhas eletrificadas monofásicas são particularmente adequadas às casas particulares e enchem as divisões com uma luz acolhedora. As calhas eletrificadas de alumínio podem ser fácil e rapidamente fixadas no teto, graças às aberturas disponíveis no perfil. Pode escolher entre uma versão encastrada e uma versão saliente, disponíveis em várias cores.

## SELECIONE A(S) SUA(S) ...

- 1 calha(s) eletrificada(s)  
(S-TRACK, EUTRAC, sistema monofásico)
- 2 Tipo de montagem  
(calha eletrificada para encastrar/saliente)
- 3 Luminária
- 4 Opções de configuração



JÁ ESTÁ!

# SISTEMAS DE CALHAS ELETRIFICADAS

**S-TRACK**  
Sistema trifásico



**EUTRAC**  
Sistema trifásico



**SISTEMA MONOFÁSICO**



Calha eletrificada  
encastrada



Calha eletrificada  
saliente



Teto



Parede



Suspensa

Opções de colocação

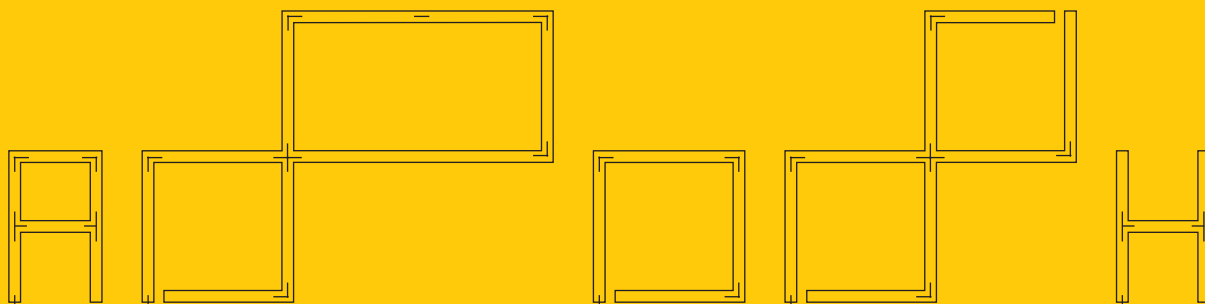

Diferentes opções de configuração, individualmente adaptadas ao seu espaço

Utilize também o nosso configurador Track [slv.com](https://www.slv.com)



PERFIS



GRAZIA 10 PERFIL SALIENTE | 567



GRAZIA 10 PERFIL PARA ENCASTRAR | 567



GRAZIA 10 EDGE | 570

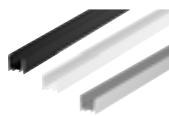

GRAZIA 20 PERFIL SALIENTE | 573



GRAZIA 20 PERFIL PARA ENCASTRAR | 573



GRAZIA 60 PERFIL SALIENTE | 577

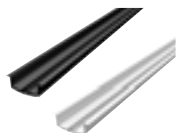

GRAZIA 60 PERFIL PARA ENCASTRAR | 577



GRAZIA 10 ACESSÓRIOS | 569



GRAZIA 10 EDGE ACESSÓRIOS | 571



GRAZIA 20 ACESSÓRIOS | 574-575



GRAZIA 60 ACESSÓRIOS | 578-579

TIRAS DE LED



GRAZIA FLEXSTRIP LED | 582



GRAZIA PRO FLEXSTRIP LED | 583



GRAZIA PRO MAX FLEXSTRIP | 585



GRAZIA PRO FLEXSTRIP TUNABLE WHITE | 587



GRAZIA PRO FLEXSTRIP RGBW | 589



GRAZIA IP FLEXSTRIP | 591



GRAZIA FLEXSTRIP LED ACESSÓRIOS | 582



GRAZIA PRO FLEXSTRIP LED ACESSÓRIOS | 583



GRAZIA PRO MAX FLEXSTRIP ACESSÓRIOS | 585



GRAZIA PRO FLEXSTRIP TUNABLE WHITE ACESSÓRIOS | 587



GRAZIA PRO FLEXSTRIP RGBW ACESSÓRIOS | 589



### GRAZIA 10

Perfil saliente, reduzido

Material: alumínio,  
Largura: 1,75 cm, altura: 1,1 cm,  
Máx. Largura fita LED em mm: 10  
Não inclui Difusor

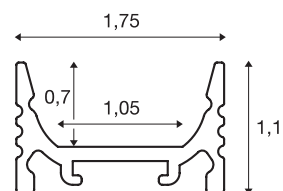

Comprimento (cm)	Cor	Material	Art. n.º	EUR
200	● Preto	Alumínio	1000462	29,00
	○ Branco		1000461	29,00

### GRAZIA 10

Perfil saliente, elevado

Material: alumínio  
Largura: 1,75 cm, altura: 1,62 cm  
Máx. Largura fita LED em mm: 10  
Não inclui Difusor

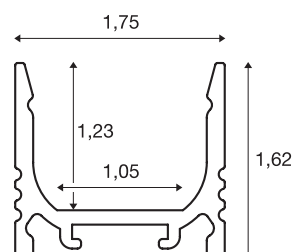

Comprimento (cm)	Cor	Material	Art. n.º	EUR
200	● Preto	Alumínio	1000465	29,00
	○ Branco		1000464	29,00

### GRAZIA 10

Perfil para encastrar

Material: alumínio  
Largura: 3 cm, altura: 1,62 cm  
Máx. Largura fita LED em mm: 10  
Não inclui Difusor

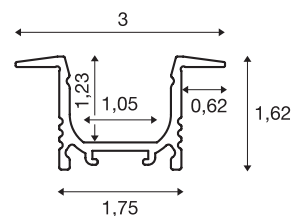

Comprimento (cm)	Cor	Material	Art. n.º	EUR
200	● Preto	Alumínio	1000459	32,00
	○ Branco		1000458	32,00





# ACESSÓRIOS

## GRAZIA 10 Difusor



Descrição	Cor	Comprimento (cm)	Largura (cm)	Altura (cm)	Material	Art. n.º	EUR
Difusor	<input type="radio"/> Fosco	200	1,58	0,4	Policarbonato (PC)	1000466	18,00
	<input type="radio"/> Leitoso				Polimetilacrilato (PMMA)	1000468	24,00
	<input type="radio"/> Acetinado					1000469	24,00

## GRAZIA 10 Acessórios de montagem



Descrição	Cor	Largura (cm)	Altura (cm)	Profundidade (cm)	Material	Art. n.º	EUR
Acessórios de montagem	<input type="radio"/> Prateado, 45°	1,62	1,62	1	Aço	1000489	5,40
	<input checked="" type="radio"/> Aço inoxidável, não visível	1,53	0,3	1	Aço inoxidável	1000487	4,30

Unidade embalada: 2 unidades

## GRAZIA 10 Tampas para perfil saliente

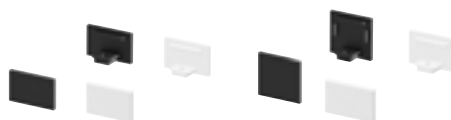

Descrição	Cor	Comprimento (cm)	Largura (cm)	Altura (cm)	Material	Art. n.º	EUR
Tampas	<input checked="" type="radio"/> Preto, liso	-	1,75	1,1	Alumínio	1000477	6,85
	<input type="radio"/> Branco, liso			1,1		1000476	6,85
Tampas	<input checked="" type="radio"/> Preto, padrão	-	1,75	1,62	Alumínio	1000480	6,85
	<input type="radio"/> Branco, padrão			1,62		1000479	6,85

Unidade embalada: 2 unidades

## GRAZIA 10 Tampas para perfil de encastrar



Descrição	Cor	Comprimento (cm)	Largura (cm)	Altura (cm)	Material	Art. n.º	EUR
Tampas	<input checked="" type="radio"/> Preto	-	3	1,62	Alumínio	1000474	6,85
	<input type="radio"/> Branco					1000473	6,85

Unidade embalada: 2 unidades



## GRAZIA 10 EDGE

2 m

Material: alumínio  
 Largura: 1,95 cm, altura: 1,95 cm  
 Máx. Largura fita LED em mm: 10  
 Não inclui difusor

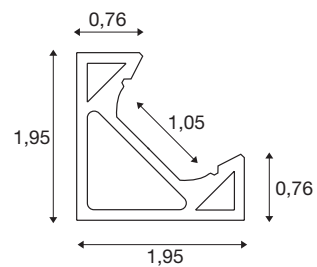
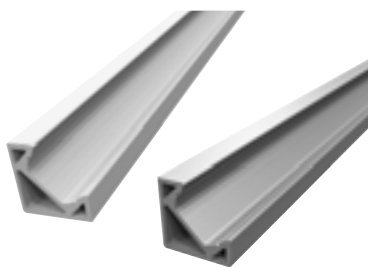

Comprimento (cm)	Cor	Material	Art. n.º	EUR
200	<input type="radio"/> Branco	Alumínio	1004890	39,00
	<input checked="" type="radio"/> Alumínio		1004889	39,00

# ACESSÓRIOS

## GRAZIA 10 EDGE Difusor



Descrição	Cor	Comprimento (cm)	Largura (cm)	Altura (cm)	Material	Art. n.º	EUR
Difusor	<input type="radio"/> Fosco	200	1,58	0,4	Policarbonato (PC)	1000466	18,00
	<input type="radio"/> Leitoso				Polimetilacrilato (PMMA)	1000468	24,00
	<input type="radio"/> Acetinado					1000469	24,00

## GRAZIA 10 EDGE Tampa



Descrição	Cor	Comprimento (cm)	Largura (cm)	Altura (cm)	Material	Art. n.º	EUR
Tampa	<input type="radio"/> Branco	2	0,7	2	ABS	1004894	2,25
	<input checked="" type="radio"/> Alumínio					1004893	2,25

Unidade embalada: 2 unidades

## GRAZIA 10 EDGE Acessórios de montagem



Descrição	Cor	Comprimento (cm)	Largura (cm)	Altura (cm)	Material	Art. n.º	EUR
Acessórios de montagem	<input checked="" type="radio"/> Aço inoxidável	2,25	15	2,25	Aço	1004895	4,25

Unidade embalada: 4 unidades



### GRAZIA 20

Perfil de instalação saliente padrão,  
3 m

Material: alumínio  
Largura: 3,5 cm, altura: 3,2 cm  
Máx. Largura fita LED em mm: 20  
Não inclui difusor

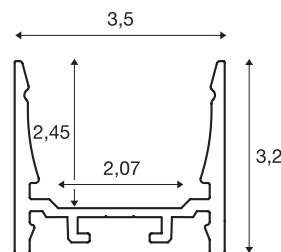
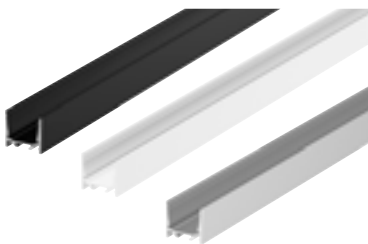

Comprimento (cm)	Cor	Material	Art. n.º	EUR
300	● Preto	Alumínio	1000525	89,00
	○ Branco		1000524	89,00
	● Alumínio		1000523	89,00

### GRAZIA 20

Perfil saliente, liso, 3 m

Material: alumínio  
Largura: 3,5 cm, altura: 2,2 cm  
Máx. Largura fita LED em mm: 20  
Não inclui difusor

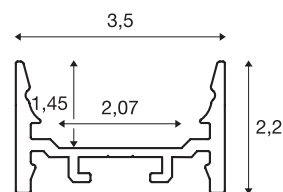

Comprimento (cm)	Cor	Material	Art. n.º	EUR
300	● Preto	Alumínio	1000534	75,00
	○ Branco		1000533	75,00

### GRAZIA 20

Perfil de encastrar, 3 m

Material: alumínio  
Largura: 5,2 cm, altura: 3,2 cm  
Máx. Largura fita LED em mm: 20  
Não inclui difusor

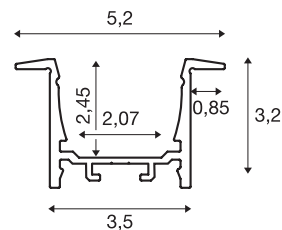

Comprimento (cm)	Cor	Material	Art. n.º	EUR
300	● Preto	Alumínio	1000498	105,00
	○ Branco		1000497	105,00

# ACESSÓRIOS

## GRAZIA 20 Difusor, 3 m, lisa



Descrição	Cor	Comprimento (cm)	Largura (cm)	Altura (cm)	Material	Art. n.º	EUR
Difusor	<input type="radio"/> Fosco	300	3,2	0,6	Policarbonato (PC)	1000540	41,50
	<input type="radio"/> Fosco				Polimetilacrilato (PMMA)	1000546	41,50
	<input type="radio"/> Leitoso					1000549	41,50

## GRAZIA 20 Conector longitudinal



Descrição	Cor	Comprimento (cm)	Largura (cm)	Altura (cm)	Material	Art. n.º	EUR
Conector longitudinal	<input checked="" type="radio"/> Alumínio	3,8	1,4	0,4	Alumínio	1000571	12,00

Unidade embalada: 2 unidades

## GRAZIA 20 Tampas para perfil saliente

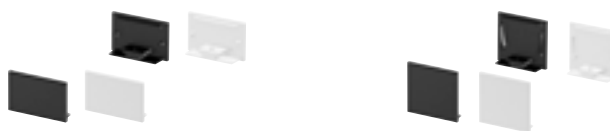

Descrição	Cor	Comprimento (cm)	Largura (cm)	Altura (cm)	Material	Art. n.º	EUR
Tampa	<input checked="" type="radio"/> Preto, liso	-	3,5	2,2	Alumínio	1000561	9,25
	<input type="radio"/> Branco, liso					1000560	9,25
Tampa	<input checked="" type="radio"/> Preto, padrão	-	3,5	3,2	Alumínio	1000567	9,25
	<input type="radio"/> Branco, padrão					1000566	9,25

Unidade embalada: 2 unidades

**GRAZIA 20**  
Tampa para perfil de encastrar



Descrição	Cor	Comprimento (cm)	Largura (cm)	Altura (cm)	Material	Art. n.º	EUR
Tampa	<input checked="" type="radio"/> Preto	-	5,2	3,2	Alumínio	1000558	9,25
	<input type="radio"/> Branco					1000557	9,25

Unidade embalada: 2 unidades

**GRAZIA 20**  
Estrutura suspensa



Descrição	Cor	Comprimento (cm)	Material	Art. n.º	EUR
Estrutura suspensa	<input type="radio"/> Prateado	200	Aço	1000535	27,25

Unidade embalada: 2 unidades

**GRAZIA 20**  
Acessórios de montagem



Descrição	Cor	Comprimento (cm)	Largura (cm)	Altura (cm)	Material	Art. n.º	EUR
Acessório de montagem	<input type="radio"/> Prateado	2	3	0,8	Aço	1000536	4,00
Acessório de montagem	<input checked="" type="radio"/> Cromado/alumínio	5,5	7	2,3	Aço/alumínio	1004932	22,00

Unidade embalada: 2 unidades





## GRAZIA 60

### Perfil saliente

Material: alumínio  
 Largura: 7 cm, altura: 9,5 cm  
 Máx. Largura fita LED em mm: 20  
 Não inclui difusor

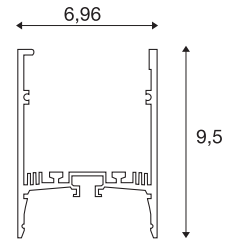
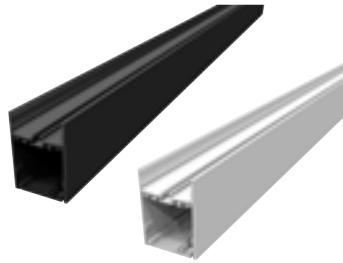

Comprimento (cm)	Cor	Material	Art. n.º	EUR
150	● Preto	Alumínio	1004896	107,00
150	○ Branco		1004897	107,00
300	● Preto	Alumínio	1004898	220,00
300	○ Branco		1004899	220,00

## GRAZIA 60

### Perfil de encastrar, 1,5 m

Material: alumínio  
 Largura: 8,6 cm, altura: 3,3 cm  
 Máx. Largura fita LED em mm: 20  
 Não inclui difusor

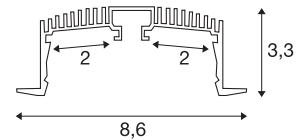
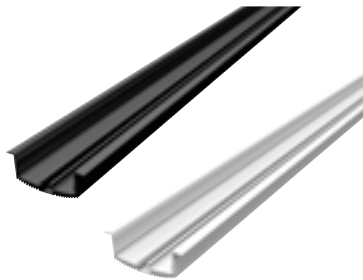

Comprimento (cm)	Cor	Material	Art. n.º	EUR
150	● Preto	Alumínio	1004905	67,00
150	○ Branco		1004906	67,00
300	● Preto	Alumínio	1004907	133,00
300	○ Branco		1004908	133,00

# ACESSÓRIOS

## GRAZIA 60 Difusor, 1,5 m



Descrição	Cor	Comprimento (cm)	Largura (cm)	Altura (cm)	Material	Art. n.º	EUR
Difusor, 1,5 m	<input checked="" type="radio"/> Preto	150	6,5	0,65	Alumínio	1004912	29,00
	<input type="radio"/> Branco					1004913	29,00
	<input type="radio"/> Fosco				Polímetilacrilato (PMMA)	1004914	18,00
	<input type="radio"/> Fosco					1004916	23,00
Difusor, 3 m	<input type="radio"/> Fosco	300	6,5		Polícarbonato (PC)	1004915	35,00
	<input type="radio"/> Fosco				Polímetilacrilato (PMMA)	1004917	44,00

## GRAZIA 60 Tampas

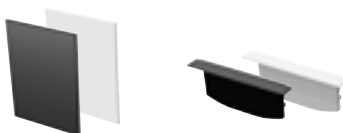

Descrição	Cor	Comprimento (cm)	Largura (cm)	Altura (cm)	Material	Art. n.º	EUR
Tampas perfil saliente	<input checked="" type="radio"/> Preto	-	7	9,5	Alumínio	1004900	12,50
	<input type="radio"/> Branco	-				1004901	12,50
Tampas perfil de encastrar	<input checked="" type="radio"/> Preto	-	8,6	3,3	Alumínio	1004909	8,50
	<input type="radio"/> Branco	-				1004910	8,50

Unidade embalada: 2 unidades

## GRAZIA 60 Perfil para montagem saliente



Descrição	Cor	Comprimento (cm)	Largura (cm)	Altura (cm)	Material	Art. n.º	EUR
Montagem saliente	<input checked="" type="radio"/> Preto	150	6,1	1,2	Alumínio	1004902	35,00

**GRAZIA 60**  
 Perfil saliente,  
 conectores longitudinais



Descrição	Cor	Comprimento (cm)	Largura (cm)	Altura (cm)	Material	Art. n.º	EUR
Conector longitudinal	● Alumínio	8	4,2	1	Alumínio	1004903	12,00

Unidade embalada: 2 unidades

**GRAZIA 60**  
 Perfil saliente, alimentador



Descrição	Cor	Comprimento (cm)	Largura (cm)	Altura (cm)	Material	Art. n.º	EUR
Alimentador	● Alumínio	8	4,2	2,4	Alumínio	1004904	13,00

**GRAZIA 60**  
 Perfil de encastrar,  
 conjunto de fixação



Descrição	Cor	Comprimento (cm)	Largura (cm)	Altura (cm)	Material	Art. n.º	EUR
Conjunto de fixação	● Cromado	13	2,8	4	Alumínio	1004911	15,25

Unidade embalada: 2 unidades

**CONTROLADOR**  
 Fita LED CCT/RGBW



Descrição	Cor	Comprimento (cm)	Largura (cm)	Altura (cm)	Material	Art. n.º	EUR
Controlador	○ Branco	14,5	4,65	1,6	Policarbonato (PC)	1006348	80,00

# CRIE O SEU PERFIL LED

---

Dê o seu toque pessoal ou ilumine salas inteiras –  
Possibilidade de 700 a 4280 lm/m.

---

Adicione cor – Tiras de led nas versões: branco,  
regulação de brancos (tunable white) ou RGBW.

---

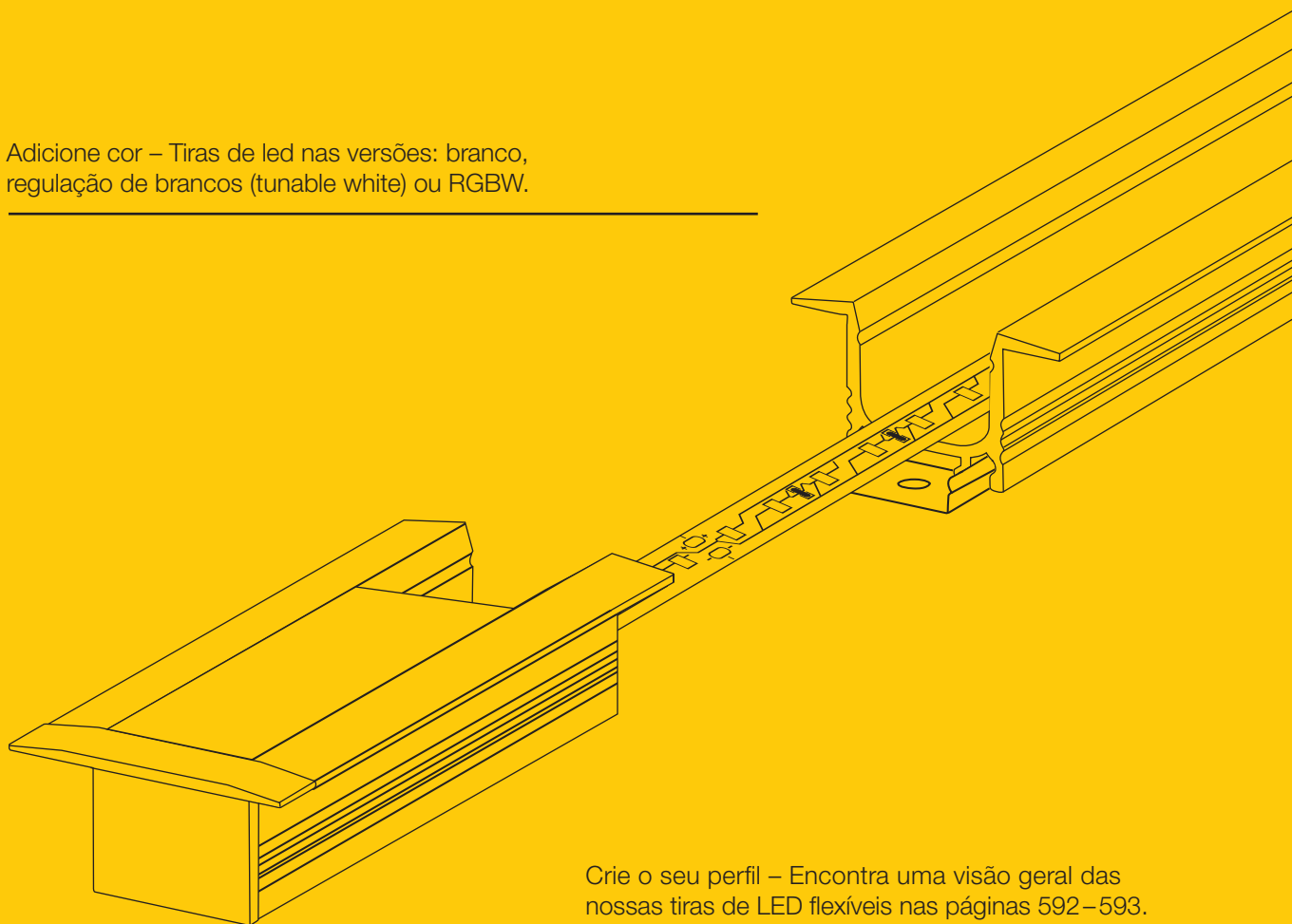

Crie o seu perfil – Encontra uma visão geral das  
nossas tiras de LED flexíveis nas páginas 592–593.  
Para tal, apresentamos-lhe controladores adequados  
nas páginas de acessórios 866–881.

---



Recomendamos-lhe uma nova instalação elétrica nos dois lados, com um comprimento a partir de 3 e 5 m

Difusores foscos, leitosos ou transparentes, versão reduzida ou elevada – Escolha entre os diferentes difusores para uma maior personalização.

---

Para interiores, exteriores ou zonas húmidas. Equipado para todas as aplicações com IP20 e IP54.

---

Quer seja perfil reduzido ou elevado, de encastrar ou de canto – Temos o perfil adequado ao seu projeto.

---

Comprimentos entre 5 m e 80 m, a nossa proposta não conhece limites – aumente ou reduza totalmente a seu gosto. Graças à tecnologia de 24V, abranja longas distâncias com menos pontos de alimentação.

---



## GRAZIA FLEXSTRIP LED 24V

LED por metro: 70  
 Largura: 1 cm  
 Altura: 0,12 cm  
 Distância entre os LED: 1,4 cm  
 Separável a cada: 10 cm  
 Código IP: IP 20  
 Extermidades com cabo de alimentação



Temperatura de cor (K)	Fluxo luminoso (lm)	Performance (W)	Índice de rendimento de cor (IRC)	Consistência da cor (SDCM)	Comprimento (cm)	Art. n.º	EUR
2700	3500	44	90	3	500	1004708	78,00
3000	3500	44				1004709	
4000	3750	44				1004710	



Variante	Material	Comprimento (cm)	Largura (cm)	Altura (cm)	Art. n.º	EUR
○ LED Transformador   50W, triac dim	Policarbonato (PC)	18.4	6.1	3.2	1003104	49,50
○ LED Transformador   25W, triac dim		12.8	5.2	3	1006336	35,00
○ LED Transformador   30W, Slim Line, on/off		30	3	1.6	1007250	50,00
○ LED Transformador   30W, Slim Line, DALI					1007254	60,00
○ LED Transformador   100W, Slim Line, on/off		35	1.8	1007251	80,00	
○ LED Transformador   100W, Slim Line, DALI				1007255	110,00	



## GRAZIA PRO FLEXSTRIP 24V

LED por metro: 126  
 Largura: 1 cm  
 Altura: 0,12 cm  
 Distância entre os LED: 0,8 cm  
 Separável a cada: 5,6 cm  
 Código IP: IP 20  
 Extermidades com cabo de alimentação



Temperatura de cor (K)	Fluxo luminoso (lm)	Performance (W)	Índice de rendimento de cor (IRC)	Consistência da cor (SDCM)	Comprimento (cm)	Art. n.º	EUR
2700	6500	73	90	3	500	1004712	125,00
3000	6500	73				1004713	
4000	7000	73				1004714	



Variante	Material	Comprimento (cm)	Largura (cm)	Altura (cm)	Art. n.º	EUR
<input type="radio"/> LED Transformador   50W, triac dim	Policarbonato (PC)	18.4	6.1	3.2	1003104	49,50
<input type="radio"/> LED Transformador   25W, triac dim		12.8	5.2	3	1006336	35,00
<input type="radio"/> LED Transformador   30W, Slim Line, on/off		30	3	1.6	1007250	50,00
<input type="radio"/> LED Transformador   30W, Slim Line, DALI					1007254	60,00
<input type="radio"/> LED Transformador   100W, Slim Line, on/off		35	1.8	1007251	80,00	
<input type="radio"/> LED Transformador   100W, Slim Line, DALI				1007255	110,00	

Para garantir a dissipação de calor, as Tiras de led devem ser coladas num perfil de alumínio. Parte traseira das Tiras de led com fita adesiva.  
 Para manter uma emissão constante de luz a partir de um comprimento de 3 m, recomendamos alimentar as faixas nos dois lados.  
 A partir de um comprimento de 5 m, deve-se fazer nova alimentação.



## GRAZIA PRO FLEXSTRIP 24V

LED por metro: 168  
 Largura: 1 cm  
 Altura: 0,12 cm  
 Distância entre os LED: 0,6 cm  
 Separável a cada: 4,2 cm  
 Código IP: IP 20  
 Extermidades com cabo de alimentação



Temperatura de cor (K)	Fluxo luminoso (lm)	Performance (W)	Índice de rendimento de cor (IRC)	Consistência da cor (SDCM)	Comprimento (cm)	Art. n.º	EUR
2700	8500	91	90	3	500	1004716	145,00
3000	8500	91				1004717	
4000	9100	91				1004718	
6500	9100	91				1004719	



Variante	Material	Comprimento (cm)	Largura (cm)	Altura (cm)	Art. n.º	EUR
○ LED Transformador   50W, triac dim	Policarbonato (PC)	18.4	6.1	3.2	1003104	49,50
○ LED Transformador   25W, triac dim		12.8	5.2	3	1006336	35,00
○ LED Transformador   30W, Slim Line, on/off		30	3	1.6	1007250	50,00
○ LED Transformador   30W, Slim Line, DALI					1007254	60,00
○ LED Transformador   100W, Slim Line, on/off		35	1.8	1007251	80,00	
○ LED Transformador   100W, Slim Line, DALI				1007255	110,00	





## GRAZIA PRO MAX FLEXSTRIP 24V

LED por metro: 196  
 Largura: 2 cm  
 Altura: 0,15 cm  
 Distância entre os LED: 0,5 cm  
 Separável a cada: 3,6 cm  
 Código IP: IP 20  
 Extermidades com cabo de alimentação



Temperatura de cor (K)	Fluxo luminoso (lm)	Performance (W)	Índice de rendimento de cor (IRC)	Consistência da cor (SDCM)	Comprimento (cm)	Art. n.º	EUR
3000	12500	126	90	3	500	1004720	199,00
4000	13000	126				1004721	



Variante	Material	Comprimento (cm)	Largura (cm)	Altura (cm)	Art. n.º	EUR
<input type="radio"/> LED Transformador   150W, Slim Line, on/off	Policarbonato (PC)	35	3	1.8	1007252	100,00
<input type="radio"/> LED Transformador   150W, Slim Line, DALI					1007256	140,00

Para garantir a dissipação de calor, as tiras de led devem ser coladas num perfil de alumínio. Parte traseira das tiras de led com fita adesiva. Para manter uma emissão constante de luz a partir de um comprimento de 3 m, recomendamos alimentar as tiras nos dois lados. A partir de um comprimento de 5 m, deve-se fazer nova alimentação.



## GRAZIA PRO MAX FLEXSTRIP 24V

LED por metro: 196  
 Largura: 2 cm  
 Altura: 0,15 cm  
 Distância entre os LED: 1 cm  
 Separável a cada: 7,1 cm  
 Código IP: IP 20  
 Extermidades com cabo de alimentação



Temperatura de cor (K)	Fluxo luminoso (lm)	Performance (W)	Índice de rendimento de cor (IRC)	Consistência da cor (SDCM)	Comprimento (cm)	Art. n.º	EUR
3000	20000	193	90	3	500	1004722	350,00
4000	21400					1004723	



Variante	Material	Comprimento (cm)	Largura (cm)	Altura (cm)	Art. n.º	EUR
<input type="radio"/> LED Transformador   250W, Slim Line, on/off	Policarbonato (PC)	40	4	2.2	1007253	120,00
<input type="radio"/> LED Transformador   250W, Slim Line, DALI					1007257	160,00



## GRAZIA PRO FLEXSTRIP tunable white, 24V

LED por metro: 224  
 Largura: 1 cm  
 Altura: 0,12 cm  
 Distância entre os LED: 0,9 cm  
 Separável a cada: 6,3 cm  
 Código IP: IP 20  
 Extermidades com cabo de alimentação



Temperatura de cor (K)	Fluxo luminoso (lm)	Performance (W)	Índice de rendimento de cor (IRC)	Consistência da cor (SDCM)	Comprimento (cm)	Art. n.º	EUR
2700-6500	3400-3700	40	90	6	500	1004725	153,00



Variante	Material	Comprimento (cm)	Largura (cm)	Altura (cm)	Art. n.º	EUR
<input type="radio"/> DALI Controller   1 Canal, push-dim	Policarbonato (PC)	11.6	4.2	1.8	1003106	64,00
<input type="radio"/> LED Transformador   60W, DALI, 2 Canal		20.2	5.8	3	1006133	153,00
<input type="radio"/> SMART Controller   1-5 canais, selecionável via DIP		14.5	4.65	1.6	1006348	80,00
<input type="radio"/> LED Transformador   100W, Slim Line, on/off		35	3	1.8	1007251	80,00
<input type="radio"/> LED Transformador   100W, Slim Line, DALI					1007255	110,00

Para garantir a dissipação de calor, as Tiras de led devem ser coladas num perfil de alumínio. Parte traseira das Tiras de led com fita adesiva.  
 Para manter uma emissão constante de luz a partir de um comprimento de 3 m, recomendamos alimentar as tiras nos dois lados.  
 A partir de um comprimento de 5 m, deve-se fazer nova alimentação.



## GRAZIA PRO FLEXSTRIP RGBW, 24V

LED por metro: 70  
 Largura: 1,2 cm  
 Altura: 0,22 cm  
 Distância entre os LED: 1,4 cm  
 Separável a cada: 10 cm  
 Código IP: IP 20  
 Extermidades com cabo de alimentação



Temperatura de cor (K)	Fluxo luminoso (lm)	Performance (W)	Índice de rendimento de cor (IRC)	Consistência da cor (SDCM)	Comprimento (cm)	Art. n.º	EUR
RGB	2500	60	90	6	500	1004727	155,00
W   3000	2050	27					



Variante	Material	Comprimento (cm)	Largura (cm)	Altura (cm)	Art. n.º	EUR
<input type="radio"/> SMART Controller   1-5 canais, seleccionável via DIP	Policarbonato (PC)	14.5	4.65	1.6	1006348	80,00
<input type="radio"/> LED Transformador   100W, Slim Line, on/off		35	3	1.8	1007251	80,00

Para garantir a dissipação de calor, as Tiras de led devem ser coladas num perfil de alumínio. Parte traseira das Tiras de led com fita adesiva.  
 Para manter uma emissão constante de luz a partir de um comprimento de 3 m, recomendamos alimentar as tiras nos dois lados.  
 A partir de um comprimento de 5 m, deve-se fazer nova alimentação.

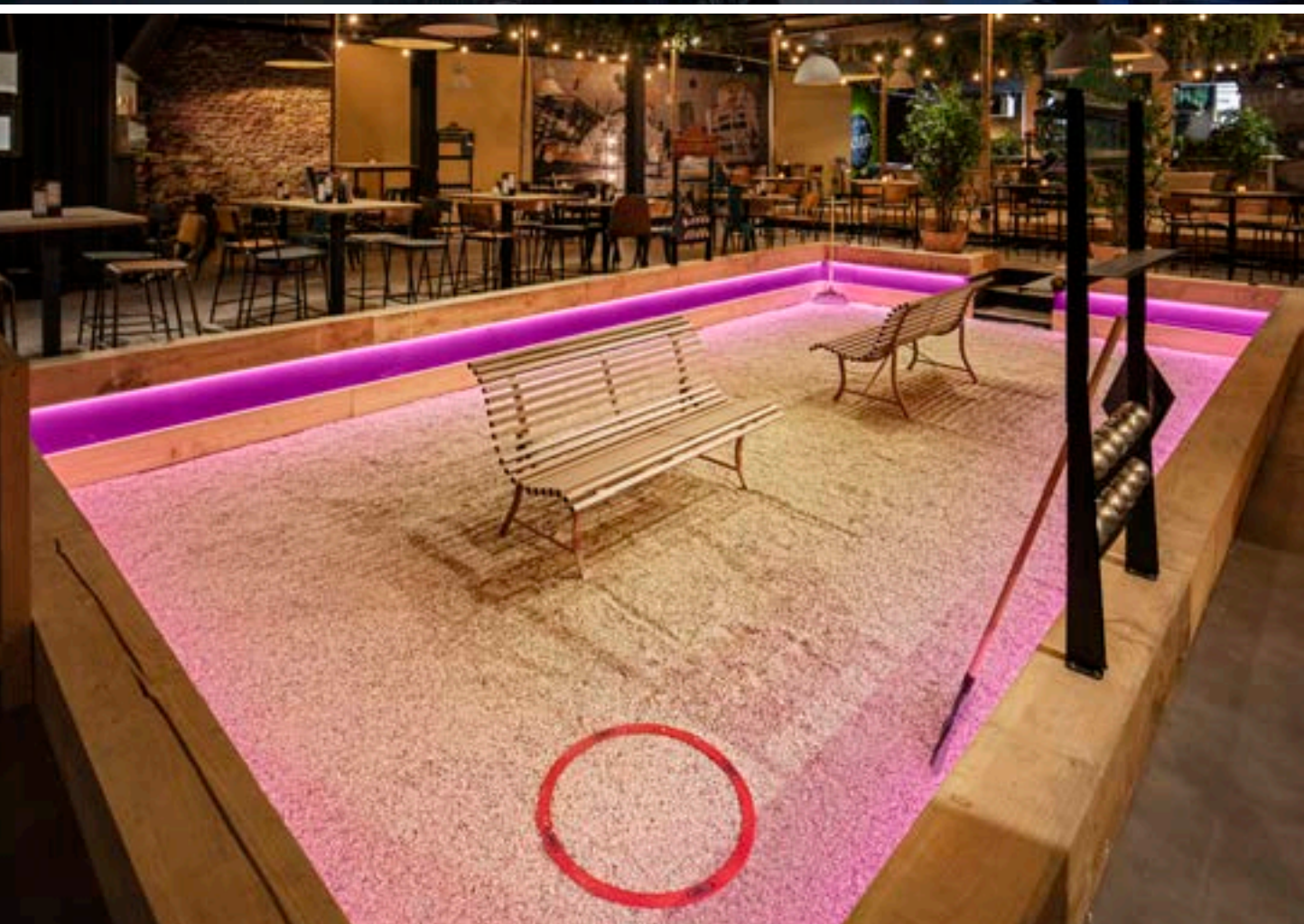

## GRAZIA IP FLEXSTRIP 24V

LED por metro: 70  
Largura: 1,2 cm  
Altura: 0,4 cm  
Distância entre os LED: 1,4 cm  
Separável a cada: 10 cm  
Código IP: IP 54  
Extermidades com cabo de alimentação



Temperatura de cor (K)	Fluxo luminoso (lm)	Performance (W)	Índice de rendimento de cor (IRC)	Consistência da cor (SDCM)	Comprimento (cm)	Art. n.º	EUR
2700	3350					1004734	
3000	3350	44	90	4	502	1004735	99,00
4000	3600					1004736	

## GRAZIA IP FLEXSTRIP tunable white, 24V

LED por metro: 224  
Largura: 1,2 cm  
Altura: 0,4 cm  
Distância entre os LED: 0,9 cm  
Separável a cada: 6,3 cm  
Código IP: IP 54  
Extermidades com cabo de alimentação



Temperatura de cor (K)	Fluxo luminoso (lm)	Performance (W)	Índice de rendimento de cor (IRC)	Consistência da cor (SDCM)	Comprimento (cm)	Art. n.º	EUR
2700-6500	3210-3500	40	90	4	502	1004726	170,00

2 tampas e material de fixação incluídos

## GRAZIA IP FLEXSTRIP RGBW, 24V

LED por metro: 70  
Largura: 1,4 cm  
Altura: 0,46 cm  
Distância entre os LED: 1,4 cm  
Separável a cada: 10 cm  
Código IP: IP 54  
Extermidades com cabo de alimentação



Temperatura de cor (K)	Fluxo luminoso (lm)	Performance (W)	Índice de rendimento de cor (IRC)	Consistência da cor (SDCM)	Comprimento (cm)	Art. n.º	EUR
RGB	2350	60	90	6	502	1004737	210,00
W   3000	1958	27					

Para garantir a dissipação de calor, as Tiras de led devem ser coladas num perfil de alumínio. Parte traseira das Tiras de led com fita adesiva.  
Para manter uma emissão constante de luz a partir de um comprimento de 3 m, recomendamos alimentar as tiras nos dois lados.  
A partir de um comprimento de 5 m, deve-se fazer nova alimentação.

# FLEXSTRIPS

## VISÃO GERAL

### GRAZIA LED

1004708  
1004709  
1004710

70 LED/m

### GRAZIA PRO

1004712  
1004713  
1004714

126 LED/m

### GRAZIA PRO

1004716  
1004717  
1004718  
1004719

168 LED/m

### GRAZIA PRO MAX

1004720  
1004721

196 LED/m

### GRAZIA PRO MAX

1004722  
1004723

196 LED/m

500  
cm

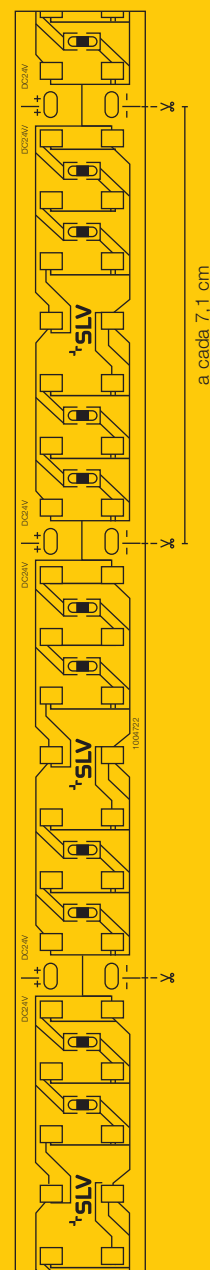
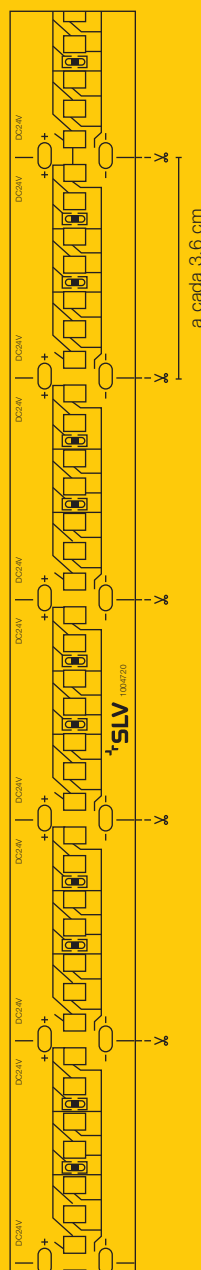
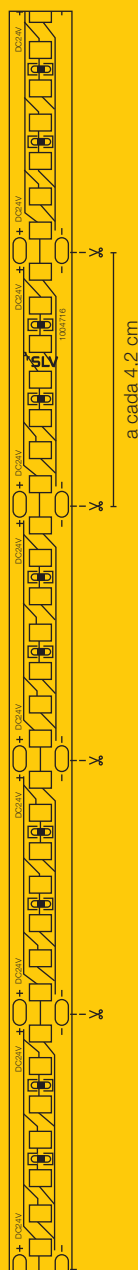
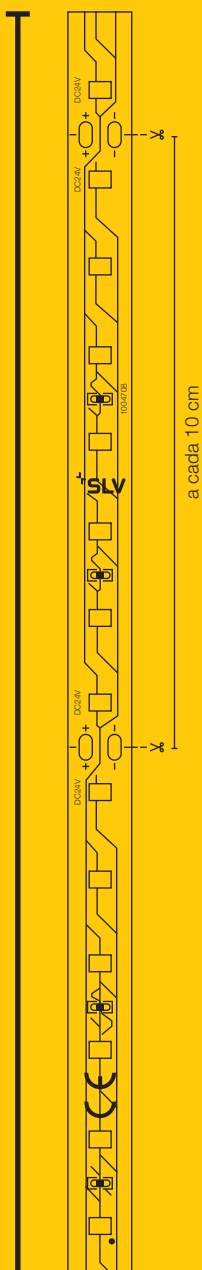





Todas as faixas flexíveis podem ser alimentadas nos dois lados

Todas as faixas LED GRAZIA têm por base 24V. Controladores e outros acessórios adequados podem ser encontrados na página 582.



IP54

**GRAZIA  
PRO MAX**  
*TUNABLE WHITE*

1004725

224 LED/m

**GRAZIA  
PRO MAX**  
*RGBW*

1004727

70 LED/m

**GRAZIA  
IP**

1004734  
1004735  
1004736

70 LED/m

**GRAZIA  
IP**  
*TUNABLE WHITE*

1004726

224 LED/m

**GRAZIA  
IP**  
*RGBW*

1004737

70 LED/m

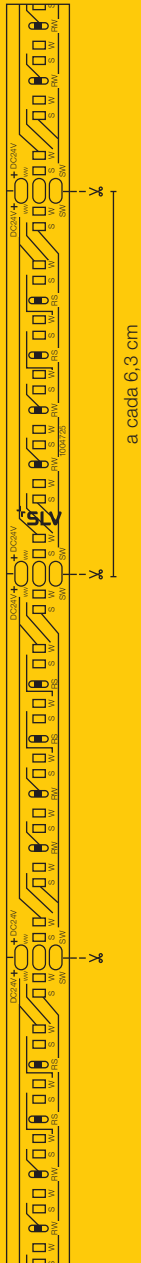

a cada 6,3 cm



a cada 10 cm

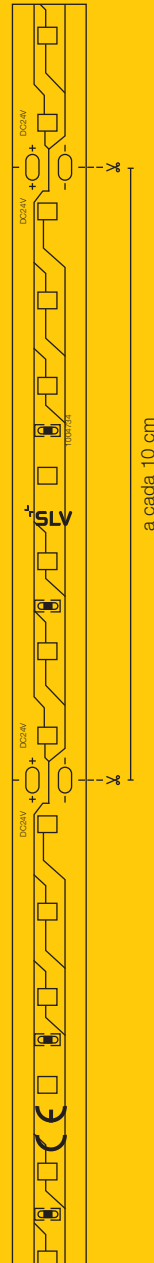

a cada 10 cm

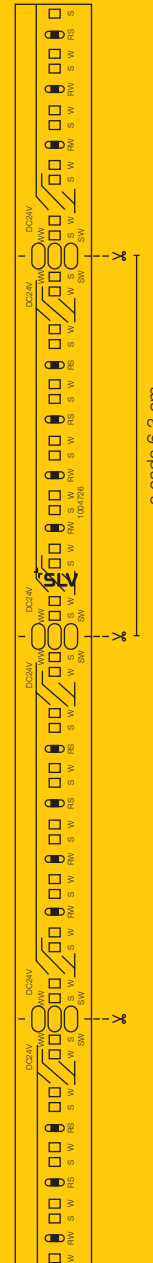

a cada 6,3 cm

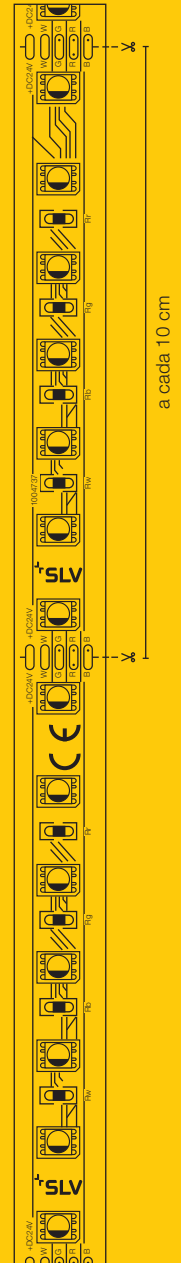

a cada 10 cm



NEW

LED  
VINOLINA ONE | 597



NEW

LED  
VINOLINA | 597



NEW

LED  
VINOLINA TWO | 599



LED  
TONILA | 601



NEW

LED  
TAHA | 601



NEW

SCKET  
S-TUBE 32/75 | 603



NEW

SCKET  
PHOTONI 45/75 | 605



NEW

LED  
S-CUBE 35/75 | 607



NEW

LED  
R-CUBE 35/70 | 609



NEW

LED  
LID I 75 | 611



NEW

LED  
LID I 45 | 611



NEW

LED  
I-RING | 613



NEW

LED  
M-POL S | 614



NEW

LED  
M-POL S | 615



LED  
M-POL S | 616



LED  
M-POL S | 617



LED  
M-POL S | 618



LED  
M-POL M | 619



LED  
M-POL M | 620



LED  
M-POL M | 621



M-POL 30/60/90 | 623



SCKET  
CONCRETO | 627



SCKET  
CONCRETO | 627



LED  
ESKINA  
FRAME 45/75 | 629



LED  
ESKINA  
FRAME 75 | 629



LED  
ESKINA  
FRAME  
125/175 | 630



LED  
ESKINA 30/80 | 631



LED  
LOGS 40/70 | 633



SCKET  
GRAFIT 30/60/90 | 635



SCKET  
GRAFIT 30/60/90 | 637



LED  
QUADRULO | 639



LED  
RUSTY®  
SLOT 50/80 | 640



SCKET  
RUSTY®  
SLOT 50/80 | 641



SCKET  
RUSTY®  
PATHLIGHT | 642



LED  
RUSTY® 40/70 | 643



SCKET  
RUSTY® 40/70 | 643



SCKET  
RUSTY®  
CONE 24 | 645



SCKET  
RUSTY®  
CONE 40/70 | 645



SCKET  
RUSTY® 40/70 | 646



SCKET  
ARROCK  
GRANITE 40/70 | 647



SCKET  
ARROCK  
ARC | 648



LED  
ARROCK  
STONE 50/75 | 649



**SCKET**  
ARROCK SLOT | 649



**LED**  
L-LINE OUT 30 | 650



**LED**  
L-LINE OUT 60 | 651



**LED**  
L-LINE OUT 50/80 | 651



**SCKET**  
THEO PATHLIGHT | 652



**LED**  
OVALISK 75/100 | 653



**SCKET**  
GLOO PURE  
27/44/70 | 655



**SCKET**  
ROTOBALL  
25/40/50 | 657



**SCKET**  
PHOTONIA | 659



**SCKET**  
PHOTONIA | 659



**SCKET**  
OTOS GLAS | 659



**SCKET**  
CUBIX | 660



**SCKET**  
CONE | 660



**SCKET**  
MOLAT | 661



**SCKET**  
MOLAT | 661



**SCKET**  
LISENNE 40/70 | 662



**SCKET**  
ADEGAN  
MANILA | 663



**SCKET**  
ADEGAN | 663



**SCKET**  
ALPA MUSHROOM  
45/75 | 665



**SCKET**  
ALPA CONE 100 | 665



**LED**  
APONI 90/120 | 666



**LED**  
TRUST 30/60 | 667



**SCKET**  
BIG NAILS 50/80 | 668



**SCKET**  
ROX ACRYL  
30/60/90 | 669



**SCKET**  
VAP SLIM  
30/60/90 | 671



**SCKET**  
C-POL | 672



**SCKET**  
F-POL | 672



**SCKET**  
SQUARE  
POLE 30/60/90 | 673



**LED**  
SLOTS 45/65 | 675



**LED**  
H-POL 30/60 | 676



**LED**  
H-POL TWIN  
30/60 | 677



**LED**  
SLOTBOX 40/70 | 678



**LED**  
FLATT 65/100 | 679



**LED**  
ABRIDOR 60/100 | 681



**LED**  
IPERI 50 | 681



**SCKET**  
QUADRASYL 75 | 682



**LED**  
QUAD POLE | 683



**LED**  
BOOKAT | 683



**LED**  
RASCALI 45/65 | 684



**SCKET**  
MYRA SPOT | 685



**SCKET**  
SITRA 360 | 685



1007357 597

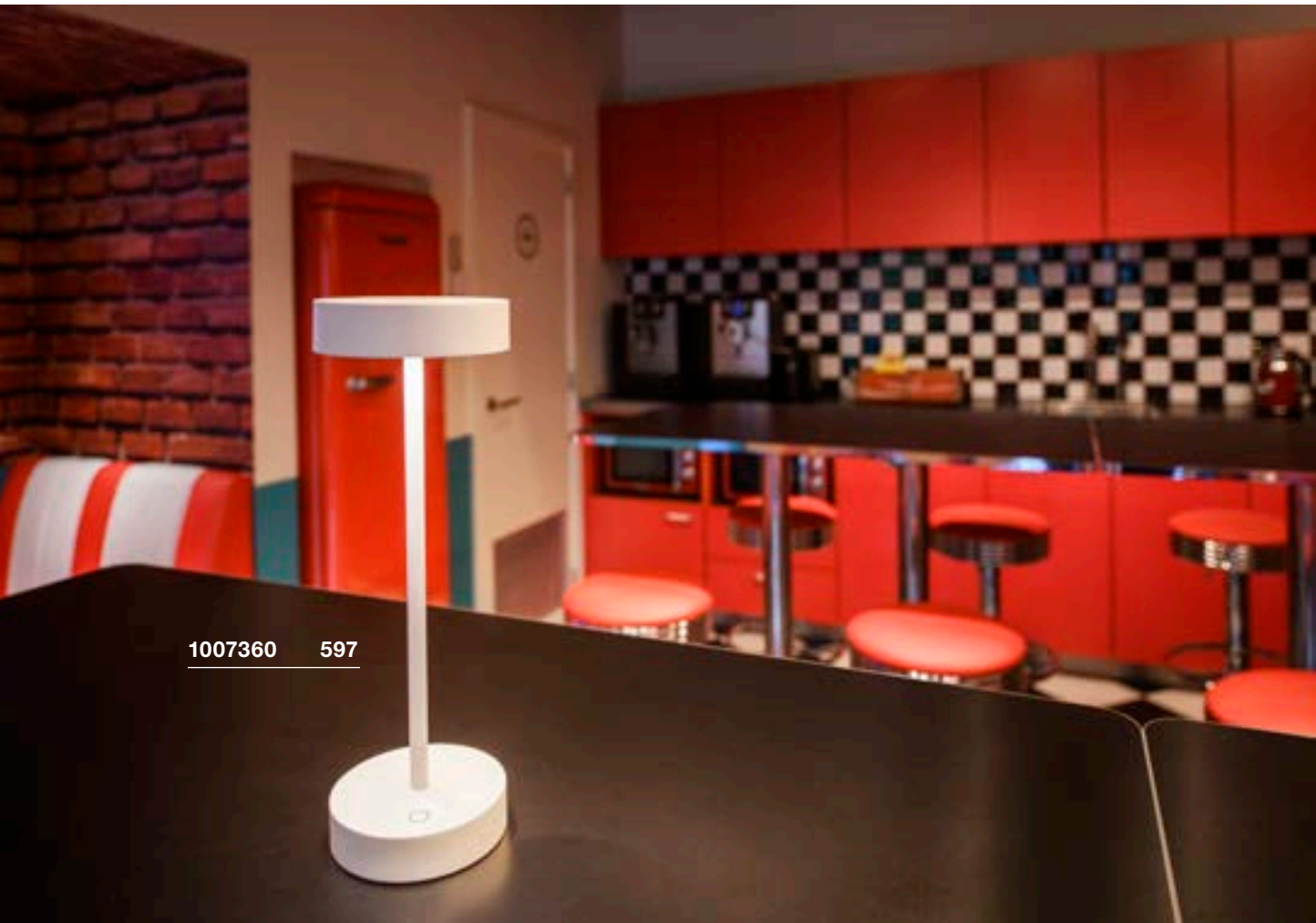

1007360 597



## VINOLINA ONE TL, Bateria

## VINOLINA TL, Bateria

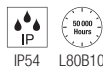
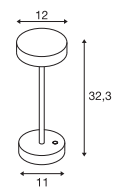
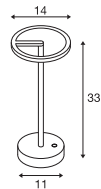
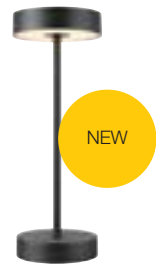

Funcionamento a bateria de 5V  
Potência total: 2,5W  
Material: alumínio

- Duração 12h
- Tempo de carregamento 7h
- Inclui placa de carregamento
- Não inclui fonte de alimentação
- USB A



Funcionamento a bateria de 5V  
Potência total: 2,2W  
Material: alumínio

- Duração 12h
- Tempo de carregamento 7h
- Inclui placa de carregamento
- Não inclui fonte de alimentação
- USB A



Down 125lm | 2700K



Down 130lm | 2700K | 130lm | 3000K

Variante	Art. n.º	EUR
● Preto	1007359	139,00
○ Branco	1007357	139,00
● Oxidado	1007358	139,00

Variante	Art. n.º	EUR
● Preto	1007362	139,00
○ Branco	1007360	139,00
● Oxidado	1007361	139,00



1007697 599



## VINOLINA TWO TL, Bateria

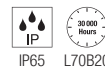
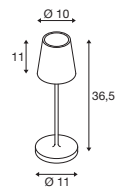

IP65 L70B20

Funcionamento a bateria de 5V  
Potência total: 2W  
Material: alumínio

- Touch regulável
- Duração 10h
- Tempo de carregamento 5h
- Inclui estação de carregamento para uma luminária



Down 190lm | 2200K  
2700K  
3000K

Variante	Art. n.º	EUR
● Preto	1007693	139,00
○ Branco	1007692	139,00
● Areia	1007697	139,00
● Oxidado	1007695	139,00
● Vermelho	1007694	139,00
● Verde-lima	1007696	139,00



1007380 601

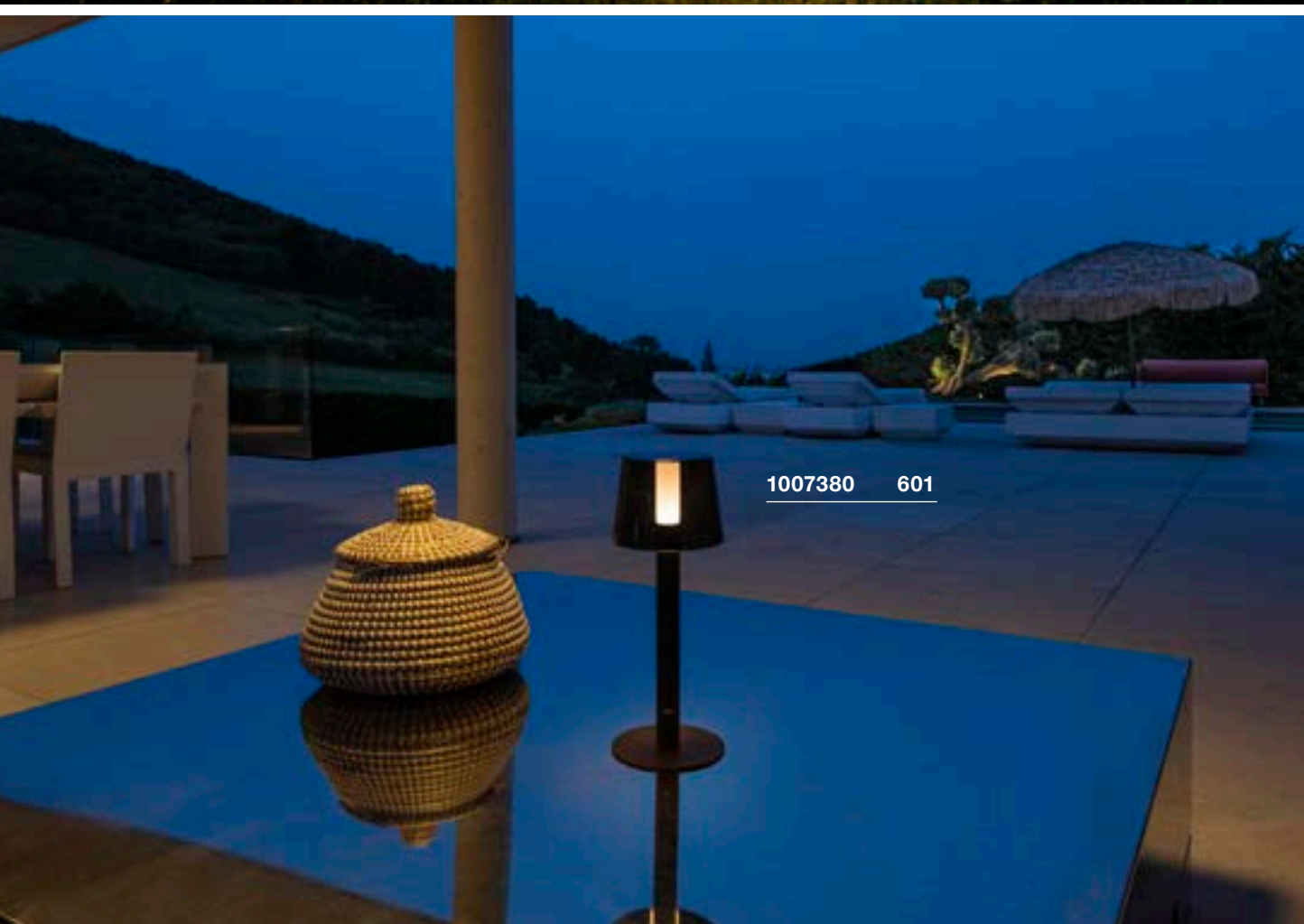

1007380 601





## TONILA TL

## TAHA Luminária, bateria

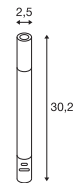
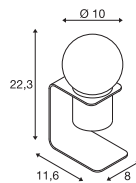

Funcionamento a bateria de 5V  
Potência total: 1,6W  
Material: alumínio/plástico

- Bateria de 3,6V 2000mAh incl.
- Sem fonte de alimentação, requer um carregador USB de 5V CC/1-2A.  
Para cabo de carregamento MINI USB
- Regulável com botão em 3 níveis



Down 90lm | 2700K

Variante	Art. n.º	EUR
● Preto	1002583	118,00

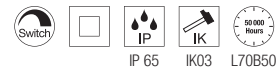

100-240V ~50/60Hz | Funcionamento a bateria de 5V  
Potência total: 5W  
Máx. Controlador com saída em U: 5V DC  
Material: alumínio/plástico

- Inclui cabo de carregamento



Down 200lm | 2700K

Variante	Art. n.º	EUR
● Preto	1007380	159,00
● Amarelo		

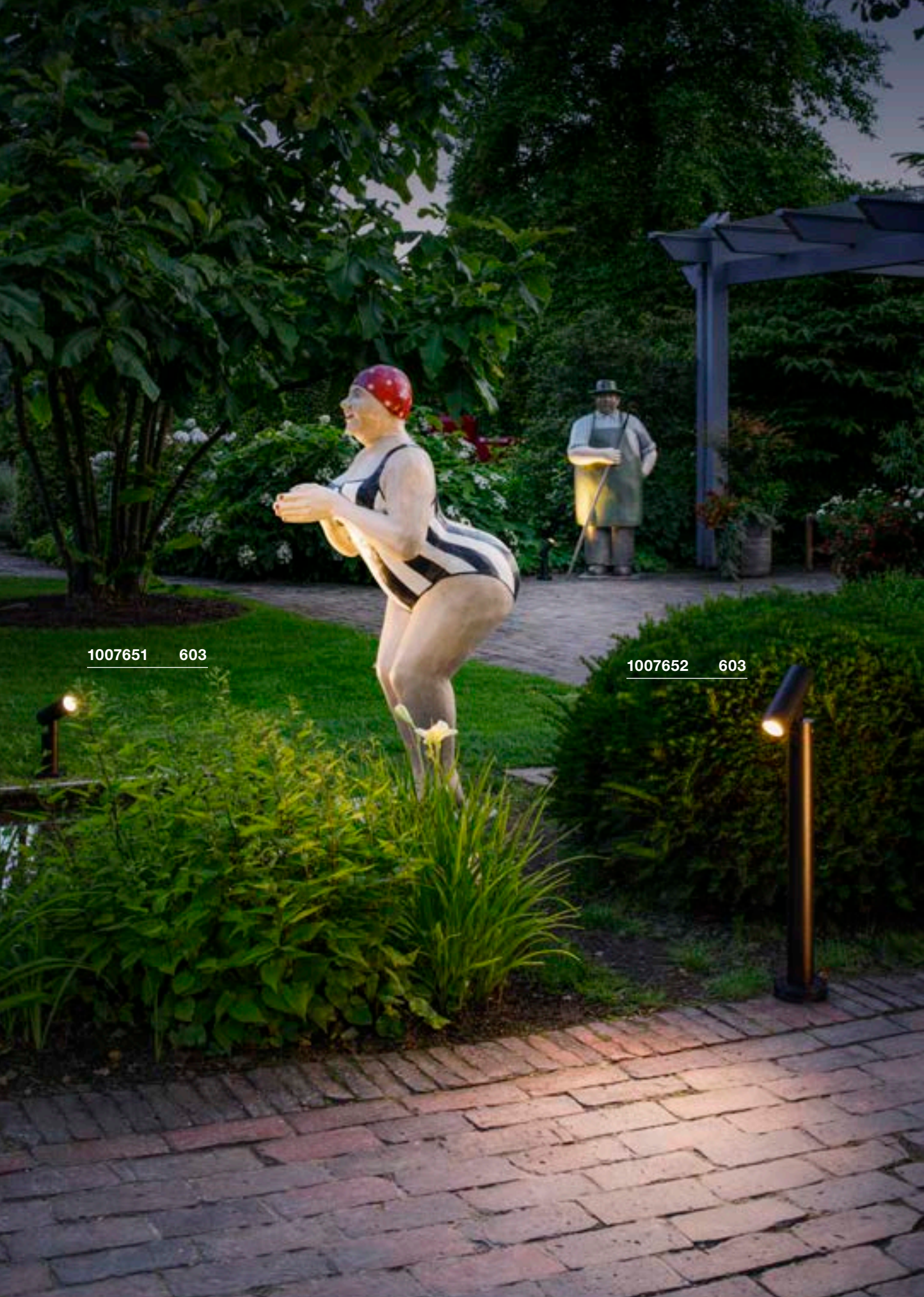

1007651 603

1007652 603



### S-TUBE 32 Pole, GU10

### S-TUBE 75 Pole, GU10

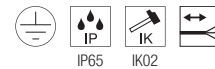
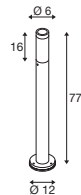
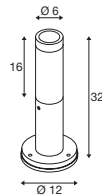

220-240V ~50/60Hz  
Material: alumínio

220-240V ~50/60Hz  
Material: alumínio

- Extremidade do cabo aberta

- Extremidade do cabo aberta



Casquilho: 1xGU10 Máx. Ø: 5 cm | C: 5,5 cm

Casquilho: 1xGU10 Máx. Ø: 5 cm | C: 5,5 cm

Variante	Art. n.º	EUR
● Preto	1007651	84,00

Variante	Art. n.º	EUR
● Preto	1007652	134,00



LED GU10 51mm | 6W | 38°  
2700K | 450lm | EE=F  
6kWh/1000h



Art. N.º: 1005077 | 7,50 EUR



LED GU10 51mm | 6W | 38°  
2700K | 450lm | EE=F  
6kWh/1000h



Art. N.º: 1005077 | 7,50 EUR



Artigo	Art. n.º	EUR
Caixa de ligação IP68, 3 polos		
● Preto	228730	23,00



Artigo	Art. n.º	EUR
Caixa de ligação IP68, 3 polos		
● Preto	228730	23,00



1007587 605

1007584 605



PHOTONI 45  
Pole, E27

PHOTONI 75  
Pole, E27

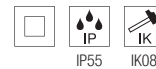
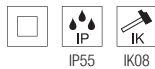
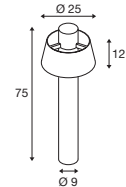
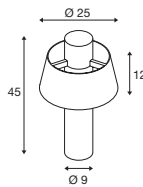

220-240V ~50/60Hz  
Material: alumínio

220-240V ~50/60Hz  
Material: alumínio

- Caixa de ligação IP
- Resistente à atmosfera marítima

- Caixa de ligação IP
- Resistente à atmosfera marítima



Casquilho: 1xE27 Máx. Ø: 6 cm | C: 11,6 cm

Casquilho: 1xE27 Máx. Ø: 6 cm | C: 11,6 cm

Variante	Art. n.º	EUR
● Preto	1007587	179,00
● Oxidado	1007583	179,00

Variante	Art. n.º	EUR
● Preto	1007584	199,00
● Oxidado	1007580	199,00



A60 | 7,5W | 180°  
2700K | 720lm | EE=F  
8kWh/1000h



Art. N.º: 1005305 | 19,00 EUR



A60 | 7,5W | 180°  
2700K | 720lm | EE=F  
8kWh/1000h



Art. N.º: 1005305 | 19,00 EUR

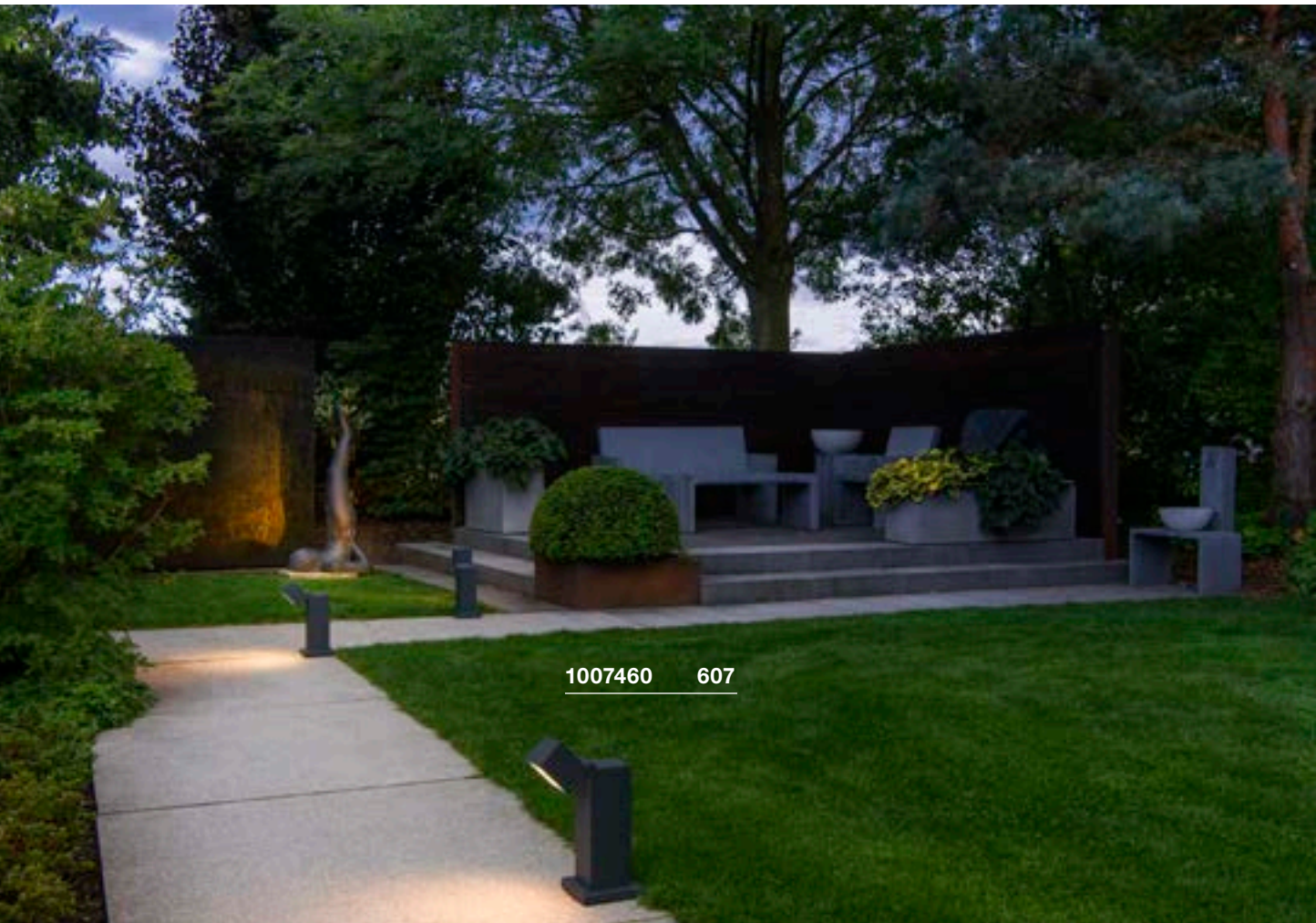



### S-CUBE 35 Pole

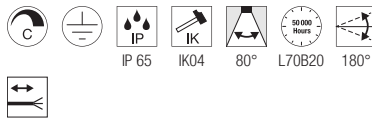
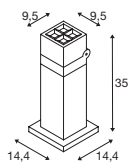

220-240V ~50/60Hz | 350mA  
Potência total: 15W  
Material: alumínio

- Extremidade do cabo aberta



Down 1000lm | 2700K | 1200lm | 3000K

Variante	Art. n.º	EUR
● Antracite	1007460	● 199,00



Artigo	Art. n.º	EUR
Caixa de ligação IP68, 3 polos		
● Preto	228730	23,00

### S-CUBE 75 Pole

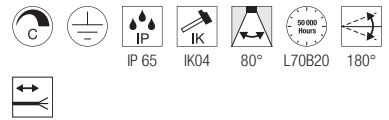
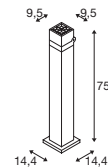

220-240V ~50/60Hz | 350mA  
Potência total: 15W  
Material: alumínio

- Extremidade do cabo aberta



Down 1000lm | 2700K | 1200lm | 3000K

Variante	Art. n.º	EUR
● Antracite	1007459	● 234,00



Artigo	Art. n.º	EUR
Caixa de ligação IP68, 3 polos		
● Preto	228730	23,00



1007513 609





### R-CUBE 35 Pole

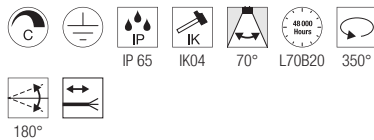
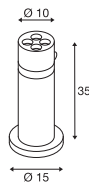
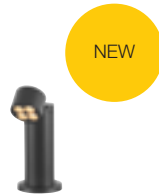

220-240V ~50/60Hz | 350mA  
Potência total: 15W  
Material: alumínio

- Extremidade do cabo aberta



Down 800lm | 2700K | 800lm | 3000K

Variante	Art. n.º	EUR
● Antracite	1007513	● 199,00



Artigo	Art. n.º	EUR
Caixa de ligação IP68, 3 polos		
● Preto	228730	23,00

### R-CUBE 75 Pole

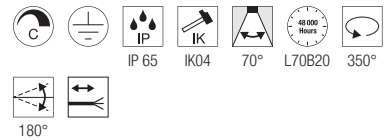
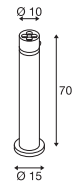

220-240V ~50/60Hz | 350mA  
Potência total: 15W  
Material: alumínio

- Extremidade do cabo aberta



Down 800lm | 2700K | 800lm | 3000K

Variante	Art. n.º	EUR
● Antracite	1007512	● 234,00



Artigo	Art. n.º	EUR
Caixa de ligação IP68, 3 polos		
● Preto	228730	23,00



1007670 611

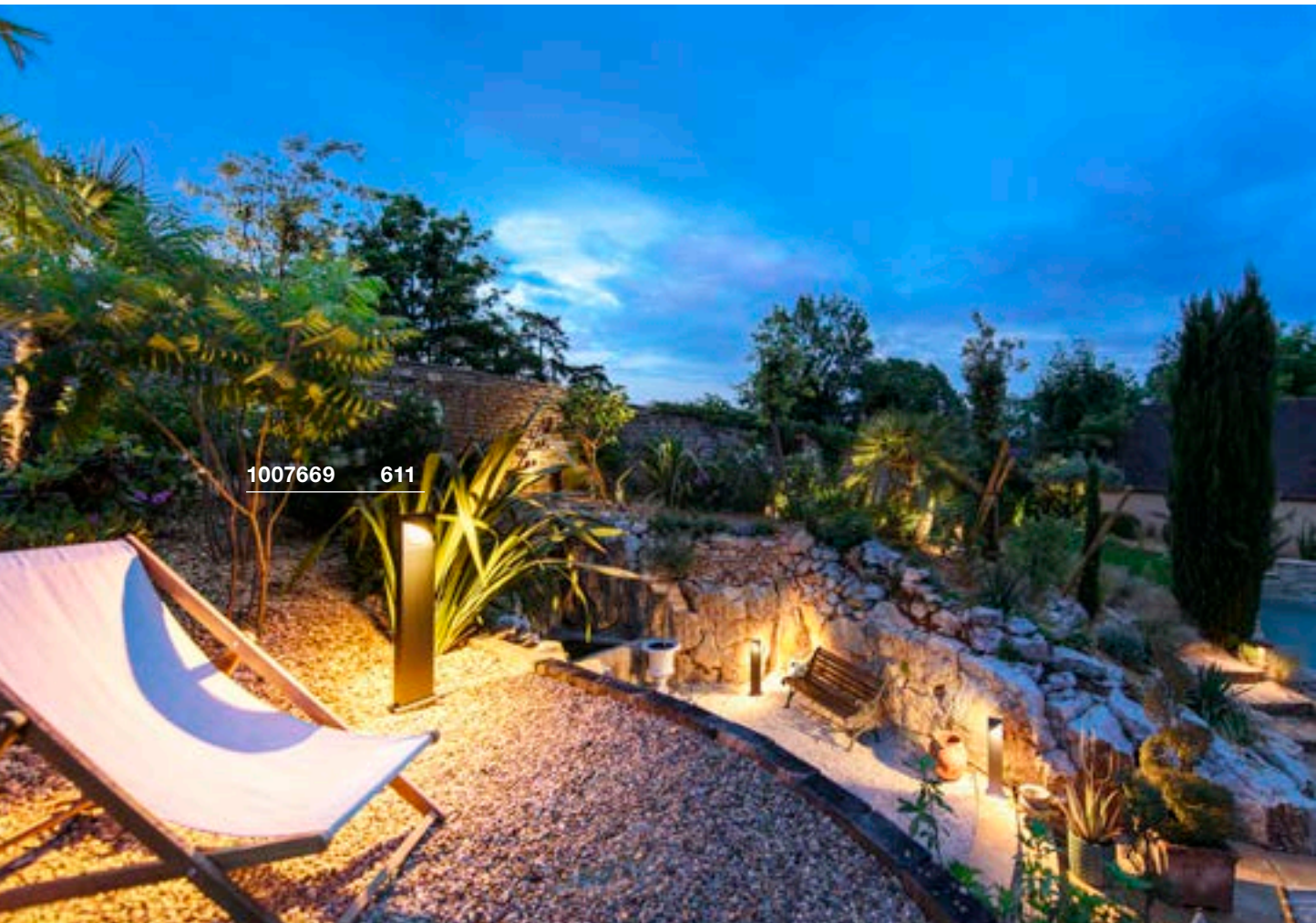

1007669 611



### LID I 75 Pole, double

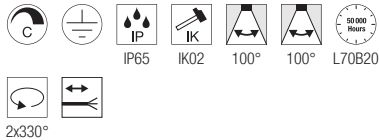
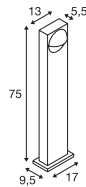

220-240V ~50/60Hz | 700mA  
Potência total: 29W  
Material: alumínio

- Extremidade do cabo aberta



Down 850lm | 2700K | 1000lm | 3000K

Variante	Art. n.º	EUR
● Antracite	1007669	● 299,00



Artigo	Art. n.º	EUR
Caixa de ligação IP68, 3 polos		
● Preto	228730	23,00

### LID I 45 Pole, single

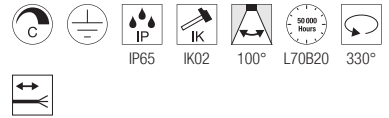
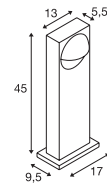

220-240V ~50/60Hz | 350mA  
Potência total: 15W  
Material: alumínio

- Extremidade do cabo aberta



Down 900lm | 2700K | 1050lm | 3000K

Variante	Art. n.º	EUR
● Antracite	1007670	● 219,00



Artigo	Art. n.º	EUR
Caixa de ligação IP68, 3 polos		
● Preto	228730	23,00



1007237 613



## I-RING Pole

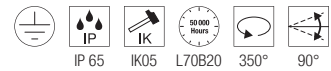
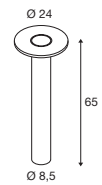

100-240V ~50/60Hz | 350mA  
 Potência total: 9,2W  
 Material: alumínio



Down

670lm | 3000K

Variante	Art. n.º	EUR
● Antracite	1007237	● 229,00



Artigo	Art. n.º	EUR
Jogo de parafusos		
● Aço inoxidável	228753	9,25

M-POL S  
Polehead 360°, Sem encandeamento

M-POL S  
Polehead 360°, Sem encandeamento, DALI

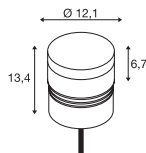
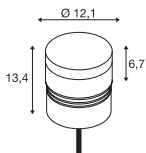

220-240V ~50/60Hz | 500mA  
Potência total: 10W  
Material: alumínio

220-240V ~50/60Hz | 500mA  
Potência total: 10W  
Material: alumínio



Down 750lm | 2700K



Down 750lm | 2700K

Variante	Art. n.º	EUR
● Antracite	1007232	290,00

Variante	Art. n.º	EUR
● Antracite	1007233	310,00



Artigo	Art. n.º	EUR
Poste		
● Antracite		
A: 23,4 cm	1006379	99,00
● Antracite		
A: 53,4 cm	1006380	139,00
● Antracite		
A: 83,4 cm	1006381	169,00
Âncora de chão		
● Aço inoxidável	1006382	49,00
Caixa de conector em T		
● Preto	228726	36,00
Caixa de ligação IP68, 3 polos		
● Preto	228730	23,00



Artigo	Art. n.º	EUR
Poste		
● Antracite		
A: 23,4 cm	1006379	99,00
● Antracite		
A: 53,4 cm	1006380	139,00
● Antracite		
A: 83,4 cm	1006381	169,00
Âncora de chão		
● Aço inoxidável	1006382	49,00
Caixa de ligação		
● Preto	228725	17,90
Caixa de ligação IP68, 5 polos		
● Preto	1006453	35,00

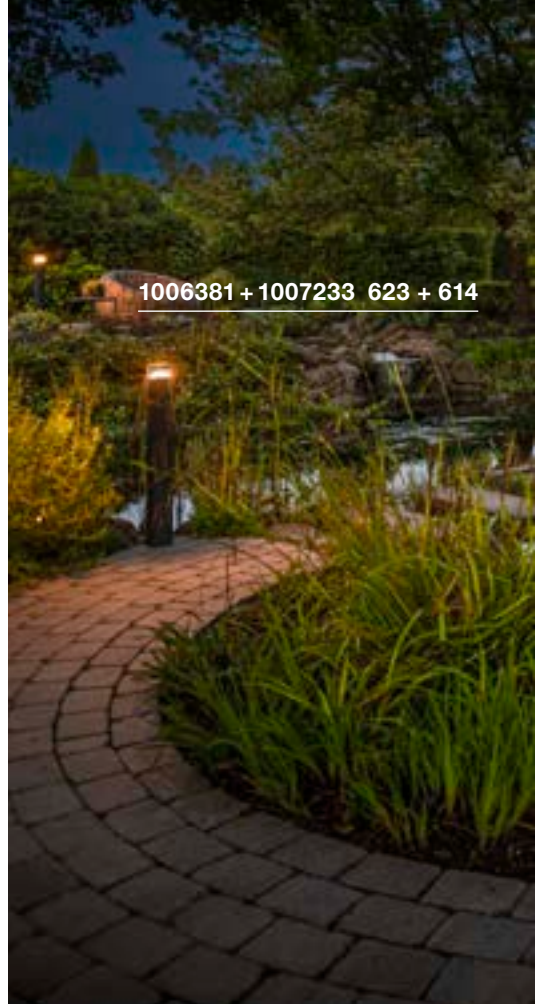



M-POL S  
Polehead 180°, Sem encandeamento

M-POL S  
Polehead 180°, Sem encandeamento, DALI

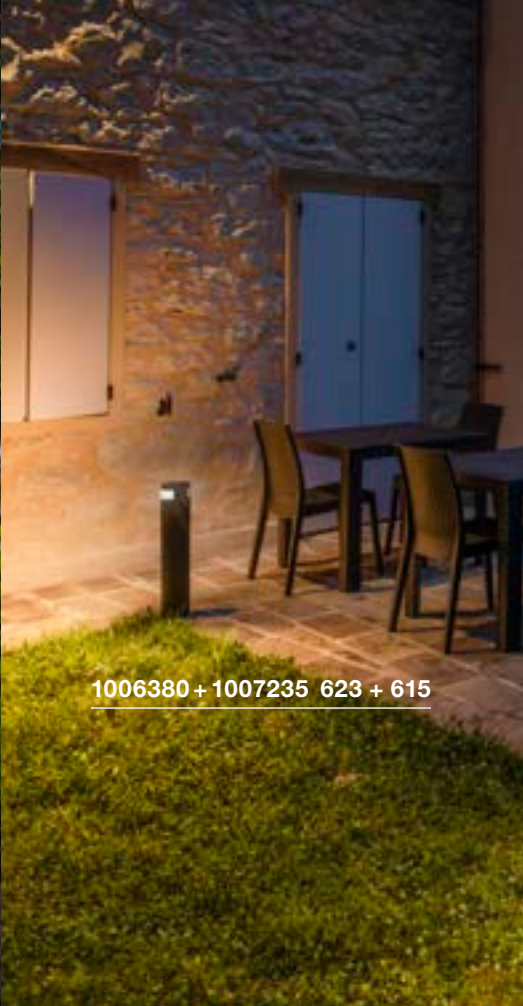

1006380 + 1007235 623 + 615

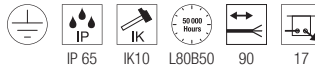
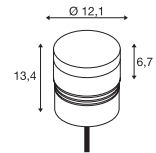
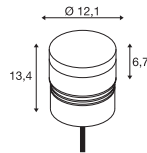

220-240V ~50/60Hz | 500mA  
Potência total: 10W  
Material: alumínio



220-240V ~50/60Hz | 500mA  
Potência total: 10W  
Material: alumínio



Down 700lm | 2700K



Down 700lm | 2700K

Variante	Art. n.º	EUR
● Antracite	1007234	299,00

Variante	Art. n.º	EUR
● Antracite	1007235	319,00



Artigo	Art. n.º	EUR
Poste		
● Antracite		
A: 23,4 cm	1006379	99,00
● Antracite		
A: 53,4 cm	1006380	139,00
● Antracite		
A: 83,4 cm	1006381	169,00
Âncora de chão		
● Aço inoxidável	1006382	49,00
Caixa de conector em T		
● Preto	228726	36,00
Caixa de ligação IP68, 3 polos		
● Preto	228730	23,00



Artigo	Art. n.º	EUR
Poste		
● Antracite		
A: 23,4 cm	1006379	99,00
● Antracite		
A: 53,4 cm	1006380	139,00
● Antracite		
A: 83,4 cm	1006381	169,00
Âncora de chão		
● Aço inoxidável	1006382	49,00
Caixa de ligação		
● Preto	228725	17,90
Caixa de ligação IP68, 5 polos		
● Preto	1006453	35,00





1006381 + 1006389 623 + 617

## M-POL S Polehead

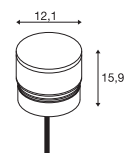

1006381 + 1006393 623 + 617

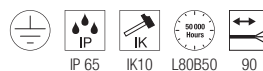

220-240V ~50/60Hz | 500mA  
Consumo de energia: 9W  
Potência total: 11W  
Material: alumínio



Down 470lm | 2700K | 510lm | 3000K

Variante	Art. n.º	EUR
● Antracite	1006383	259,00



Artigo	Art. n.º	EUR
Poste		
● Antracite A: 23,4 cm	1006379	99,00
● Antracite A: 53,4 cm	1006380	139,00
● Antracite A: 83,4 cm	1006381	169,00
Âncora de chão		
● Aço inoxidável	1006382	49,00
Caixa de conector em T		
● Preto	228726	36,00
Caixa de ligação IP68, 3 polos		
● Preto	228730	23,00





M-POL S  
Polehead, DALI

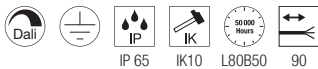
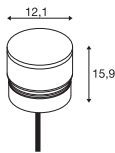

220-240V ~50/60Hz | 500mA  
Consumo de energia: 17W  
Potência total: 19W  
Material: alumínio



Down 890lm | 2700K | 950lm | 3000K

Variante	Art. n.º	EUR
● Antracite	1006389	365,00



Artigo	Art. n.º	EUR
Poste		
● Antracite		
A: 23,4 cm	1006379	99,00
● Antracite		
A: 53,4 cm	1006380	139,00
● Antracite		
A: 83,4 cm	1006381	169,00
Âncora de chão		
● Aço inoxidável	1006382	49,00
Caixa de ligação		
● Preto	228725	17,90
Caixa de ligação IP68, 5 polos		
● Preto	1006453	35,00

M-POL S  
Polehead, Shader

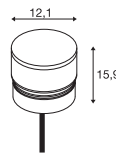

220-240V ~50/60Hz | 500mA  
Consumo de energia: 9W  
Potência total: 11W  
Material: alumínio



Down 285lm | 2700K | 310lm | 3000K

Variante	Art. n.º	EUR
● Antracite	1006387	279,00



Artigo	Art. n.º	EUR
Poste		
● Antracite		
A: 23,4 cm	1006379	99,00
● Antracite		
A: 53,4 cm	1006380	139,00
● Antracite		
A: 83,4 cm	1006381	169,00
Âncora de chão		
● Aço inoxidável	1006382	49,00
Caixa de conector em T		
● Preto	228726	36,00
Caixa de ligação IP68, 3 polos		
● Preto	228730	23,00

M-POL S  
Polehead, Shader, DALI

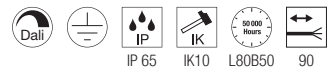
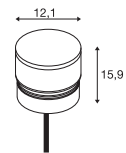

220-240V ~50/60Hz | 500mA  
Consumo de energia: 17W  
Potência total: 19W  
Material: alumínio



Down 520lm | 2700K | 550lm | 3000K

Variante	Art. n.º	EUR
● Antracite	1006393	385,00



Artigo	Art. n.º	EUR
Poste		
● Antracite		
A: 23,4 cm	1006379	99,00
● Antracite		
A: 53,4 cm	1006380	139,00
● Antracite		
A: 83,4 cm	1006381	169,00
Âncora de chão		
● Aço inoxidável	1006382	49,00
Caixa de ligação		
● Preto	228725	17,90
Caixa de ligação IP68, 5 polos		
● Preto	1006453	35,00

M-POL S  
Polehead, Louver

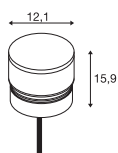

220-240V ~50/60Hz | 500mA  
Consumo de energia: 9W  
Potência total: 11W  
Material: alumínio



Down 145lm | 2700K 155lm | 3000K

Variante	Art. n.º	EUR
● Antracite	1006385	315,00



Artigo	Art. n.º	EUR
Poste		
● Antracite		
A: 23,4 cm	1006379	99,00
● Antracite		
A: 53,4 cm	1006380	139,00
● Antracite		
A: 83,4 cm	1006381	169,00
Âncora de chão		
● Aço inoxidável	1006382	49,00
Caixa de conector em T		
● Preto	228726	36,00
Caixa de ligação IP68, 3 polos		
● Preto	228730	23,00

M-POL S  
Polehead, Louver, DALI

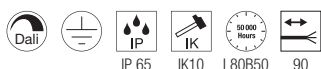
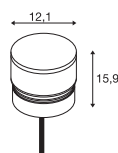

220-240V ~50/60Hz | 500mA  
Consumo de energia: 17W  
Potência total: 19W  
Material: alumínio



Down 260lm | 2700K 270lm | 3000K

Variante	Art. n.º	EUR
● Antracite	1006391	449,00



Artigo	Art. n.º	EUR
Poste		
● Antracite		
A: 23,4 cm	1006379	99,00
● Antracite		
A: 53,4 cm	1006380	139,00
● Antracite		
A: 83,4 cm	1006381	169,00
Âncora de chão		
● Aço inoxidável	1006382	49,00
Caixa de ligação		
● Preto	228725	17,90
Caixa de ligação IP68, 5 polos		
● Preto	1006453	35,00



1006381 + 1006391 623 + 618



1006381 + 1006388 623 + 619



### M-POL M Polehead

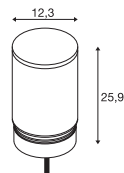

220-240V ~50/60Hz | 500mA  
Consumo de energia: 9W  
Potência total: 11W  
Material: alumínio



Down 590lm | 2700K | 660lm | 3000K

Variante	Art. n.º	EUR
● Antracite	1006384	279,00



Artigo	Art. n.º	EUR
Poste		
● Antracite		
A: 23,4 cm	1006379	99,00
● Antracite		
A: 53,4 cm	1006380	139,00
● Antracite		
A: 83,4 cm	1006381	169,00
Âncora de chão		
● Aço inoxidável	1006382	49,00
Caixa de conector em T		
● Preto	228726	36,00
Caixa de ligação IP68, 3 polos		
● Preto	228730	23,00

### M-POL M Polehead, DALI

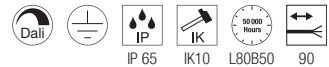
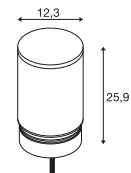

220-240V ~50/60Hz | 500mA  
Consumo de energia: 17W  
Potência total: 19W  
Material: alumínio



Down 1150lm | 2700K | 1230lm | 3000K

Variante	Art. n.º	EUR
● Antracite	1006390	385,00



Artigo	Art. n.º	EUR
Poste		
● Antracite		
A: 23,4 cm	1006379	99,00
● Antracite		
A: 53,4 cm	1006380	139,00
● Antracite		
A: 83,4 cm	1006381	169,00
Âncora de chão		
● Aço inoxidável	1006382	49,00
Caixa de ligação		
● Preto	228725	17,90
Caixa de ligação IP68, 5 polos		
● Preto	1006453	35,00

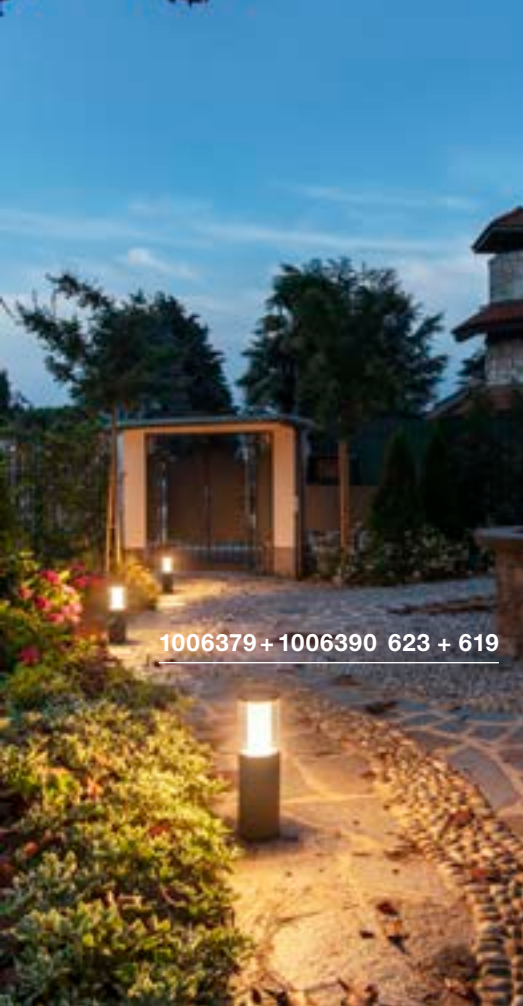

1006379 + 1006390 623 + 619



1006379 + 1006384 623 + 619



## M-POL M Polehead, Shader

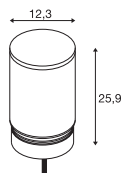

220-240V ~50/60Hz | 500mA  
Consumo de energia: 9W  
Potência total: 11W  
Material: alumínio



Down 420lm | 2700K | 460lm | 3000K

Variante	Art. n.º	EUR
● Antracite	1006388	299,00



Artigo	Art. n.º	EUR
Poste		
● Antracite		
A: 23,4 cm	1006379	99,00
● Antracite		
A: 53,4 cm	1006380	139,00
● Antracite		
A: 83,4 cm	1006381	169,00
Âncora de chão		
● Aço inoxidável	1006382	49,00
Caixa de conector em T		
● Preto	228726	36,00
Caixa de ligação IP68, 3 polos		
● Preto	228730	23,00

## M-POL M Polehead, Shader, DALI

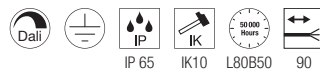
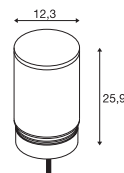

220-240V ~50/60Hz | 500mA  
Consumo de energia: 17W  
Potência total: 19W  
Material: alumínio



Down 820lm | 2700K | 870lm | 3000K

Variante	Art. n.º	EUR
● Antracite	1006394	409,00



Artigo	Art. n.º	EUR
Poste		
● Antracite		
A: 23,4 cm	1006379	99,00
● Antracite		
A: 53,4 cm	1006380	139,00
● Antracite		
A: 83,4 cm	1006381	169,00
Âncora de chão		
● Aço inoxidável	1006382	49,00
Caixa de ligação		
● Preto	228725	17,90
Caixa de ligação IP68, 5 polos		
● Preto	1006453	35,00

1006381 + 1006388 623 + 620



M-POL M  
Polehead, Louver

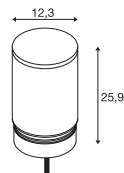

220-240V ~50/60Hz | 500mA  
Consumo de energia: 9W  
Potência total: 11W  
Material: alumínio



Down 190lm | 2700K | 210lm | 3000K

Variante	Art. n.º	EUR
● Antracite	1006386	439,00



Artigo	Art. n.º	EUR
Poste		
● Antracite		
A: 23,4 cm	1006379	99,00
● Antracite		
A: 53,4 cm	1006380	139,00
● Antracite		
A: 83,4 cm	1006381	169,00
Âncora de chão		
● Aço inoxidável	1006382	49,00
Caixa de conector em T		
● Preto	228726	36,00
Caixa de ligação IP68, 3 polos		
● Preto	228730	23,00

M-POL M  
Polehead, Louver, DALI

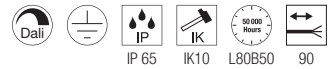
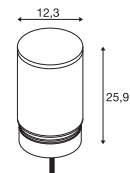

220-240V ~50/60Hz | 500mA  
Consumo de energia: 17W  
Potência total: 19W  
Material: alumínio



Down 350lm | 2700K | 370lm | 3000K

Variante	Art. n.º	EUR
● Antracite	1006392	529,00



Artigo	Art. n.º	EUR
Poste		
● Antracite		
A: 23,4 cm	1006379	99,00
● Antracite		
A: 53,4 cm	1006380	139,00
● Antracite		
A: 83,4 cm	1006381	169,00
Âncora de chão		
● Aço inoxidável	1006382	49,00
Caixa de ligação		
● Preto	228725	17,90
Caixa de ligação IP68, 5 polos		
● Preto	1006453	35,00

1006381 + 1006392 623 + 621



[1006380](tel:1006380) + [1006392](tel:1006392) - [623](tel:623) + [621](tel:621)



## M-POL 30 Pole



## M-POL 60 Pole



## M-POL 90 Pole



Material: alumínio

Variante	Art. n.º	EUR
● Antracite	1006379	99,00

Material: alumínio

Variante	Art. n.º	EUR
● Antracite	1006380	139,00

Material: alumínio

Variante	Art. n.º	EUR
● Antracite	1006381	169,00



Artigo	Art. n.º	EUR
Caixa de ligação IP68, 5 polos		
● Preto	1006453	35,00
Caixa de conector em T		
● Preto	228726	36,00
Caixa de ligação IP68, 3 polos		
● Preto	228730	23,00



Artigo	Art. n.º	EUR
Caixa de ligação IP68, 5 polos		
● Preto	1006453	35,00
Caixa de conector em T		
● Preto	228726	36,00
Caixa de ligação IP68, 3 polos		
● Preto	228730	23,00



Artigo	Art. n.º	EUR
Caixa de ligação IP68, 5 polos		
● Preto	1006453	35,00
Caixa de conector em T		
● Preto	228726	36,00
Caixa de ligação IP68, 3 polos		
● Preto	228730	23,00

# CRIE O SEU SISTEMA M-POL

---

Em poucos passos, consegue o balizador de jardim ideal – graças ao sistema M-POL modular. Para tal, combina-se três tamanhos e oito cabeças da luminária com cinco propriedades da luz e duas temperaturas de cor. Poderá escolher o formato alto ou baixo, com bloquador de luz para um efeito de luz esbatida num lado, uma radiação homogénea e difusa ou sem brilho através de grelhas integradas, ou ainda selecionado a temperatura de cor de 2700K ou 3000 Kelvin. Poderá controlar apenas em ON/OFF ou através de protocolo DALI. Configure aos seus balizadores M-POL pretendidos e destaque qualquer ambiente exterior com a melhor luz.

## SELECIONE O(S) SEU(S) ...

- 1 pilaretes (30, 60, 90) favoritos
- 2 Cabeça da luminária (On/Off, DALI)
- 3 Dimensão da cabeça da luminária (alta, plana)
- 4 Propriedade da luz (Clear, Shader, Louver)
- 5 Temperatura de cor (2700, 3000K)



JÁ ESTÁ!



# CABEÇAS DE LUMINÁRIA

## M-POL S

Ø: 12,3 cm, A: 15,9 cm

## M-POL M

Ø: 12,3 cm, A: 25,9 cm

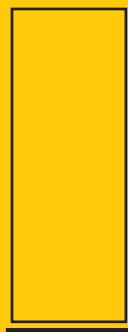
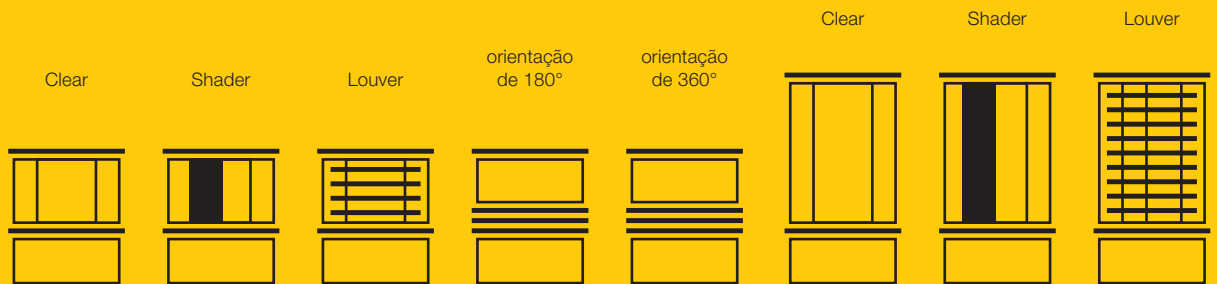

### M-POL 30

Ø: 12,4 cm, A: 23,4 cm

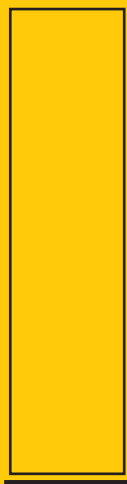

### M-POL 60

Ø: 12,4 cm, A: 53,4 cm

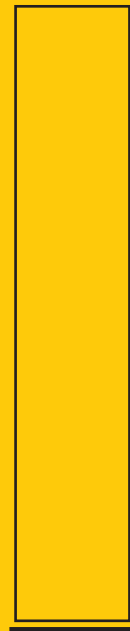

### M-POL 90

Ø: 12,4 cm, A: 83,4 cm

# BALIZADORES



1006408 627



**CONCRETO**  
FL, Redondo, QPAR 51

**CONCRETO**  
FL, Quadrado, QPAR51

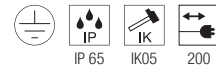
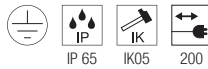
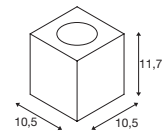
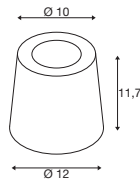

220-240V ~50/60Hz  
Material: betão/alumínio

220-240V ~50/60Hz  
Material: betão/alumínio

- Ficha IP44

- Ficha de contorno IP44



Casquilho: 1xGU10 Máx. Ø: 5,1 cm C: 6 cm

Casquilho: 1xGU10 Máx. Ø: 5,1 cm C: 6 cm

Variante	Art. n.º	EUR
● Cinzento	1006408	120,00

Variante	Art. n.º	EUR
● Cinzento	1006409	120,00



LED GU10 51mm | 6W | 38°  
2700K | 450lm | EE=F  
6kWh/1000h



Art. N.º: 1005077 | 7,50 EUR



LED GU10 51mm | 6W | 38°  
2700K | 450lm | EE=F  
6kWh/1000h



Art. N.º: 1005077 | 7,50 EUR



1004749 629

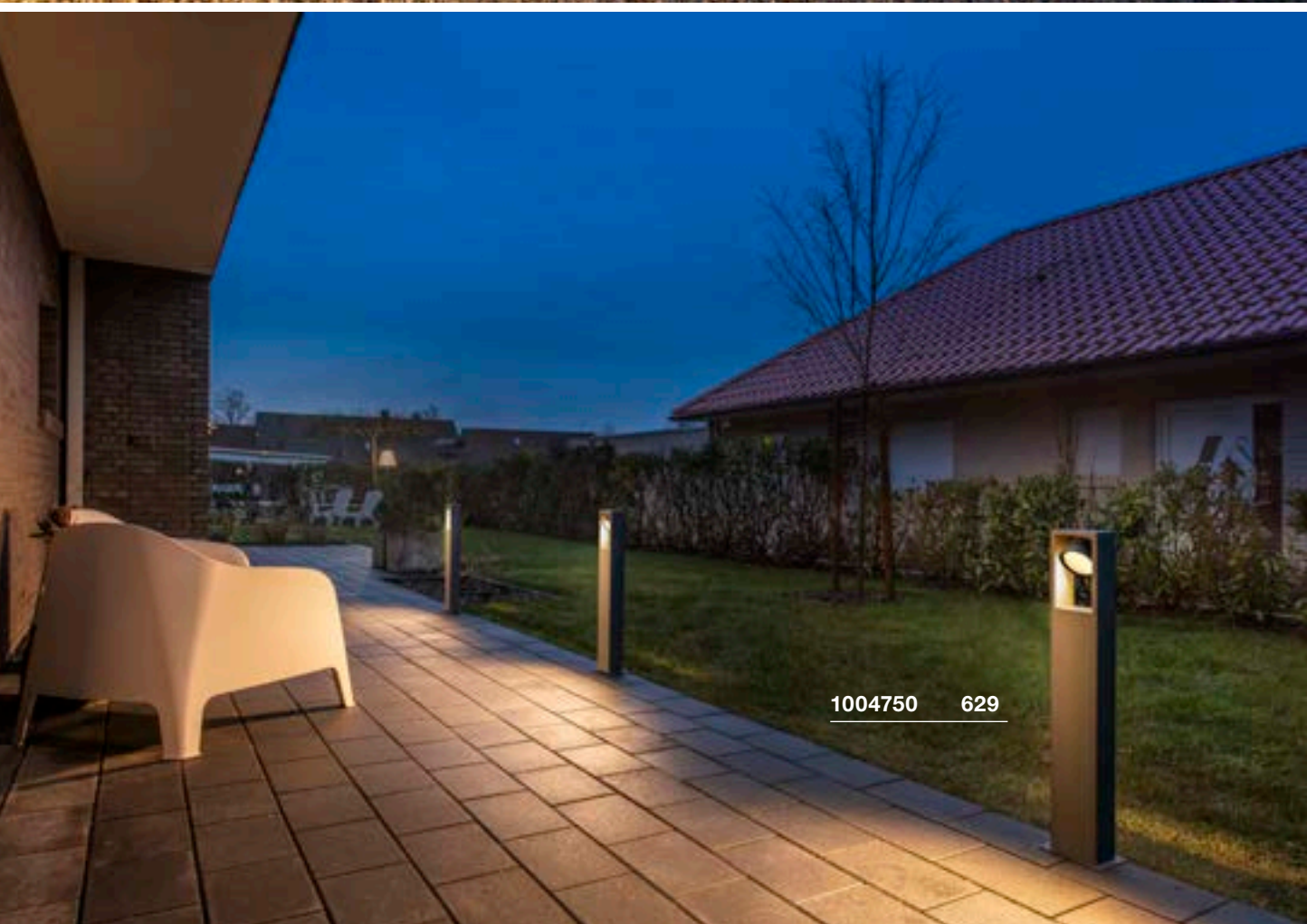

1004750 629



### ESKINA FRAME 45 Pole, single

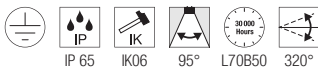
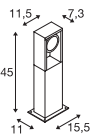

220-240V ~50/60Hz | 350mA  
Potência total: 15W  
Material: alumínio



Down 1100lm | 3000K | 1200lm | 4000K

Variante	Art. n.º	EUR
● Antracite	1004749	282,00



Artigo	Art. n.º	EUR
Caixa de ligação IP68, 3 polos		
● Preto	228730	23,00

### ESKINA FRAME 75 Pole, single

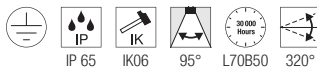
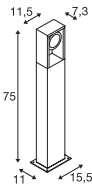

220-240V ~50/60Hz | 350mA  
Potência total: 15W  
Material: alumínio



Down 1100lm | 3000K | 1200lm | 4000K

Variante	Art. n.º	EUR
● Antracite	1004750	308,00



Artigo	Art. n.º	EUR
Caixa de ligação IP68, 3 polos		
● Preto	228730	23,00

### ESKINA FRAME 75 Pole, double

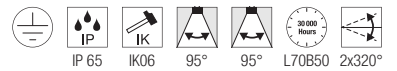
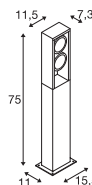

220-240V ~50/60Hz | 700mA  
Potência total: 27W  
Material: alumínio



Spot 1 1100lm | 3000K | 1200lm | 4000K  
Spot 2 1100lm | 3000K | 1200lm | 4000K

Variante	Art. n.º	EUR
● Antracite	1004751	349,00



Artigo	Art. n.º	EUR
Caixa de ligação IP68, 3 polos		
● Preto	228730	23,00

## ESKINA FRAME 125

Pole, double

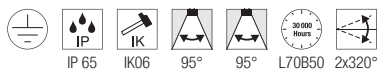
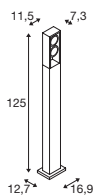

220-240V ~50/60Hz | 700mA  
Potência total: 27W  
Material: alumínio



Spot 1	1100lm	3000K	1200lm	4000K
Spot 2	1100lm	3000K	1200lm	4000K

Variante	Art. n.º	EUR
● Antracite	1005439	403,00



Artigo	Art. n.º	EUR
Caixa de ligação IP68, 3 polos		
● Preto	228730	23,00

## ESKINA FRAME 175

Pole, double

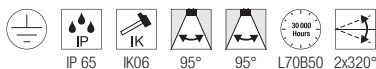
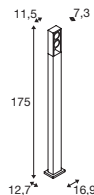

220-240V ~50/60Hz | 700mA  
Potência total: 27W  
Material: alumínio



Spot 1	1100lm	3000K	1200lm	4000K
Spot 2	1100lm	3000K	1200lm	4000K

Variante	Art. n.º	EUR
● Antracite	1005440	474,00



Artigo	Art. n.º	EUR
Caixa de ligação IP68, 3 polos		
● Preto	228730	23,00

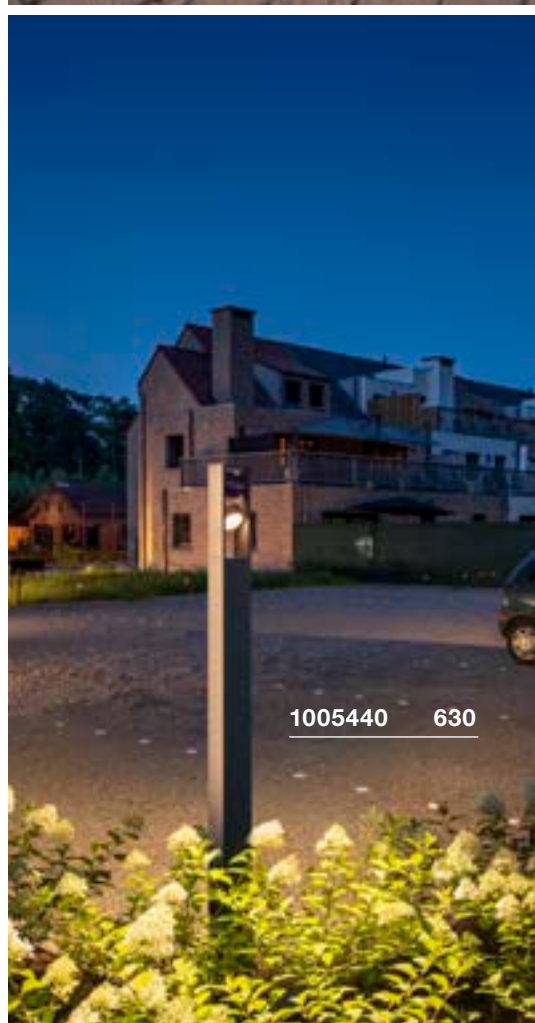
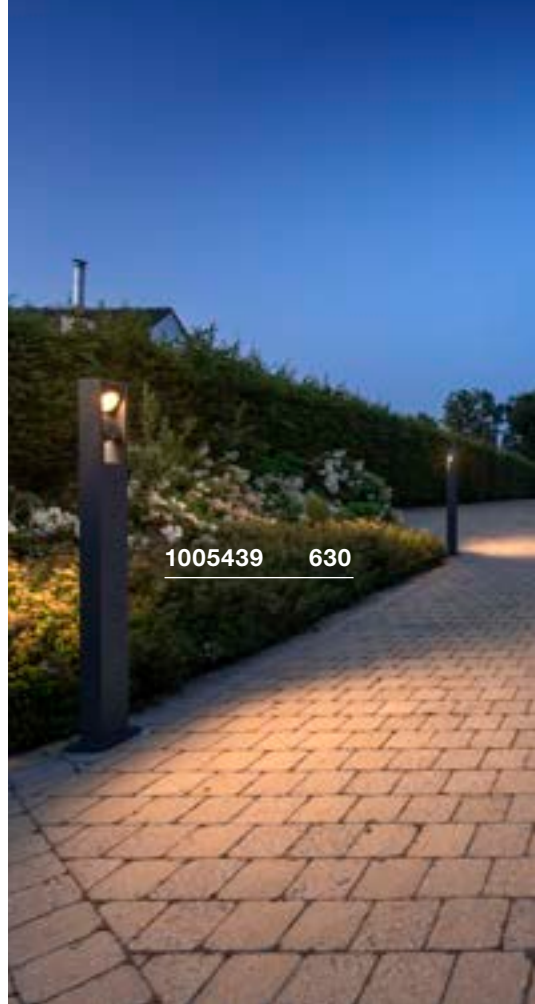

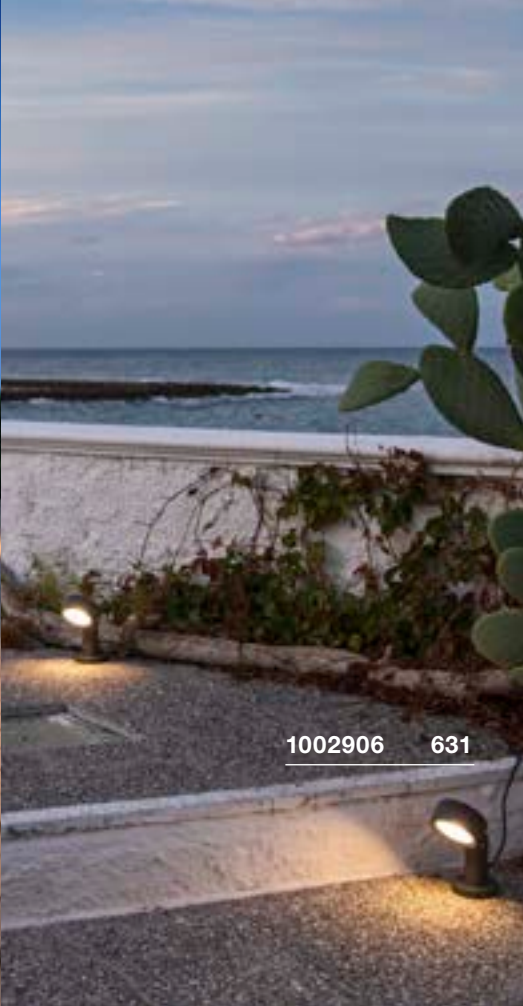

1002906 631



1002907 631

### ESKINA 30 Pole

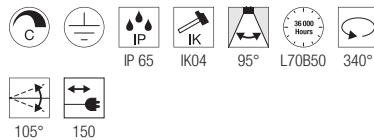
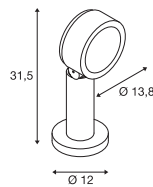

220-240V ~50/60Hz | 350mA  
Potência total: 14,5W  
Material: alumínio

- Ficha IP44



Down 1000lm | 3000K | 4000K

Variante	Art. n.º	EUR
● Antracite	1002906	282,00



Artigo	Art. n.º	EUR
Estaca		
● Cinzento	230060	53,00

### ESKINA 80 Pole

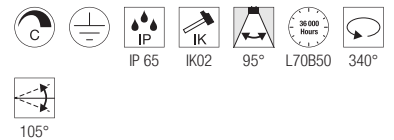
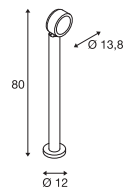

220-240V ~50/60Hz | 350mA  
Potência total: 14,5W  
Material: alumínio



Down 1000lm | 3000K | 4000K

Variante	Art. n.º	EUR
● Antracite	1002907	308,00



Artigo	Art. n.º	EUR
Estaca		
● Cinzento	230060	53,00
Caixa de ligação IP68, 3 polos		
● Preto	228730	23,00



232115

633

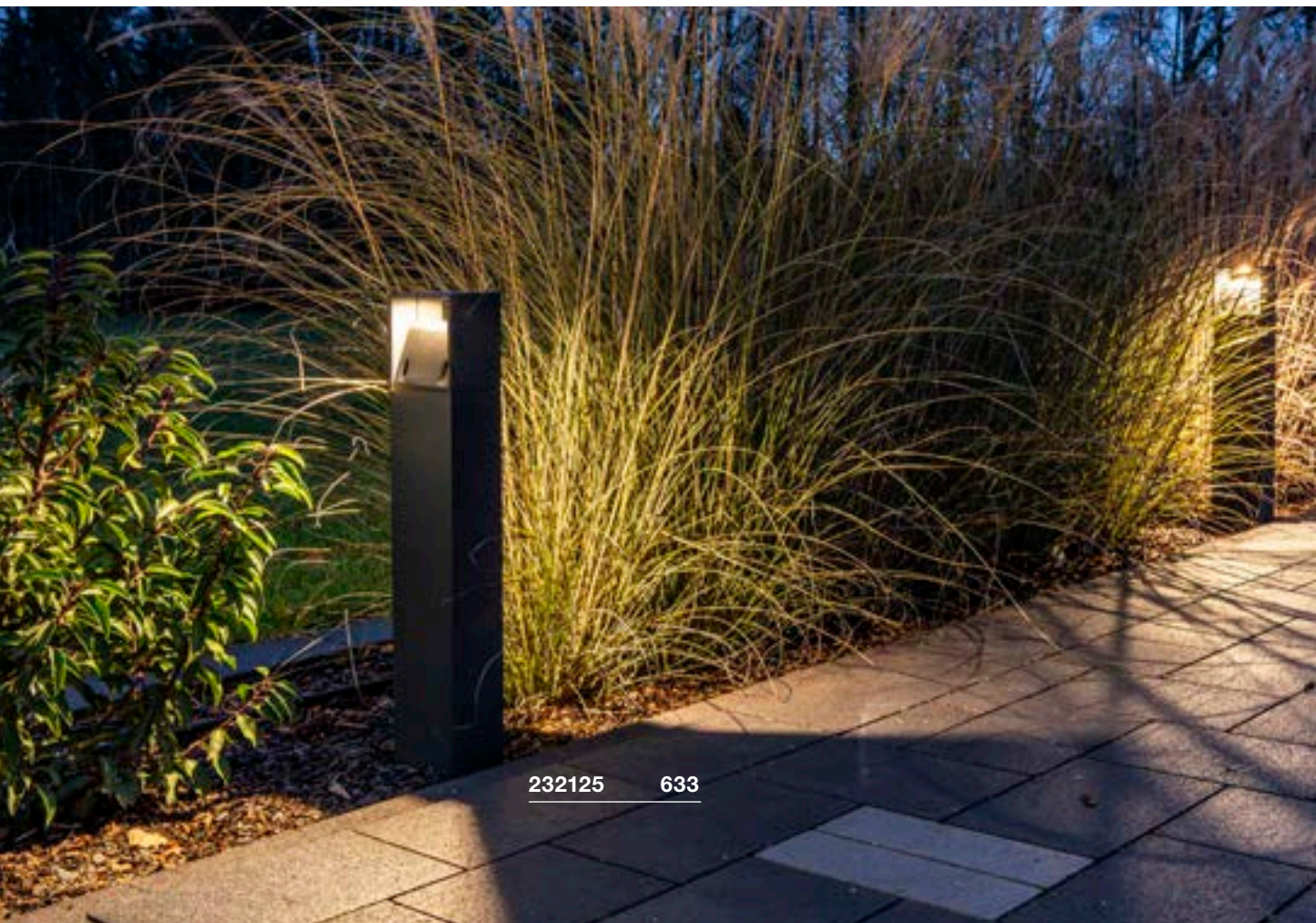

232125

633





### LOGS 40 Pole

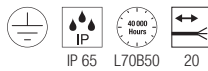
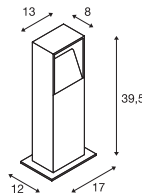

220-240V ~50/60Hz | 500mA  
Potência total: 9,5W  
Material: alumínio

- Extremidade do cabo aberta



Down 570lm | 3000K

Variante	Art. n.º	EUR
● Antracite	232115	259,00



Artigo	Art. n.º	EUR
Âncora de betão		
● Cinzento	232119	61,00
Estaca		
● Cinzento	231230	45,50
Jogo de parafusos		
● Aço inoxidável	228754	4,50
Caixa de ligação IP68, 3 polos		
● Preto	228730	23,00

### LOGS 70 Pole

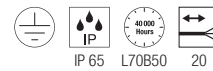
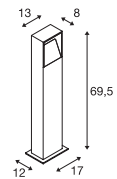

220-240V ~50/60Hz | 500mA  
Potência total: 9,5W  
Material: alumínio

- Extremidade do cabo aberta



Down 570lm | 3000K

Variante	Art. n.º	EUR
● Antracite	232125	299,00



Artigo	Art. n.º	EUR
Âncora de betão		
● Cinzento	232119	61,00
Estaca		
● Cinzento	231230	45,50
Jogo de parafusos		
● Aço inoxidável	228754	4,50
Caixa de ligação IP68, 3 polos		
● Preto	228730	23,00

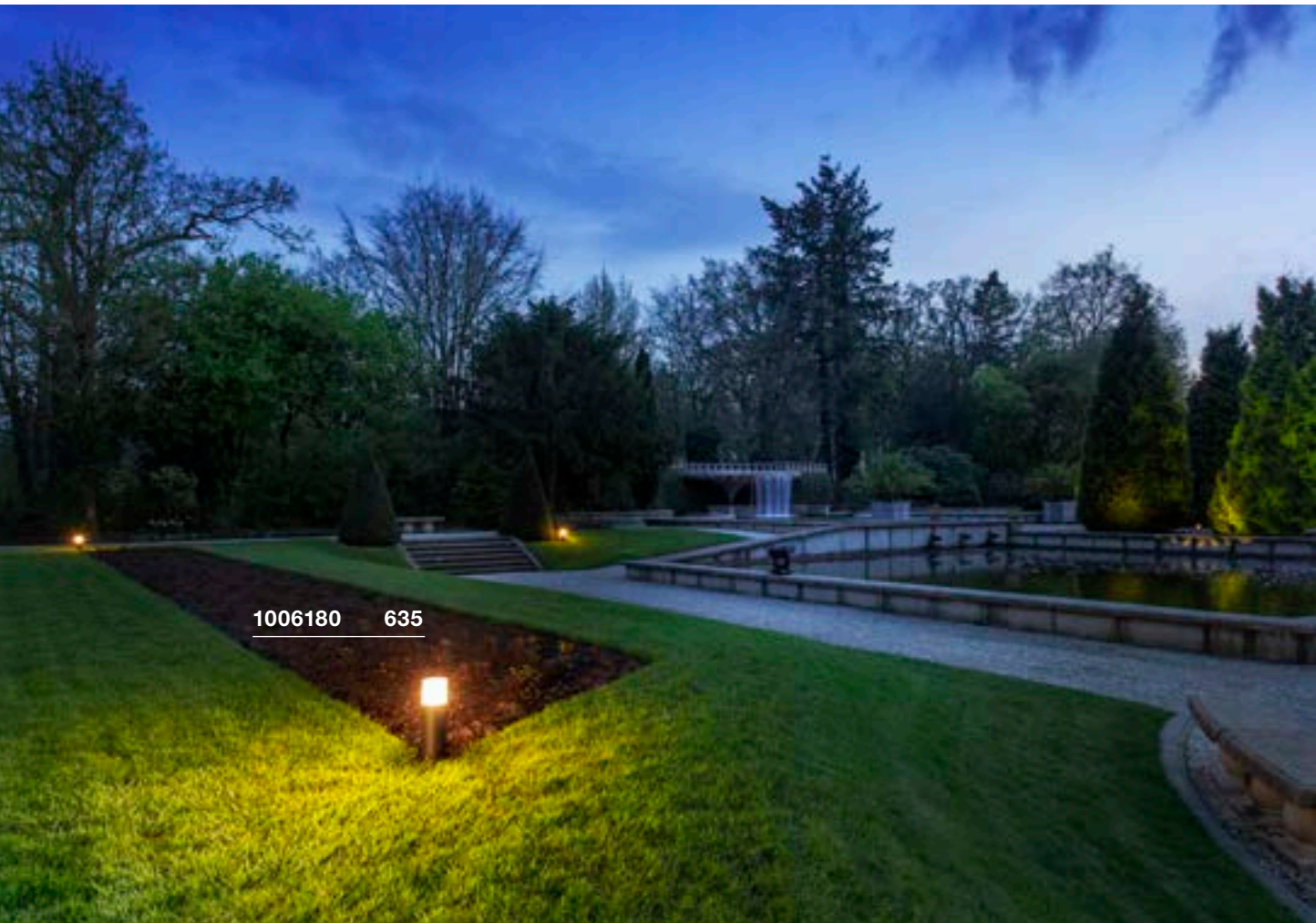



**GRAFIT 30**  
Pole, Redondo, E27

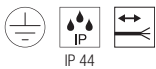
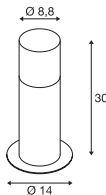

220-240V ~50/60Hz  
Material: alumínio/acrílico

- Extremidade do cabo aberta



Casquilho: 1xE27 Máx. Ø: 6 cm | C: 11,5 cm

Variante	Art. n.º	EUR
● Antracite	1006180	80,00



LED E27 | 8W | 240°  
3000K | 880lm | EE=E  
8kWh/1000h



Art. N.º: 1005289 | 10,25 EUR



Artigo	Art. n.º	EUR
Caixa de ligação IP68, 3 polos		
● Preto	228730	23,00

**GRAFIT 60**  
Pole, Redondo, E27

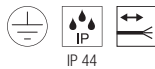
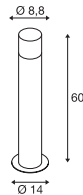

220-240V ~50/60Hz  
Material: alumínio/acrílico

- Extremidade do cabo aberta



Casquilho: 1xE27 Máx. Ø: 6 cm | C: 11,5 cm

Variante	Art. n.º	EUR
● Antracite	1006181	100,00



LED E27 | 8W | 240°  
3000K | 880lm | EE=E  
8kWh/1000h



Art. N.º: 1005289 | 10,25 EUR



Artigo	Art. n.º	EUR
Caixa de ligação IP68, 3 polos		
● Preto	228730	23,00

**GRAFIT 90**  
Pole, Redondo, E27

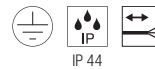
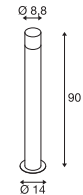

220-240V ~50/60Hz  
Material: alumínio/acrílico

- Extremidade do cabo aberta



Casquilho: 1xE27 Máx. Ø: 6 cm | C: 11,5 cm

Variante	Art. n.º	EUR
● Antracite	1006182	131,00



LED E27 | 8W | 240°  
3000K | 880lm | EE=E  
8kWh/1000h



Art. N.º: 1005289 | 10,25 EUR



Artigo	Art. n.º	EUR
Caixa de ligação IP68, 3 polos		
● Preto	228730	23,00



231225 637



1006184 637



### GRAFIT 30

Pole, E27

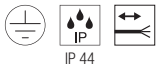
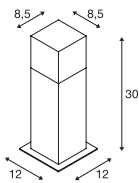

220-240V ~50/60Hz  
Material: alumínio/plástico

- Extremidade do cabo aberta



Casquilho: 1xE27 Máx. Ø: 6 cm C: 11,5 cm

Variante	Art. n.º	EUR
● Antracite	231215	80,00



LED E27 | 8W | 240°  
3000K | 880lm | EE=E  
8kWh/1000h



Art. N.º: 1005289 | 10,25 EUR



Artigo	Art. n.º	EUR
Estaca		
● Cinzento	231230	45,50
Jogo de parafusos		
● Aço inoxidável	228754	4,50
Caixa de ligação IP68, 3 polos		
● Preto	228730	23,00

### GRAFIT 60

Pole, E27

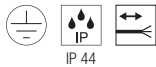
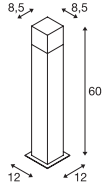

220-240V ~50/60Hz  
Material: alumínio/plástico

- Extremidade do cabo aberta



Casquilho: 1xE27 Máx. Ø: 6 cm C: 11,5 cm

Variante	Art. n.º	EUR
● Antracite	231225	100,00



LED E27 | 8W | 240°  
3000K | 880lm | EE=E  
8kWh/1000h



Art. N.º: 1005289 | 10,25 EUR



Artigo	Art. n.º	EUR
Estaca		
● Cinzento	231230	45,50
Jogo de parafusos		
● Aço inoxidável	228754	4,50
Caixa de ligação IP68, 3 polos		
● Preto	228730	23,00

### GRAFIT 90

Pole, E27

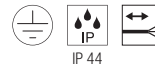
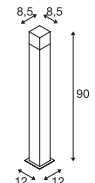

220-240V ~50/60Hz  
Material: alumínio/acrílico

- Extremidade do cabo aberta



Casquilho: 1xE27 Máx. Ø: 6 cm C: 11,5 cm

Variante	Art. n.º	EUR
● Antracite	1006184	131,00



LED E27 | 8W | 240°  
3000K | 880lm | EE=E  
8kWh/1000h



Art. N.º: 1005289 | 10,25 EUR



Artigo	Art. n.º	EUR
Estaca		
● Cinzento	231230	45,50
Caixa de ligação IP68, 3 polos		
● Preto	228730	23,00



1005442 639



## QUADRULO FL

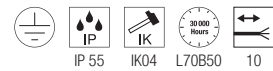
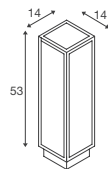

100-277V ~50/60Hz | 480mA  
Potência total: 7W  
Material: alumínio/acrílico

- Caixa de ligação IP



Down

340lm | 3000K

Variante	Art. n.º	EUR
● Antracite	1005442	166,00

## RUSTY® SLOT 50

Pole

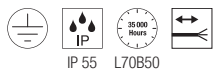
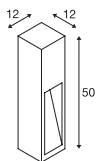

220-240V ~50/60Hz  
Potência total: 9W  
Material: aço corten/policarbonato (PC)

- Extremidade do cabo aberta



Down 30lm | 3000K

Variante	Art. n.º	EUR
● Oxidado	233447	309,00



Artigo	Art. n.º	EUR
Estaca		
● Cinzento	231230	45,50
Caixa de ligação IP68, 3 polos		
● Preto	228730	23,00

## RUSTY® SLOT 80

Pole

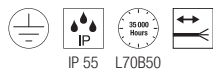
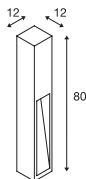

220-240V ~50/60Hz  
Potência total: 9W  
Material: aço corten/policarbonato (PC)

- Extremidade do cabo aberta



Down 30lm | 3000K

Variante	Art. n.º	EUR
● Oxidado	233457	389,00



Artigo	Art. n.º	EUR
Estaca		
● Cinzento	231230	45,50
Caixa de ligação IP68, 3 polos		
● Preto	228730	23,00



229410 641



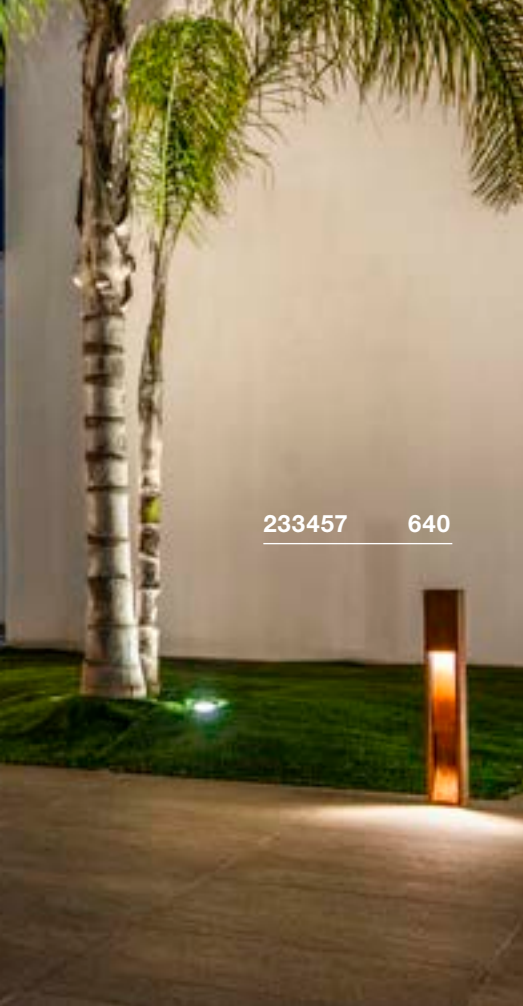

233457 640



229411 641

### RUSTY® SLOT 50

Pole, E27

### RUSTY® SLOT 80

Pole, E27

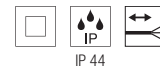
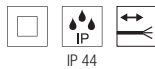
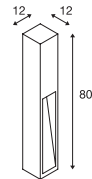
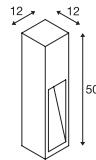

220-240V ~50/60Hz  
Material: aço corten/policarbonato (PC)

220-240V ~50/60Hz  
Material: aço corten/policarbonato (PC)

- Extremidade do cabo aberta

- Extremidade do cabo aberta



Casquilho: 1xE27 Máx. Ø: 4,8 cm | C: 13,9 cm

Casquilho: 1xE27 Máx. Ø: 4,8 cm | C: 13,9 cm

Variante	Art. n.º	EUR
● Oxidado	229410	286,00

Variante	Art. n.º	EUR
● Oxidado	229411	360,00



LED E27 | 8W | 240°  
3000K | 880lm | EE=E  
8kWh/1000h



Art. N.º: 1005289 | 10,25 EUR



LED E27 | 8W | 240°  
4000K | 920lm | EE=E  
8kWh/1000h



Art. N.º: 1005290 | 10,25 EUR



Artigo	Art. n.º	EUR
Estaca		
● Cinzento	231230	45,50
Caixa de ligação IP68, 3 polos		
● Preto	228730	23,00



Artigo	Art. n.º	EUR
Estaca		
● Cinzento	231230	45,50
Caixa de ligação IP68, 3 polos		
● Preto	228730	23,00



233090 642



229420 643

## RUSTY® PATHLIGHT Pole, TCR-TSE

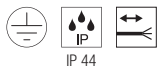
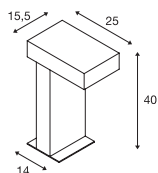

220-240V ~50/60Hz  
Material: aço corten/policarbonato (PC)

- Extremidade do cabo aberta



Casquinho: 1xGX53 Máx. Ø: 7,5 cm | C: 2,7 cm

Variante	Art. n.º	EUR
● Oxidado	230090	312,00



LED GX53 | 6,1W | 120°  
3000K | 490lm | EE=G  
6kWh/1000h



Art. N.º: 1005271 | 11,50 EUR



Artigo	Art. n.º	EUR
Estaca		
● Cinzento	229422	45,50
Caixa de ligação IP68, 3 polos		
● Preto	228730	23,00

## RUSTY® 40 Pole

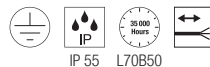
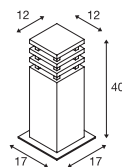

220-240V ~50/60Hz  
Potência total: 9W  
Material: aço corten/policarbonato (PC)

- Extremidade do cabo aberta



Down 90lm | 3000K

Variante	Art. n.º	EUR
● Oxidado	233427	309,00



Artigo	Art. n.º	EUR
Estaca		
● Cinzento	229422	45,50
Caixa de ligação IP68, 3 polos		
● Preto	228730	23,00



RUSTY® 70  
Pole

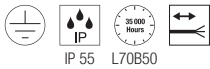
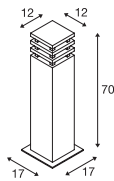

220-240V ~50/60Hz  
Potência total: 9W  
Material: aço corten/policarbonato (PC)

- Extremidade do cabo aberta



Down 90lm | 3000K

Variante	Art. n.º	EUR
● Oxidado	233437	389,00



Artigo	Art. n.º	EUR
Estaca		
● Cinzento	229422	45,50
Caixa de ligação IP68, 3 polos		
● Preto	228730	23,00

RUSTY® 40  
Pole, E27

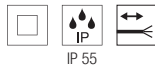
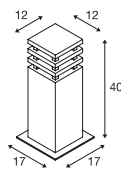

220-240V ~50/60Hz  
Material: aço corten/policarbonato (PC)

- Extremidade do cabo aberta



Casquilho: 1xE27 Máx. Ø: 4,8 cm | C: 13,9 cm

Variante	Art. n.º	EUR
● Oxidado	229420	286,00



LED E27 | 8W | 240°  
3000K | 880lm | EE=E  
8kWh/1000h



Art. N.º: 1005289 | 10,25 EUR



Artigo	Art. n.º	EUR
Estaca		
● Cinzento	229422	45,50
Caixa de ligação IP68, 3 polos		
● Preto	228730	23,00

RUSTY® 70  
Pole, E27

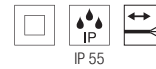
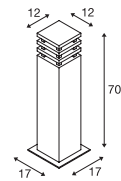

220-240V ~50/60Hz  
Material: aço corten/policarbonato (PC)

- Extremidade do cabo aberta



Casquilho: 1xE27 Máx. Ø: 4,8 cm | C: 13,9 cm

Variante	Art. n.º	EUR
● Oxidado	229421	360,00



LED E27 | 8W | 240°  
4000K | 920lm | EE=E  
8kWh/1000h



Art. N.º: 1005290 | 10,25 EUR



Artigo	Art. n.º	EUR
Estaca		
● Cinzento	229422	45,50
Caixa de ligação IP68, 3 polos		
● Preto	228730	23,00

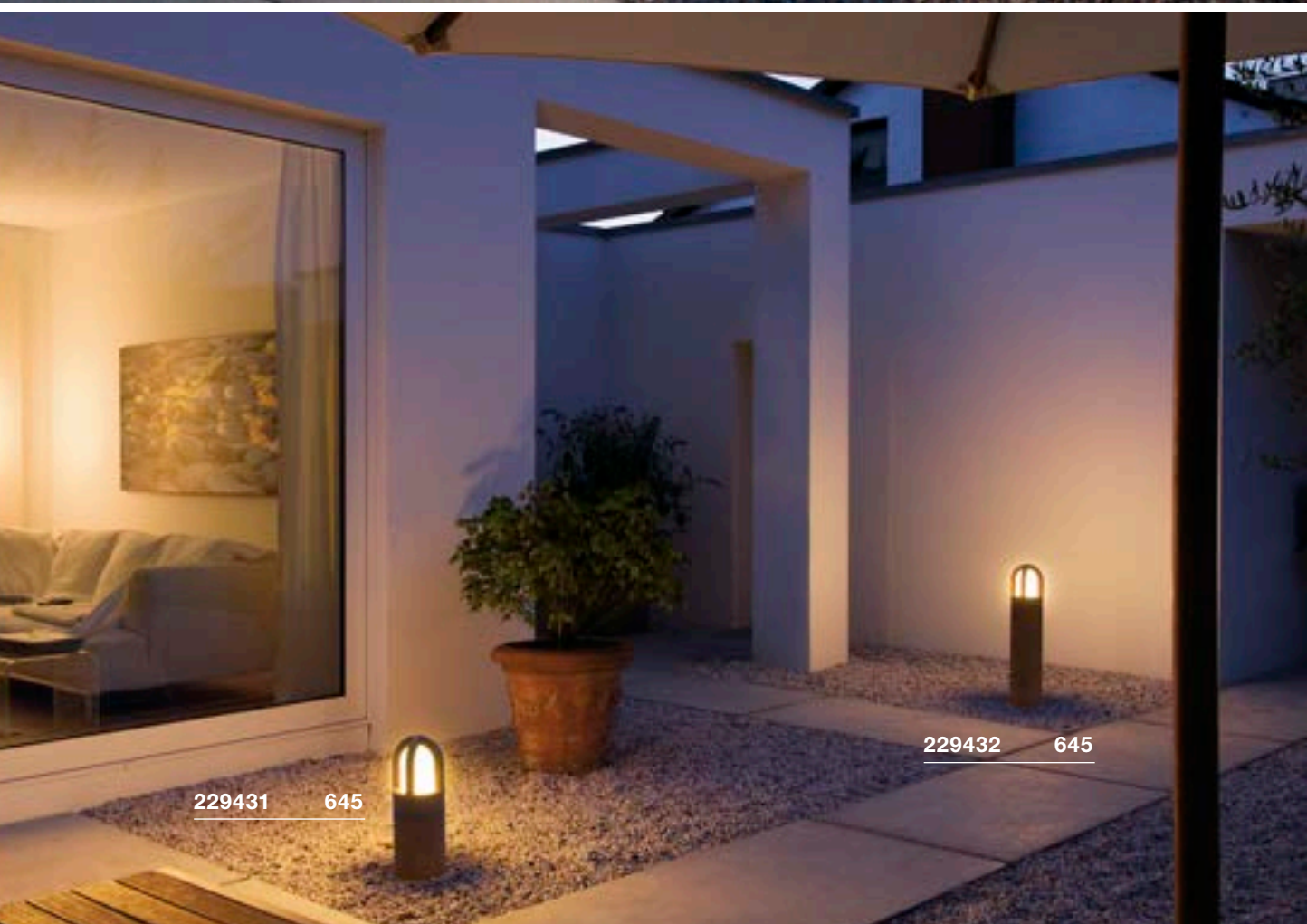



### RUSTY® CONE 24 FL, E14

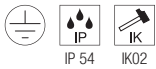
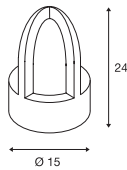

220-240V ~50/60Hz  
Material: aço corten/vidro



Casquilho: 1xE14 Máx. Ø: 4,8 cm | C: 13,9 cm

Variante	Art. n.º	EUR
● Oxidado	229430	276,00



C35 | 4,2W | 320°  
2700K | 350lm | EE=G  
5kWh/1000h



Art. N.º: 1005285 | 8,50 EUR

### RUSTY® CONE 40 Pole, E27

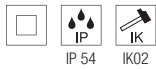
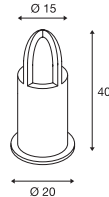

220-240V ~50/60Hz  
Material: aço corten/vidro



Casquilho: 1xE27 Máx. Ø: 4,8 cm | C: 13,9 cm

Variante	Art. n.º	EUR
● Oxidado	229431	419,00



LED E27 | 8W | 240°  
3000K | 880lm | EE=E  
8kWh/1000h



Art. N.º: 1005289 | 10,25 EUR



Artigo	Art. n.º	EUR
Estaca		
● Cinzento	229422	45,50
Caixa de ligação IP68, 3 polos		
● Preto	228730	23,00

### RUSTY® CONE 70 Pole, E27

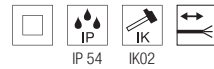
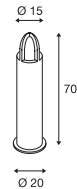

220-240V ~50/60Hz  
Material: aço corten/policarbonato (PC)



Casquilho: 1xE27 Máx. Ø: 4,8 cm | C: 13,9 cm

Variante	Art. n.º	EUR
● Oxidado	229432	499,00



LED E27 | 8W | 240°  
3000K | 880lm | EE=E  
8kWh/1000h



Art. N.º: 1005289 | 10,25 EUR



Artigo	Art. n.º	EUR
Estaca		
● Cinzento	229422	45,50
Caixa de ligação IP68, 3 polos		
● Preto	228730	23,00

- Extremidade do cabo aberta

RUSTY® 40  
Pole, E27

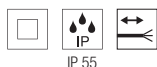
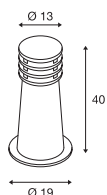

220-240V ~50/60Hz  
Material: aço corten/policarbonato (PC)

- Extremidade do cabo aberta



Casquilho: 1xE27 Máx. Ø: 4,8 cm | C: 13,9 cm

Variante	Art. n.º	EUR
● Oxidado	229020	286,00



LED E27 | 8W | 240°  
4000K | 920lm | EE=E  
8kWh/1000h



Art. N.º: 1005290 | 10,25 EUR



Artigo	Art. n.º	EUR
Estaca		
● Aço inoxidável	229022	49,50
Caixa de ligação IP68, 3 polos		
● Preto	228730	23,00

RUSTY® 70  
Pole, E27

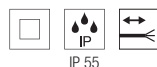
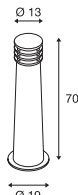

220-240V ~50/60Hz  
Material: aço corten/policarbonato (PC)

- Extremidade do cabo aberta



Casquilho: 1xE27 Máx. Ø: 4,8 cm | C: 13,9 cm

Variante	Art. n.º	EUR
● Oxidado	229021	360,00



LED E27 | 8W | 240°  
3000K | 880lm | EE=E  
8kWh/1000h



Art. N.º: 1005289 | 10,25 EUR



Artigo	Art. n.º	EUR
Estaca		
● Aço inoxidável	229022	49,50
Caixa de ligação IP68, 3 polos		
● Preto	228730	23,00



229020 646

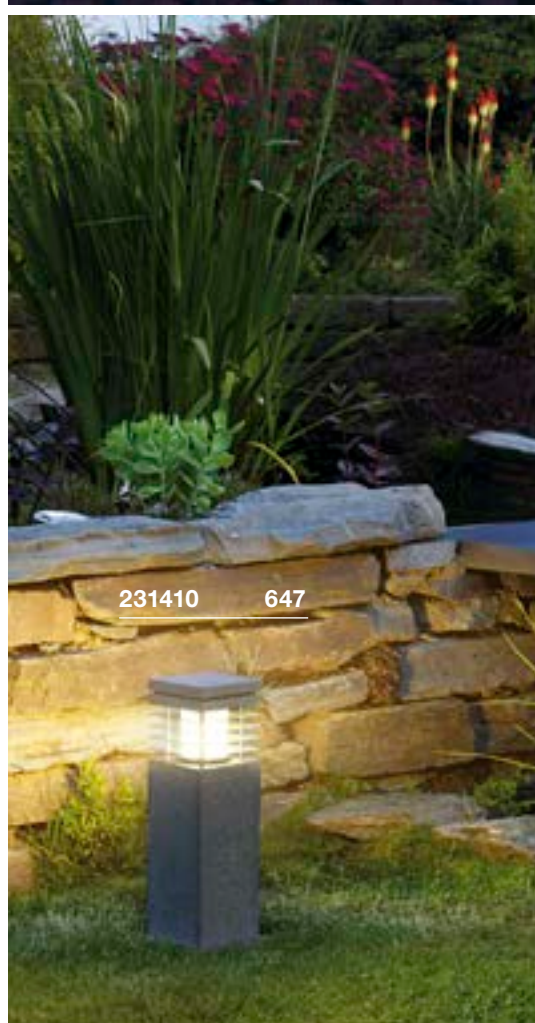

231410 647



229021 646



231411 647

### ARROCK GRANITE 40

Pole, square, E27

### ARROCK GRANITE 70

Pole, square, E27

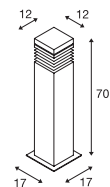
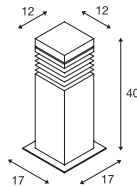

IP 44

220-240V ~50/60Hz  
Material: granito/aço inoxidável 304



IP 44

220-240V ~50/60Hz  
Material: granito/aço inoxidável 304



Casquilho: 1xE27 Máx. Ø: 5,2 cm | C: 11,5 cm

Variante	Art. n.º	EUR
● Cinzento	231410	359,00



LED E27 | 8W | 240°  
3000K | 880lm | EE=E  
8kWh/1000h



Art. N.º: 1005289 | 10,25 EUR



Casquilho: 1xE27 Máx. Ø: 5,2 cm | C: 11,5 cm

Variante	Art. n.º	EUR
● Cinzento	231411	434,00



LED E27 | 8W | 240°  
4000K | 920lm | EE=E  
8kWh/1000h



Art. N.º: 1005290 | 10,25 EUR



Artigo	Art. n.º	EUR
Estaca		
● Aço inoxidável	229022	49,50
Caixa de ligação IP68, 3 polos		
● Preto	228730	23,00



Artigo	Art. n.º	EUR
Estaca		
● Aço inoxidável	229022	49,50
Caixa de ligação IP68, 3 polos		
● Preto	228730	23,00

# ARROCK ARC

Pole, QPAR51



231420 648

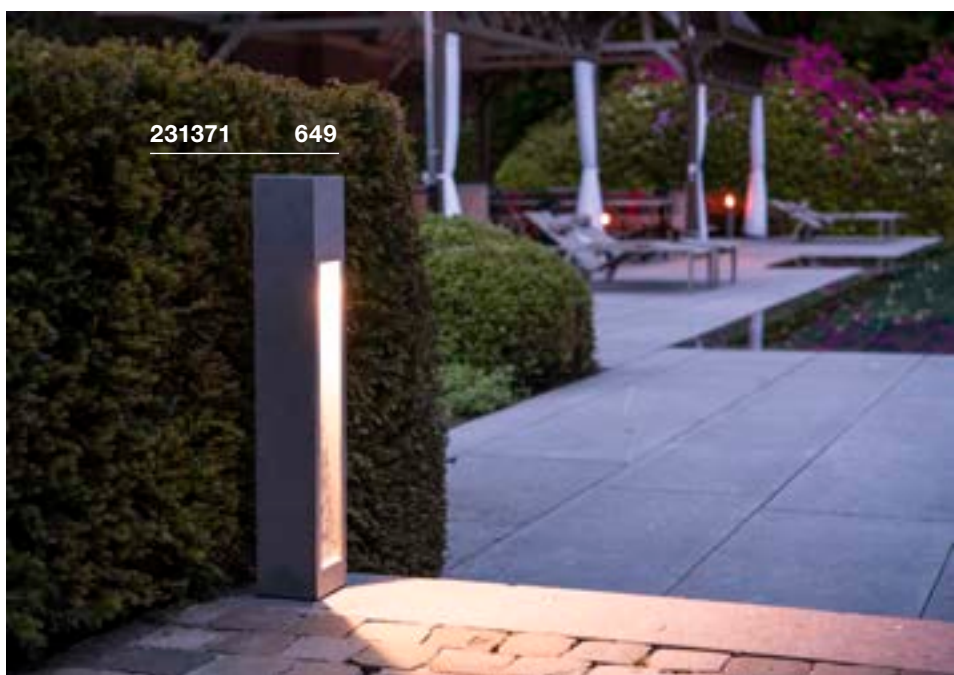
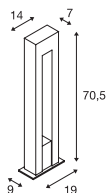

231371 649

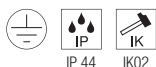

220-240V ~50/60Hz  
Material: granito/aço inoxidável 304



Casquilho: 1xGU10 Máx. Ø: 5,1 cm | C: 7,6 cm

Variante	Art. n.º	EUR
● Cinzento	231420	359,00



LED GU10 51mm | 6W | 38°  
2700K | 450lm | EE=F  
6kWh/1000h



Art. N.º: 1005075 | 7,50 EUR



Artigo	Art. n.º	EUR
Estaca		
● Cinzento	231233	49,50



231440 649





### ARROCK STONE 50 Pole

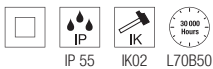
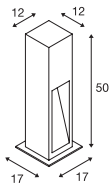

220-240V ~50/60Hz | 700mA  
Potência total: 9W  
Material: basalto/ aço inoxidável 304



Down 330lm | 3000K

Variante	Art. n.º	EUR
● Cinzento	231370	413,00



Artigo	Art. n.º	EUR
Estaca		
● Cinzento	231233	49,50

### ARROCK STONE 75 Pole

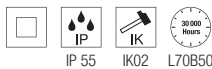
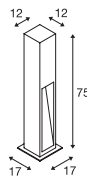

220-240V ~50/60Hz | 700mA  
Potência total: 9W  
Material: basalto/ aço inoxidável 304



Down 330lm | 3000K

Variante	Art. n.º	EUR
● Cinzento	231371	474,00



Artigo	Art. n.º	EUR
Estaca		
● Cinzento	231233	49,50

### ARROCK SLOT Pole, QPAR51

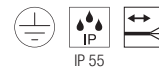
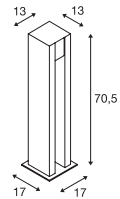

220-240V ~50/60Hz  
Material: granito/aço inoxidável 304

- Extremidade do cabo aberta



Casquilho: 1xGU10

Variante	Art. n.º	EUR
● Cinzento	231440	413,00



LED GU10 51mm | 6W | 38°  
2700K | 450lm | EE=F  
6kWh/1000h



Art. N.º: 1005076 | 7,50 EUR



Artigo	Art. n.º	EUR
Estaca		
● Cinzento	231235	49,50
Caixa de ligação IP68, 3 polos		
● Preto	228730	23,00



1003535 651

## L-LINE OUT 30 FL, vertical

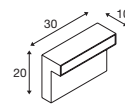

1003538 651



220-240V ~50/60Hz | 500mA  
Potência total: 11,5W  
Material: alumínio / policarbonato (PC)

- A temperatura de cor da luz deve ser definida antes da instalação
- Extremidade do cabo aberta



Down 800lm | 3000K | 810lm | 4000K

Variante	Art. n.º	EUR
● Antracite	1003536	232,00



Artigo	Art. n.º	EUR
Caixa de ligação IP68, 3 polos		
● Preto	228730	23,00



### L-LINE OUT 60 FL, vertical

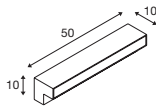

220-240V ~50/60Hz | 500mA  
Potência total: 11,5W  
Material: alumínio / policarbonato (PC)

- A temperatura de cor da luz deve ser definida antes da instalação
- Extremidade do cabo aberta



Down 780lm | 3000K | 800lm | 4000K

Variante	Art. n.º	EUR
● Antracite	1003535	242,00



Artigo	Art. n.º	EUR
Caixa de ligação IP68, 3 polos		
● Preto	228730	23,00

### L-LINE OUT 50 Pole, horizontal

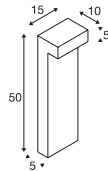

220-240V ~50/60Hz | 350mA  
Potência total: 7W  
Material: alumínio / policarbonato (PC)

- A temperatura de cor da luz deve ser definida antes da instalação
- Extremidade do cabo aberta



Down 490lm | 3000K | 530lm | 4000K

Variante	Art. n.º	EUR
● Antracite	1003537	191,00



Artigo	Art. n.º	EUR
Caixa de ligação IP68, 3 polos		
● Preto	228730	23,00

### L-LINE OUT 80 Pole, horizontal

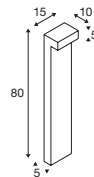

220-240V ~50/60Hz | 350mA  
Potência total: 7W  
Material: alumínio / policarbonato (PC)

- A temperatura de cor da luz deve ser definida antes da instalação
- Extremidade do cabo aberta



Down 490lm | 3000K | 530lm | 4000K

Variante	Art. n.º	EUR
● Antracite	1003538	222,00



Artigo	Art. n.º	EUR
Caixa de ligação IP68, 3 polos		
● Preto	228730	23,00

# THEO PATHLIGHT

Pole, double

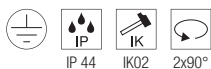
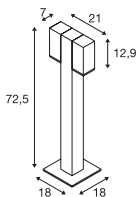

220-240V ~50/60Hz  
Material: alumínio



Casquilho: 2xGU10

Variante	Art. n.º	EUR
● Antracite	1002871	239,00



LED GU10 51mm | 6W | 38°  
2700K | 450lm | EE=F  
6kWh/1000h



Art. N.º: 1005077 | 7,50 EUR



Artigo	Art. n.º	EUR
Caixa de ligação IP68, 3 polos		
● Preto	228730	23,00

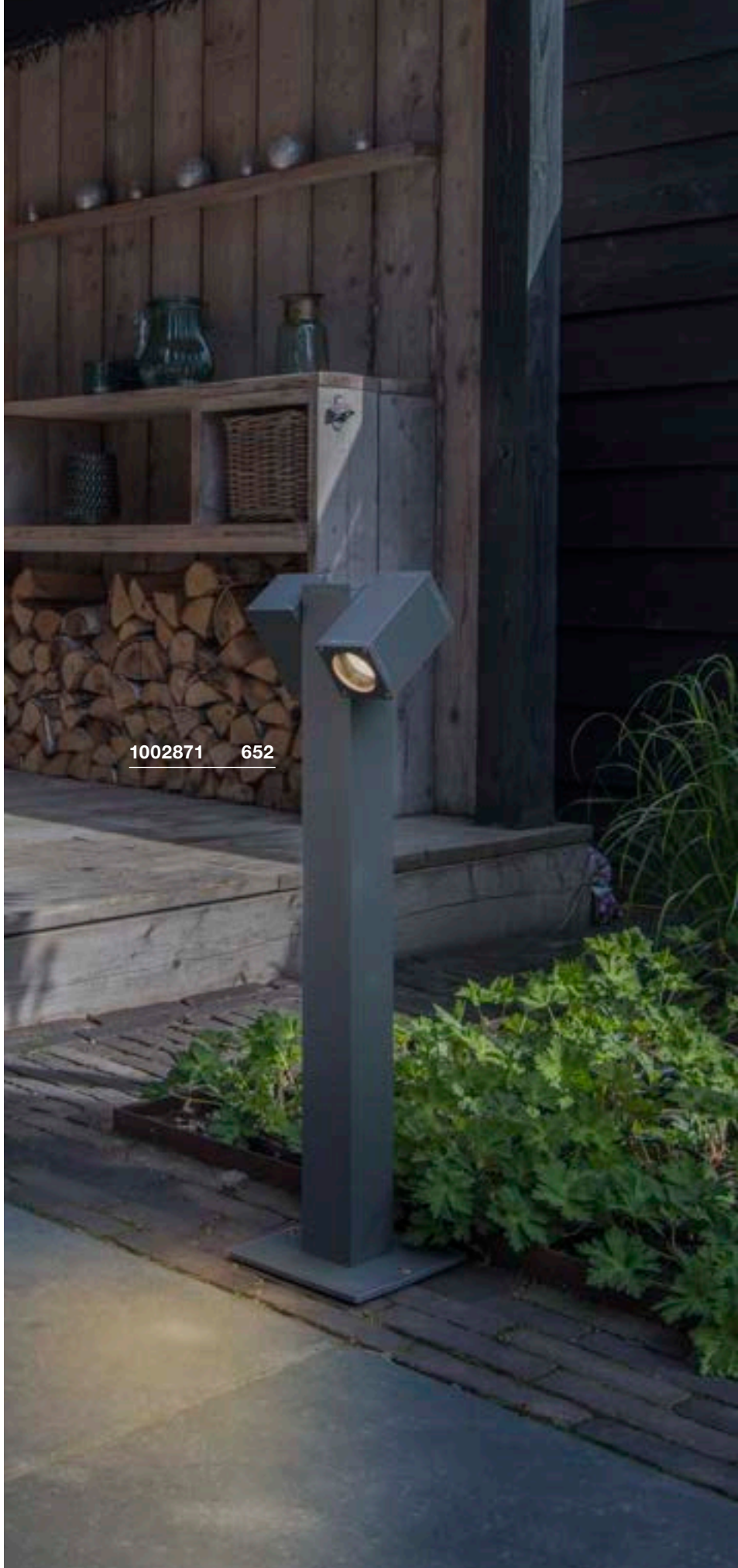

1002871 652



### OVALISK 75 Pole

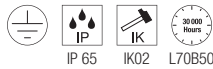
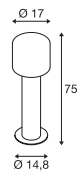

220-240V ~50/60Hz | 500mA  
Potência total: 9,2W  
Material: alumínio/vidro



Down 580lm | 3000K | 630lm | 4000K

Variante	Art. n.º	EUR
● Antracite	1004680	332,00



Artigo	Art. n.º	EUR
Âncora de betão		
● Prateado	228712	64,00
Estaca		
● Cinzento	228722	58,00
Caixa de ligação IP68, 3 polos		
● Preto	228730	23,00

### OVALISK 100 Pole

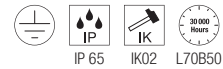
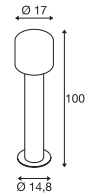

220-240V ~50/60Hz | 500mA  
Potência total: 9,2W  
Material: alumínio/vidro



Down 580lm | 3000K | 630lm | 4000K

Variante	Art. n.º	EUR
● Antracite	1004681	362,00

1004680 653



1002000 655

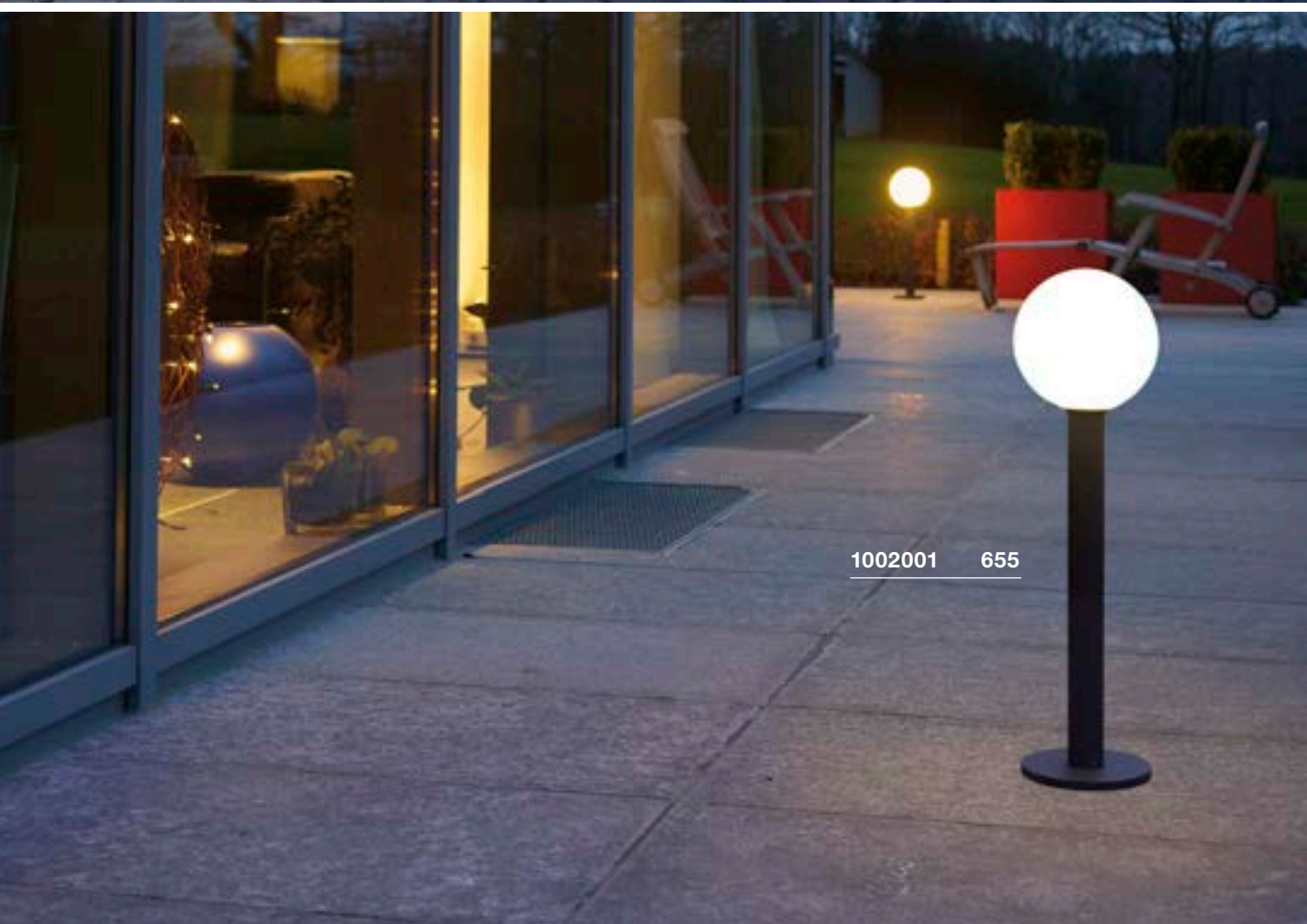

1002001 655



**GLOO PURE 27**  
Pole, E27

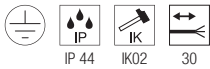
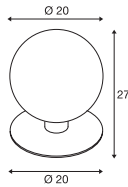

220-240V ~50/60Hz  
Material: alumínio/vidro

- Extremidade do cabo aberta



Casquilho: 1xE27 Máx. Ø: 4,8 cm | C: 18 cm

Variante	Art. n.º	EUR
● Antracite	1001999	93,00



| 13,5W | 240°  
3000K | 1520lm | EE=E  
14kWh/1000h



Art. N.º: 1005307 | 12,50 EUR



Artigo	Art. n.º	EUR
Estaca		
● Cinzento	231234	52,00
Caixa de ligação IP68, 3 polos		
● Preto	228730	23,00

**GLOO PURE 44**  
Pole, E27

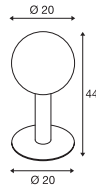

220-240V ~50/60Hz  
Material: alumínio/vidro

- Extremidade do cabo aberta



Casquilho: 1xE27 Máx. Ø: 4,8 cm | C: 18 cm

Variante	Art. n.º	EUR
● Antracite	1002000	124,00



LED E27 | 8W | 240°  
3000K | 880lm | EE=E  
8kWh/1000h



Art. N.º: 1005289 | 10,25 EUR



Artigo	Art. n.º	EUR
Estaca		
● Cinzento	231234	52,00
Caixa de ligação IP68, 3 polos		
● Preto	228730	23,00

**GLOO PURE 70**  
Pole, E27

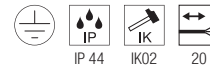
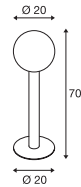

220-240V ~50/60Hz  
Material: alumínio/vidro

- Extremidade do cabo aberta



Casquilho: 1xE27 Máx. Ø: 4,8 cm | C: 18 cm

Variante	Art. n.º	EUR
● Antracite	1002001	136,00



| 13,5W | 240°  
3000K | 1520lm | EE=E  
14kWh/1000h



Art. N.º: 1005307 | 12,50 EUR



Artigo	Art. n.º	EUR
Estaca		
● Cinzento	231234	52,00
Caixa de ligação IP68, 3 polos		
● Preto	228730	23,00



227221    657

227219    657





ROTOBALL 25  
FL, E27

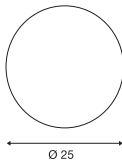

220-240V ~50/60Hz  
Material: aço/polietileno (PE)

- Ficha IP44



Casquilho: 1xE27

Variante	Art. n.º	EUR
○ Branco	227219	161,00



A60 | 7,5W | 320°  
2700K | 800lm | EE=F  
8kWh/1000h



Art. N.º: 1005303 | 9,60 EUR

ROTOBALL 40  
FL, E27

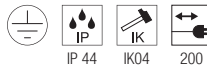
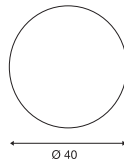

220-240V ~50/60Hz  
Material: aço/polietileno (PE)

- Ficha IP44



Casquilho: 1xE27

Máx. Ø: 9,5 cm

Variante	Art. n.º	EUR
○ Branco	227220	181,00



LED E27 | 8W | 240°  
3000K | 880lm | EE=E  
8kWh/1000h



Art. N.º: 1005289 | 10,25 EUR

ROTOBALL 50  
FL, E27

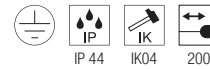
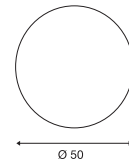

220-240V ~50/60Hz  
Material: aço/polietileno (PE)

- Ficha IP44



Casquilho: 1xE27

Máx. Ø: 9,5 cm

Variante	Art. n.º	EUR
○ Branco	227221	242,00



A60 | 7,5W | 320°  
2700K | 800lm | EE=F  
8kWh/1000h



Art. N.º: 1005303 | 9,60 EUR

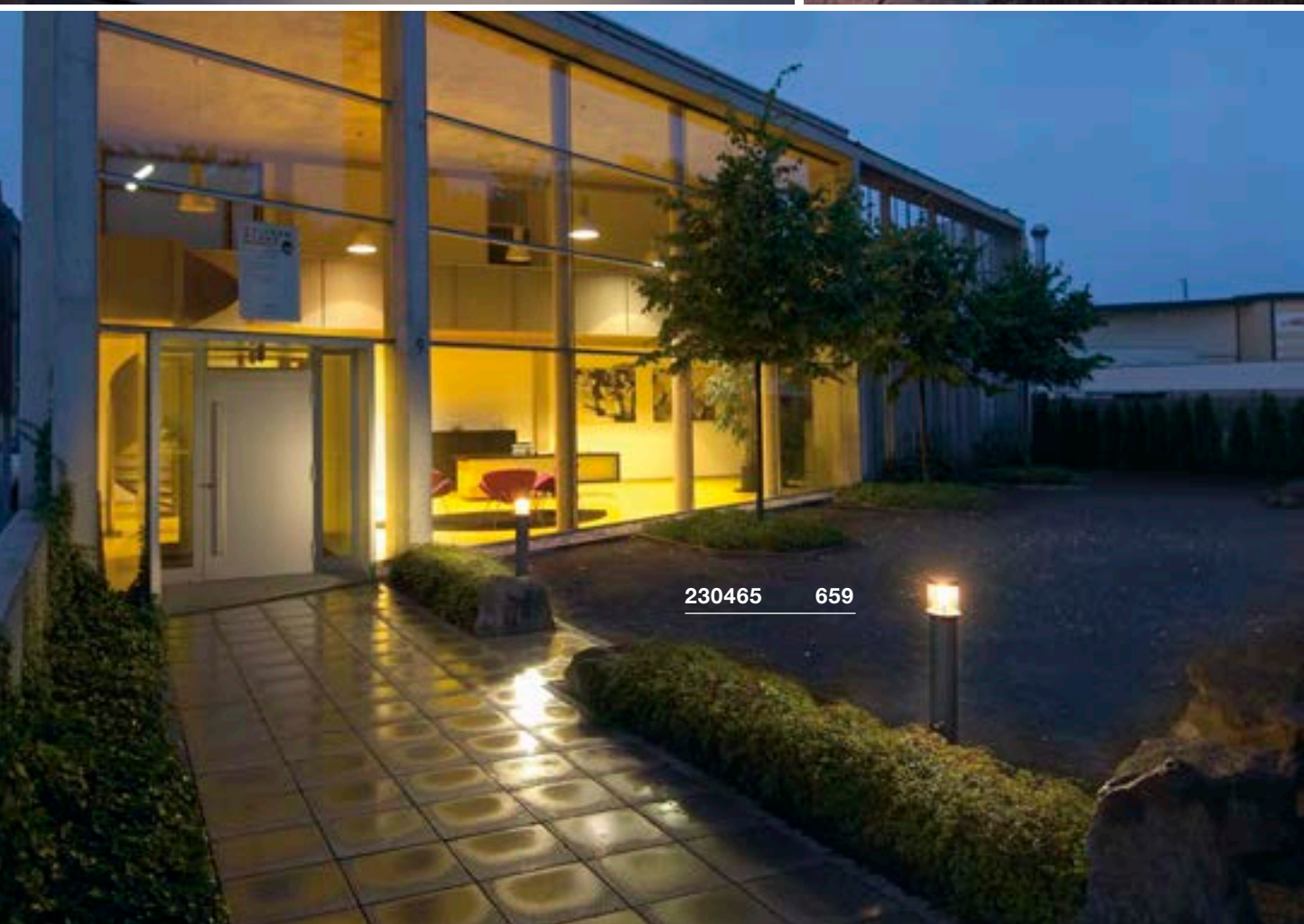
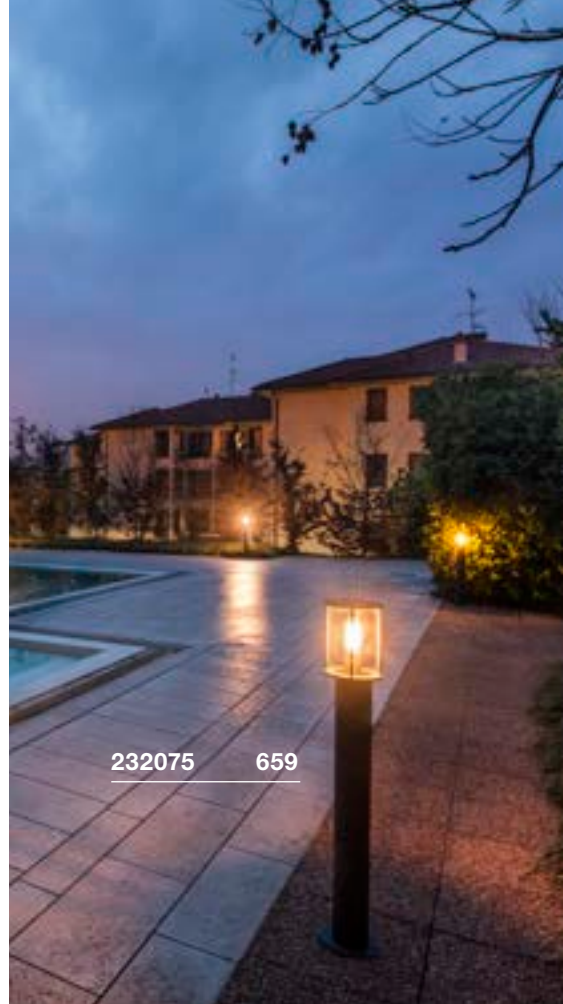



## PHOTONIA PD, E27

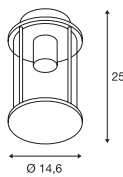

220-240V ~50/60Hz  
Material: alumínio/vidro

- Inclui corrente para suspensão
- Ficha IP44



Casquilho: 1xE27 Máx. Ø: 9 cm C: 15 cm

Variante	Art. n.º	EUR
● Antracite	232065	239,00



LED E27 | 7,5W | 320°  
2700K | 800lm | EE=F  
8kWh/1000h



Art. N.º: 1005268 | 12,25 EUR



Artigo	Art. n.º	EUR
Roseta para teto		
● Antracite	1000398	80,00

## PHOTONIA Pole, E27

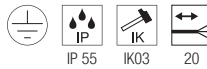

220-240V ~50/60Hz  
Material: alumínio/vidro

- Extremidade do cabo aberta



Casquilho: 1xE27 Máx. Ø: 9 cm C: 15 cm

Variante	Art. n.º	EUR
● Antracite	232075	275,00



LED E27 | 7,5W | 320°  
2500K | 700lm | EE=F  
8kWh/1000h



Art. N.º: 1005265 | 26,50 EUR



Artigo	Art. n.º	EUR
Âncora de betão		
● Aço inoxidável	232085	49,50
Caixa de ligação IP68, 3 polos		
● Preto	228730	23,00

## OTOS GLAS Pole, E27

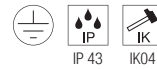
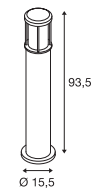

220-240V ~50/60Hz  
Material: alumínio/vidro

- Âncora de betão incluída.



Casquilho: 1xE27 Máx. Ø: 6,5 cm C: 14,5 cm

Variante	Art. n.º	EUR
● Antracite	230465	144,00



A60 | 7,5W | 320°  
2700K | 800lm | EE=F  
8kWh/1000h



Art. N.º: 1005303 | 9,60 EUR



Artigo	Art. n.º	EUR
Jogo de parafusos		
● Aço inoxidável	228753	9,25
Caixa de ligação IP68, 3 polos		
● Preto	228730	23,00

CUBIX  
FL, QPAR51

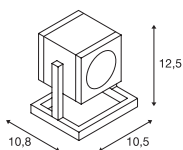

220-240V ~50/60Hz  
Material: alumínio/vidro



- Ficha IP44



Casquillo: 1xGU10

Variante	Art. n.º	EUR
● Antracite	132835	127,00

LED GU10 51mm | 6W | 38°  
2700K | 450lm | EE=F  
6kWh/1000h

Art. N.º: 1005077 | 7,50 EUR

CONE  
FL, E27

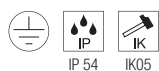
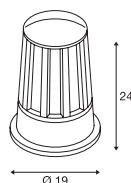

220-240V ~50/60Hz  
Material: alumínio/vidro



Casquillo: 1xE27 máx. C: 15 cm

Variante	Art. n.º	EUR
● Antracite	230435	100,00

LED E27 | 7,5W | 320°  
2500K | 700lm | EE=F  
8kWh/1000h



Art. N.º: 1005265 | 26,50 EUR





1000821 661



1000822 661

MOLAT  
PD, E27

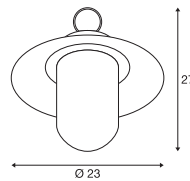

220-240V ~50/60Hz  
Material: alumínio/vidro

- Inclui corrente para suspensão
- Ficha IP44



Casquilho: 1xE27 Máx. Ø: 6,5 cm | C: 14,5 cm

Variante	Art. n.º	EUR
● Antracite	1000821	147,00



LED E27 | 7,5W | 320°  
2700K | 800lm | EE=F  
8kWh/1000h



Art. N.º: 1005268 | 12,25 EUR



Artigo	Art. n.º	EUR
Roseta para teto		
● Antracite	1000398	80,00

MOLAT  
Pole, E27

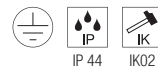
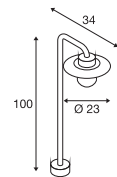

220-240V ~50/60Hz  
Material: alumínio/vidro



Casquilho: 1xE27 Máx. Ø: 6,5 cm | C: 14,5 cm

Variante	Art. n.º	EUR
● Antracite	1000822	181,00



LED E27 | 7,5W | 320°  
2500K | 700lm | EE=F  
8kWh/1000h



Art. N.º: 1005265 | 26,50 EUR



Artigo	Art. n.º	EUR
Estaca		
● Cinzento	230060	53,00

LISENNE 40  
Pole, E27

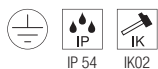
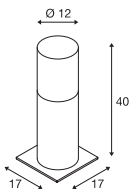

220-240V ~50/60Hz  
Material: basalto/vidro



Casquillo: 1xE27 Máx. Ø: 5,9 cm C: 15 cm

Variante	Art. n.º	EUR
● Cinzento	1000665	400,00



LED E27 | 7,5W | 320°  
2700K | 800lm | EE=F  
8kWh/1000h



Art. N.º: 1005268 | 12,25 EUR



Artigo	Art. n.º	EUR
Estaca		
● Cinzento	229422	45,50

LISENNE 70  
Pole, E27

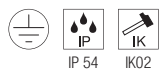
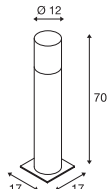

220-240V ~50/60Hz  
Material: basalto/vidro



Casquillo: 1xE27 Máx. Ø: 5,9 cm C: 15 cm

Variante	Art. n.º	EUR
● Cinzento	1000666	458,00



LED E27 | 7,5W | 320°  
2700K | 800lm | EE=F  
8kWh/1000h



Art. N.º: 1005268 | 12,25 EUR



Artigo	Art. n.º	EUR
Estaca		
● Cinzento	229422	45,50

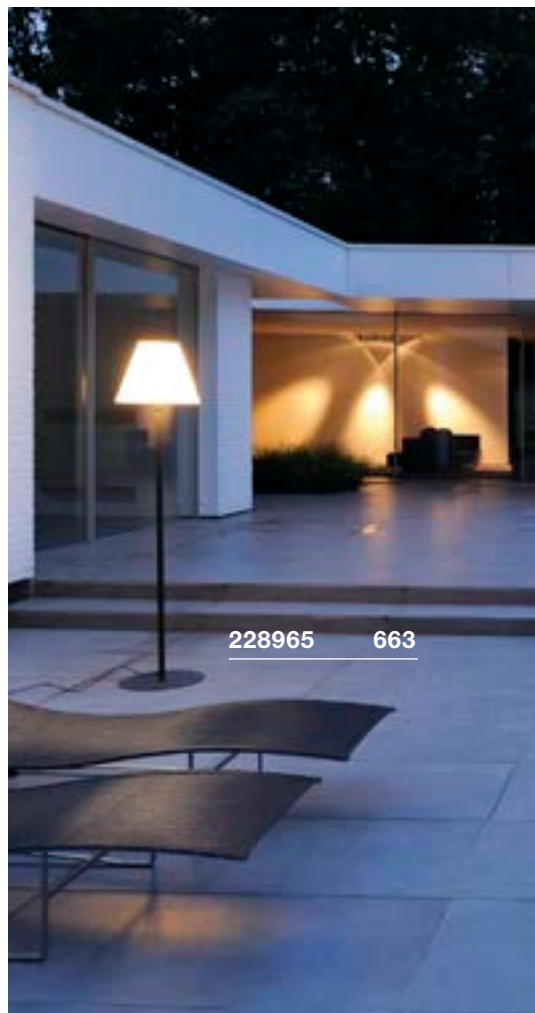

228965 663



ADEGAN MANILA  
FL, E27

ADEGAN  
FL, E27

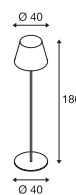
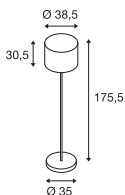

220-240V ~50/60Hz  
Material: granito/aço inoxidável

- Ficha IP44



Casquilho: 1xE27 Máx. Ø: 4,8 cm | C: 18 cm

Variante	Art. n.º	EUR
● aço inoxidável/ antracite	1002494	393,00



LED E27 | 8W | 240°  
3000K | 880lm | EE=E  
8kWh/1000h

Art. N.º: 1005289 | 10,25 EUR

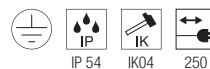

220-240V ~50/60Hz  
Material: alumínio / policarbonato (PC)

- Ficha IP44



Casquilho: 1xE27 Máx. Ø: 5,2 cm

Variante	Art. n.º	EUR
● Antracite	228965	303,00



LED E27 | 8W | 240°  
3000K | 880lm | EE=E  
8kWh/1000h

Art. N.º: 1005289 | 10,25 EUR



Artigo	Art. n.º	EUR
Estaca		
● Antracite	228960	36,00



228935    665



228925    665





**ALPA MUSHROOM 45**  
Pole, E27

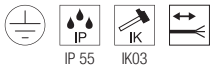
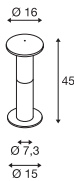

220-240V ~50/60Hz  
Material: alumínio / policarbonato (PC)

- Extremidade do cabo aberta



Casquilho: 1xE27 Máx. Ø: 5,2 cm | C: 16 cm

Variante	Art. n.º	EUR
● Antracite	228935	131,00



LED E27 | 8W | 240°  
3000K | 880lm | EE=E  
8kWh/1000h



Art. N.º: 1005289 | 10,25 EUR



Artigo	Art. n.º	EUR
Âncora de betão		
○ Prateado	228712	64,00
Estaca		
● Cinzento	228722	58,00
Caixa de ligação IP68, 3 polos		
● Preto	228730	23,00

**ALPA MUSHROOM 75**  
Pole, E27

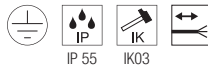
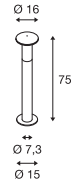

220-240V ~50/60Hz  
Material: alumínio / policarbonato (PC)

- Extremidade do cabo aberta



Casquilho: 1xE27 Máx. Ø: 5,2 cm | C: 16 cm

Variante	Art. n.º	EUR
● Antracite	228945	161,00



LED E27 | 8W | 240°  
3000K | 880lm | EE=E  
8kWh/1000h



Art. N.º: 1005289 | 10,25 EUR



Artigo	Art. n.º	EUR
Âncora de betão		
○ Prateado	228712	64,00
Estaca		
● Cinzento	228722	58,00
Caixa de ligação IP68, 3 polos		
● Preto	228730	23,00

**ALPA CONE 100**  
Pole, E27

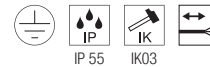
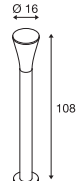

220-240V ~50/60Hz  
Material: alumínio / policarbonato (PC)

- Extremidade do cabo aberta



Casquilho: 1xE27 Máx. Ø: 5,2 cm | C: 17,5 cm

Variante	Art. n.º	EUR
● Antracite	228925	191,00



| 13,5W | 240°  
3000K | 1520lm | EE=E  
14kWh/1000h



Art. N.º: 1005307 | 12,50 EUR



Artigo	Art. n.º	EUR
Âncora de betão		
○ Prateado	228712	64,00
Estaca		
● Cinzento	228722	58,00
Caixa de ligação IP68, 3 polos		
● Preto	228730	23,00

APONI 90  
Pole, PHASE

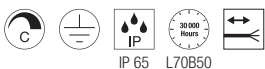
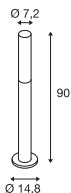

220-240V ~50/60Hz | 500mA  
Potência total: 6,3W  
Material: alumínio

- Extremidade do cabo aberta



Down 520lm | 3000K

Variante	Art. n.º	EUR
● Antracite	1000682	259,00



Artigo	Art. n.º	EUR
Caixa de ligação IP68, 3 polos		
● Preto	228730	23,00

APONI 120  
Pole, PHASE

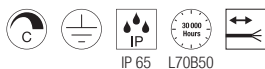
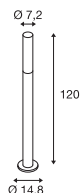

220-240V ~50/60Hz | 500mA  
Potência total: 6,3W  
Material: alumínio

- Extremidade do cabo aberta



Down 520lm | 3000K

Variante	Art. n.º	EUR
● Antracite	1000683	320,00



Artigo	Art. n.º	EUR
Caixa de ligação IP68, 3 polos		
● Preto	228730	23,00



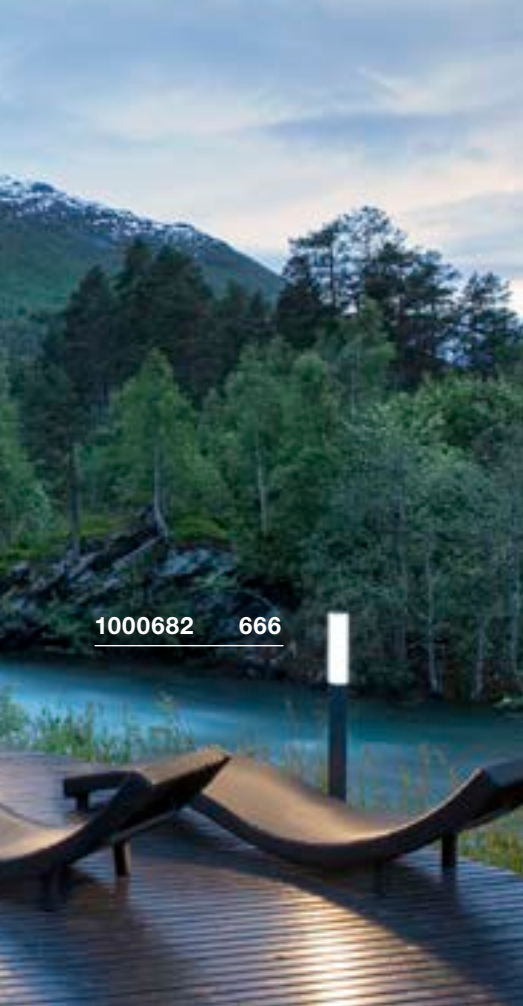

1000682 666

### TRUST 30 Pole

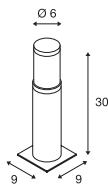

220-240V ~50/60Hz  
Potência total: 9W  
Material: aço inoxidável 316



Down 400lm | 3000K

Variante	Art. n.º	EUR
● Aço inoxidável	228100	259,00



Artigo	Art. n.º	EUR
Estaca		
● Preto	227922	53,00
Grelha em forma de anel		
● Aço inoxidável	228130	97,00
Caixa de ligação IP68, 3 polos		
● Preto	228730	23,00

228110 667

### TRUST 60 Pole

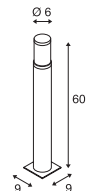

220-240V ~50/60Hz  
Potência total: 9W  
Material: aço inoxidável 316



Down 400lm | 3000K

Variante	Art. n.º	EUR
● Aço inoxidável	228110	332,00



Artigo	Art. n.º	EUR
Estaca		
● Preto	227922	53,00
Grelha em forma de anel		
● Aço inoxidável	228130	97,00
Caixa de ligação IP68, 3 polos		
● Preto	228730	23,00



**BIG NAILS 50**  
POLE, E27

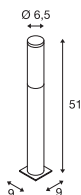

220-240V ~50/60Hz  
Material: aço inoxidável 304/  
polycarbonato (PC)



Casquilho: 1xE27 Máx. Ø: 4,5 cm C: 17 cm

Variante	Art. n.º	EUR
● Aço inoxidável	<b>229162</b>	<b>162,00</b>



LED E27 | 8W | 240°  
3000K | 880lm | EE=E  
8kWh/1000h



Art. N.º: **1005289** | **10,25 EUR**



Artigo	Art. n.º	EUR
Estaca		
● Preto	<b>227922</b>	<b>53,00</b>

**BIG NAILS 80**  
POLE, E27

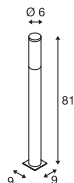

220-240V ~50/60Hz  
Material: aço inoxidável 304/  
polycarbonato (PC)



Casquilho: 1xE27 Máx. Ø: 4,5 cm C: 17 cm

Variante	Art. n.º	EUR
● Aço inoxidável	<b>229172</b>	<b>186,00</b>



| 13,5W | 240°  
3000K | 1520lm | EE=E  
14kWh/1000h



Art. N.º: **1005307** | **12,50 EUR**



Artigo	Art. n.º	EUR
Estaca		
● Preto	<b>227922</b>	<b>53,00</b>

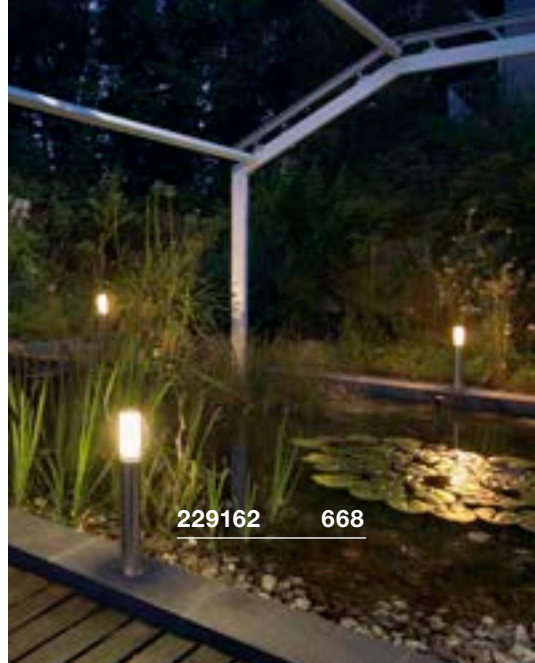

**229162** **668**



**229172** **668**



**1001490** **669**



**ROX ACRYL 30**  
Pole, E27

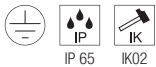
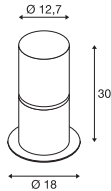

220-240V ~50/60Hz  
Material: aço inoxidável 304



Casquilho: 1xE27 Máx. Ø: 6 cm | C: 15 cm

Variante	Art. n.º	EUR
● Aço inoxidável	1001488	161,00



LED E27 | 8W | 240°  
3000K | 880lm | EE=E  
8kWh/1000h



Art. N.º: 1005289 | 10,25 EUR



Artigo	Art. n.º	EUR
Âncora de betão		
● Aço inoxidável	1001494	29,50
Estaca		
● Cinzento	231234	52,00
Caixa de conector em T		
● Preto	228726	36,00

**ROX ACRYL 60**  
Pole, E27

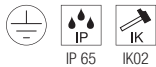
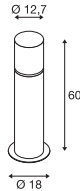

220-240V ~50/60Hz  
Material: aço inoxidável 304



Casquilho: 1xE27 Máx. Ø: 6 cm | C: 15 cm

Variante	Art. n.º	EUR
● Aço inoxidável	1001489	191,00



LED E27 | 8W | 240°  
3000K | 880lm | EE=E  
8kWh/1000h



Art. N.º: 1005289 | 10,25 EUR



Artigo	Art. n.º	EUR
Âncora de betão		
● Aço inoxidável	1001494	29,50
Estaca		
● Cinzento	231234	52,00
Caixa de conector em T		
● Preto	228726	36,00

**ROX ACRYL 90**  
Pole, E27

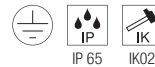
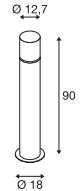

220-240V ~50/60Hz  
Material: aço inoxidável 304



Casquilho: 1xE27 Máx. Ø: 6 cm | C: 15 cm

Variante	Art. n.º	EUR
● Aço inoxidável	1001490	211,00



| 13,5W | 240°  
3000K | 1520lm | EE=E  
14kWh/1000h



Art. N.º: 1005307 | 12,50 EUR



Artigo	Art. n.º	EUR
Âncora de betão		
● Aço inoxidável	1001494	29,50
Estaca		
● Cinzento	231234	52,00
Caixa de conector em T		
● Preto	228726	36,00



230066 671



23006 671



### VAP SLIM 30

Pole, E27

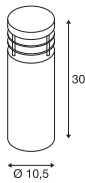

220-240V ~50/60Hz  
Material: aço inoxidável 304



Casquilho: 1xE27 Máx. Ø: 5,1 cm | C: 12,6 cm

Variante	Art. n.º	EUR
● Aço inoxidável	230063	171,00



LED E27 | 8W | 240°  
3000K | 880lm | EE=E  
8kWh/1000h



Art. N.º: 1005289 | 10,25 EUR



Artigo	Art. n.º	EUR
Âncora de betão		
● Aço inoxidável	230061	26,25
Estaca		
● Cinzento	230060	53,00

### VAP SLIM 60

Pole, E27



220-240V ~50/60Hz  
Material: aço inoxidável 304



Casquilho: 1xE27 Máx. Ø: 5,1 cm | C: 12,6 cm

Variante	Art. n.º	EUR
● Aço inoxidável	230066	191,00



LED E27 | 8W | 240°  
4000K | 920lm | EE=E  
8kWh/1000h



Art. N.º: 1005290 | 10,25 EUR



Artigo	Art. n.º	EUR
Âncora de betão		
● Aço inoxidável	230061	26,25
Estaca		
● Cinzento	230060	53,00

### VAP SLIM 90

Pole, E27



220-240V ~50/60Hz  
Material: aço inoxidável 304



Casquilho: 1xE27 Máx. Ø: 5,1 cm | C: 12,6 cm

Variante	Art. n.º	EUR
● Aço inoxidável	230069	222,00



LED E27 | 8W | 240°  
3000K | 880lm | EE=E  
8kWh/1000h



Art. N.º: 1005289 | 10,25 EUR



Artigo	Art. n.º	EUR
Âncora de betão		
● Aço inoxidável	230061	26,25
Estaca		
● Cinzento	230060	53,00

C-POL  
POLE, E27

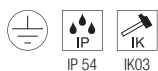
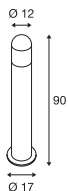

220-240V ~50/60Hz  
Material: alumínio /policarbonato (PC)



Casquilho: 1xE27 Máx. Ø: 5,2 cm | C: 17,3 cm

Variante	Art. n.º	EUR
● Antracite	231475	201,00



| 13,5W | 240°  
3000K | 1520lm | EE=E  
14kWh/1000h



Art. N.º: 1005307 | 12,50 EUR



Artigo	Art. n.º	EUR
Caixa de ligação IP68, 3 polos		
● Preto	228730	23,00

F-POL  
POLE, E27

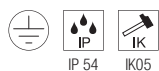
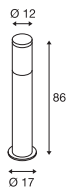

220-240V ~50/60Hz  
Material: alumínio /policarbonato (PC)



Casquilho: 1xE27 Máx. Ø: 5,1 cm | C: 14,8 cm

Variante	Art. n.º	EUR
● Antracite	231595	191,00



LED E27 | 8W | 240°  
3000K | 880lm | EE=E  
8kWh/1000h



Art. N.º: 1005289 | 10,25 EUR



Artigo	Art. n.º	EUR
Caixa de ligação IP68, 3 polos		
● Preto	228730	23,00

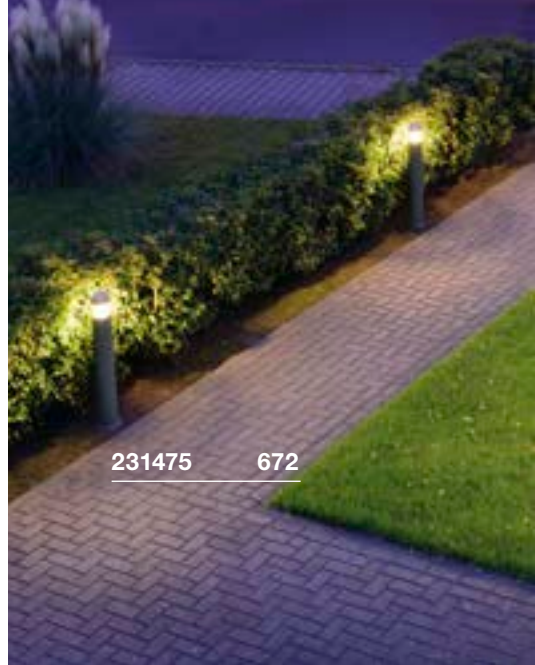

231475 672

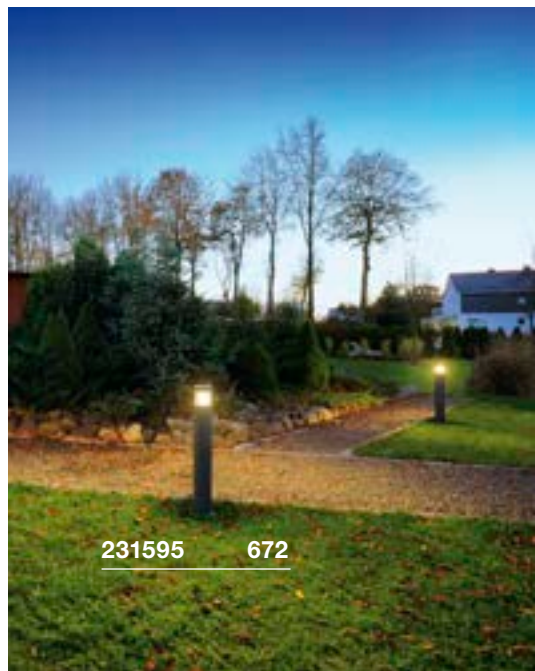

231595 672

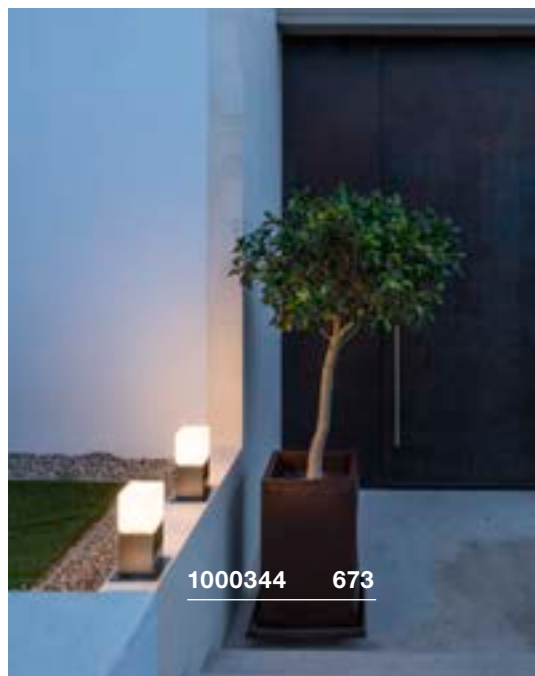

1000344 673





### SQUARE POLE 30

Pole, E27

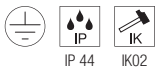
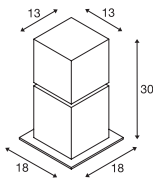

220-240V ~50/60Hz  
Material: aço inoxidável 304



Casquilho: 1xE27 Máx. Ø: 6 cm C: 15 cm

Variante	Art. n.º	EUR
● Aço inoxidável	1000344	232,00



LED E27 | 8W | 240°  
3000K | 880lm | EE=E  
8kWh/1000h



Art. N.º: 1005289 | 10,25 EUR



Artigo	Art. n.º	EUR
Âncora de betão		
● Aço inoxidável	1000343	54,00
Estaca		
● Cinzento	231234	52,00
Caixa de ligação IP68, 3 polos		
● Preto	228730	23,00

### SQUARE POLE 60

Pole, E27

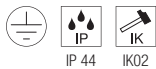
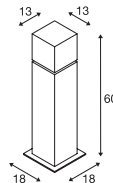

220-240V ~50/60Hz  
Material: aço inoxidável 304



Casquilho: 1xE27 Máx. Ø: 6 cm C: 15 cm

Variante	Art. n.º	EUR
● Aço inoxidável	1000345	292,00



| 13,5W | 240°  
3000K | 1520lm | EE=E  
14kWh/1000h



Art. N.º: 1005307 | 12,50 EUR



Artigo	Art. n.º	EUR
Âncora de betão		
● Aço inoxidável	1000343	54,00
Estaca		
● Cinzento	231234	52,00
Caixa de ligação IP68, 3 polos		
● Preto	228730	23,00

### SQUARE POLE 90

Pole, E27

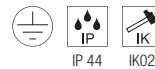
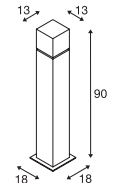

220-240V ~50/60Hz  
Material: aço inoxidável 304



Casquilho: 1xE27 Máx. Ø: 6 cm C: 15 cm

Variante	Art. n.º	EUR
● Aço inoxidável	1000346	343,00



| 13,5W | 240°  
3000K | 1520lm | EE=E  
14kWh/1000h



Art. N.º: 1005307 | 12,50 EUR



Artigo	Art. n.º	EUR
Âncora de betão		
● Aço inoxidável	1000343	54,00
Estaca		
● Cinzento	231234	52,00
Caixa de ligação IP68, 3 polos		
● Preto	228730	23,00



231455 675



### SLOTS 45 Pole

### SLOTS 65 Pole

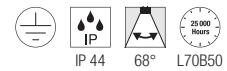
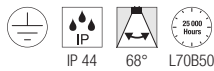
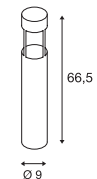
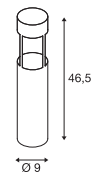

220-240V ~50/60Hz  
Potência total: 4,5W  
Material: alumínio

220-240V ~50/60Hz  
Potência total: 4,5W  
Material: alumínio

• Âncora de betão incluída.

• Âncora de betão incluída.



Down 200lm | 3000K

Down 200lm | 3000K

Variante	Art. n.º	EUR
● Antracite	231815	181,00
● Oxidado	231817	181,00

Variante	Art. n.º	EUR
● Antracite	231455	191,00
● Oxidado	231457	191,00

## H-POL 30 Pole

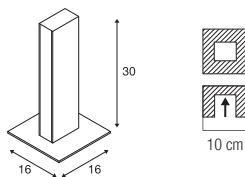

100-277V ~50/60Hz | 480mA  
Potência total: 9,7W  
Material: alumínio/plástico

- Este produto serve para encastrar no pavimento
- Está disponível uma caixa de instalação maior para instalação opcional no solo.  
Dimensões de montagem  
C: 14 cm L: 14 cm P: 16 cm



Down 350lm | 3000K

Variante	Art. n.º	EUR
● Antracite	232155	242,00



Artigo	Art. n.º	EUR
Caixa de instalação, 14x14 cm		
● Preto	232195	49,50

## H-POL 60 Pole

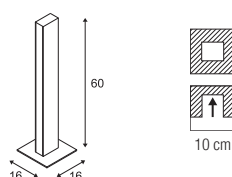

100-277V ~50/60Hz | 500mA  
Potência total: 18W  
Material: alumínio/plástico

- Este produto serve para encastrar no pavimento.
- Está disponível uma caixa de instalação maior para instalação opcional no solo.  
Dimensões de montagem  
C: 14 cm L: 14 cm P: 16 cm



Down 700lm | 3000K

Variante	Art. n.º	EUR
● Antracite	232165	353,00



Artigo	Art. n.º	EUR
Caixa de instalação, 14x14 cm		
● Preto	232195	49,50

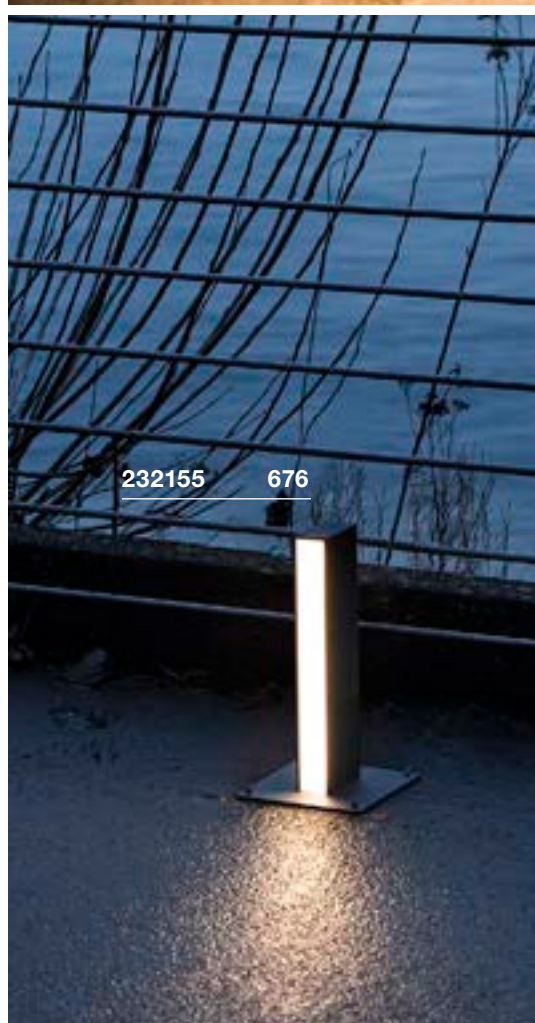

232155

676

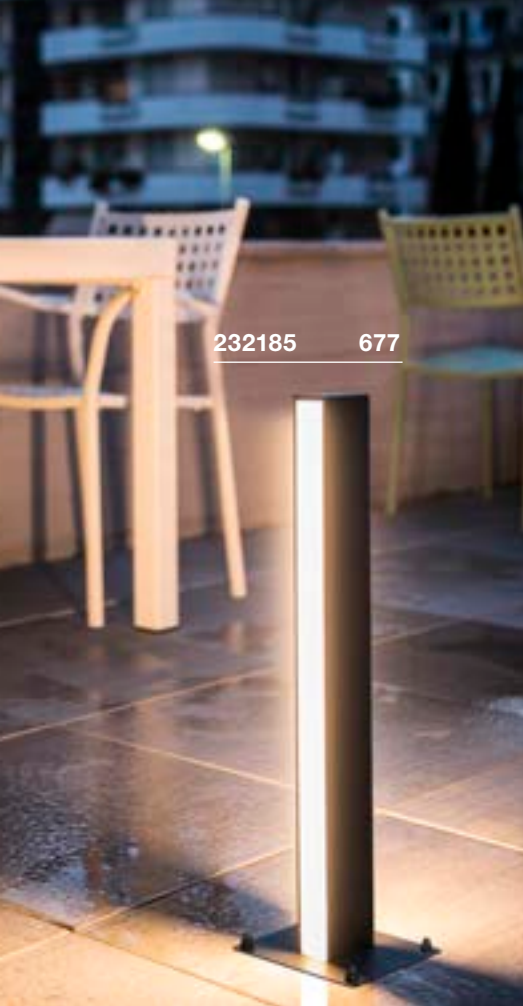

232185 677

### H-POL TWIN 30 Pole

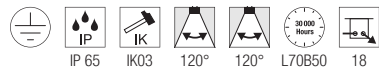
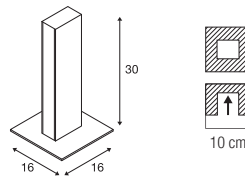

100-277V ~50/60Hz | 500mA  
Potência total: 18W  
Material: alumínio/plástico

- Este produto serve para encastrar no pavimento.
- Está disponível uma caixa de instalação maior para instalação opcional no solo.  
Dimensões de montagem  
C: 14 cm L: 14 cm P: 16 cm



Down 350lm | 3000K

Variante	Art. n.º	EUR
● Antracite	232175	333,00



Artigo	Art. n.º	EUR
Caixa de instalação, 14x14 cm		
● Preto	232195	49,50

### H-POL TWIN 60 Pole

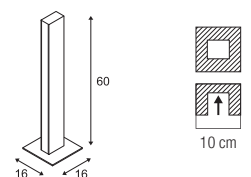

220-240V ~50/60Hz | 1000mA  
Potência total: 35W  
Material: alumínio/plástico

- Este produto serve para encastrar no pavimento.
- Está disponível uma caixa de instalação maior para instalação opcional no solo.  
Dimensões de montagem  
C: 14 cm L: 14 cm P: 16 cm



Down 700lm | 3000K

Variante	Art. n.º	EUR
● Antracite	232185	464,00



Artigo	Art. n.º	EUR
Caixa de instalação, 14x14 cm		
● Preto	232195	49,50



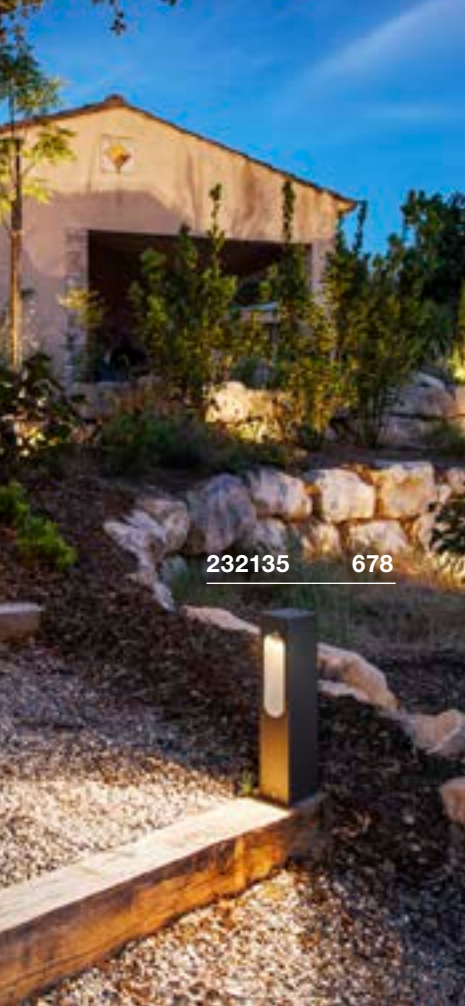

232135 678



232145 678

## SLOTBOX 40 Pole

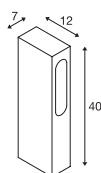

100-277V ~50/60Hz | 700mA  
Potência total: 8W  
Material: alumínio

- Extremidade do cabo aberta



Down 160lm | 3000K

Variante	Art. n.º	EUR
● Antracite	232135	201,00



Artigo	Art. n.º	EUR
Caixa de ligação IP68, 3 polos		
● Preto	228730	23,00

## SLOTBOX 70 Pole

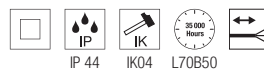
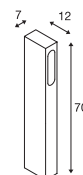

100-277V ~50/60Hz | 700mA  
Potência total: 8,7W  
Material: alumínio

- Extremidade do cabo aberta



Down 160lm | 3000K

Variante	Art. n.º	EUR
● Antracite	232145	242,00



Artigo	Art. n.º	EUR
Caixa de ligação IP68, 3 polos		
● Preto	228730	23,00

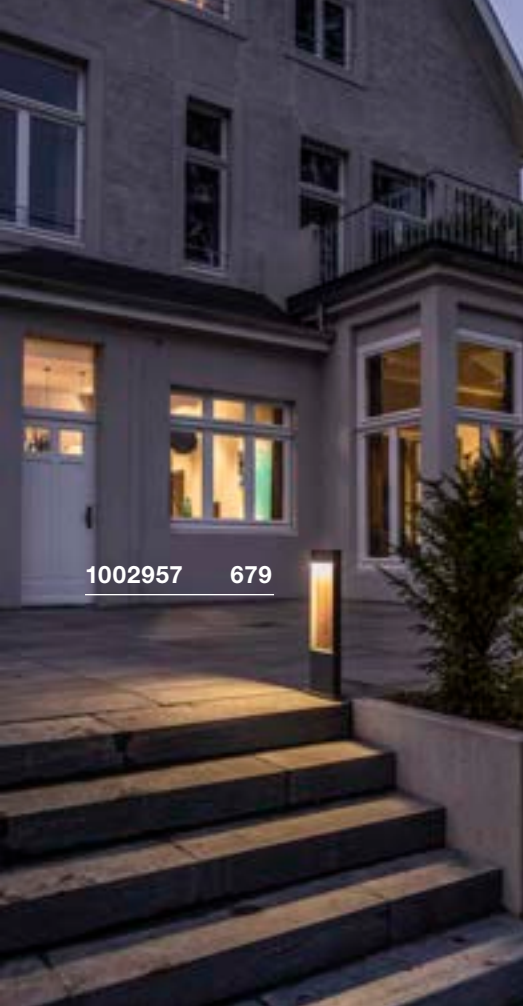

**1002957 679**



**1002958 679**

### FLATT 65 POLE

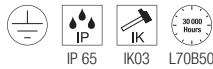
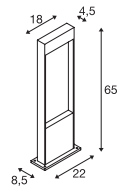
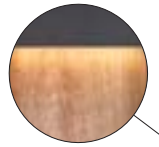

100-240V ~50/60Hz | 350mA  
Potência total: 10W  
Material: alumínio/alumínio

- A temperatura de cor da luz pode ser selecionada através do interruptor na estrutura, antes da instalação



Down 400lm | 3000K | 400lm | 4000K

Variante	Art. n.º	EUR
● Antracite	<b>1002956</b>	<b>248,00</b>
● castanho/antracite	<b>1002957</b>	<b>248,00</b>



Artigo	Art. n.º	EUR
Caixa de ligação IP68, 3 polos		
● Preto	<b>228730</b>	<b>23,00</b>

### FLATT 100 POLE

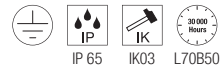
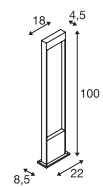

100-240V ~50/60Hz | 350mA  
Potência total: 10W  
Material: alumínio/alumínio

- A temperatura de cor da luz pode ser selecionada através do interruptor na estrutura, antes da instalação



Down 400lm | 3000K | 400lm | 4000K

Variante	Art. n.º	EUR
● Antracite	<b>1002958</b>	<b>302,00</b>
● castanho/antracite	<b>1002959</b>	<b>302,00</b>



Artigo	Art. n.º	EUR
Caixa de ligação IP68, 3 polos		
● Preto	<b>228730</b>	<b>23,00</b>

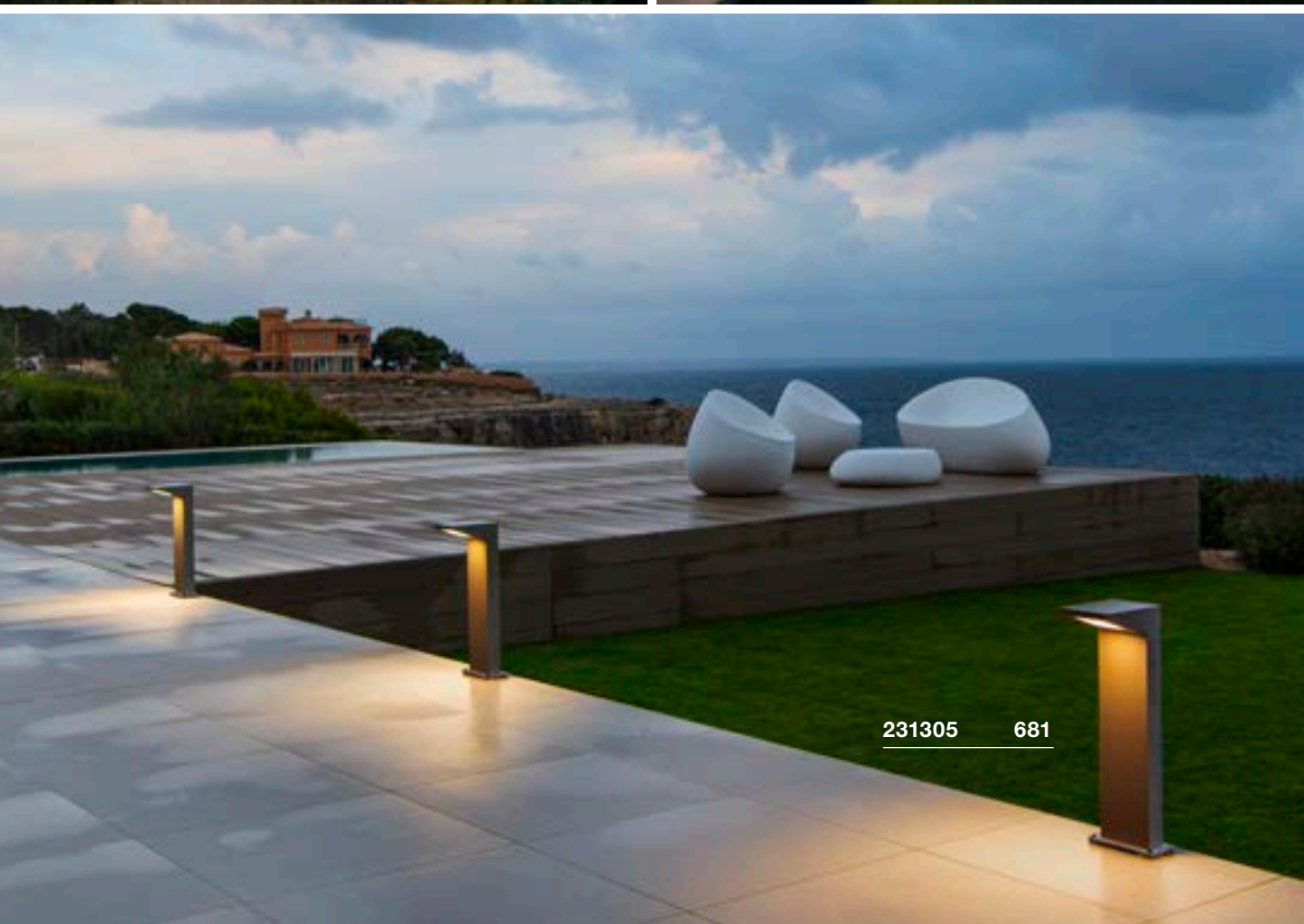





### ABRIDOR 60 Pole

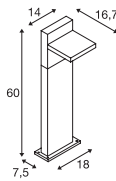

100-240V ~50/60Hz | 300mA  
Potência total: 12W  
Material: alumínio



Down 950lm | 3000K | 980lm | 4000K

Variante	Art. n.º	EUR
● Antracite	1002991	222,00

### ABRIDOR 100 Pole

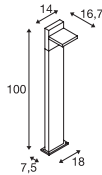

100-240V ~50/60Hz | 300mA  
Potência total: 12W  
Material: alumínio



Down 950lm | 3000K | 980lm | 4000K

Variante	Art. n.º	EUR
● Antracite	1002992	282,00

### IPERI 50 Pole

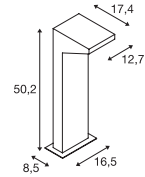

220-240V ~50/60Hz  
Potência total: 4,5W  
Material: alumínio/plástico



Down 400lm | 4000K

Variante	Art. n.º	EUR
● Antracite	231305	129,00



Artigo	Art. n.º	EUR
Estaca		
● Cinzento	231231	49,50

# QUADRASYL 75

Pole, TCR-TSE

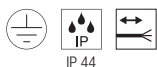
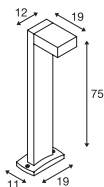

220-240V ~50/60Hz  
Material: alumínio

- Âncora de betão incluída.
- Extremidade do cabo aberta



Casquilho: 1xGX53 Máx. Ø: 7,5 cm C: 2,7 cm

Variante	Art. n.º	EUR
● Antracite	232295	166,00
● Cinzento	232294	166,00



LED GX53 | 6,1W | 120°  
3000K | 490lm | EE=G  
6kWh/1000h



Art. N.º: 1005271 | 11,50 EUR



Artigo	Art. n.º	EUR
Caixa de conector em T		
● Preto	228726	36,00



232295 682



1003001 683

### QUAD POLE Pole

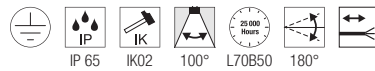
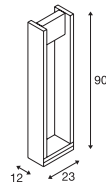

100-277V ~50/60Hz | 500mA  
Potência total: 18W  
Material: alumínio/vidro

- Extremidade do cabo aberta



Down 1550lm | 3000K

Variante	Art. n.º	EUR
● Antracite	1003001	370,00

### BOOKAT Pole

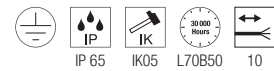
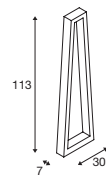

100-277V ~50/60Hz | 700mA  
Potência total: 15W  
Material: alumínio / policarbonato (PC)

- Caixa de ligação IP incl.
- Caixa de ligação IP



Down 1240lm | 3000K | 1300lm | 4000K

Variante	Art. n.º	EUR
● Antracite	1005441	403,00

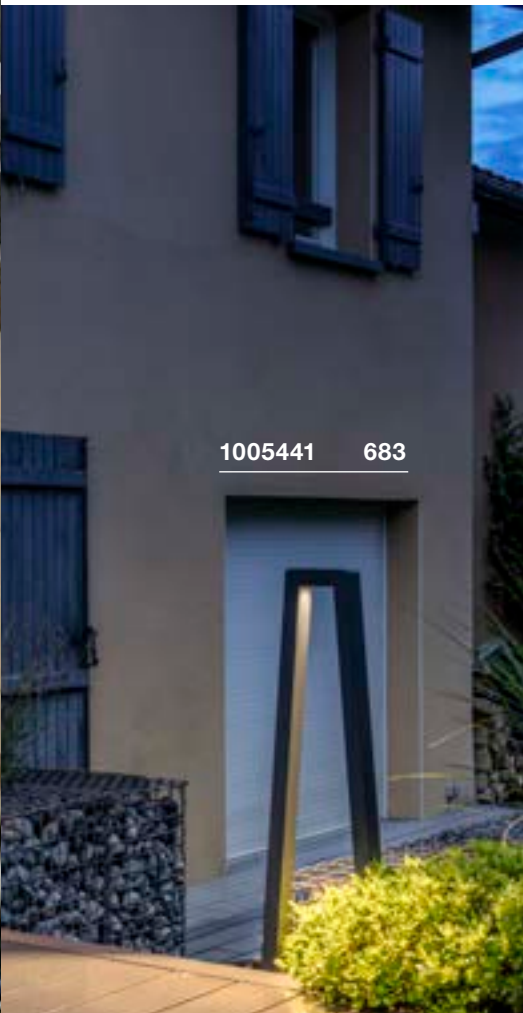

1005441 683



Artigo	Art. n.º	EUR
Caixa de ligação IP68, 3 polos		
● Preto	228730	23,00

RASCALI 45  
Pole

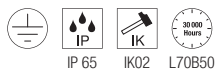
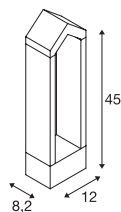

220-240V ~50/60Hz  
Potência total: 8W  
Material: alumínio



Down 360lm | 3000K

Variante	Art. n.º	EUR
● Antracite	1000799	184,00

RASCALI 65  
Pole

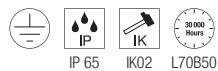
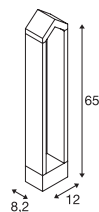

220-240V ~50/60Hz  
Potência total: 8W  
Material: alumínio



Down 360lm | 3000K

Variante	Art. n.º	EUR
● Antracite	1000801	207,00



1000799 684



1000801 684

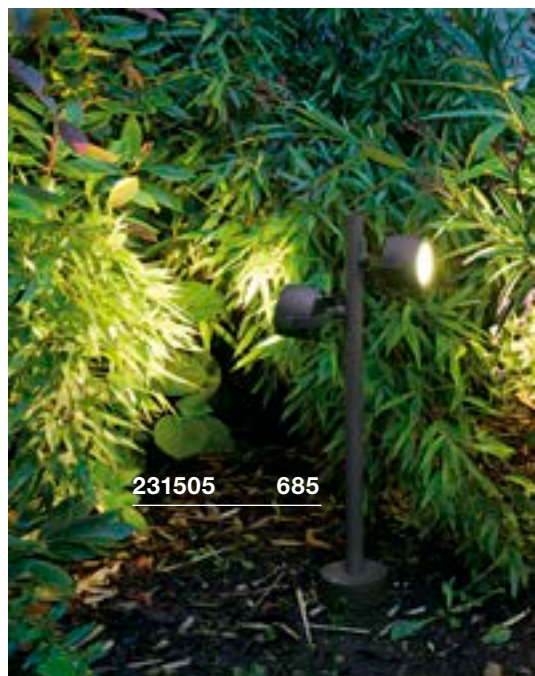

231505 685



**MYRA SPOT**  
Double, GU10

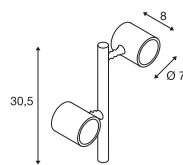

220-240V ~50/60Hz  
Material: alumínio

- A altura da luminária pode ser aumentada, no máximo, com 2 extensores.
- Extremidade do cabo aberta



Casquilho: 2xGU10 Máx. Ø: 5,1 cm | C: 5,7 cm

Variante	Art. n.º	EUR
● Antracite	233185	169,00



LED GU10 51mm | 6W | 38°  
2700K | 450lm | EE=F  
6kWh/1000h



Art. N.º: 1005075 | 7,50 EUR



Artigo	Art. n.º	EUR
Âncora de betão		
● Prateado	228712	64,00
Jogo de parafusos		
● Aço inoxidável	228752	6,50
Casquilho		
● Antracite	233145	26,75
Extensor de 30 cm		
● Antracite	233165	26,75

**SITRA 360**  
Pole, TCR-TSE

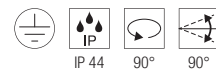
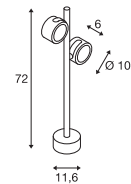

220-240V ~50/60Hz  
Material: alumínio/vidro



Casquilho: 2xGX53 Máx. Ø: 7,5 cm | C: 3,5 cm

Variante	Art. n.º	EUR
● Antracite	231505	162,00



LED GX53 | 6,1W | 120°  
3000K | 490lm | EE=G  
6kWh/1000h



Art. N.º: 1005271 | 11,50 EUR



Artigo	Art. n.º	EUR
Estaca		
● Cinzento	230060	53,00





1001962 697



**LED**  
SYNA PLANT | 689



**LED**  
SYNA GARDEN | 689



**LED**  
SYNA | 689



**LED**  
FLOODI S | 691



**LED**  
FLOODI M | 691



**LED**  
FLOODI L | 691



**LED**  
GALEN 60 | 692



**LED**  
GALEN 120 | 692



**LED**  
FLAC BEAM® | 693



**S-CCKET**  
SAMRINA | 693



**S-CCKET**  
NAUTILUS 10 | 694



**S-CCKET**  
BIG NAUTILUS | 694



**S-CCKET**  
NAUTILUS 10 | 695



**LED**  
NAUTILUS 10 | 696



**S-CCKET**  
NAUTILUS | 697



**S-CCKET**  
NAUTILUS 10  
SPOT | 697



**LED**  
NAUTILUS 10  
SPOT LED | 697



**LED**  
DASAR®  
PROJECTOR | 698



**LED**  
DASAR® 920 | 698



**LED**  
HELIA SPOT S | 699



**LED**  
HELIA SPOT L | 699



**S-CCKET**  
THEO BRACKET | 701



**LED**  
LED SPIKE | 701



**S-CCKET**  
SITRA 360 SPIKE | 703



**S-CCKET**  
SITRA 360 SPIKE | 703



227505 689

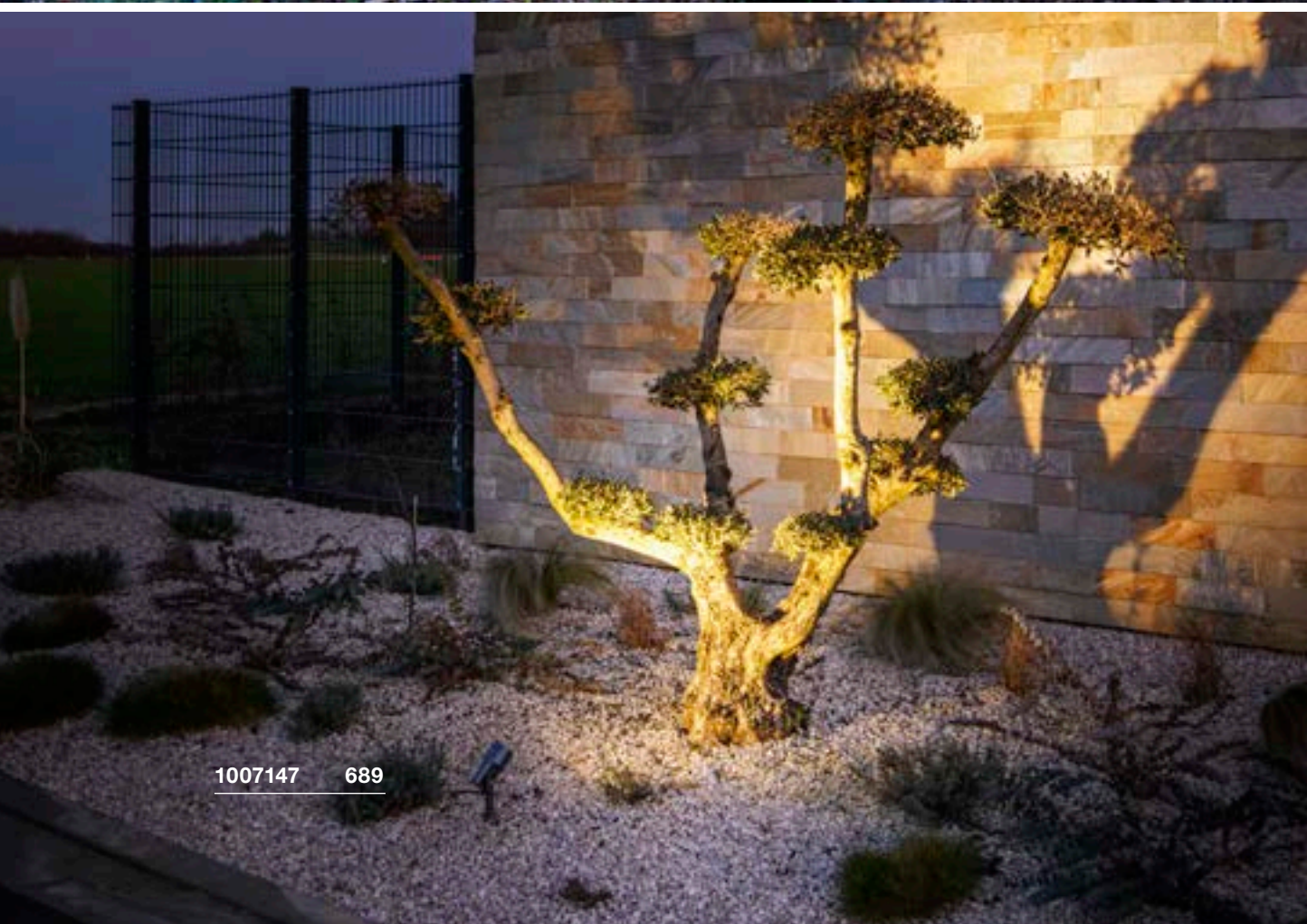

1007147 689





### SYNA PLANT SP

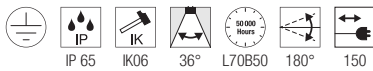
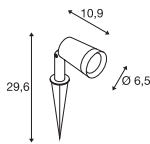

220-240V ~50/60Hz | 250mA  
Potência total: 6W  
Material: alumínio

- Ficha de segurança IP44



Down 540lm | 3000K

Variante	Art. n.º	EUR
● Preto	1007146 ●	65,00

### SYNA GARDEN SP

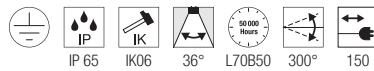
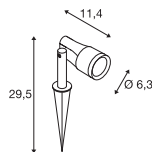

220-240V ~50/60Hz | 250mA  
Potência total: 6W  
Material: alumínio

- Ficha de segurança IP44



Down 540lm | 3000K

Variante	Art. n.º	EUR
● Preto	1007147 ●	69,00

### SYNA SP

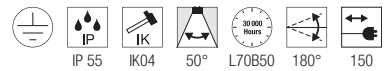
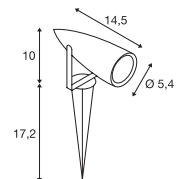

220-240V ~50/60Hz  
Potência total: 9W  
Material: alumínio/acrílico

- Ficha de segurança IP44



Down 470lm | 3000K

Variante	Art. n.º	EUR
● Antracite	227505	80,00



1006193 691



### FLOODI S SP

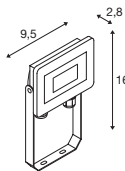

220-240V ~50/60Hz  
Potência total: 9,3W  
Material: alumínio



Down 1040lm | 3000K

Variante	Art. n.º	EUR
● Antracite	1006191	30,00



Artigo	Art. n.º	EUR
Sensor		
● Preto	1006326	29,00

### FLOODI M SP

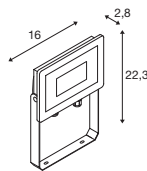

220-240V ~50/60Hz  
Potência total: 30W  
Material: alumínio



Down 2980lm | 3000K

Variante	Art. n.º	EUR
● Antracite	1006192	45,00



Artigo	Art. n.º	EUR
Sensor		
● Preto	1006326	29,00

### FLOODI L SP

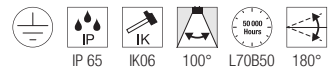
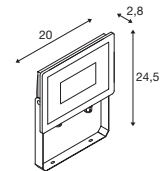

220-240V ~50/60Hz  
Potência total: 48W  
Material: alumínio



Down 5150lm | 3000K

Variante	Art. n.º	EUR
● Antracite	1006193	60,00



Artigo	Art. n.º	EUR
Sensor		
● Preto	1006326	29,00

## GALEN 60 SP

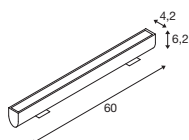

220-240V ~50/60Hz | 450mA  
Potência total: 18W  
Material: alumínio/vidro



Down 1570lm | 3000K | 1570lm | 4000K

Variante	Art. n.º	EUR
● Antracite	1003447	229,00



Artigo	Art. n.º	EUR
Extremidade do cabo aberta com 5m		
● Preto	231960	28,00
Cabo de ligação 1,0 m		
● Preto	231961	19,00

## GALEN 120 SP

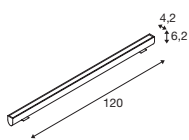

220-240V ~50/60Hz | 900mA  
Potência total: 34W  
Material: alumínio/vidro



Down 3000lm | 3000K | 3100lm | 4000K

Variante	Art. n.º	EUR
● Antracite	1003448	339,00



Artigo	Art. n.º	EUR
Extremidade do cabo aberta com 5m		
● Preto	231960	28,00
Cabo de ligação 1,0 m		
● Preto	231961	19,00





## FLAC BEAM® SP

## SAMRINA SP, single, GU10

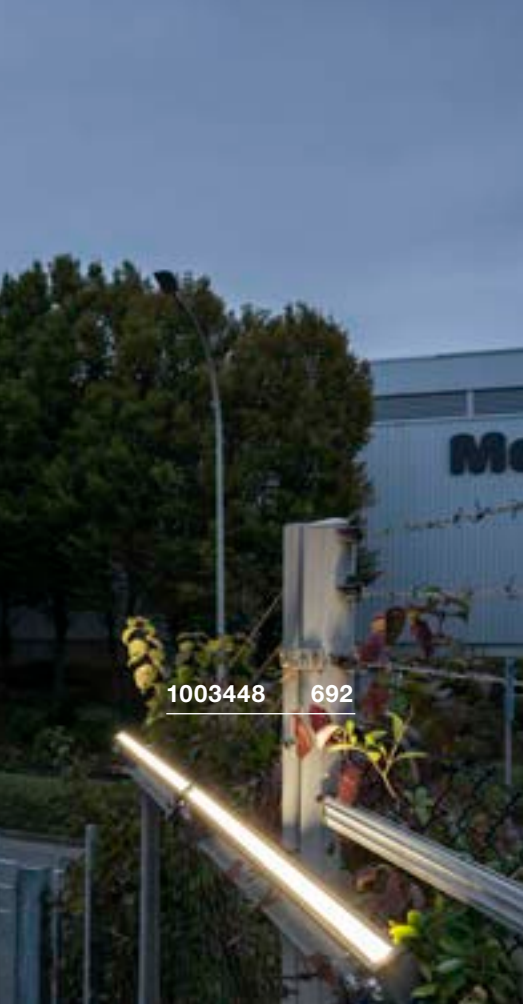

1003448 692

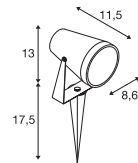
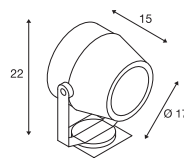

220-240V ~50/60Hz  
Potência total: 27W  
Material: alumínio/vidro

220-240V ~50/60Hz  
Material: plástico/vidro

- Ficha de segurança IP44

- Contém material reciclado
- Ficha de segurança IP44



Down 1600lm | 3000K



Casquilho: GU10 Máx. Ø: 6 cm | C: 6 cm

Variante	Art. n.º	EUR
● Cinzento	231072	492,00

Variante	Art. n.º	EUR
● Preto	1004757	45,50



LED GU10 51mm | 6W | 38°  
2700K | 450lm | EE=F  
6kWh/1000h



Art. N.º: 1005077 | 7,50 EUR



**NAUTILUS 10**  
SP, Redondo, QPAR51

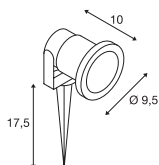

220-240V ~50/60Hz  
Material: alumínio

- Ficha de segurança IP44



Casquilho: 1xGU10 Máx. C: 5,7 cm

Variante	Art. n.º	EUR
● Cinzento	227418	27,00



LED GU10 51mm | 6W | 38°  
2700K | 450lm | EE=F  
6kWh/1000h



Art. N.º: 1005077 | 7,50 EUR

**BIG NAUTILUS**  
SP, Redondo, QPAR51

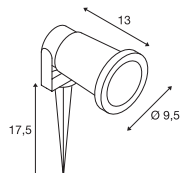

220-240V ~50/60Hz  
Material: alumínio

- Ficha de segurança IP44



Casquilho: GU10 Máx. Ø: 5,1 cm | C: 8,3 cm

Variante	Art. n.º	EUR
● Preto	227410	30,00
● Oxidado	1001964	30,00
● Verde	1001965	30,00



LED GU10 51mm | 6W | 38°  
2700K | 450lm | EE=F  
6kWh/1000h



Art. N.º: 1005077 | 7,50 EUR

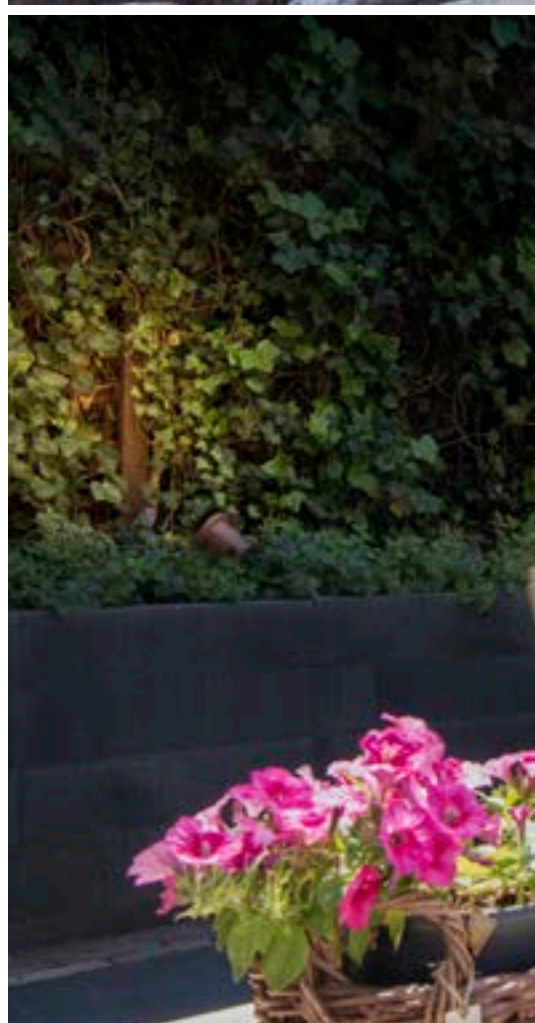
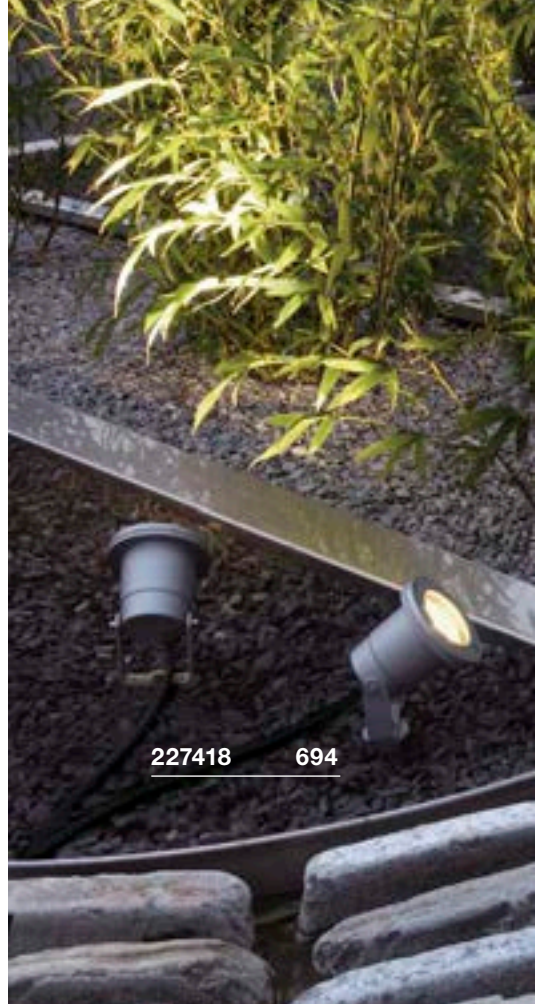



## NAUTILUS 10

SP, Redondo, QPAR51

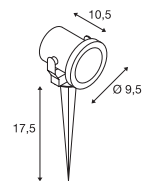

220-240V ~50/60Hz  
Material: aço inoxidável 316

- Ficha de segurança IP44

**SOCKET INSIDE**  <25 W

Casquilho: 1xGU10 Máx. Ø: 5,1 cm | C: 5,7 cm

Variante	Art. n.º	EUR
● Aço inoxidável	229740	99,00



LED GU10 51mm | 6W | 38°  
2700K | 450lm | EE=F  
6kWh/1000h



Art. N.º: 1005077 | 7,50 EUR

1001964 694



231035 696

## NAUTILUS 10 SP, Quadrado

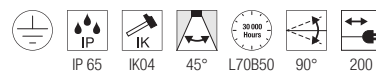
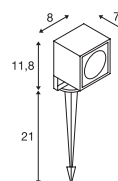

100-277V ~50/60Hz | 700mA

Potência total: 8,5W

Material: alumínio/vidro

- Ficha de segurança IP44

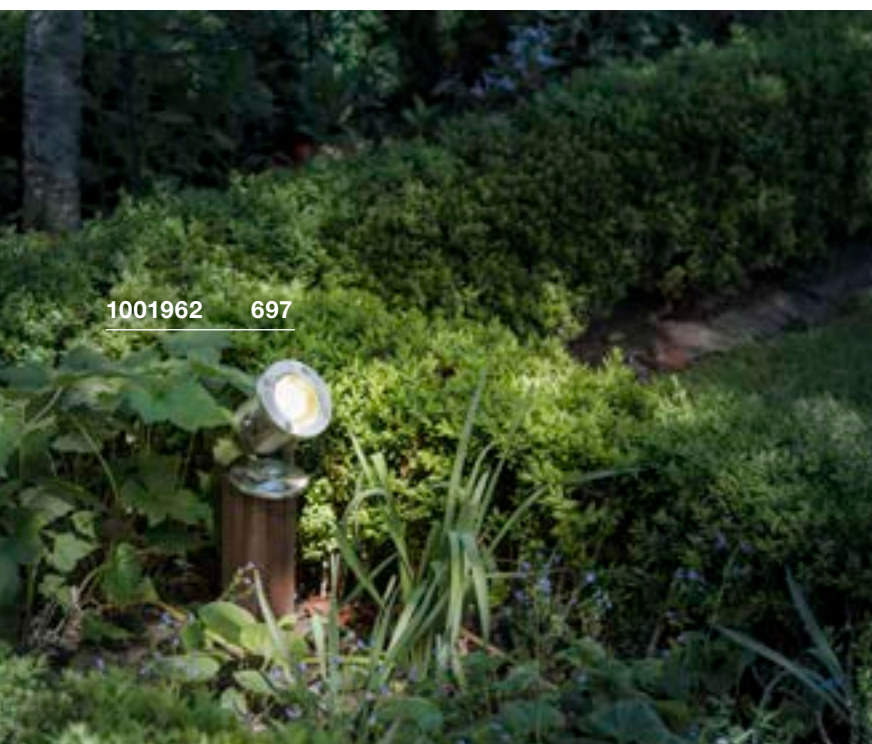

1001962 697



Down

660lm | 3000K

Variante	Art. n.º	EUR
● Antracite	231035	145,00





### NAUTILUS SP, QR-C51

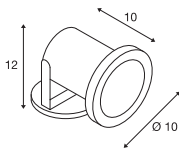

12V ~50Hz  
Material: aço inoxidável 304/vidro

- Extremidade do cabo aberta



Casquilho: 1xGX5.3

Variante	Art. n.º	EUR
● Aço inoxidável	229090	89,00



LED GU5.3 | 5,8W | 36°  
2700K | 450lm | EE=G  
6kWh/1000h

Art. N.º: 1001574 | 35,00 EUR

### NAUTILUS 10 SPOT SP, QPAR51

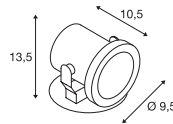

220-240V ~50/60Hz  
Material: aço inoxidável 316

- Extremidade do cabo aberta



Casquilho: 1xGU10 Máx. Ø: 5,1 cm | C: 6 cm

Variante	Art. n.º	EUR
● Aço inoxidável	229741	99,00



LED GU10 51mm | 6W | 38°  
2700K | 450lm | EE=F  
6kWh/1000h

Art. N.º: 1005077 | 7,50 EUR



Artigo	Art. n.º	EUR
Caixa de ligação IP68, 3 polos		
● Preto	228730	23,00

### NAUTILUS 10 SPOT LED SP

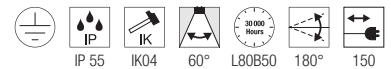
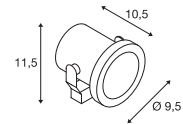

220-240V ~50/60Hz  
Potência total: 9W  
Material: aço inoxidável 316

- Ficha de segurança IP44



Down 520lm | 3000K

Variante	Art. n.º	EUR
● Aço inoxidável	1001962	114,00



Artigo	Art. n.º	EUR
Estaca em plástico		
● Preto	900011	4,00
Placa de montagem		
● Aço inoxidável	1001963	9,05

DASAR® PROJECTOR  
SP, 12/24V

DASAR® 920  
SP, 230V

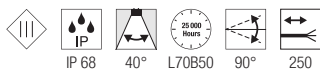
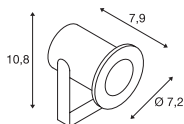
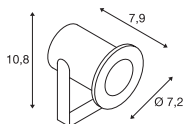

12-24 V DC  
Potência total: 6,5W  
Material: aço inoxidável 316/vidro

220-240V ~50/60Hz | 400mA  
Potência total: 4,6W  
Material: aço inoxidável 316/vidro

- Extremidade do cabo aberta

- Ficha de segurança IP44



Down 520lm | 3000K

Variante	Art. n.º	EUR
● Aço inoxidável	233570	242,00



Artigo	Art. n.º	EUR
Estaca em aço inoxidável 316		
● Aço inoxidável	233580	19,00
Estaca em plástico		
● Preto	900011	4,00
Fonte de alimentação LED 15W   12V		
○ Branco	1005444	29,50
Fonte de alimentação LED 15W   24 V		
○ Branco	1005445	29,50
Placa de montagem em aço inoxidável 316		
● Aço inoxidável	233582	26,00



Down 300lm | 3000K

Variante	Art. n.º	EUR
● Aço inoxidável	233571	302,00



Artigo	Art. n.º	EUR
Estaca em aço inoxidável 316		
● Aço inoxidável	233580	19,00
Estaca em plástico		
● Preto	900011	4,00
Placa de montagem em aço inoxidável 316		
● Aço inoxidável	233582	26,00

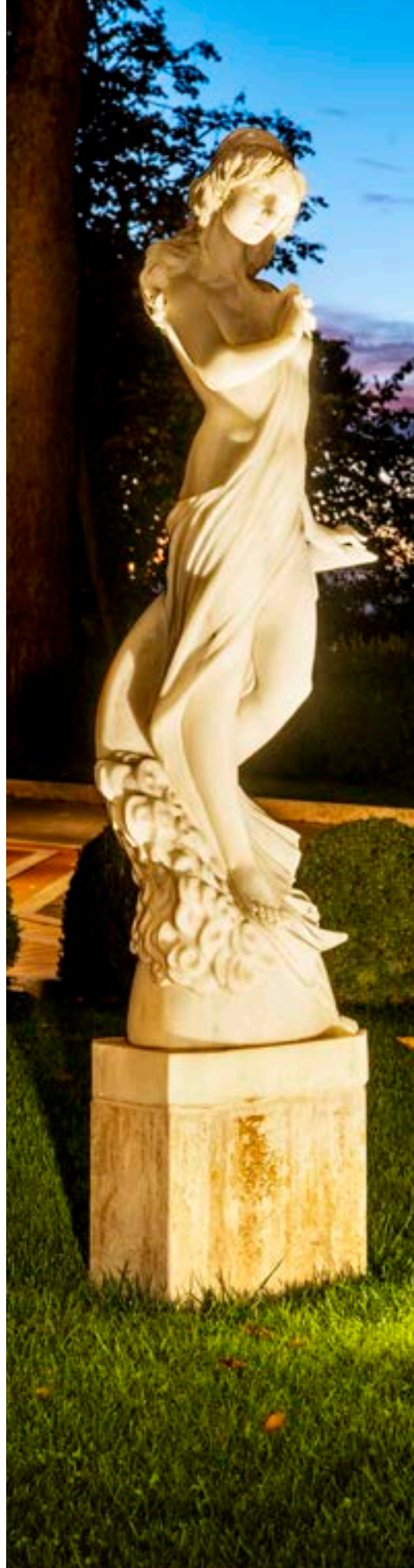



### HELIA SPOT S SP, single

### HELIA SPOT L SP, single, PHASE

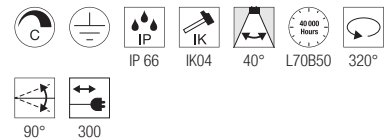
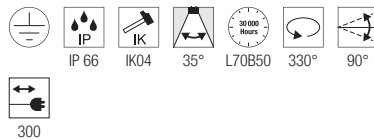
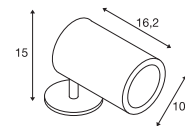
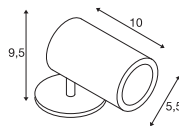

220-240V ~50/60Hz | 500mA  
Potência total: 6,5W  
Material: alumínio

220-240V ~50/60Hz | 700mA  
Potência total: 15W  
Material: alumínio/vidro

- Ficha de segurança IP44

- Ficha de segurança IP44



Down 440lm | 3000K

Down 1340lm | 3000K

Variante	Art. n.º	EUR
● Antracite	1000735	176,00

Variante	Art. n.º	EUR
● Antracite	228555	226,00



Artigo	Art. n.º	EUR
Estaca		
● Aço inoxidável	1000736	21,75

Artigo	Art. n.º	EUR
Estaca		
● Aço inoxidável	228560	26,50

233570 698



1004652 701

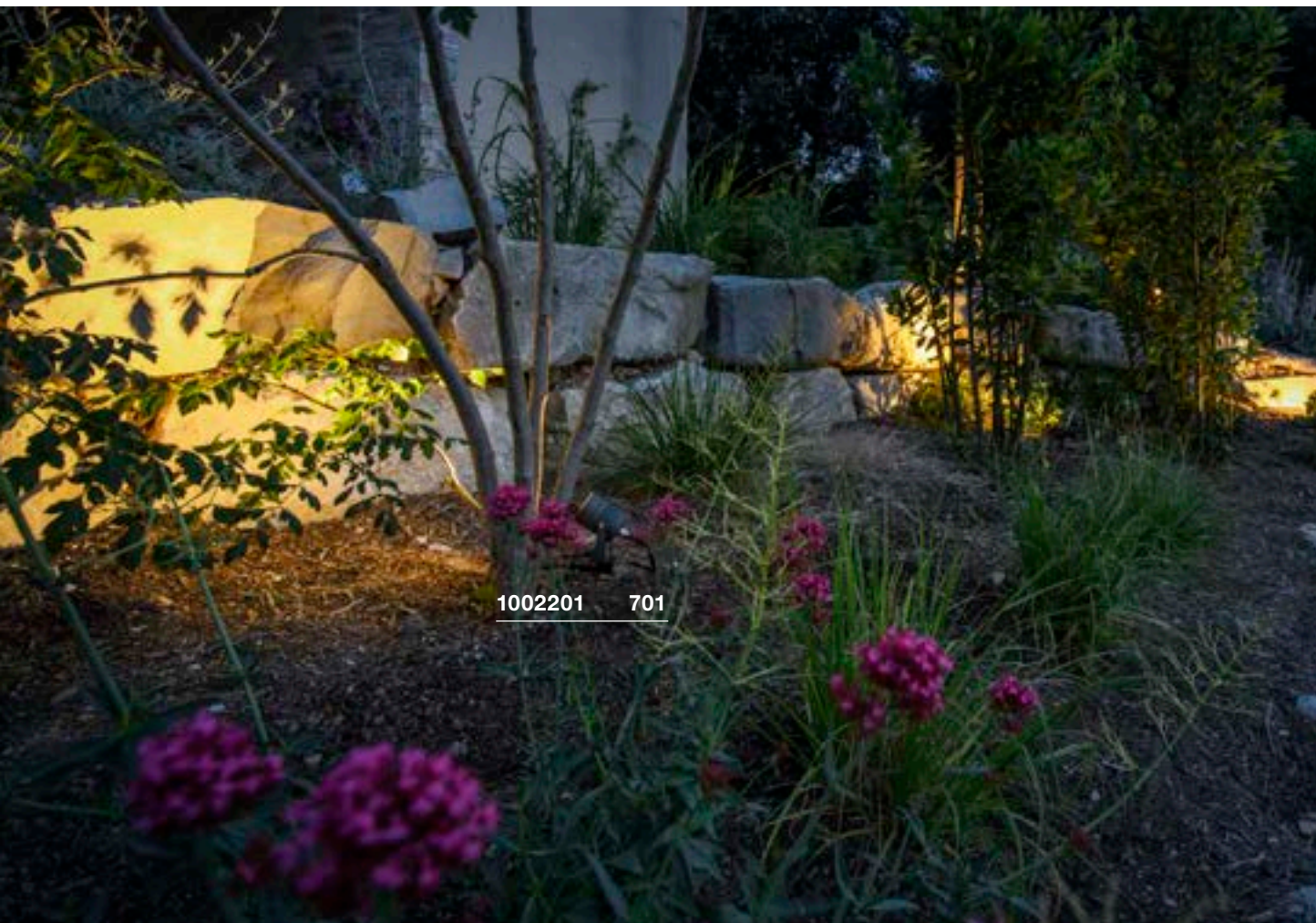

1002201 701



## THEO BRACKET SP

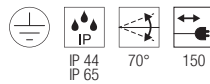
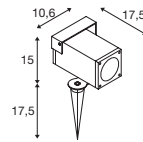

220-240V ~50/60Hz  
Material: alumínio/vidro

- Ficha de segurança IP44



Casquilho: 1xGU10 Máx. Ø: 5,1 cm | C: 5,7 cm

Variante	Art. n.º	EUR
● Antracite	1004652	66,00



LED GU10 51mm | 6W | 38°  
2700K | 450lm | EE=F  
6kWh/1000h

Art. N.º: 1005077 | 7,50 EUR



## LED SPIKE SP

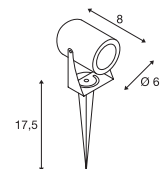

100-240V ~50/60Hz | 240mA  
Potência total: 6W  
Material: alumínio/vidro

- Ficha de segurança IP44



Down 400lm | 3000K

Variante	Art. n.º	EUR
● Antracite	1002201	70,00
● Oxidado	1002203	70,00

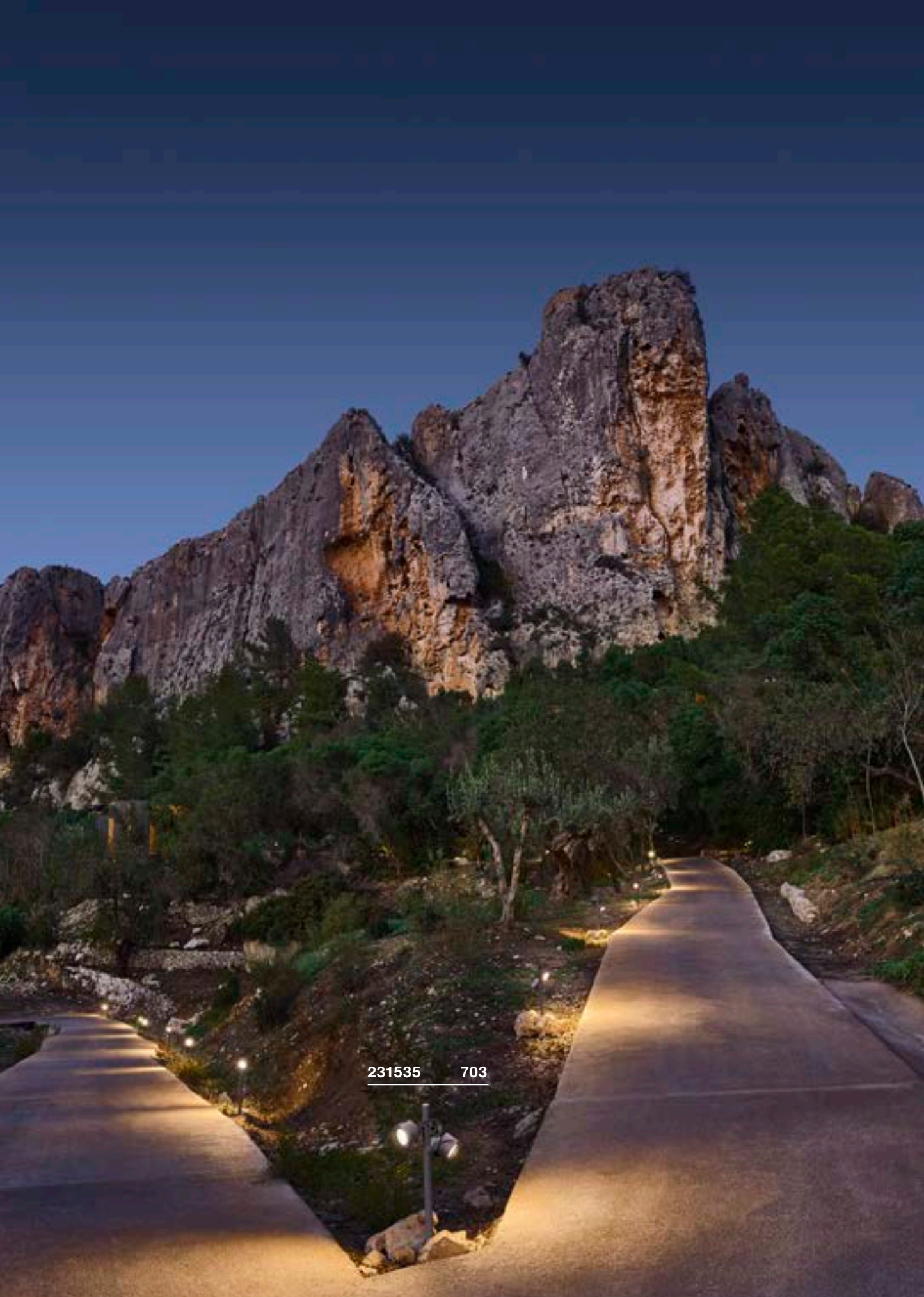

231535 703



SITRA 360 SPIKE  
SP, single, TCR-TSE

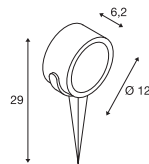

220-240V ~50/60Hz  
Material: alumínio/vidro

- Ficha de segurança IP44

**SOCKET INSIDE** <9 W

Casquilho: 1xGX53 Máx. Ø: 7,5 cm | C: 3,5 cm

Variante	Art. n.º	EUR
● Antracite	231525	64,00



LED GX53 | 6,1W | 120°  
3000K | 490lm | EE=G  
6kWh/1000h



Art. N.º: 1005271 | 11,50 EUR

SITRA 360 SPIKE  
SP, double, TCR-TSE

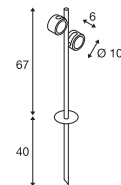

220-240V ~50/60Hz  
Material: alumínio/vidro

- Ficha de segurança IP44

**SOCKET INSIDE** <9 W

Casquilho: 2xGX53 Máx. Ø: 7,5 cm | C: 3,5 cm

Variante	Art. n.º	EUR
● Antracite	231535	191,00



LED GX53 | 6,1W | 120°  
3000K | 490lm | EE=G  
6kWh/1000h



Art. N.º: 1005271 | 11,50 EUR



234515

735





NEW

**SCKET**

PHOTONI | 709



NEW

**LED**

LID II | 711



NEW

**LED**

LID II | 711



NEW

**LED**

LID I | 713



NEW

**LED**

LID I | 713



NEW

**LED**

I-RING | 714



NEW

**LED**

OVAL 14 | 715



NEW

**LED**

OVAL 18 | 715



NEW

**LED**

CONCRETO M | 717



NEW

**LED**

CONCRETO L | 717



**LED**

VANO WING | 719



**LED**

VANO WING | 719



**LED**

MANA BASE | 720



NEW

RUSTY® MANA | 720



NEW

RUSTY® MANA | 720



**LED**

MANA OUT | 721



NEW

**LED**

MANA OUT | 721



NEW

**LED**

ENOLA OCULUS | 723



NEW

**LED**

ENOLA OCULUS | 723



**LED**

ENOLA OCULUS S | 725



**LED**

ENOLA OCULUS M | 725



**LED**

ENOLA ROUND L | 725



**LED**

ENOLA ROUND S UP/DOWN | 727



**LED**

ENOLA ROUND M UP/DOWN | 727



**LED**

ENOLA ROUND L UP/DOWN | 727



**LED**

ENOLA SQUARE S | 729



**LED**

ENOLA SQUARE M | 729



**LED**

ENOLA SQUARE L | 729



**LED**

ENOLA SQUARE S UP/DOWN | 730



**LED**

ENOLA SQUARE M UP/DOWN | 730



**LED**

ENOLA SQUARE L UP/DOWN | 730



**SCKET**

THEO UP/DOWN | 735



**LED**

BIG THEO BEAM UP/ FLOOD DOWN | 735



**SCKET**

BIG THEO UP/DOWN | 735



**LED**

BIG THEO FLOOD UP/DOWN | 736



**SCKET**

THEO | 736



**SCKET**

BIG THEO | 737



**LED**

BIG THEO | 737



**LED**

SITRA S | 739



**LED**

SITRA S | 739



**LED**

SITRA M | 741



**LED**

SITRA L | 741

NEW



**SCKET**  
SITRA CUBE | 741



**SCKET**  
GRAFIT | 742



**SCKET**  
GRAFIT | 742



**SCKET**  
GRAFIT | 743



**SCKET**  
GRAFIT | 743



**LED**  
QUADRULO | 744



**SCKET**  
QUADRULO  
SENSOR | 745



**SCKET**  
QUADRULO | 745



**SCKET**  
MERIDIAN | 746



**SCKET**  
MERIDIAN BOX | 746



**SCKET**  
MERIDIAN BOX  
SENSOR | 747



**SCKET**  
MERIDIAN BOX | 747



**LED**  
ESKINA FRAME | 749



**LED**  
ESKINA FRAME | 749



**LED**  
ESKINA FRAME | 749



**LED**  
BOOKAT | 751



**LED**  
BIG QUAD | 752



**LED**  
QUAD | 752



**LED**  
QUAD  
UP/DOWN 15 | 753



**LED**  
BIG QUAD  
UP/DOWN | 755



**LED**  
BIG QUAD | 755



**LED**  
RUSTY®  
UP/DOWN | 756



**LED**  
RUSTY®  
UP/DOWN | 756



**LED**  
OVALISK  
SENSOR | 757



**LED**  
OVALISK | 757



**LED**  
PEMA® | 758



**LED**  
PEMA® | 759



**LED**  
PEMA® | 759



**SCKET**  
PEMA® | 759



**LED**  
FLATT SENSOR | 760



**LED**  
FLATT | 760



**SCKET**  
ASTINA | 761



**SCKET**  
ASTINA STEEL | 761



**LED**  
ANGOLUX  
SENSOR | 762



**LED**  
ANGOLUX | 762



**LED**  
VILUA S | 763



**LED**  
VILUA L | 763



**LED**  
VILUA | 763



**SCKET**  
MYRA  
UP/DOWN | 764



**LED**  
SITRA  
UP/DOWN | 765



**SCKET**  
SITRA  
UP/DOWN | 765



**SCKET**  
ROX | 767



**SCKET**  
ROX UP/DOWN | 767



**LED**  
DELWA | 767



**LED**  
SLOTS | 768



**SCKET**  
WALLYX | 768



**LED**  
DOWNUNDER  
OUT | 769



**LED**  
DOWNUNDER  
OUT | 769



**LED**  
ABRIDOR  
SENSOR | 770



**LED**  
ABRIDOR | 770



**LED**  
ORDI SENSOR | 771



**LED**  
ORDI | 771



**SCKET**  
BOX-L | 773



**LED**  
BOX-L | 773



**SCKET**  
BOX UP/DOWN | 775



**LED**  
LOGS | 775



**LED**  
OUT-BEAM UP /  
FLOOD DOWN | 775



**LED**  
L-LINE OUT | 775



**SCKET**  
PHOTONIA | 777



**SCKET**  
MOLAT | 777



**SCKET**  
GLOO PURE | 777



**SCKET**  
F-POL | 778



**SCKET**  
SQUARE | 779



**SCKET**  
KERAS ELT | 779



**SCKET**  
SITRA | 779



**LED**  
RASCALI | 780



**LED**  
IPERI | 780



**SCKET**  
QUADRASYL | 781



**SCKET**  
SQUARE TURN | 781



**LED**  
TODAY PRO | 783



**LED**  
ESKINA D | 783



**SCKET**  
MYRA DISPLAY | 783



**LED**  
LED SPOT | 785



**SCKET**  
NAUTILUS | 785



**SCKET**  
MYRA | 785

1007585 709





## PHOTONI WL, E27

NEW

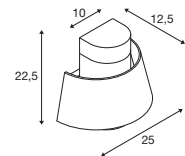

IP55

IK08

220-240V ~50/60Hz  
Material: alumínio

- Resistente a ambientes marítimos

**SOCKET**  
**INSIDE**

13  
W

Casquilho: 1xE27

Máx. Ø: 6 cm

C: 11,6 cm

Variante	Art. n.º	EUR
● Preto	1007585	99,00
● Oxidado	1007581	99,00



LED E27 | 8W | 240°  
3000K | 880lm | EE=E  
8kWh/1000h



Art. N.º: 1005289 | 10,25 EUR



1007281 711



LID II  
WL

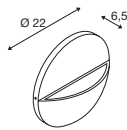

220-240V ~50/60Hz | 350mA  
Potência total: 15W  
Material: alumínio



Down 800lm | 2700K | 800lm | 3000K

Variante	Art. n.º	EUR
● Antracite	1007282	● 109,00

LID II  
WL, up/down

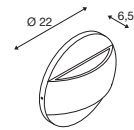

220-240V ~50/60Hz | 700mA  
Potência total: 28W  
Material: alumínio



Up 750lm | 2700K | 750lm | 3000K  
Down 750lm | 2700K | 750lm | 3000K

Variante	Art. n.º	EUR
● Antracite	1007281	● 129,00

1007667 713







### LID I WL, single

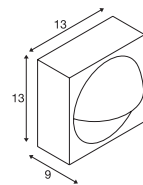

220-240V ~50/60Hz | 350mA  
Potência total: 15W  
Material: alumínio



Down 900lm | 2700K | 1050lm | 3000K

Variante	Art. n.º	EUR
● Antracite	1007667	● 144,00

### LID I WL, double

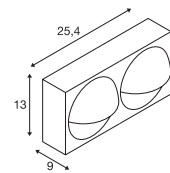

220-240V ~50/60Hz | 700mA  
Potência total: 29W  
Material: alumínio



Spot 1 850lm | 2700K | 1000lm | 3000K  
Spot 2 850lm | 2700K | 1000lm | 3000K

Variante	Art. n.º	EUR
● Antracite	1007668	● 229,00



1007236 714

## I-RING WL

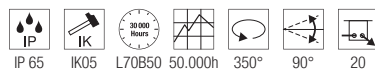
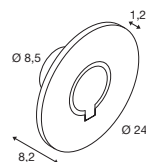

100-240V ~50/60Hz | 350mA  
Potência total: 9,2W  
Material: alumínio



IRC  
80

Down

670lm | 3000K

Variante	Art. n.º	EUR
● Antracite	1007236	● 164,00



**OVAL 14**  
WL, up/down

**OVAL 18**  
WL, up/down

1007142 715

NEW



NEW

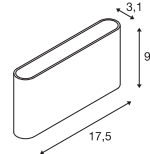
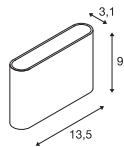

220-240V ~50/60Hz | 145mA  
Potência total: 5,7W  
Material: alumínio/policarbonato (PC)

220-240V ~50/60Hz | 275mA  
Potência total: 9,3W  
Material: alumínio/policarbonato (PC)



Up	280lm	2700K	280lm	3000K
Down	280lm	2700K	280lm	3000K

Up	430lm	2700K	430lm	3000K
Down	430lm	2700K	430lm	3000K

Variante	Art. n.º	EUR
● Preto	1007142	73,00
○ Branco	1007143	73,00

Variante	Art. n.º	EUR
● Preto	1007144	87,00
○ Branco	1007145	87,00

1006405 717





## CONCRETO M WL

## CONCRETO L WL

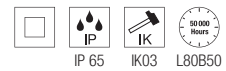
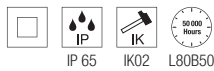
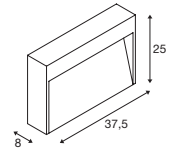
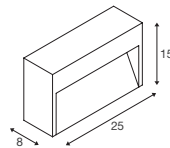

220-240V ~50/60Hz | 700mA  
Potência total: 8,5W  
Material: betão/alumínio

220-240V ~50/60Hz | 700mA  
Potência total: 12W  
Material: betão/alumínio



Down 270lm | 3000K



Down 470lm | 3000K

Variante	Art. n.º	EUR
● Cinzento	1006404	● 200,00

Variante	Art. n.º	EUR
● Cinzento	1006405	● 260,00

JAS DOMINICAS

ONASTERIO  
A CATALINA DE SIENA



### VANO WING SP, DALI

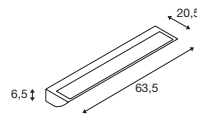

220-240V ~50/60Hz | 500mA  
Potência total: 25W  
Material: alumínio/vidro



Down 1400lm | 3000K

Variante	Art. n.º	EUR
● Cinzento	1006268	429,00

### VANO WING SP, DALI

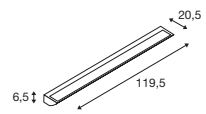

220-240V ~50/60Hz | 1050mA  
Potência total: 49W  
Material: alumínio/vidro



Down 3140lm | 3000K

Variante	Art. n.º	EUR
● Cinzento	1006270	529,00

MANA BASE  
WL, Redondo, PHASE

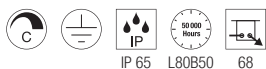
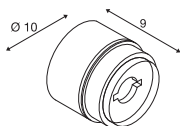

220-240V ~50/60Hz | 350mA  
Potência total: 15W  
Material: alumínio/policarbonato (PC)



Down 800lm | 2700K | 820lm | 3000K

Variante	Art. n.º	EUR
● Antracite	1006319	189,00

RUSTY® MANA  
Abajur, quadrado



NEW

C: 28 cm L: 28 cm A: 1,5 cm  
Material: aço corten

Variante	Art. n.º	EUR
● Oxidado	1006317	59,00

RUSTY® MANA  
Abajur, redondo



NEW

A: 1,5 cm Ø: 28 cm  
Material: aço corten

Variante	Art. n.º	EUR
● Oxidado	1006318	59,00

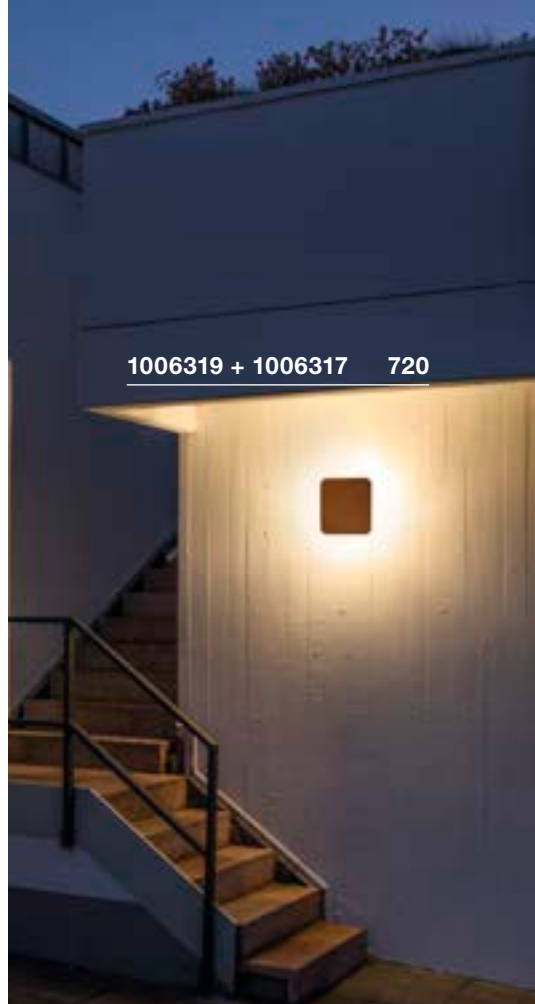

1006319 + 1006317 720



1003470 721





1002902 721



### MANA OUT WL, PHASE

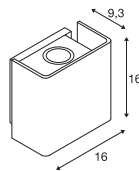

220-240V ~50/60Hz | 500mA  
Potência total: 11W  
Material: alumínio/alumínio



Up 325lm | 3000K  
Down 325lm | 3000K

Variante	Art. n.º	EUR
● Antracite	1002900	239,00
● Oxidado	1002902	239,00

### MANA OUT WL, Set

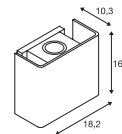

220-240V ~50/60Hz | 500mA  
Potência total: 11W  
Material: alumínio/betão



Up 325lm | 3000K  
Down 325lm | 3000K

Variante	Art. n.º	EUR
● Cinzento	1003470	272,00

1006328 723

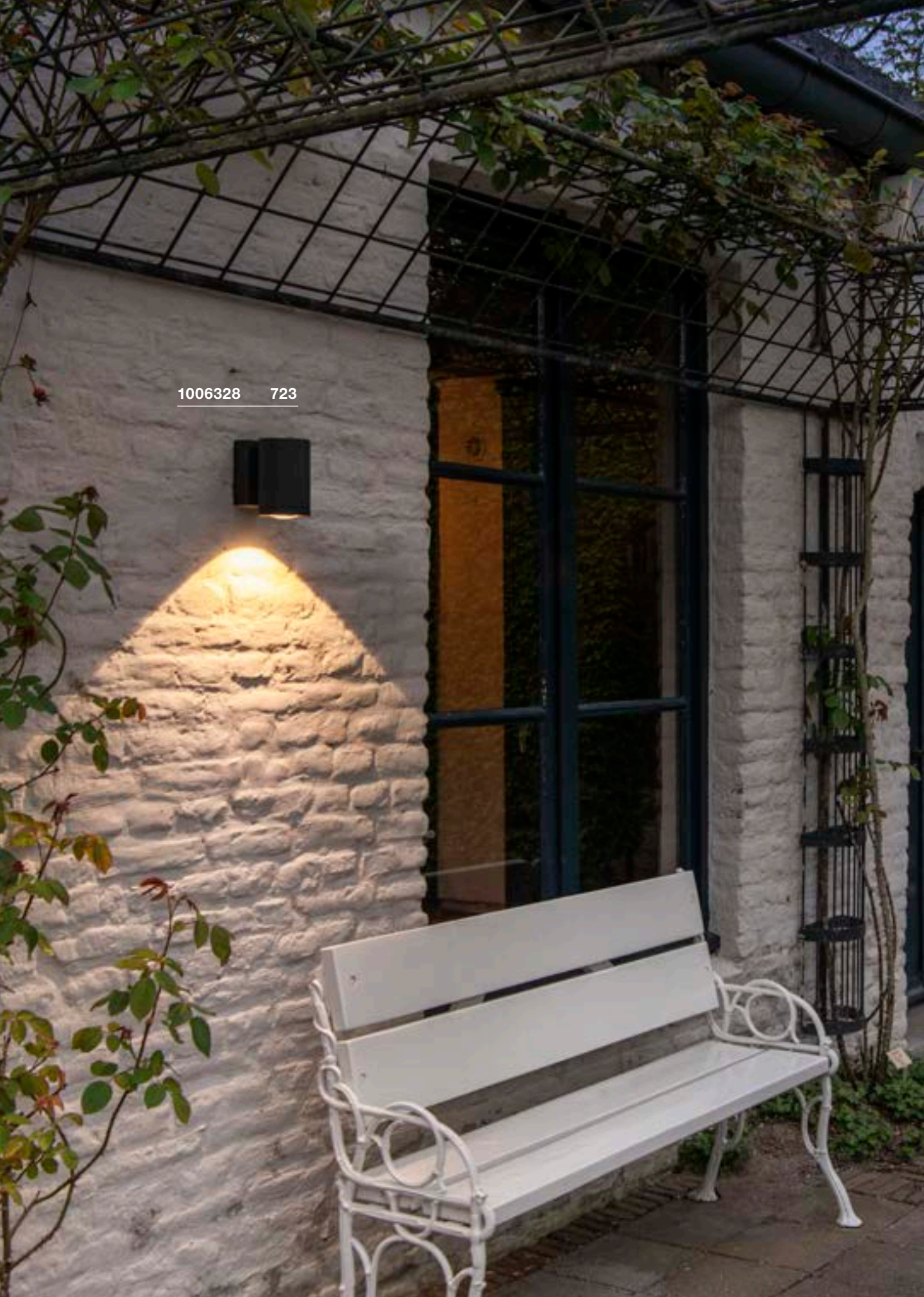



### ENOLA OCULUS WL, single

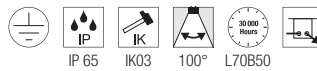
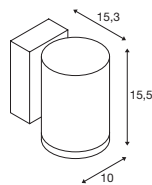

220-240V ~50/60Hz | 500mA  
Potência total: 11W  
Material: alumínio/vidro



Down	1000lm   3000K	1100lm   4000K
------	----------------	----------------

Variante	Art. n.º	EUR
● Antracite	1006328	● 273,00



Artigo	Art. n.º	EUR
Espaçador		
● Antracite	1002853	7,75

### ENOLA OCULUS WL, up/down

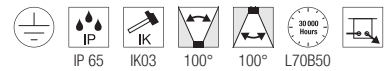
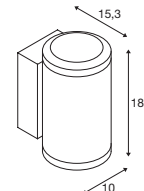

220-240V ~50/60Hz | 500mA  
Potência total: 20W  
Material: alumínio/vidro



Up	940lm   3000K	1060lm   4000K
Down	940lm   3000K	1060lm   4000K

Variante	Art. n.º	EUR
● Antracite	1006329	● 344,00



Artigo	Art. n.º	EUR
Espaçador		
● Antracite	1002853	7,75

1006329 723

1003440 725





### ENOLA ROUND S WL, single

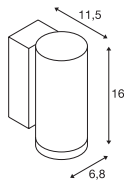

100-240V ~50/60Hz | 500mA  
Potência total: 6W  
Material: alumínio/vidro



Down 450lm | 3000K | 500lm | 4000K

Variante	Art. n.º	EUR
● Antracite	1003422	200,00



Artigo	Art. n.º	EUR
Espaçador		
● Antracite	1002853	7,75
Refletor 60°		
● Cromado	1005262	16,40

### ENOLA ROUND M WL, single

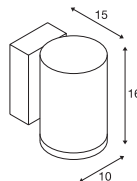

220-240V ~50/60Hz | 500mA  
Potência total: 11W  
Material: alumínio/vidro



Down 860lm | 3000K | 980lm | 4000K

Variante	Art. n.º	EUR
● Antracite	1003423	245,00



Artigo	Art. n.º	EUR
Espaçador		
● Antracite	1002853	7,75
Lente de 19°		
● Preto/cromado	1005205	41,75
Lente assimétrica		
● Preto/cromado	1005206	41,75
Refletor 60°		
● Cromado	1005207	24,75

### ENOLA ROUND L WL, single

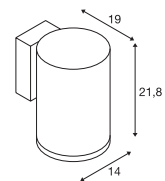

220-240V ~50/60Hz | 900mA  
Potência total: 36W  
Material: alumínio/vidro



Down 3300lm | 3000K | 3700lm | 4000K

Variante	Art. n.º	EUR
● Antracite	1003440	343,00



Artigo	Art. n.º	EUR
Espaçador		
● Antracite	1002853	7,75
Refletor 60°		
● Cromado	1005263	21,50



1003441 727



### ENOLA ROUND S UP/DOWN WL

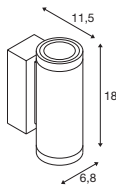

220-240V ~50/60Hz | 350mA  
Potência total: 7,8W  
Material: alumínio/vidro



Up	310lm	3000K	350lm	4000K
Down	310lm	3000K	350lm	4000K

Variante	Art. n.º	EUR
● Antracite	1003424	245,00



Artigo	Art. n.º	EUR
Espaçador		
● Antracite	1002853	7,75
Refletor 60°		
● Cromado	1005262	16,40

### ENOLA ROUND M UP/DOWN WL

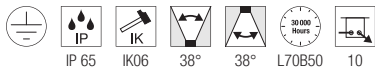
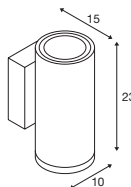

220-240V ~50/60Hz | 500mA  
Potência total: 20W  
Material: alumínio/vidro



Up	830lm	3000K	950lm	4000K
Down	830lm	3000K	950lm	4000K

Variante	Art. n.º	EUR
● Antracite	1003425	300,00



Artigo	Art. n.º	EUR
Espaçador		
● Antracite	1002853	7,75
Lente de 19°		
● Preto/cromado	1005205	41,75
Lente assimétrica		
● Preto/cromado	1005206	41,75
Refletor 60°		
● Cromado	1005207	24,75

### ENOLA ROUND L UP/DOWN WL

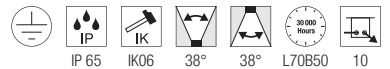
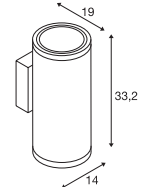

220-240V ~50/60Hz | 700mA  
Potência total: 55W  
Material: alumínio/vidro



Up	2700lm	3000K	3000lm	4000K
Down	2700lm	3000K	3000lm	4000K

Variante	Art. n.º	EUR
● Antracite	1003441	470,00



Artigo	Art. n.º	EUR
Espaçador		
● Antracite	1002853	7,75
Refletor 60°		
● Cromado	1005263	21,50



1003416 729

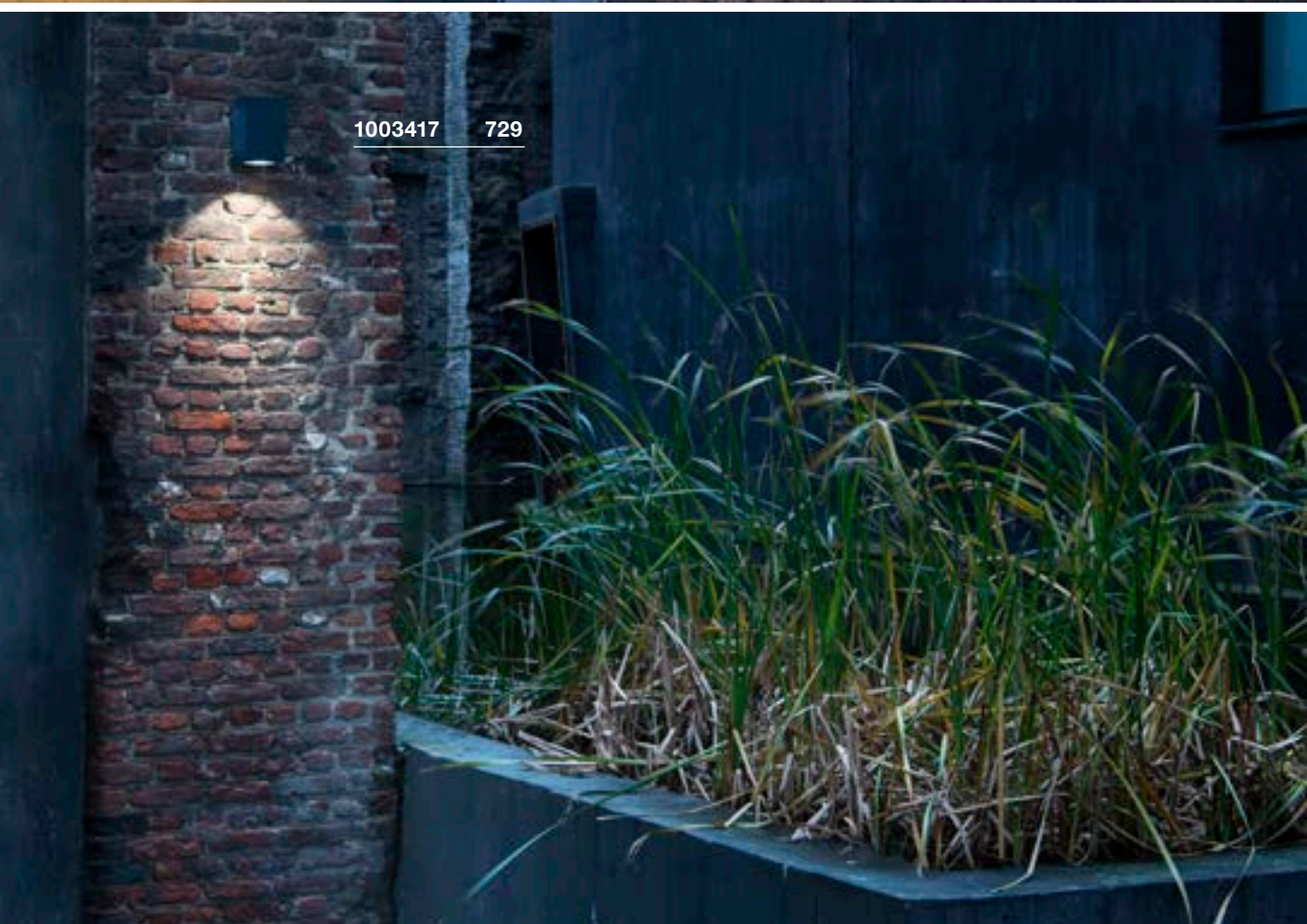

1003417 729





### ENOLA SQUARE S WL, single

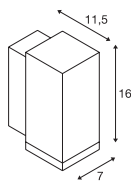

100-240V ~50/60Hz | 500mA  
Potência total: 6W  
Material: alumínio/vidro



Down 450lm | 3000K | 500lm | 4000K

Variante	Art. n.º	EUR
● Antracite	1003416	200,00



Artigo	Art. n.º	EUR
Espaçador		
● Antracite	1002853	7,75
Refletor 60°		
● Cromado	1005262	16,40

### ENOLA SQUARE M WL, single

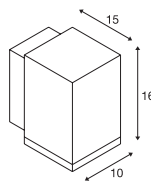

220-240V ~50/60Hz | 500mA  
Potência total: 11W  
Material: alumínio/vidro



Down 860lm | 3000K | 980lm | 4000K

Variante	Art. n.º	EUR
● Antracite	1003417	245,00



Artigo	Art. n.º	EUR
Espaçador		
● Antracite	1002853	7,75
Lente de 19°		
● Preto/cromado	1005205	41,75
Lente assimétrica		
● Preto/cromado	1005206	41,75
Refletor 60°		
● Cromado	1005207	24,75

### ENOLA SQUARE L WL, single

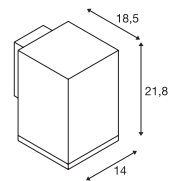

220-240V ~50/60Hz | 900mA  
Potência total: 36W  
Material: alumínio/vidro



Down 3300lm | 3000K | 3700lm | 4000K

Variante	Art. n.º	EUR
● Antracite	1003437	343,00



Artigo	Art. n.º	EUR
Espaçador		
● Antracite	1002853	7,75
Refletor 60°		
● Cromado	1005263	21,50

## ENOLA SQUARE S UP/DOWN WL

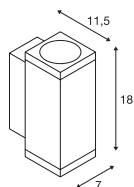

220-240V ~50/60Hz | 350mA  
Potência total: 7,8W  
Material: alumínio/vidro



Up	310lm	3000K	350lm	4000K
Down	310lm	3000K	350lm	4000K

Variante	Art. n.º	EUR
● Antracite	1003418	245,00



Artigo	Art. n.º	EUR
Espaçador		
● Antracite	1002853	7,75
Refletor 60°		
● Cromado	1005262	16,40

## ENOLA SQUARE M UP/DOWN WL

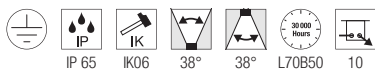
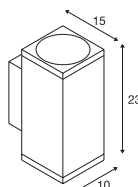

220-240V ~50/60Hz | 500mA  
Potência total: 20W  
Material: alumínio/vidro



Up	830lm	3000K	950lm	4000K
Down	830lm	3000K	950lm	4000K

Variante	Art. n.º	EUR
● Antracite	1003419	300,00



Artigo	Art. n.º	EUR
Espaçador		
● Antracite	1002853	7,75
Lente de 19°		
● Preto/cromado	1005205	41,75
Lente assimétrica		
● Preto/cromado	1005206	41,75
Refletor 60°		
● Cromado	1005207	24,75

## ENOLA SQUARE L UP/DOWN WL

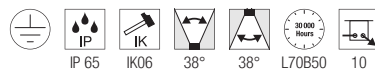
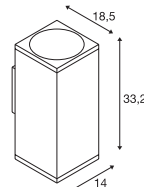

220-240V ~50/60Hz | 700mA  
Potência total: 55W  
Material: alumínio/vidro



Up	2700lm	3000K	3000lm	4000K
Down	2700lm	3000K	3000lm	4000K

Variante	Art. n.º	EUR
● Antracite	1003438	470,00



Artigo	Art. n.º	EUR
Espaçador		
● Antracite	1002853	7,75
Refletor 60°		
● Cromado	1005263	21,50



ENOLA S, M, L  
Refletor, 56°



S | A: 1,85 cm Ø: 4,5 cm  
M | A: 4,00 cm Ø: 7,5 cm  
L | A: 6,96 cm Ø: 11 cm  
Material: policarbonato (PC)



Variante	Art. n.º	EUR
● Cromado   S	1005262	16,40
● Cromado   M	1005207	24,75
● Cromado   L	1005263	21,50



ENOLA M  
Lente, 19°



A: 3,8 cm  
Ø: 7,5 cm  
Material: aço/policarbonato (PC)



Variante	Art. n.º	EUR
● Preto/cromado	1005205	41,75



ENOLA M  
Lente assimétrica



A: 3 cm  
Ø: 7,5 cm  
Material: aço/policarbonato (PC)



Variante	Art. n.º	EUR
● Preto/cromado	1005206	41,75



# EASY TO INSTALL

---

1

## MONTAGEM NA PAREDE.

Aparafusar a placa de montagem na parede com os parafusos de fixação.

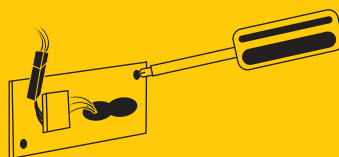

2

## LIGAÇÃO SIMPLES.

Ligar o conector da fonte de alimentação às luminárias LED.

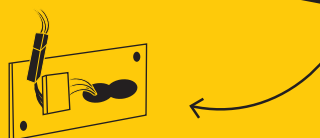

3

## MONTAGEM LIMPA E SEGURA.

Montar a luminária na ranhura de guia prática da placa de montagem e aparafusar o corpo da lâmpada à placa de montagem.



JÁ ESTÁ!

Como a eficiência compensa sempre, as luminárias SLV são de instalação fácil, rápida e segura. Com placas de montagem fixas, cabeças de luminária engancháveis, ligações com grampo de mola, cablagens, entradas de cabo e outros recursos, oferecem vantagens decisivas: economia de tempo, esforço e custos.

## CABEÇAS DE LUMINÁRIA ENGANCHÁVEIS.

Também na nossa família ENOLA®, a cabeça da luminária pode ser separada da placa de montagem fixada na parede. Isso significa que após a suspensão pelo nariz integrado e a ligação elétrica com o conector, ambas as mãos permanecem livres para aparafusar com segurança a luminária.

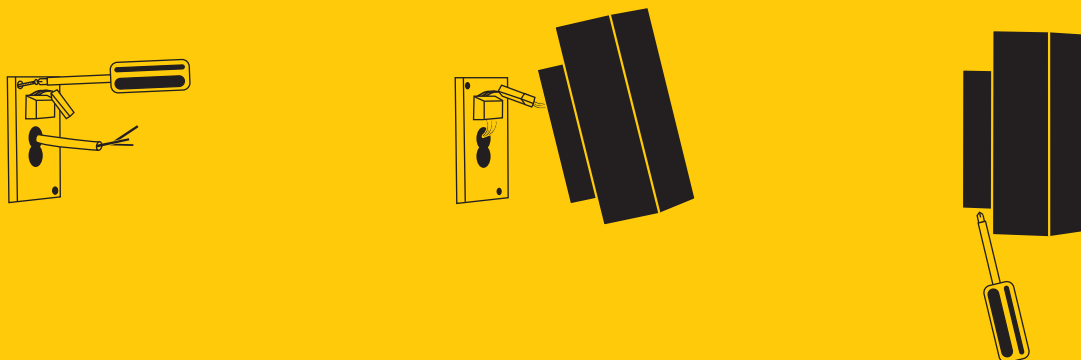

## LIGAÇÕES COM GRAMPO DE MOLA PRÁTICAS.

As luminárias de parede em forma de cubo SITRA CUBE impressionam pela sua simplicidade moderna. Também são instaladas de forma rápida e fácil: basta prender o cabo de ligação diretamente sem ferramentas e ligar o acoplamento da placa de montagem à ficha elétrica da luminária – já está!



## LIGAÇÃO POR COMPLETO.

As nossas luminárias de parede e de teto QUADRULO mostram como é simples o funcionamento da cablagem na prática. São fornecidas duas entradas de cabo em forma de 8 na placa de Casquilho. O terminal de mola também possui duas opções de ligação. Assim, várias luminárias podem ser instaladas de forma rápida e fácil em simultâneo.

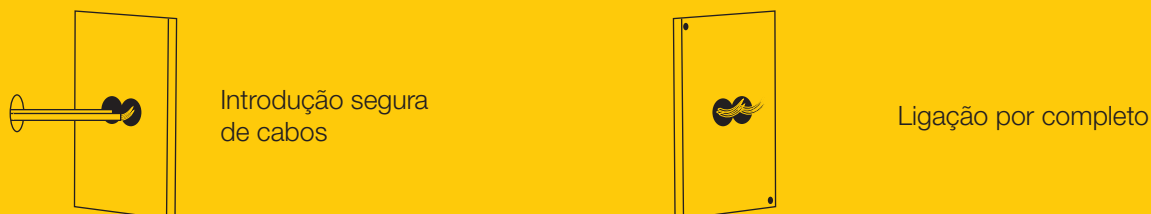



229532 735



234515 735



THEO UP/DOWN  
WL, QPAR51

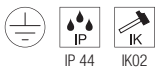
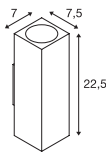

220-240V ~50/60Hz  
Material: alumínio/vidro



Casquilho: 2xGU10

Variante	Art. n.º	EUR
● Antracite	229535	90,00
○ Branco	229531	90,00
● Cinzento	229532	90,00



LED GU10 51mm | 6W | 38°  
2700K | 450lm | EE=F  
6kWh/1000h



Art. N.º: 1005077 | 7,50 EUR

BIG THEO BEAM UP/  
FLOOD DOWN  
WL

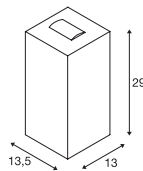

220-240V ~50/60Hz | 500mA  
Potência total: 29W  
Material: alumínio/vidro



Up 130lm | 3000K  
Down 2000lm | 3000K

Variante	Art. n.º	EUR
● Antracite	234515	279,00

BIG THEO UP/DOWN  
WL, QPAR111

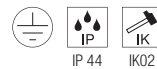
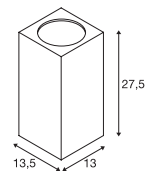

220-240V ~50/60Hz  
Material: alumínio/vidro



Casquilho: 2xGU10

Variante	Art. n.º	EUR
● Antracite	229575	179,00
● Cinzento	229574	179,00



QPAR111 | 12,5W | 10°  
3000K | 950lm | EE=F  
13kWh/1000h



Art. N.º: 1005278 | 55,00 EUR

BIG THEO FLOOD UP/DOWN  
WL

THEO  
WL, QPAR51

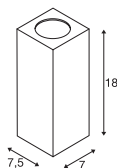
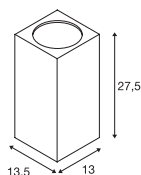

220-240V ~50/60Hz | 1000mA  
Potência total: 42W  
Material: alumínio/vidro



Up 2000lm | 3000K  
Down 2000lm | 3000K

Variante	Art. n.º	EUR
● Antracite	234505	314,00



220-240V ~50/60Hz  
Material: alumínio/vidro



Casquilho: 1xGU10

Variante	Art. n.º	EUR
● Antracite	229525	75,00
● Cinzento	229524	75,00



LED GU10 51mm | 6W | 38°  
2700K | 450lm | EE=F  
6kWh/1000h



Art. N.º: 1005077 | 7,50 EUR



234505 736







## BIG THEO WL, QPAR111

## BIG THEO WL

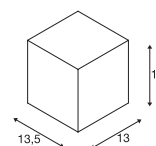
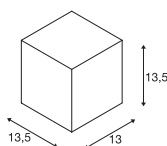

IP 44

220-240V ~50/60Hz  
Material: alumínio/vidro



Casquilho: 1xGU10

Variante	Art. n.º	EUR
● Antracite	229565	113,00
● Cinzento	229564	113,00



100-277V ~50/60Hz | 500mA  
Potência total: 21W  
Material: alumínio/vidro



Down

2000lm | 3000K

Variante	Art. n.º	EUR
● Antracite	234525	224,00



QPAR111 | 12,5W | 10°  
3000K | 950lm | EE=F  
13kWh/1000h



Art. N.º: 1005278 | 55,00 EUR

234525 737



1002032 739



SITRA S  
WL, single, Quadrado

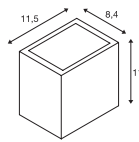

100-277V ~50/60Hz | 500mA  
Potência total: 11W  
Material: alumínio



Up	550lm	3000K	635lm	4000K
Down	550lm	3000K	635lm	4000K

Variante	Art. n.º	EUR
● Antracite	1002032	119,00
○ Branco	1002033	119,00
● Oxidado	1002034	119,00

SITRA S  
WL, single, Quadrado

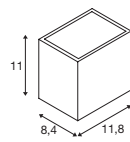

220-240V ~50/60Hz | 500mA  
Potência total: 6,2W  
Material: alumínio/vidro



Down	580lm	3000K	620lm	4000K
------	-------	-------	-------	-------

Variante	Art. n.º	EUR
● Antracite	1005148	99,00
○ Branco	1005149	99,00
● Oxidado	1005150	99,00



232531    741

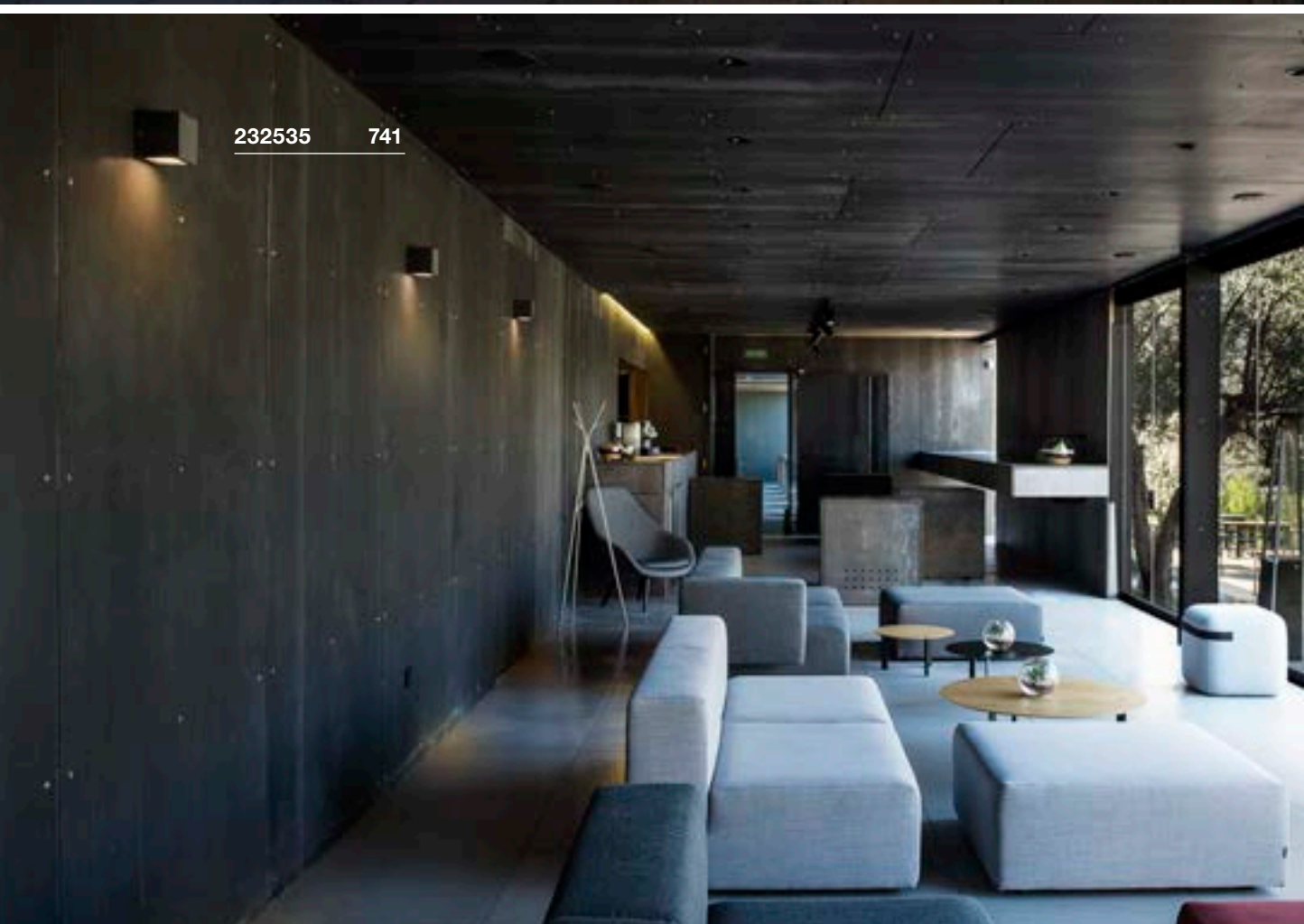

232535    741



SITRA M  
WL, up/down, Quadrado

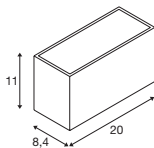

220-240V ~50/60Hz | 350mA  
Potência total: 14W  
Material: alumínio



Up	850lm	3000K	940lm	4000K
Down	850lm	3000K	940lm	4000K

Variante	Art. n.º	EUR
● Antracite		
1700 / 1880lm	<b>1005151</b>	<b>145,00</b>
○ Branco		
1700 / 1880lm	<b>1005153</b>	<b>145,00</b>
● Oxidado		
1600 / 1700lm	<b>1005154</b>	<b>145,00</b>

SITRA L  
WL, up/down, Quadrado

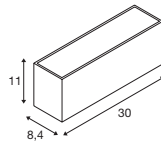

220-240V ~50/60Hz | 600mA  
Potência total: 24W  
Material: alumínio



Up	1400lm	3000K	1530lm	4000K
Down	1400lm	3000K	1530lm	4000K

Variante	Art. n.º	EUR
● Antracite	<b>1005155</b>	<b>184,00</b>
○ Branco	<b>1005156</b>	<b>184,00</b>
● Oxidado	<b>1005157</b>	<b>184,00</b>

SITRA CUBE  
WL, TCR-TSE

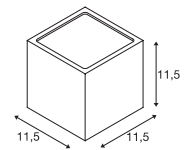

220-240V ~50/60Hz  
Material: alumínio/vidro



Casquilho: 2xGX53 Máx. Ø: 7,5 cm | C: 2,7 cm

Variante	Art. n.º	EUR
● Antracite	<b>232535</b>	<b>78,00</b>
○ Branco	<b>232531</b>	<b>78,00</b>
● Oxidado	<b>232537</b>	<b>78,00</b>



LED GX53 | 6,1W | 120°  
3000K | 490lm | EE=G  
6kWh/1000h



Art. N.º: **1005271** | **11,50 EUR**

GRAFIT  
WL, Redondo, sensor, E27

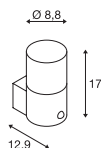

220-240V ~50/60Hz  
Material: alumínio/acrílico



Casquilho: 1xE27 Máx. Ø: 6 cm C: 11,5 cm

Variante	Art. n.º	EUR
● Antracite	1006179	90,00



LED E27 | 8W | 240°  
3000K | 880lm | EE=E  
8kWh/1000h



Art. N.º: 1005289 | 10,25 EUR

GRAFIT  
WL, Redondo, E27

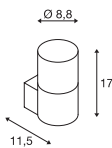

220-240V ~50/60Hz  
Material: alumínio/acrílico



Casquilho: 1xE27 Máx. Ø: 6 cm C: 11,5 cm

Variante	Art. n.º	EUR
● Antracite	1006178	80,00



A60 | 7,5W | 320°  
2700K | 800lm | EE=F  
8kWh/1000h



Art. N.º: 1005303 | 9,60 EUR

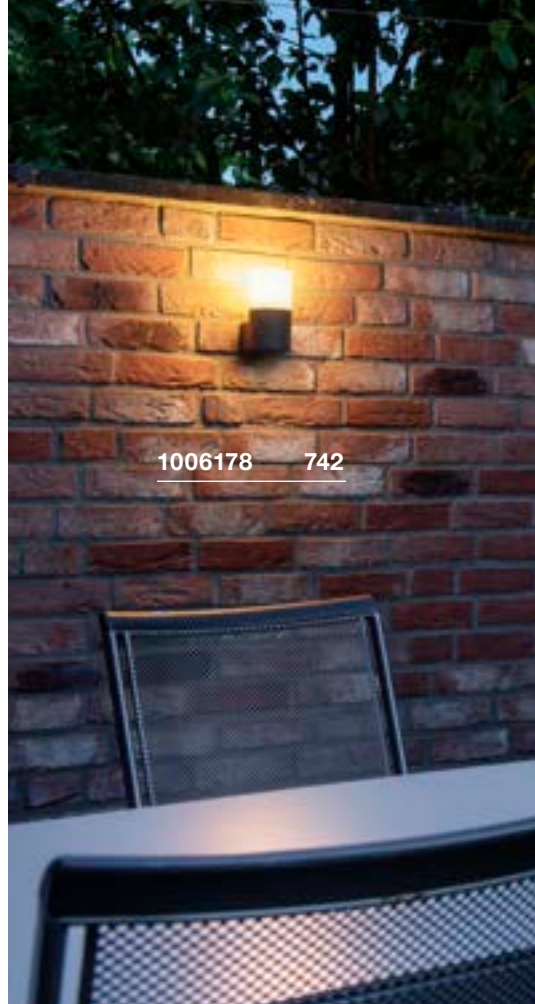

1006178 742





**GRAFIT**  
WL, Quadrado, sensor, E27

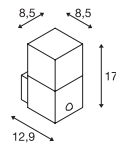

**GRAFIT**  
WL, Quadrado, E27

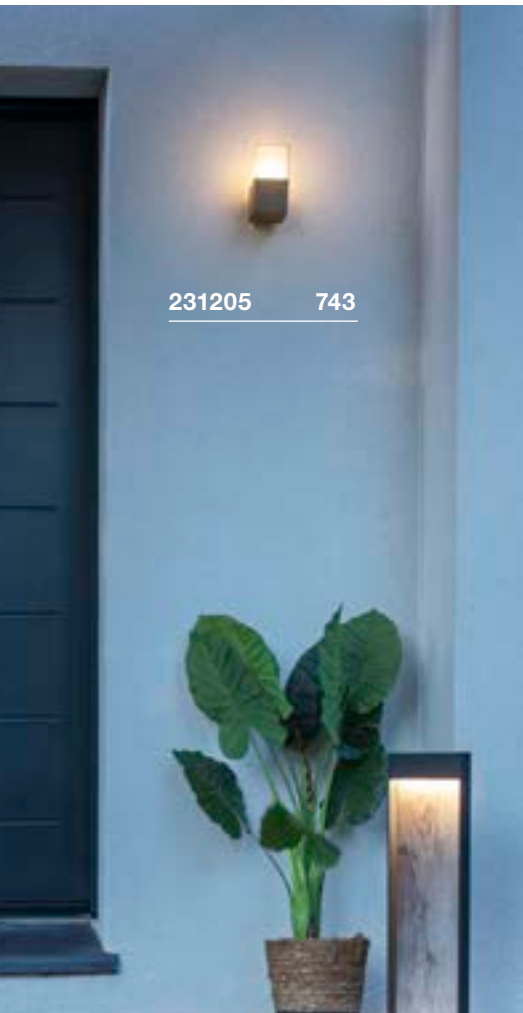
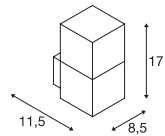

231205 743



220-240V ~50/60Hz  
Material: alumínio/acrílico



Casquilha: 1xE27 Máx. Ø: 6 cm | C: 11,5 cm

Variante	Art. n.º	EUR
● Antracite	1006183	90,00



A60 | 7,5W | 320°  
2700K | 800lm | EE=F  
8kWh/1000h



Art. N.º: 1005303 | 9,60 EUR



220-240V ~50/60Hz  
Material: alumínio/plástico



Casquilha: 1xE27 Máx. Ø: 6 cm | C: 11,5 cm

Variante	Art. n.º	EUR
● Antracite	231205	80,00



A60 | 7,5W | 320°  
2700K | 800lm | EE=F  
8kWh/1000h



Art. N.º: 1005303 | 9,60 EUR

# QUADRULO WL



NEW

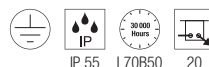
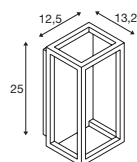

100-277V ~50/60Hz | 350mA  
Potência total: 7,4W  
Material: alumínio/cloreto de polivinilo (PVC)



Down 270lm | 280lm | 3000K

Variante	Art. n.º	EUR
● Antracite 270lm	1005201	166,00
● Antracite/madeira 280lm	1007207	149,00





1002402 745

QUADRULO SENSOR  
WL, E27

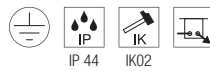
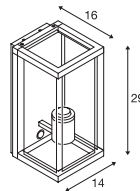

220-240V ~50/60Hz  
Material: alumínio/vidro

**SOCKET INSIDE** <15 W

Casquilho: 1xE27 Máx. Ø: 8 cm C: 18 cm

Variante	Art. n.º	EUR
● Antracite	1002402	172,00



LED E27 | 7,5W | 320°  
2500K | 700lm | EE=F  
8kWh/1000h



Art. N.º: 1005265 | 26,50 EUR

QUADRULO  
WL, E27

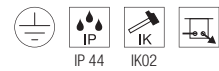
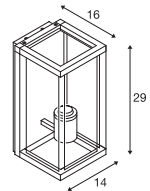

220-240V ~50/60Hz  
Material: alumínio/vidro

**SOCKET INSIDE** <15 W

Casquilho: 1xE27 Máx. Ø: 8 cm C: 18 cm

Variante	Art. n.º	EUR
● Antracite	1002403	149,00



LED E27 | 7,5W | 320°  
2500K | 700lm | EE=F  
8kWh/1000h



Art. N.º: 1005265 | 26,50 EUR



1002403 745

MERIDIAN  
WL, E27

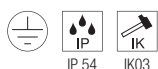
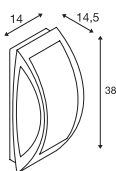

220-240V ~50/60Hz  
Material: alumínio/policarbonato (PC)



Casquilha: 1xE27 Máx. Ø: 7 cm C: 17,5 cm

Variante	Art. n.º	EUR
● Antracite	230445	79,00
● Cinzento	230444	79,00



LED E27 | 8W | 240°  
3000K | 880lm | EE=E  
8kWh/1000h



Art. N.º: 1005289 | 10,25 EUR

MERIDIAN BOX  
WL, E27

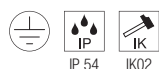
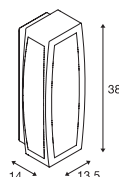

220-240V ~50/60Hz  
Material: alumínio/policarbonato (PC)



Casquilha: 1xE27 Máx. Ø: 7 cm C: 17,5 cm

Variante	Art. n.º	EUR
● Antracite	230045	100,00
● Cinzento	230044	100,00



| 13,5W | 240°  
4000K | 1600lm | EE=E  
14kWh/1000h



Art. N.º: 1005308 | 12,50 EUR





230445 746

### MERIDIAN BOX SENSOR WL, E27

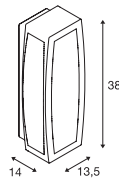

220-240V ~50/60Hz  
Material: alumínio/policarbonato (PC)

- Pode ajustar-se a intensidade luminosa ambiente e o ciclo de funcionamento.



Casquilho: 1xE27 Máx. Ø: 7 cm | C: 17,5 cm

Variante	Art. n.º	EUR
● Antracite	230085	166,00
● Cinzento	230084	166,00



LED E27 | 8W | 240°  
3000K | 880lm | EE=E  
8kWh/1000h



Art. N.º: 1005289 | 10,25 EUR

### MERIDIAN BOX WL, E27

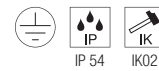
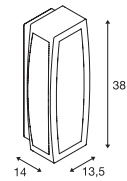

220-240V ~50/60Hz  
Material: alumínio/policarbonato (PC)



Casquilho: 1xE27 Máx. Ø: 7 cm | C: 17,5 cm

Variante	Art. n.º	EUR
● Antracite	230655	112,00
● Oxidado	230657	112,00



LED E27 | 7,5W | 320°  
2500K | 700lm | EE=F  
8kWh/1000h



Art. N.º: 1005265 | 26,50 EUR



230655 747

1004748 749



1006314 749

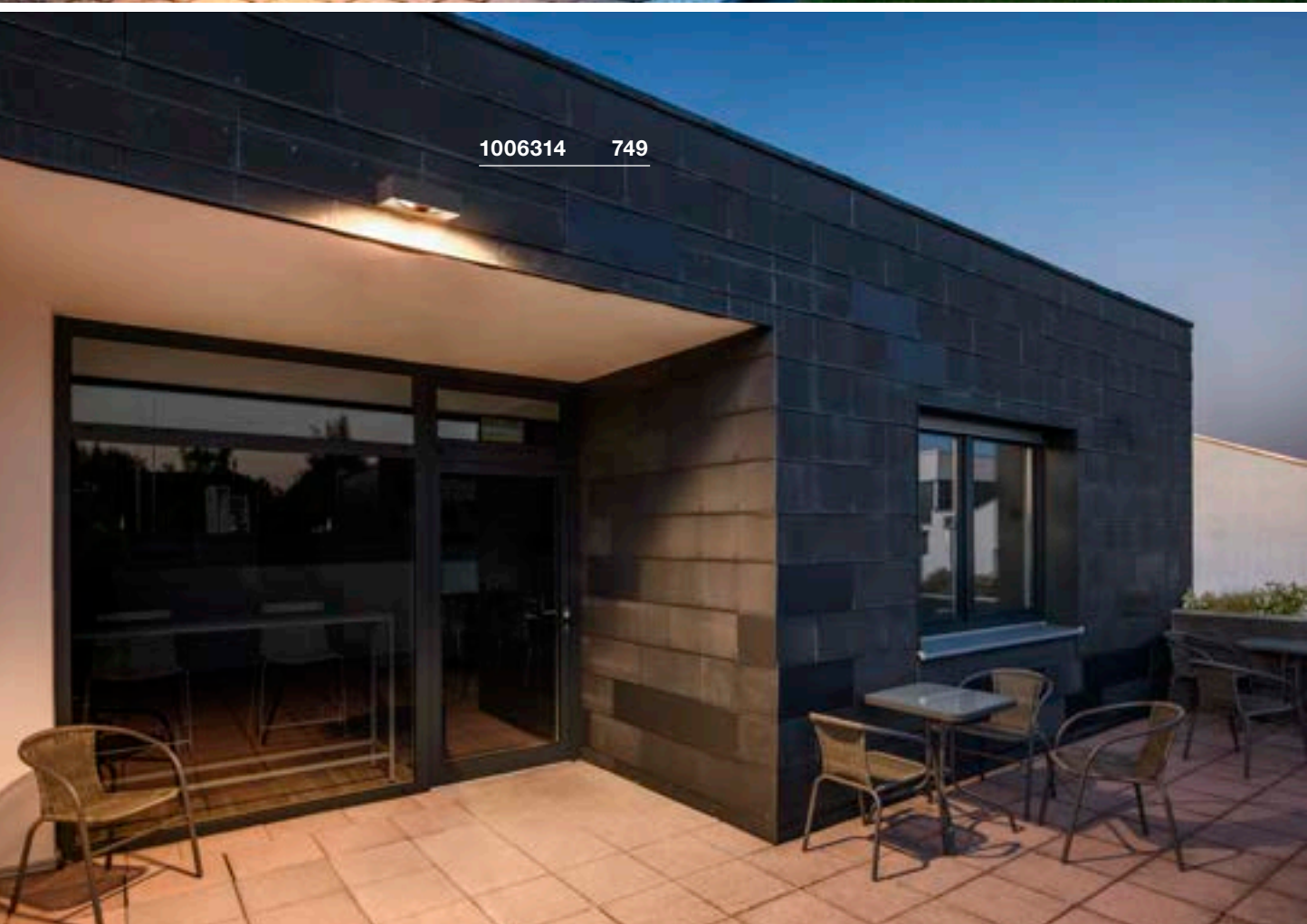



### ESKINA FRAME WL

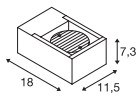

220-240V ~50/60Hz | 350mA  
Potência total: 15W  
Material: alumínio



Down	1100lm   3000K	1200lm   4000K
------	----------------	----------------

Variante	Art. n.º	EUR
● Antracite	1004747	222,00

### ESKINA FRAME WL, double

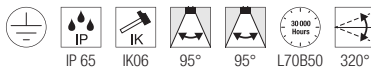
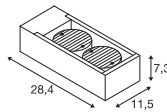

220-240V ~50/60Hz | 700mA  
Potência total: 27W  
Material: alumínio



Spot 1	1100lm   3000K	1200lm   4000K
Spot 2	1100lm   3000K	1200lm   4000K

Variante	Art. n.º	EUR
● Antracite	1004748	272,00

### ESKINA FRAME WL, double

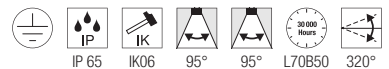
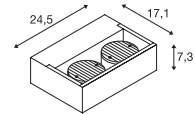

220-240V ~50/60Hz | 700mA  
Potência total: 27W  
Material: alumínio



Spot 1	1100lm   3000K	1200lm   4000K
Spot 2	1100lm   3000K	1200lm   4000K

Variante	Art. n.º	EUR
● Antracite	1006314	272,00

1005443 751

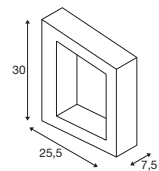
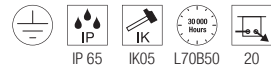

**BOOKAT  
WL****1005441 683**

IP 65 IK05 L70B50 20

100-277V ~50/60Hz | 700mA  
Potência total: 15W  
Material: alumínio

Down 920lm | 3000K | 990lm | 4000K

Variante	Art. n.º	EUR
● Antracite	1005443	201,00

**BIG QUAD**  
WL

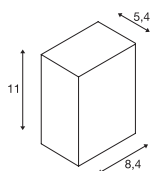

100-240V ~50/60Hz | 350mA  
Potência total: 4,5W  
Material: alumínio/vidro



Down 260lm | 3000K

Variante	Art. n.º	EUR
● Antracite	232435	119,00

**QUAD**  
WL

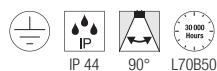
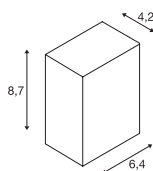

200-240V ~50/60Hz | 700mA  
Potência total: 4,6W  
Material: alumínio/vidro



Down 80lm | 3000K  
100lm | 3000K

Variante	Art. n.º	EUR
● Antracite	232465	84,00
○ Branco	232461	84,00

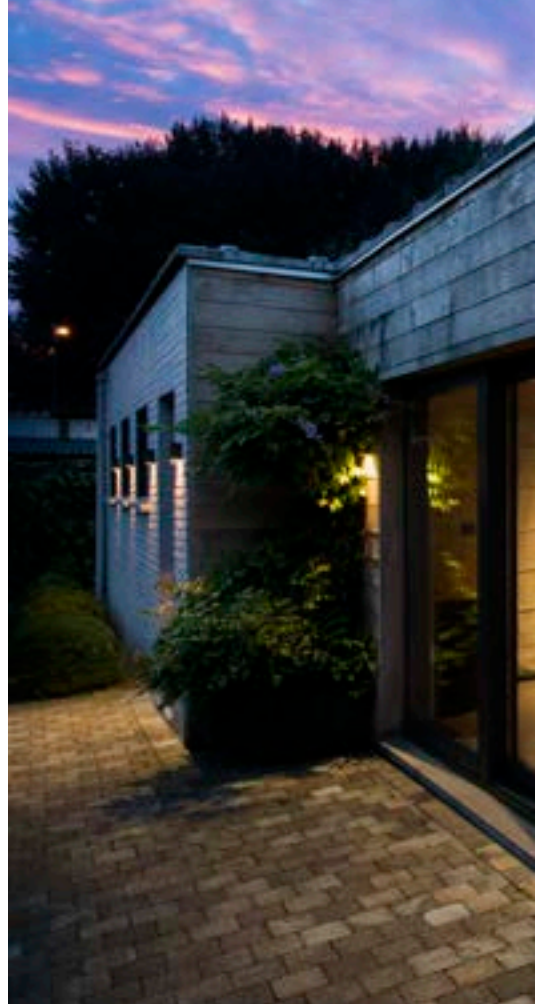





## QUAD UP/DOWN 15 WL



232435 752

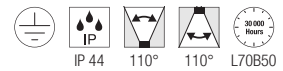
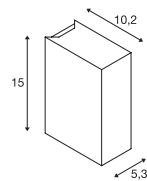

100-277V ~50/60Hz | 350mA  
Potência total: 8W  
Material: alumínio/vidro



Up	260lm	3000K
Down	260lm	3000K

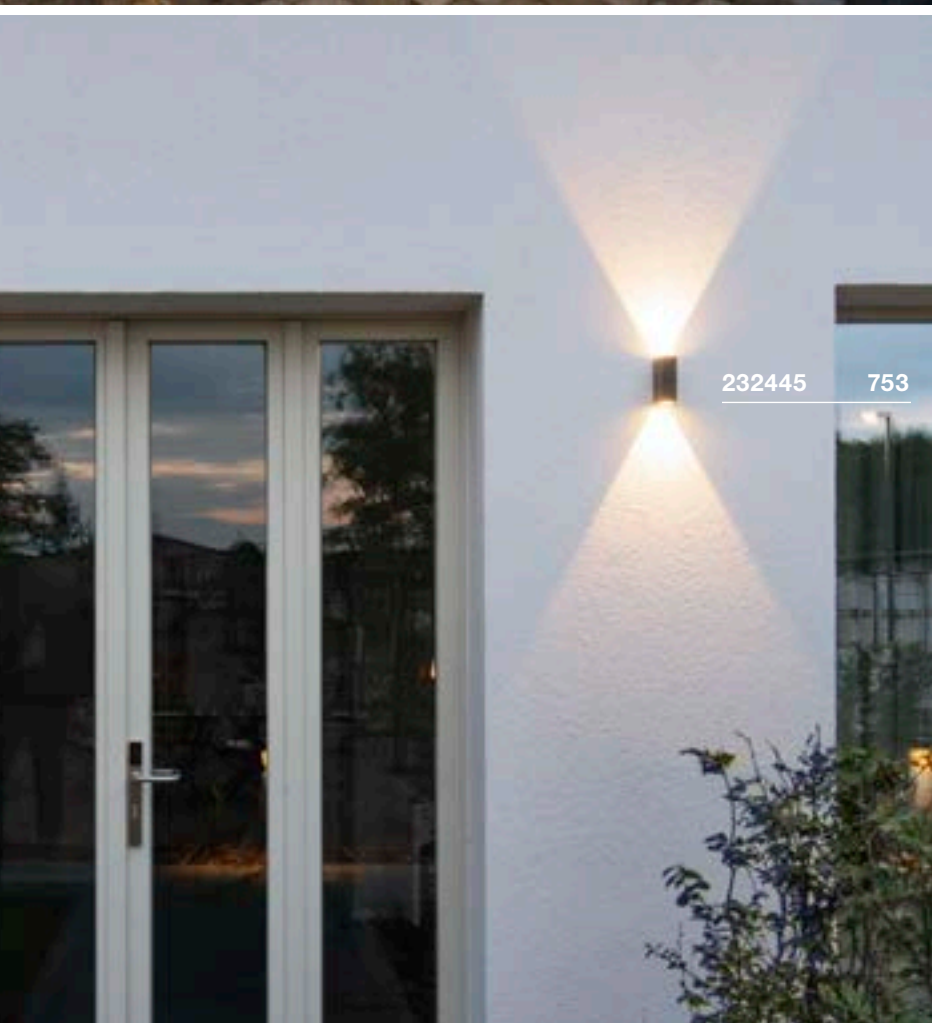

232445 753

Variante	Art. n.º	EUR
● Antracite		
520lm	<b>232445</b>	<b>129,00</b>
○ Branco		
580lm	<b>232441</b>	<b>129,00</b>

1005126 755

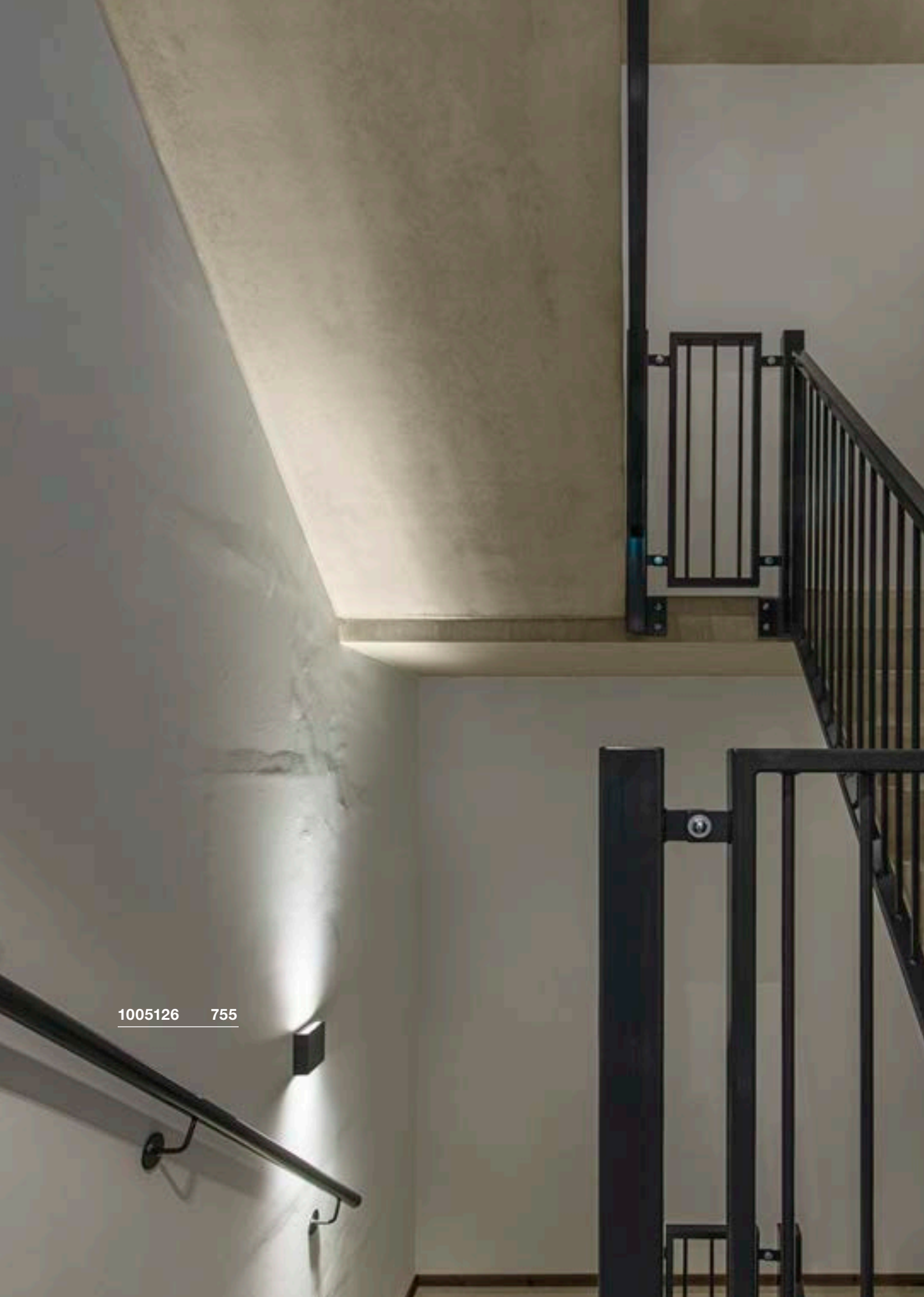



### BIG QUAD UP/DOWN WL

### BIG QUAD WL

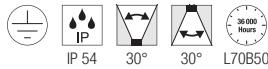
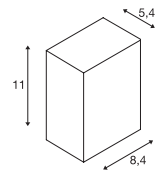
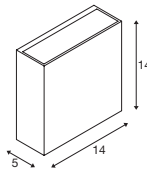

220-240V ~50/60Hz | 500mA  
 Potência total: 8,2W  
 Material: alumínio/vidro

100-240V ~50/60Hz | 350mA  
 Potência total: 4,5W  
 Material: alumínio/vidro



Up 320lm | 3000K  
 Down 320lm | 3000K

Down 290lm | 3000K

Variante	Art. n.º	EUR
● Antracite	1005126	169,00
○ Branco	1005125	169,00

Variante	Art. n.º	EUR
○ Branco	232431	119,00

RUSTY® UP/DOWN  
WL, Quadrado

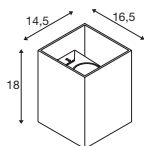

220-240V ~50/60Hz | 350mA  
Potência total: 14W  
Material: aço corten/alumínio



Up	259lm	3000K	260lm	4000K
Down	285lm	3000K	288lm	4000K

Variante	Art. n.º	EUR
● Oxidado/antracite	1004650	282,00

RUSTY® UP/DOWN  
WL, Redondo

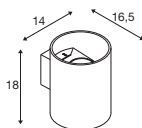

220-240V ~50/60Hz | 350mA  
Potência total: 14W  
Material: aço corten/alumínio



Up	249lm	3000K	254lm	4000K
Down	267lm	3000K	271lm	4000K

Variante	Art. n.º	EUR
● Oxidado/antracite	1004651	282,00

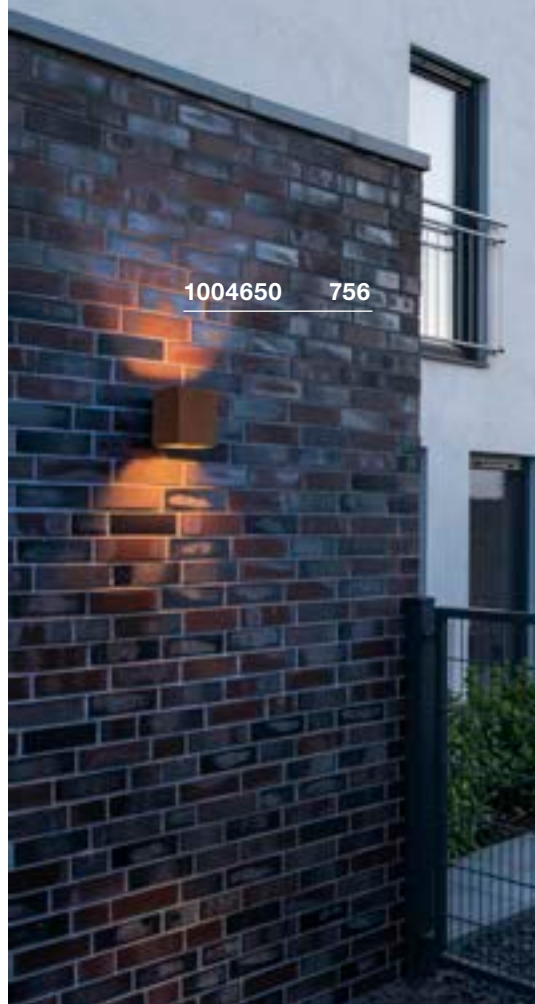



### OVALISK SENSOR WL

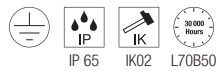
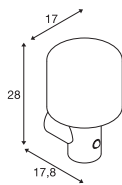

220-240V ~50/60Hz | 500mA  
Potência total: 9,6W  
Material: alumínio/vidro



Down 580lm | 3000K | 630lm | 4000K

Variante	Art. n.º	EUR
● Antracite	1004679	289,00

### OVALISK WL

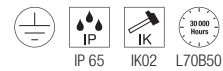
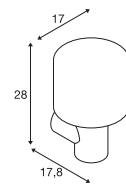

220-240V ~50/60Hz | 500mA  
Potência total: 9,2W  
Material: alumínio/vidro



Down 580lm | 3000K | 630lm | 4000K

Variante	Art. n.º	EUR
● Antracite	1004678	272,00



1004679 757

PEMA®  
WL

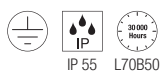
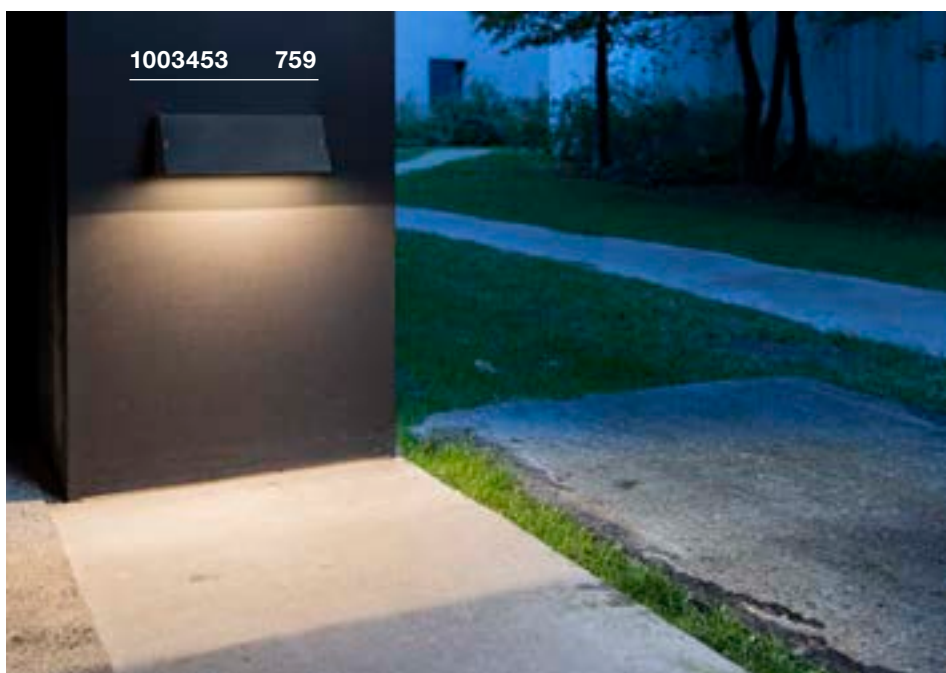
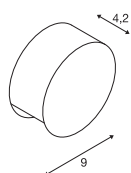
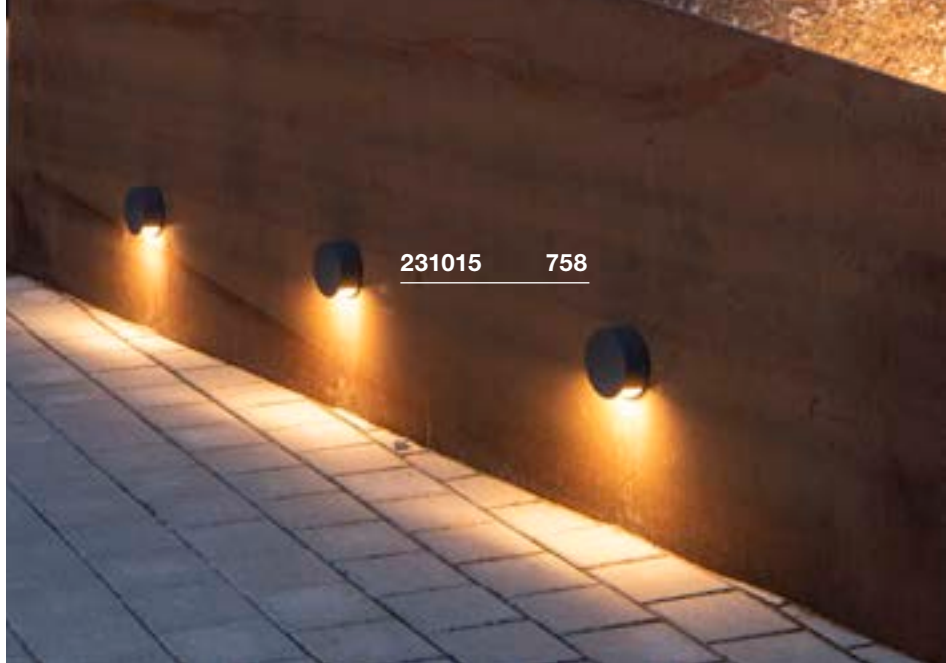

220-240V ~50/60Hz  
Potência total: 3,8W  
Material: alumínio/policarbonato (PC)

- Classe de proteção IP55 apenas para montagem com emissão da luz para baixo.



Down 170lm | 3000K

Variante	Art. n.º	EUR
● Antracite	231015	118,00
○ Branco	231010	118,00
● Cinzento	231012	118,00

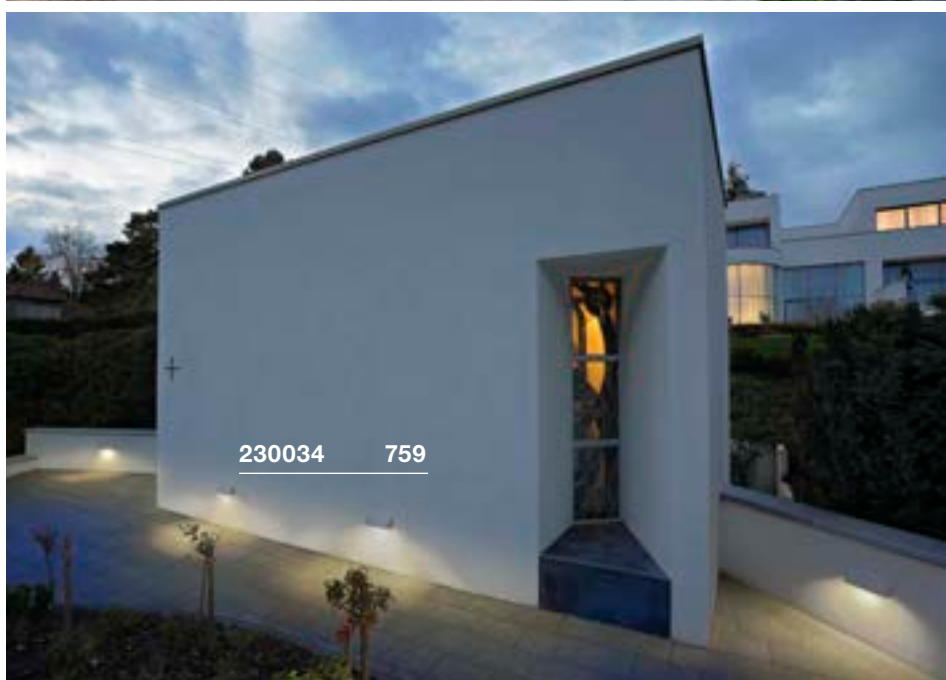



PEMA®  
WL

PEMA®  
WL

PEMA®  
WL, E27

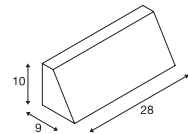
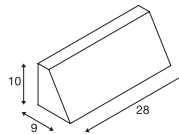
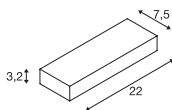

220-240V ~50/60Hz  
Potência total: 7,7W  
Material: alumínio/vidro



100-277V ~50/60Hz | 350mA  
Potência total: 14W  
Material: alumínio/vidro

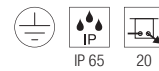

220-240V ~50/60Hz  
Material: alumínio/vidro



Down 640lm | 3000K



Down 1340lm | 3000K | 1420lm | 4000K



Casquilho: 1xE27 Máx. Ø: 4,5 cm | C: 21 cm

Variante	Art. n.º	EUR
● Antracite	1002069	131,00
○ Branco	1002070	131,00

Variante	Art. n.º	EUR
● Preto	1003453	147,00
● Cinzento	1003454	147,00

Variante	Art. n.º	EUR
● Preto	230030	106,00
● Cinzento	230034	106,00



LED E27 | 8W | 240°  
3000K | 880lm | EE=E  
8kWh/1000h



Art. N.º: 1005289 | 10,25 EUR

## FLATT SENSOR WL

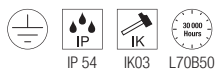
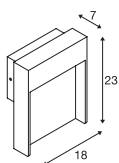

100-240V ~50/60Hz | 300mA  
Potência total: 13W  
Material: alumínio/alumínio



Down 500lm | 3000K | 550lm | 4000K

Variante	Art. n.º	EUR
● Antracite 500 / 530lm	1002954	211,00
●● antracite/castanho 500 / 550lm	1002955	211,00

## FLATT WL

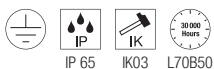
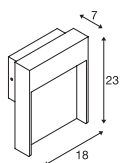

100-240V ~50/60Hz | 300mA  
Potência total: 13W  
Material: alumínio/alumínio



Down 500lm | 3000K | 530lm | 4000K

Variante	Art. n.º	EUR
● Antracite 500 / 530lm	1002952	171,00
●● antracite/castanho 500 / 550lm	1002953	171,00







1002955 760



ASTINA  
WL, QPAR51

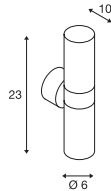

220-240V ~50/60Hz  
Material: alumínio/vidro



Casquilho: 2xGU10 Máx. C: 9 cm

Variante	Art. n.º	EUR
● Antracite	228775	83,00
○ Branco	228771	83,00
● Alumínio	228776	88,00



LED GU10 51mm | 6W | 38°  
2700K | 450lm | EE=F  
6kWh/1000h

Art. N.º: 1005075 | 7,50 EUR



220-240V ~50/60Hz  
Material: aço inoxidável 304



Casquilho: 2xGU10 Máx. Ø: 5,1 cm | C: 5,7 cm

Variante	Art. n.º	EUR
● Aço inoxidável	233302	124,00



LED GU10 51mm | 6W | 38°  
2700K | 450lm | EE=F  
6kWh/1000h

Art. N.º: 1005075 | 7,50 EUR

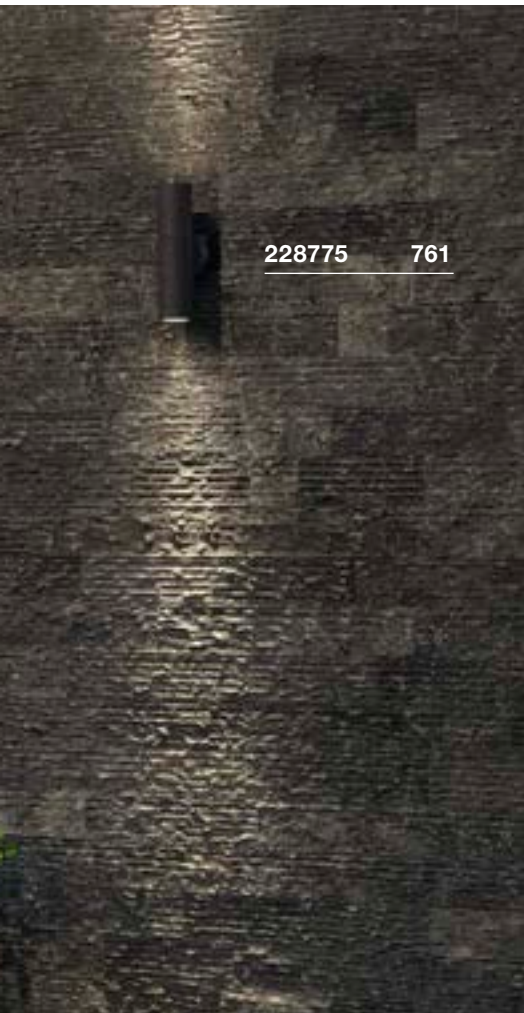

228775 761

# ANGOLUX SENSOR WL

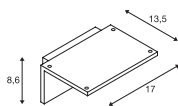

100-240V ~50/60Hz | 240mA  
 Potência total: 9,8W  
 Material: alumínio

- Ângulo de deteção de 120°, distância máxima de deteção de 9 m, sensibilidade de resposta
- Classe de proteção IP44 apenas para montagem com emissão da luz para baixo.



Down 750lm | 3000K

Variante	Art. n.º	EUR
● Antracite	1001969	181,00
○ Branco	1001970	181,00

# ANGOLUX WL

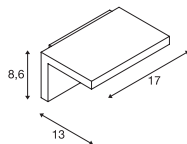

220-240V ~50/60Hz | 80mA  
 Potência total: 6,8W  
 Material: alumínio

- Classe de proteção IP44 apenas para montagem com emissão da luz para baixo.



Down 550lm | 3000K

Variante	Art. n.º	EUR
● Antracite	231355	161,00
○ Branco	231351	161,00

1001969 762

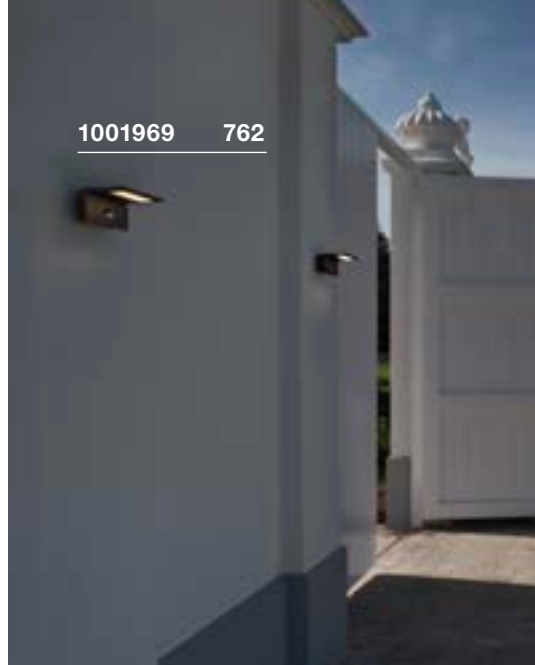

1002504 763

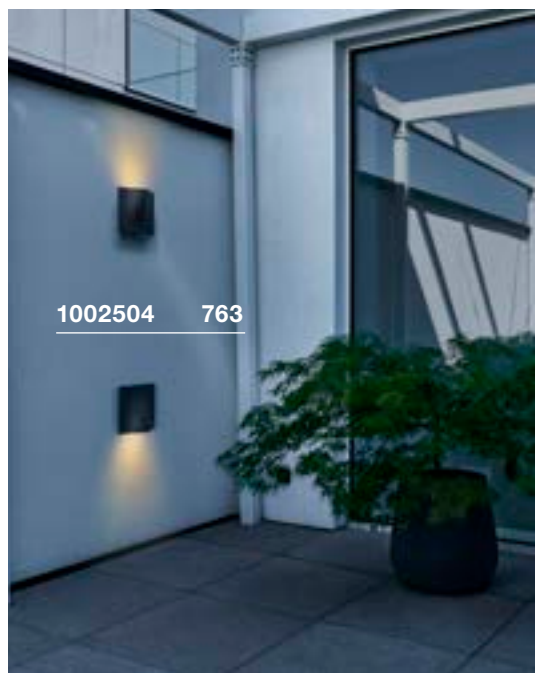

1002505 763





VILUA S  
WL

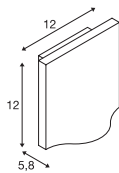

100-277V ~50/60Hz | 700mA  
Potência total: 9W  
Material: alumínio/vidro



Down 405lm | 3000K

Variante	Art. n.º	EUR
● Antracite	1002503	157,00

VILUA L  
WL

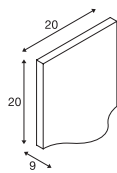

100-277V ~50/60Hz | 350mA  
Potência total: 17W  
Material: alumínio/vidro



Down 940lm | 3000K

Variante	Art. n.º	EUR
● Antracite	1002504	206,00

VILUA  
UP/DOWN, WL

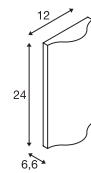

100-277V ~50/60Hz | 700mA  
Potência total: 16W  
Material: alumínio/vidro



Up 400lm | 3000K  
Down 400lm | 3000K

Variante	Art. n.º	EUR
● Antracite	1002505	206,00

MYRA UP/DOWN  
WL, QPAR51

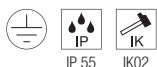
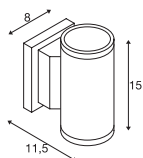

220-240V ~50/60Hz  
Material: alumínio/vidro



Casquilho: 2xGU10 Máx. Ø: 5,1 cm | C: 5,7 cm

Variante	Art. n.º	EUR
● Antracite	233115	99,00
● Cinzento	233114	99,00



LED GU10 51mm | 6W | 38°  
2700K | 450lm | EE=F  
6kWh/1000h



Art. N.º: 1005077 | 7,50 EUR



Artigo	Art. n.º	EUR
Montagem saliente da armação		
● Antracite	233215	21,75
● Cinzento	233214	21,75

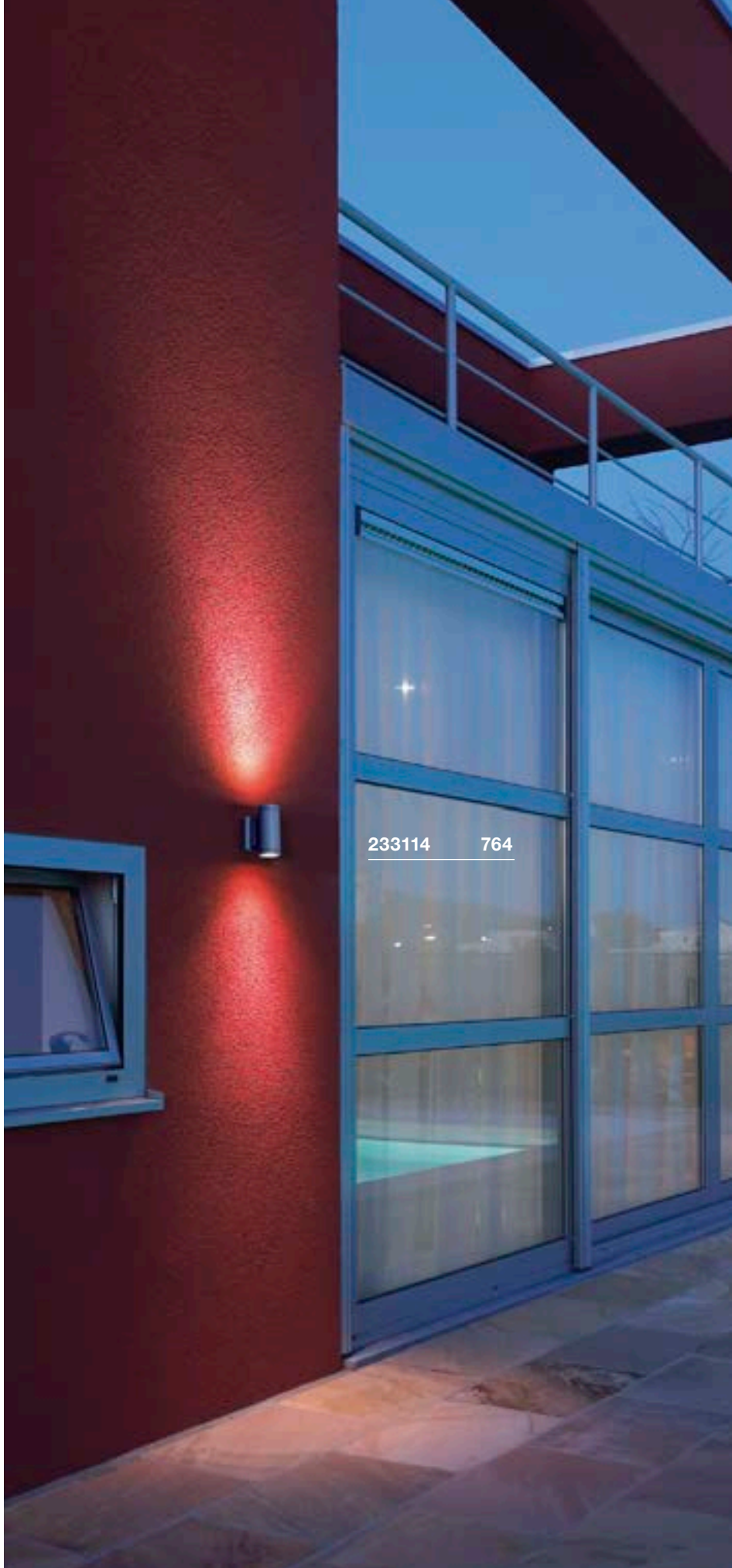

233114 764



SITRA UP/DOWN  
WL

SITRA UP/DOWN  
WL, TCR-TSE

230362 765

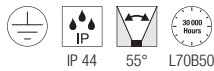
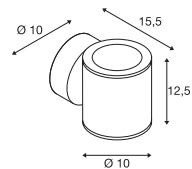
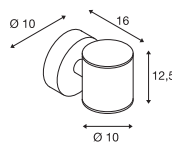

IP 44 55° L70B50

220-240V ~50/60Hz  
Potência total: 18W  
Material: alumínio/vidro



IP 44

220-240V ~50/60Hz  
Material: alumínio/vidro



Up 488lm | 3000K  
Down 488lm | 3000K



Casquilho: 2xGX53 Máx. Ø: 7,5 cm | C: 3,5 cm

Variante	Art. n.º	EUR
● Antracite	1002018	151,00

Variante	Art. n.º	EUR
● Antracite	230365	100,00



LED GX53 | 6,1W | 120°  
3000K | 490lm | EE=G  
6kWh/1000h



Art. N.º: 1005271 | 11,50 EUR



1000334 767



ROX  
WL, QPAR111

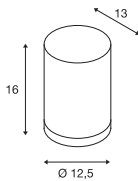

220-240V ~50/60Hz  
Material: alumínio/vidro



Casquilho: 1xGU10

Variante	Art. n.º	EUR
● Alumínio	1000333	151,00



QPAR111 | 12,5W | 10°  
3000K | 950lm | EE=F  
13kWh/1000h



Art. N.º: 1005278 | 55,00 EUR

ROX UP/DOWN  
WL, QPAR111

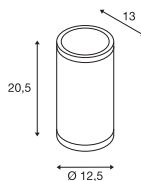

220-240V ~50/60Hz  
Material: alumínio/vidro



Casquilho: 2xGU10

Variante	Art. n.º	EUR
● Alumínio	1000334	191,00



QPAR111 | 12,5W | 10°  
3000K | 950lm | EE=F  
13kWh/1000h



Art. N.º: 1005278 | 55,00 EUR

DELWA  
WL

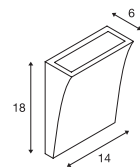

220-240V ~50/60Hz | 700mA  
Potência total: 10W  
Material: alumínio/vidro



Down

840lm | 3000K

Variante	Art. n.º	EUR
● Antracite	1000342	212,00
○ Branco	1000340	212,00

SLOTS  
WL

WALLYX  
WL, QPAR51

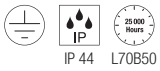
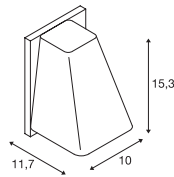
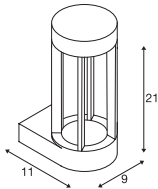

220-240V ~50/60Hz  
Potência total: 4,5W  
Material: alumínio/vidro



220-240V ~50/60Hz  
Material: alumínio/vidro



Down 140lm | 3000K



Casquilho: 1xGU10 Máx. C: 7,6 cm

Variante	Art. n.º	EUR
● Antracite	231805	171,00
● Oxidado	231807	171,00

Variante	Art. n.º	EUR
● Antracite	227195	119,00



LED GU10 51mm | 6W | 38°  
2700K | 450lm | EE=F  
6kWh/1000h



Art. N.º: 1005077 | 7,50 EUR

227195

768

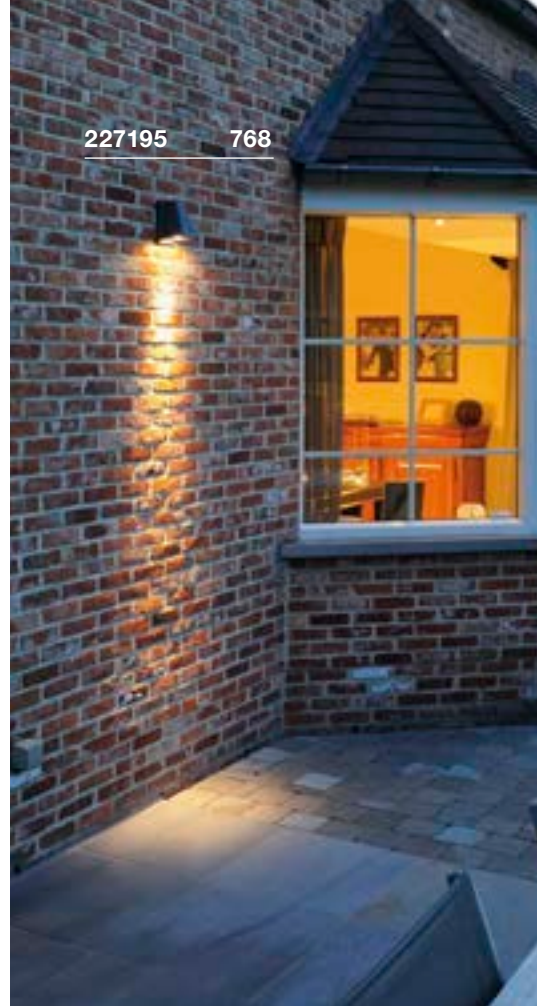





### DOWNUNDER OUT WL, Redondo

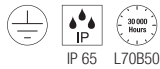
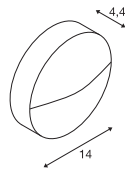

100-240V ~50/60Hz | 500mA  
Potência total: 4,3W  
Material: alumínio



Down 150lm | 3000K | 160lm | 4000K

Variante	Art. n.º	EUR
● Antracite	1002868	134,00

### DOWNUNDER OUT WL, Quadrado

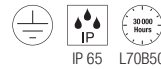
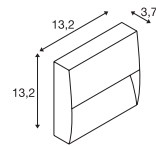

100-240V ~50/60Hz | 500mA  
Potência total: 4,3W  
Material: alumínio



Down 150lm | 3000K | 160lm | 4000K

Variante	Art. n.º	EUR
● Antracite	1002869	134,00

1002868 769

## ABRIDOR SENSOR WL

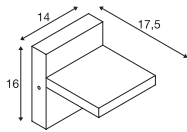

100-240V ~50/60Hz | 300mA  
Potência total: 12W  
Material: alumínio



Down 950lm | 3000K | 980lm | 4000K

Variante	Art. n.º	EUR
● Antracite	1002990	201,00

## ABRIDOR WL

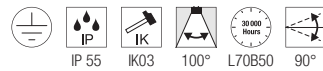
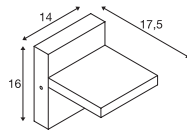

100-240V ~50/60Hz | 300mA  
Potência total: 12W  
Material: alumínio



Down 950lm | 3000K | 980lm | 4000K

Variante	Art. n.º	EUR
● Antracite	1002989	181,00

1002990 770



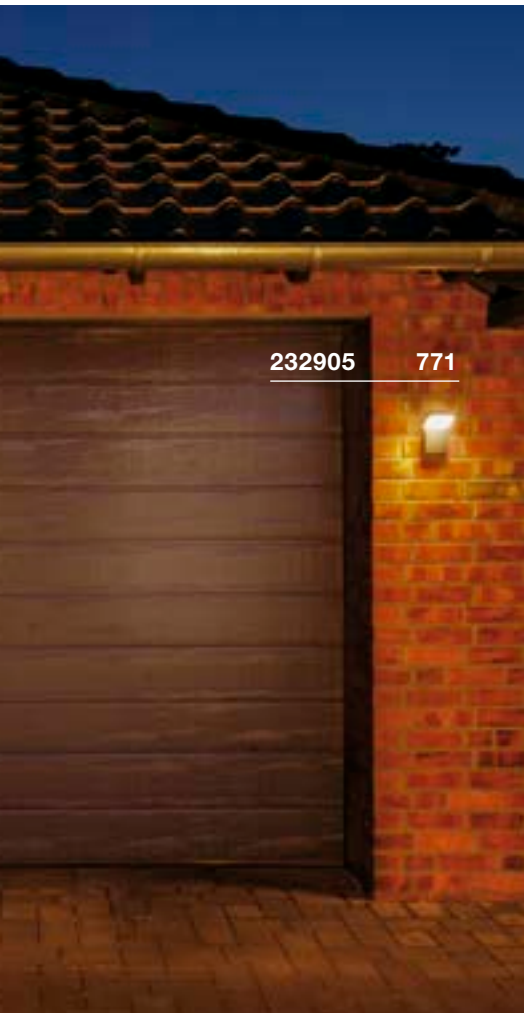

232905

771

## ORDI SENSOR WL

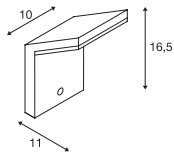

220-240V ~50/60Hz | 110mA  
Potência total: 9W  
Material: alumínio



Down

740lm | 3000K

Variante	Art. n.º	EUR
● Antracite	232915	151,00

## ORDI WL

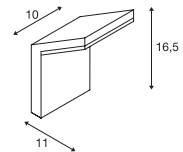

220-240V ~50/60Hz | 110mA  
Potência total: 9W  
Material: alumínio



Down

740lm | 3000K

Variante	Art. n.º	EUR
● Antracite	232905	131,00



232495

773



1002035

773



232485

773



**BOX-L**  
WL, E27

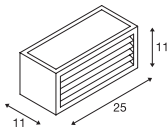

220-240V ~50/60Hz  
Material: alumínio/acrílico



Casquilho: 1xE27 Máx. Ø: 6 cm | C: 17,5 cm

Variante	Art. n.º	EUR
● Antracite	232495	104,00
○ Branco	232491	104,00
● Oxidado	232497	104,00



LED E27 | 8W | 240°  
3000K | 880lm | EE=E  
8kWh/1000h



Art. N.º: 1005289 | 10,25 EUR

**BOX-L**  
WL

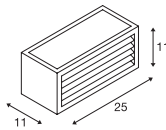

100-277V ~50/60Hz | 500mA  
Potência total: 19W  
Material: alumínio/acrílico



Down 600lm | 3000K

Variante	Art. n.º	EUR
● Antracite	1002035	128,00

**BOX UP/DOWN**  
WL, QT-DE12

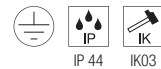
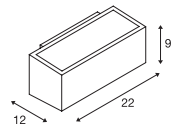

220-240V ~50/60Hz  
Material: alumínio



Casquilho: 1xR7s 78 mm

Variante	Art. n.º	EUR
● Antracite	232485	100,00



LED R7s | 9W | 330°  
3000K | 1050lm | EE=E  
9kWh/1000h



Art. N.º: 1005287 | 24,00 EUR



232101 775

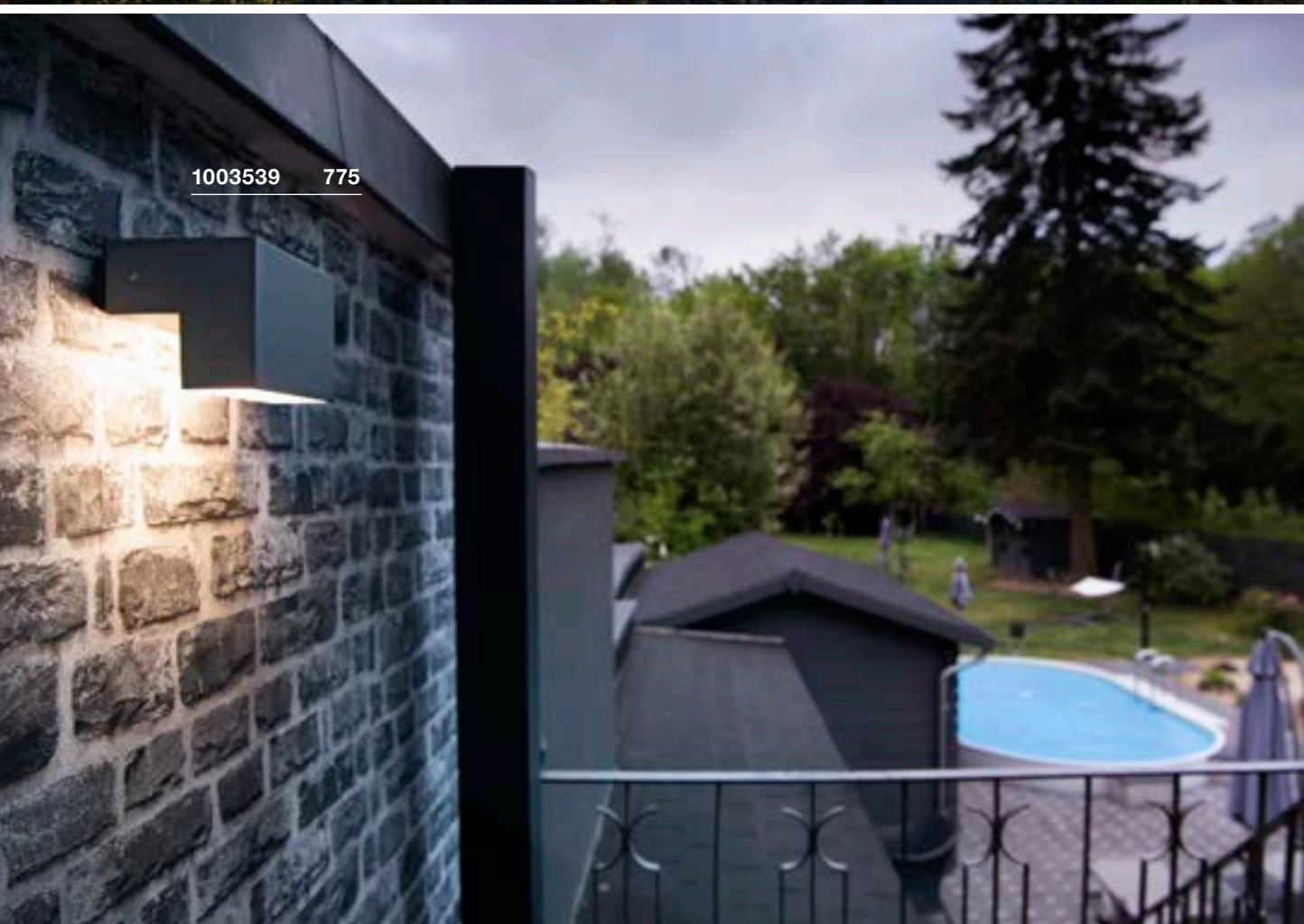

1003539 775



LOGS  
WL

OUT-BEAM UP /  
FLOOD DOWN  
WL

L-LINE OUT  
WL

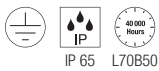
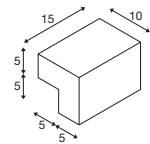
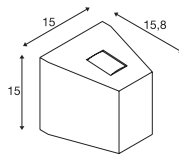
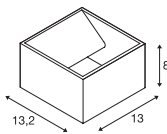

220-240V ~50/60Hz | 500mA  
Potência total: 9,5W  
Material: alumínio



220-240V ~50/60Hz | 500mA  
Potência total: 18W  
Material: alumínio/vidro

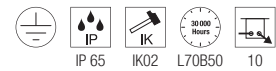

220-240V ~50/60Hz | 350mA  
Potência total: 7W  
Material: alumínio/policarbonato (PC)



Down 520lm | 3000K  
800lm



Up 50lm | 3000K  
Down 690lm | 3000K



Down 500lm | 3000K | 570lm | 4000K

Variante	Art. n.º	EUR
● Antracite		
520lm	<b>232105</b>	<b>200,00</b>
○ Branco		
800lm	<b>232101</b>	<b>200,00</b>

Variante	Art. n.º	EUR
● Antracite	<b>229665</b>	<b>274,00</b>
● Cinzento	<b>229664</b>	<b>274,00</b>

Variante	Art. n.º	EUR
● Antracite	<b>1003539</b>	<b>141,00</b>

232045 777







PHOTONIA  
WL, E27

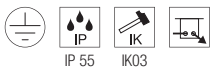
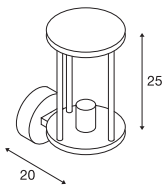

220-240V ~50/60Hz  
Material: alumínio/vidro



Casquilho: 1xE27 Máx. Ø: 9 cm C: 15 cm

Variante	Art. n.º	EUR
● Antracite	232045	189,00



LED E27 | 7,5W | 320°  
2500K | 700lm | EE=F  
8kWh/1000h



Art. N.º: 1005265 | 26,50 EUR



Artigo	Art. n.º	EUR
Espaçador		
● Antracite	1002853	7,75

MOLAT  
WL, E27

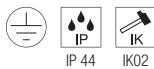
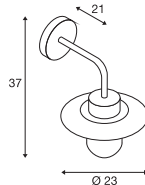

220-240V ~50/60Hz  
Material: alumínio/vidro



Casquilho: 1xE27 Máx. Ø: 6,5 cm C: 14,5 cm

Variante	Art. n.º	EUR
● Antracite	1000820	106,00



A60 | 7,5W | 320°  
2700K | 800lm | EE=F  
8kWh/1000h



Art. N.º: 1005303 | 9,60 EUR

GLOO PURE  
WL, E27

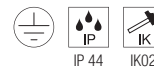
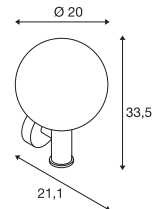

220-240V ~50/60Hz  
Material: alumínio/vidro



Casquilho: 1xE27 Máx. Ø: 4,8 cm C: 18 cm

Variante	Art. n.º	EUR
● Antracite	1002002	97,00



LED E27 | 8W | 240°  
4000K | 920lm | EE=E  
8kWh/1000h



Art. N.º: 1005290 | 10,25 EUR



1000336 779

F-POL  
WL, E27

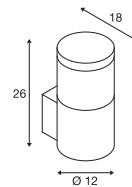

230355 779

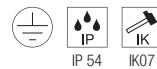

220-240V ~50/60Hz  
Material: alumínio/policarbonato (PC)

**SOCKET**  
**INSIDE** <20  
W

Casquilha: 1xE27 Máx. Ø: 5,1 cm | C: 14 cm

Variante	Art. n.º	EUR
● Antracite	231585	141,00



LED E27 | 8W | 240°  
4000K | 920lm | EE=E  
8kWh/1000h



Art. N.º: 1005290 | 10,25 EUR



### SQUARE WL, E27

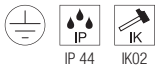
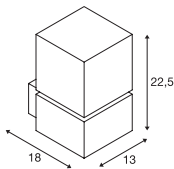

220-240V ~50/60Hz  
Material: aço inoxidável 304



Casquilho: 1xE27 Máx. Ø: 7 cm | C: 13 cm

Variante	Art. n.º	EUR
● Aço inoxidável	1000336	224,00



A60 | 7,5W | 320°  
2700K | 800lm | EE=F  
8kWh/1000h



Art. N.º: 1005303 | 9,60 EUR

### KERAS ELT WL, E27

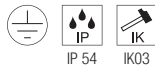
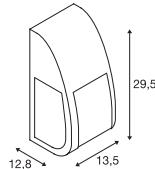

220-240V ~50/60Hz  
Material: alumínio/policarbonato (PC)



Casquilho: 1xE27 Máx. Ø: 7 cm | C: 17,5 cm

Variante	Art. n.º	EUR
● Antracite	227176	162,00



A60 | 7,5W | 320°  
2700K | 800lm | EE=F  
8kWh/1000h



Art. N.º: 1005303 | 9,60 EUR

### SITRA WL, TCR-TSE

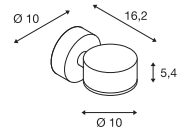

220-240V ~50/60Hz  
Material: alumínio/vidro



Casquilho: 1xGX53 Máx. Ø: 7,5 cm | C: 3,5 cm

Variante	Art. n.º	EUR
● Antracite	230355	70,00



LED GX53 | 6,1W | 120°  
3000K | 490lm | EE=G  
6kWh/1000h



Art. N.º: 1005271 | 11,50 EUR

RASCALI  
WL

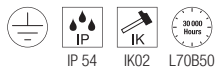
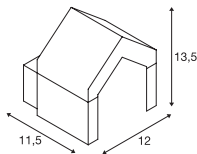

220-240V ~50/60Hz  
Potência total: 8W  
Material: alumínio



Down 330lm | 3000K

Variante	Art. n.º	EUR
● Antracite	1000797	133,00

IPERI  
WL

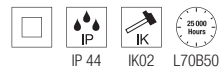
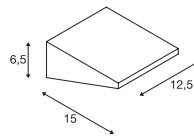

220-240V ~50/60Hz  
Potência total: 4,5W  
Material: alumínio

- Classe de proteção IP44 apenas para montagem com emissão da luz para baixo.



Down 400lm | 4000K

Variante	Art. n.º	EUR
● Preto	231315	129,00

1000797 780





231315 781

QUADRASYL  
WL, TCR-TSE

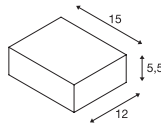

220-240V ~50/60Hz  
Material: alumínio/vidro



Casquilho: 1xGX53 Máx. Ø: 7,5 cm C: 2,7 cm

Variante	Art. n.º	EUR
● Antracite	232285	64,00



LED GX53 | 6,1W | 120°  
3000K | 490lm | EE=G  
6kWh/1000h



Art. N.º: 1005271 | 11,50 EUR

SQUARE TURN  
WL, G9

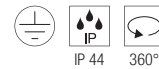
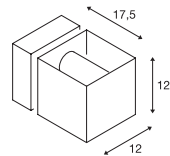

220-240V ~50/60Hz  
Material: alumínio/vidro



Casquilho: 1xG9 Máx. Ø: 3,5 cm C: 8 cm

Variante	Art. n.º	EUR
● Cinzento	1000335	211,00



LED G9 | 3,6W | 300°  
3000K | 400lm | EE=E  
4kWh/1000h



Art. N.º: 1005286 | 9,99 EUR



1000335 781

1002905 783



233134 783





### TODAY PRO Display

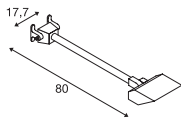

220-240V ~50/60Hz | 640mA  
Potência total: 29W  
Material: alumínio



Down 2800lm | 4000K

Variante	Art. n.º	EUR
● Preto	1000880	228,00
○ Branco	1000881	228,00

### ESKINA D Display, PHASE

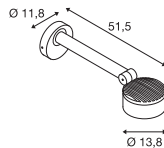

220-240V ~50/60Hz | 350mA  
Potência total: 14,5W  
Material: alumínio

- Interruptor CCT na cabeça da luminária



Down 1000lm | 3000K | 1000lm | 4000K

Variante	Art. n.º	EUR
● Antracite	1002905	272,00

### MYRA DISPLAY WL, curved, QPAR51

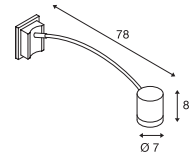

220-240V ~50/60Hz  
Material: alumínio



Casquilho: 1xGU10 Máx. Ø: 5,1 cm | C: 5,7 cm

Variante	Art. n.º	EUR
● Antracite	233135	179,00
● Cinzento	233134	179,00



LED GU10 51mm | 6W | 38°  
2700K | 450lm | EE=F  
6kWh/1000h



Art. N.º: 1005077 | 7,50 EUR



Artigo	Art. n.º	EUR
Montagem saliente da armação		
● Antracite	233215	21,75
● Cinzento	233214	21,75

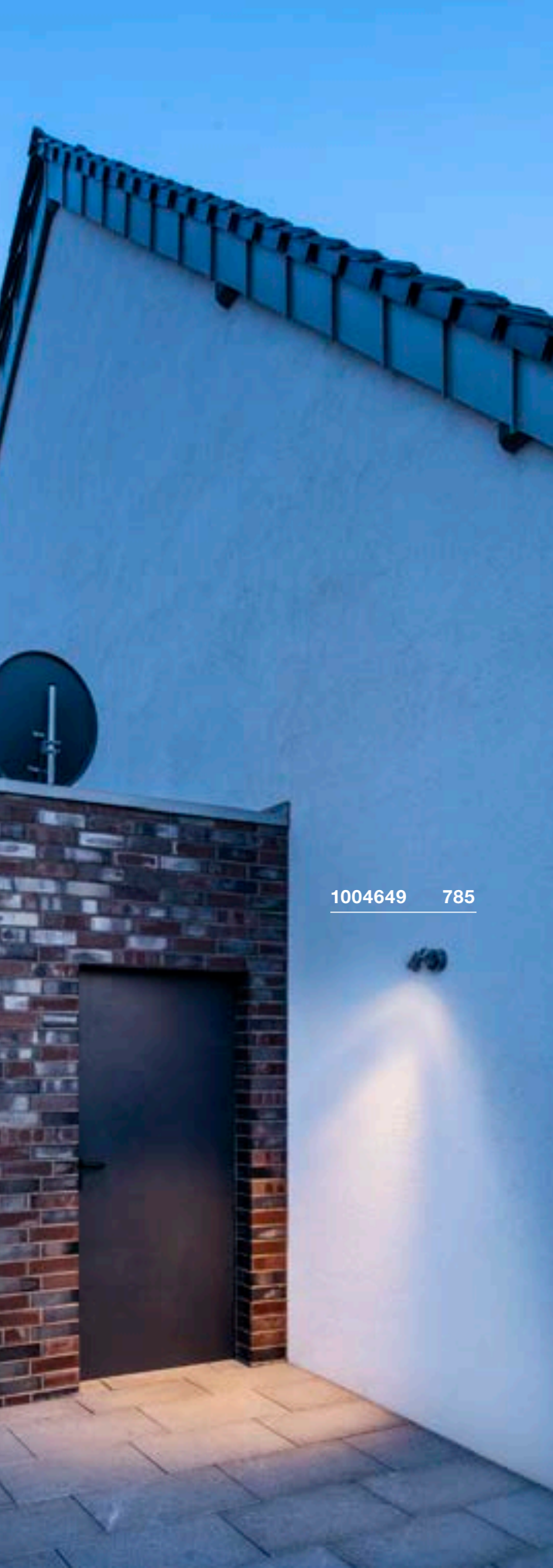

1004649 785

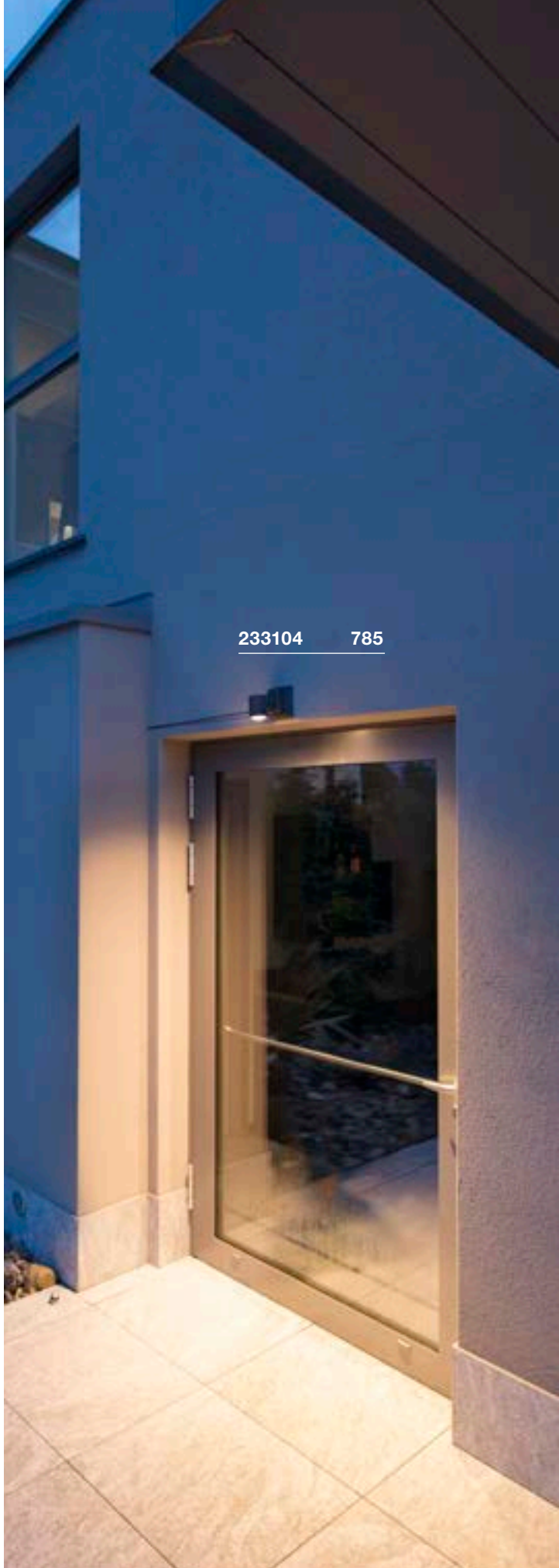

233104 785





LED SPOT  
SP

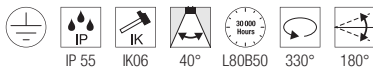
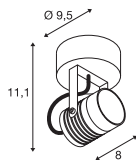

100-240V ~50/60Hz | 240mA  
Potência total: 6W  
Material: alumínio/vidro



Down 400lm | 3000K

Variante	Art. n.º	EUR
● Antracite	1004649	72,00
● Oxidado	1004957	72,00

NAUTILUS  
WL QPAR51

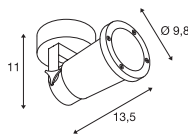

220-240V ~50/60Hz  
Material: alumínio



Casquilho: 1xGU10 Máx. Ø: 5,1 cm | C: 8,3 cm

Variante	Art. n.º	EUR
● Preto	1002867	49,00



LED GU10 51mm | 6W | 38°  
2700K | 450lm | EE=F  
6kWh/1000h



Art. N.º: 1005077 | 7,50 EUR



Artigo	Art. n.º	EUR
NAUTILUS   Placa de montagem		
● Preto	1002884	5,40

MYRA  
CW, single, QPAR51

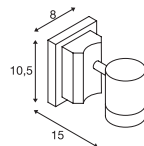

220-240V ~50/60Hz  
Material: alumínio/vidro



Casquilho: 1xGU10 Máx. Ø: 5,1 cm | C: 5,7 cm

Variante	Art. n.º	EUR
● Antracite	233105	89,00
● Cinzento	233104	89,00



LED GU10 51mm | 6W | 38°  
2700K | 450lm | EE=F  
6kWh/1000h



Art. N.º: 1005077 | 7,50 EUR



Artigo	Art. n.º	EUR
Montagem saliente da armação		
● Antracite	233215	21,75
● Cinzento	233214	21,75

1003427 793





**SCKET**  
PHOTONI | 789



**LED**  
S-CUBE | 791



**LED**  
ESKINA FRAME | 791



**LED**  
ENOLA OCULUS | 792



**LED**  
ENOLA ROUND S | 793



**LED**  
ENOLA ROUND M | 793



**LED**  
ENOLA ROUND L | 793



**LED**  
ENOLA SQUARE S | 795



**LED**  
ENOLA SQUARE M | 795



**LED**  
ENOLA SQUARE L | 795



**LED**  
BIG THEO | 797



**SCKET**  
BIG THEO | 797



**LED**  
OVALISK | 797



**SCKET**  
PHOTONIA | 799



**SCKET**  
MOLAT | 799



**SCKET**  
SITRA | 801



**SCKET**  
ROX | 801



**SCKET**  
ROX | 801

1007586 789

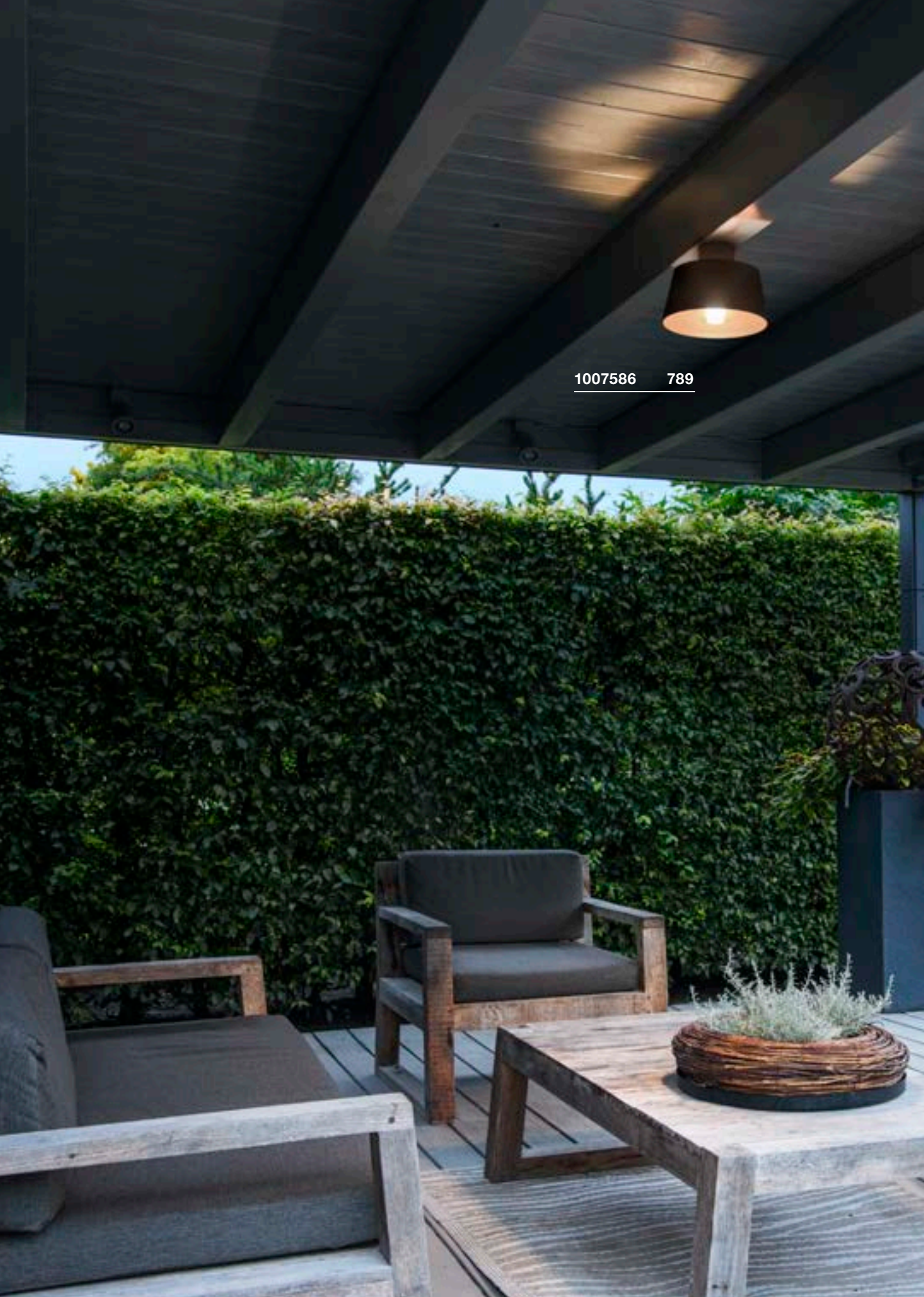

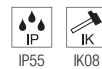
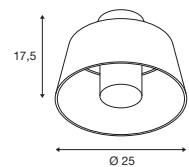
PHOTONI  
CL, E27

220-240V ~50/60Hz  
Material: alumínio

- Resistente a ambientes salínicos

**SOCKET**  
**INSIDE** 13  
W

Casquilho: 1xE27

Máx. Ø: 6 cm

C: 11,6 cm

Variante	Art. n.º	EUR
● Preto	1007586	99,00
● Oxidado	1007582	99,00



LED E27 | 8W | 240°  
3000K | 880lm | EE=E  
8kWh/1000h



Art. N.º: 1005289 | 10,25 EUR

1007461 791





### S-CUBE CL

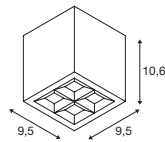

220-240V ~50/60Hz | 350mA  
Potência total: 15W  
Material: alumínio



Down 1000lm | 2700K | 1200lm | 3000K

Variante	Art. n.º	EUR
● Antracite	1007461	● 134,00

### ESKINA FRAME CL, single

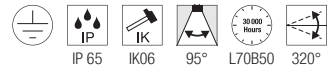
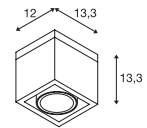

220-240V ~50/60Hz | 350mA  
Potência total: 15W  
Material: alumínio/vidro



Down 1100lm | 3000K | 1200lm | 4000K

Variante	Art. n.º	EUR
● Antracite	1006316	183,00

# ENOLA OCULUS CL

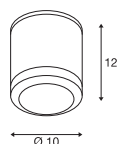

220-240V ~50/60Hz | 500mA  
Potência total: 11W  
Material: alumínio/vidro



Down 1000lm | 3000K | 1100lm | 4000K

Variante	Art. n.º	EUR
● Antracite	1006327	239,00



Artigo	Art. n.º	EUR
Espaçador		
● Antracite	1003479	9,05



1006327 792





### ENOLA ROUND S CL

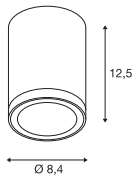

220-240V ~50/60Hz | 500mA  
Potência total: 9W  
Material: alumínio/vidro

Down	540lm   3000K   610lm   4000K

Variante	Art. n.º	EUR
● Antracite	1003426	172,00



Artigo	Art. n.º	EUR
Espaçador		
● Antracite	1003479	9,05
Refletor 60°		
● Cromado	1005262	16,40

### ENOLA ROUND M CL

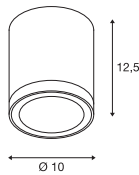

220-240V ~50/60Hz | 500mA  
Potência total: 11W  
Material: alumínio/vidro

Down	840lm   3000K   960lm   4000K

Variante	Art. n.º	EUR
● Antracite	1003427	219,00



Artigo	Art. n.º	EUR
Espaçador		
● Antracite	1003479	9,05
Lente de 19°		
● Preto	1005205	41,75
Lente assimétrica		
● Preto/cromado	1005206	41,75
Refletor 60°		
● Cromado	1005207	24,75

### ENOLA ROUND L CL

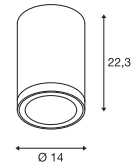

220-240V ~50/60Hz | 900mA  
Potência total: 36W  
Material: alumínio/vidro

Down	3200lm   3000K   3500lm   4000K

Variante	Art. n.º	EUR
● Antracite	1003442	312,00



Artigo	Art. n.º	EUR
Espaçador		
● Antracite	1003479	9,05
Refletor 60°		
● Cromado	1005263	21,50

1003421 795





## ENOLA SQUARE S CL

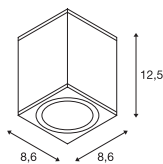

220-240V ~50/60Hz | 500mA  
Potência total: 9W  
Material: alumínio/vidro



Down 540lm | 3000K | 610lm | 4000K

Variante	Art. n.º	EUR
● Antracite	1003420	172,00



Artigo	Art. n.º	EUR
Espaçador		
● Antracite	1003479	9,05
Refletor 60°		
● Cromado	1005262	16,40

## ENOLA SQUARE M CL

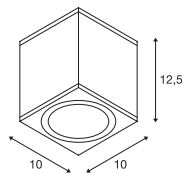

220-240V ~50/60Hz | 500mA  
Potência total: 11W  
Material: alumínio/vidro



Down 840lm | 3000K | 960lm | 4000K

Variante	Art. n.º	EUR
● Antracite	1003421	219,00



Artigo	Art. n.º	EUR
Espaçador		
● Antracite	1003479	9,05
Lente de 19°		
● Preto	1005205	41,75
Lente assimétrica		
● Preto/cromado	1005206	41,75
Refletor 60°		
● Cromado	1005207	24,75

## ENOLA SQUARE L CL

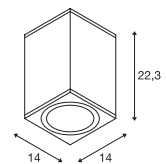

220-240V ~50/60Hz | 900mA  
Potência total: 36W  
Material: alumínio/vidro



Down 3200lm | 3000K | 3500lm | 4000K

Variante	Art. n.º	EUR
● Antracite	1003439	312,00



Artigo	Art. n.º	EUR
Espaçador		
● Antracite	1003479	9,05
Refletor 60°		
● Cromado	1005263	21,50





## BIG THEO CL

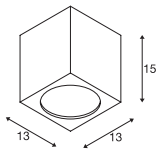

100-277V ~50/60Hz | 500mA  
Potência total: 21W  
Material: alumínio/vidro



Down 2000lm | 3000K

Variante	Art. n.º	EUR
● Antracite	234535	209,00

## BIG THEO CL, QPAR111

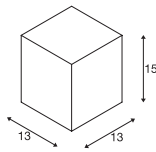

220-240V ~50/60Hz  
Material: alumínio/vidro



Casquilho: 1xGU10

Variante	Art. n.º	EUR
● Antracite	229555	124,00
○ Branco	229551	124,00
● Cinzento	229554	124,00



QPAR111 | 12,5W | 10°  
3000K | 950lm | EE=F  
13kWh/1000h

Art. N.º: 1005278 | 55,00 EUR



## OVALISK CL

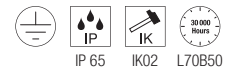
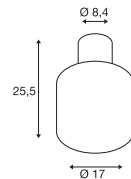

220-240V ~50/60Hz | 350mA  
Potência total: 7,9W  
Material: alumínio/vidro



Down 540lm | 3000K | 570lm | 4000K

Variante	Art. n.º	EUR
● Antracite	1004677	272,00

232055 799

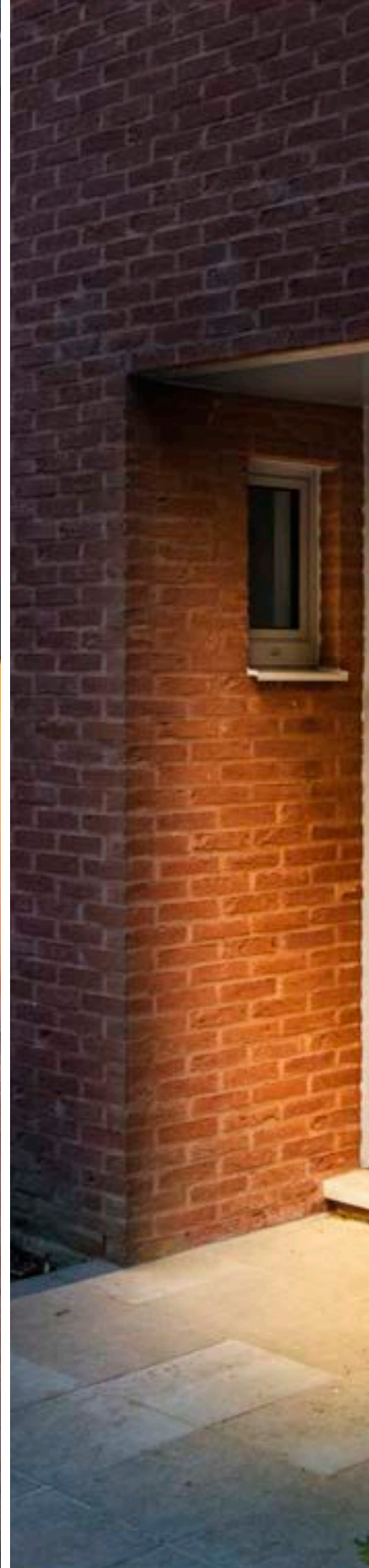



PHOTONIA  
CL, E27

MOLAT  
CL, E27

1000823 799

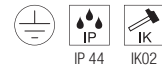
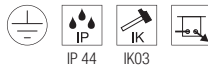
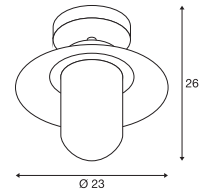
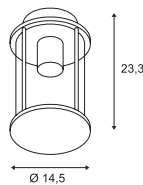

220-240V ~50/60Hz  
Material: alumínio/vidro

220-240V ~50/60Hz  
Material: alumínio/vidro



Casquilho: 1xE27 Máx. Ø: 9 cm | C: 15 cm

Casquilho: 1xE27 Máx. Ø: 6,5 cm | C: 14,5 cm

Variante	Art. n.º	EUR
● Antracite	232055	206,00

Variante	Art. n.º	EUR
● Antracite	1000823	132,00



LED E27 | 7,5W | 320°  
2500K | 700lm | EE=F  
8kWh/1000h



Art. N.º: 1005265 | 26,50 EUR



LED E27 | 7,5W | 320°  
2500K | 700lm | EE=F  
8kWh/1000h



Art. N.º: 1005265 | 26,50 EUR



Artigo	Art. n.º	EUR
Espaçador		
● Antracite	1002853	7,75

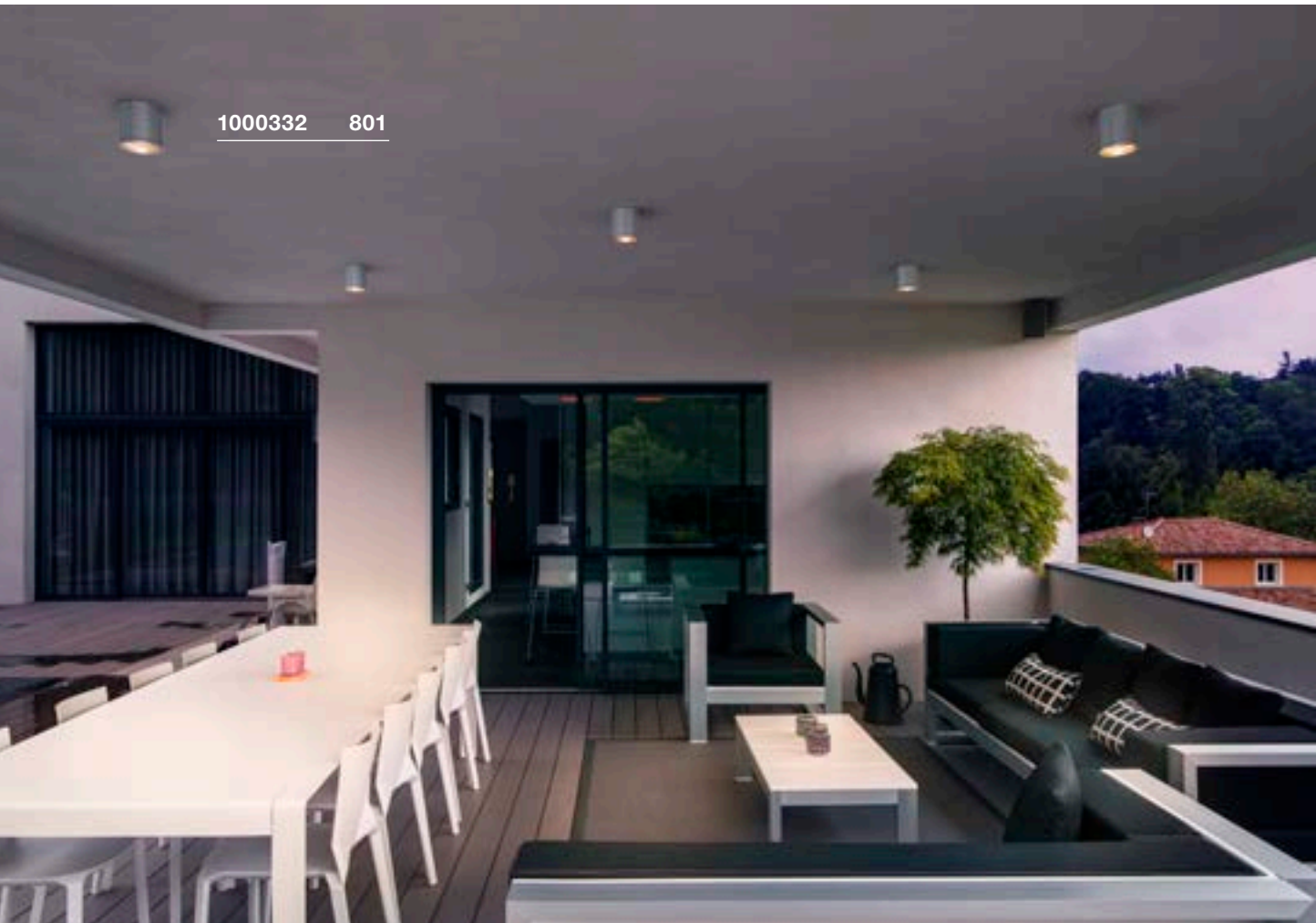





SITRA  
CL, TCR-TSE

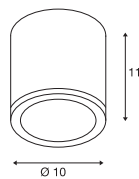

220-240V ~50/60Hz  
Material: alumínio/vidro



Casquilho: 1xGX53 Máx. Ø: 7,5 cm | C: 3,5 cm

Variante	Art. n.º	EUR
● Antracite	231545	90,00
○ Branco	231541	90,00



LED GX53 | 6,1W | 120°  
3000K | 490lm | EE=G  
6kWh/1000h



Art. N.º: 1005271 | 11,50 EUR

ROX  
CL, QPAR111

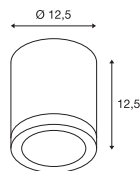

220-240V ~50/60Hz  
Material: alumínio/vidro



Casquilho: 1xGU10

Variante	Art. n.º	EUR
● Alumínio	1000332	131,00



QPAR111 | 12,5W | 10°  
3000K | 950lm | EE=F  
13kWh/1000h



Art. N.º: 1005278 | 55,00 EUR

ROX  
CL, GX53

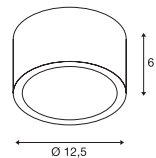

220-240V ~50/60Hz  
Material: alumínio/vidro



Casquilho: 1xGX53 Máx. Ø: 7,5 cm | C: 3,5 cm

Variante	Art. n.º	EUR
● Alumínio/transpa- rente	1000339	161,00



LED GX53 | 6,1W | 120°  
3000K | 490lm | EE=G  
6kWh/1000h



Art. N.º: 1005271 | 11,50 EUR

1005202 811





**LED**  
R-CUBE | 805



**LED**  
S-CUBE | 805



**SCKET**  
S-TUBE | 805



**LED**  
ESKINA SPOT  
SENSOR | 807



**LED**  
ESKINA SPOT | 807



**SCKET**  
SITRA 360 | 808



**SCKET**  
THEO BRACKET | 808



**LED**  
HELIA | 809



**LED**  
HELIA | 809



**SCKET**  
MYRA | 811



**LED**  
OUT-BEAM  
FRAME | 811



**LED**  
QUADRULO | 811



**LED**  
AINOS | 812-813



**LED**  
AINOS | 813



**LED**  
AINOS | 813



**LED**  
RUBA | 814



**SCKET**  
BULAN | 815



**SCKET**  
BULAN GRID | 815



**LED**  
TERANG 200 | 817



**LED**  
IMPERVA | 817



1007511 805

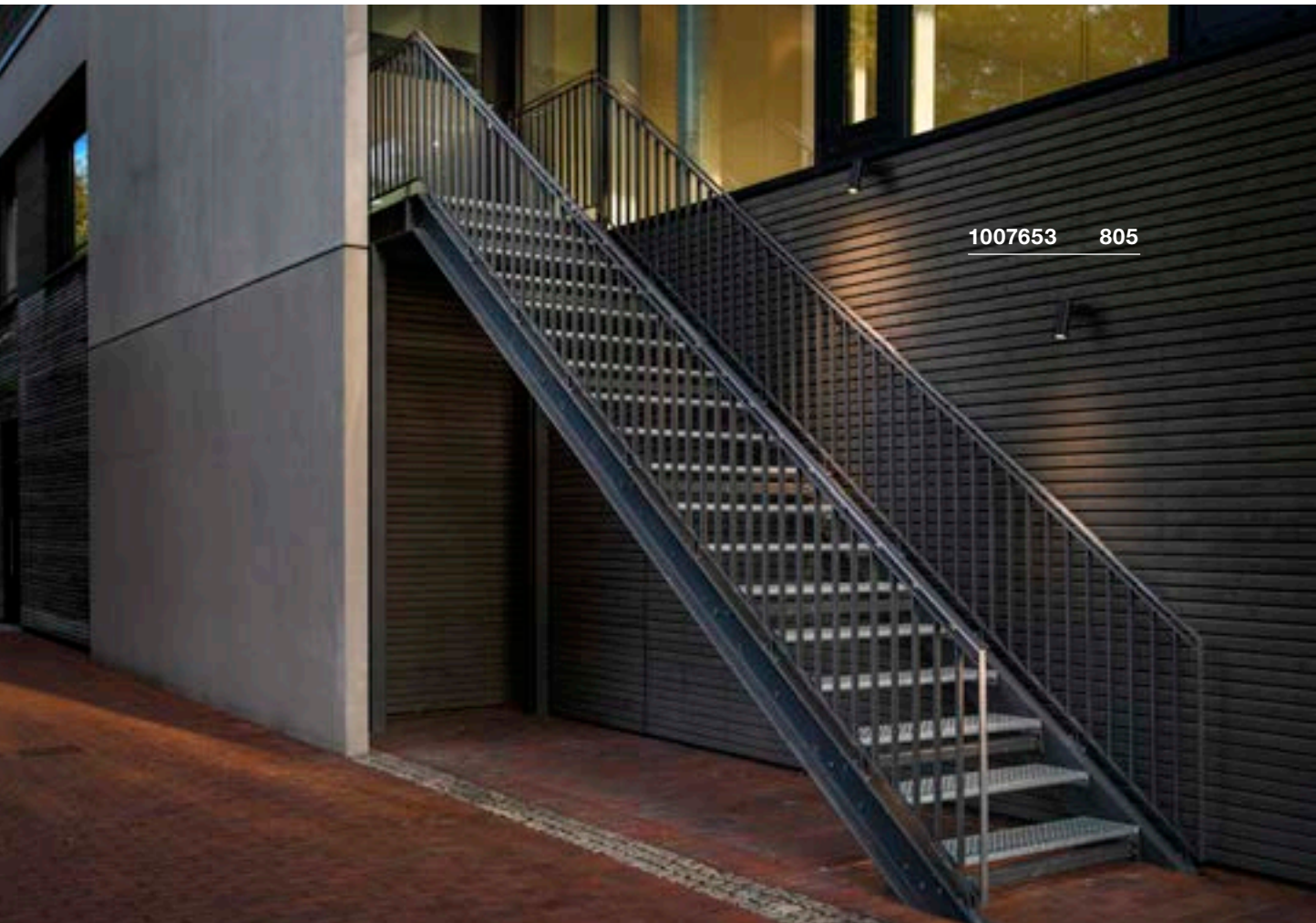

1007653 805



R-CUBE  
CW

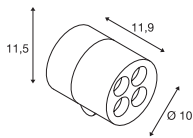

Antracite

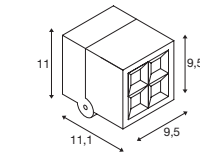

S-TUBE  
CW

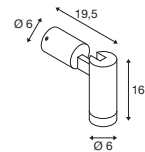

220-240V ~50/60Hz | 350mA  
Potência total: 15W  
Material: alumínio



220-240V ~50/60Hz | 350mA  
Potência total: 15W  
Material: alumínio

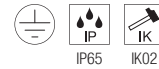

220-240V ~50/60Hz  
Material: alumínio



Down 800lm | 2700K | 800lm | 3000K



Down 1000lm | 2700K | 1200lm | 3000K



Casquilho: 1xGU10 Máx. Ø: 5 cm | C: 5,5 cm

Variante	Art. n.º	EUR
● Antracite	1007511	● 154,00

Variante	Art. n.º	EUR
● Antracite	1007458	● 154,00

Variante	Art. n.º	EUR
● Preto	1007653	● 99,00



LED GU10 51mm | 6W | 38°  
2700K | 450lm | EE=F  
6kWh/1000h



Art. N.º: 1005077 | 7,50 EUR

1002904 807

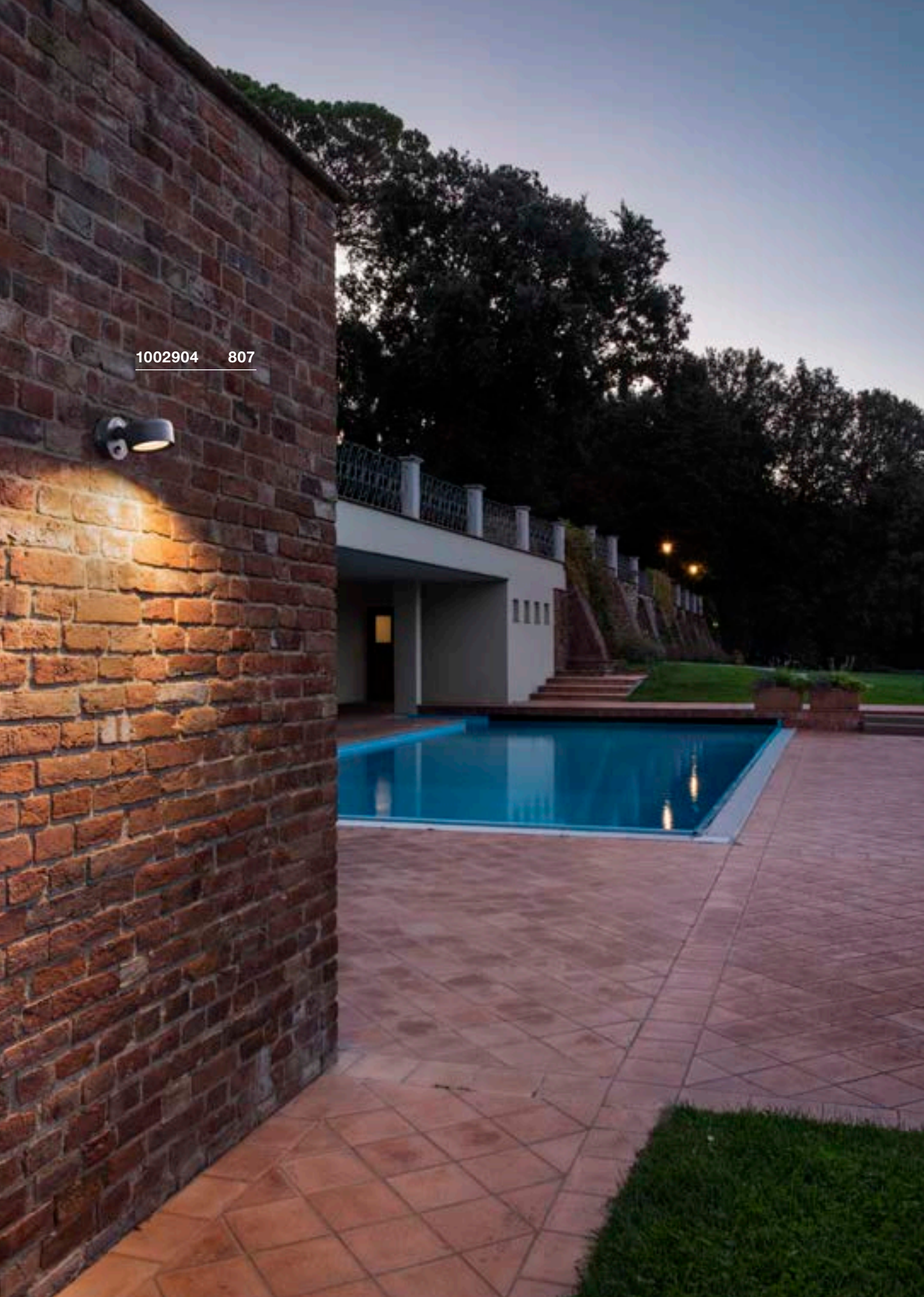



### ESKINA SPOT SENSOR CW, PHASE

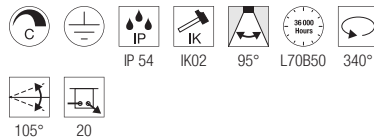
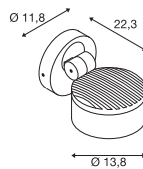

220-240V ~50/60Hz | 350mA  
Potência total: 15W  
Material: alumínio

- Detetor de movimento na roseta de parede.



Down 1000lm | 3000K | 1000lm | 4000K

Variante	Art. n.º	EUR
● Antracite	1002904	272,00

### ESKINA SPOT CW, PHASE

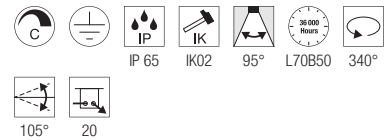
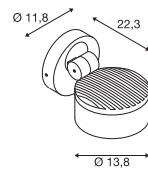

220-240V ~50/60Hz | 350mA  
Potência total: 14,5W  
Material: alumínio



Down 1000lm | 3000K | 1000lm | 4000K

Variante	Art. n.º	EUR
● Antracite	1002903	252,00

SITRA 360  
CW, TCR-TSE

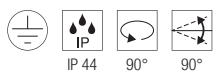
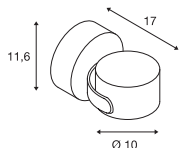

220-240V ~50/60Hz  
Material: alumínio/vidro



Casquilho: 1xGX53 Máx. Ø: 7,5 cm | C: 3,5 cm

Variante	Art. n.º	EUR
● Antracite	231515	109,00



LED GX53 | 6,1W | 120°  
3000K | 490lm | EE=G  
6kWh/1000h



Art. N.º: 1005271 | 11,50 EUR

THEO BRACKET  
CW

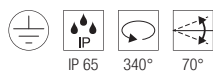
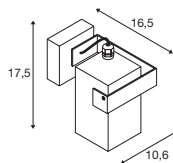

220-240V ~50/60Hz  
Material: alumínio/vidro



Casquilho: 1xGU10 Máx. Ø: 5,1 cm | C: 5,7 cm

Variante	Art. n.º	EUR
● Antracite	1004653	77,00



LED GU10 51mm | 6W | 38°  
2700K | 450lm | EE=F  
6kWh/1000h



Art. N.º: 1005077 | 7,50 EUR



233245 809





1004653 808

HELIA  
CW, single, PHASE

HELIA  
CW, double, PHASE

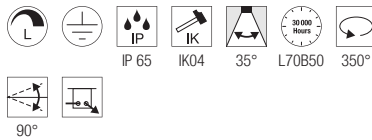
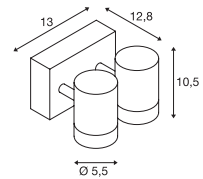
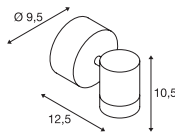

220-240V ~50/60Hz | 500mA  
Potência total: 6,5W  
Material: alumínio/vidro



Down 440lm | 3000K

Variante	Art. n.º	EUR
● Antracite	233245	176,00



Artigo	Art. n.º	EUR
Espaçador		
● Antracite	1002853	7,75

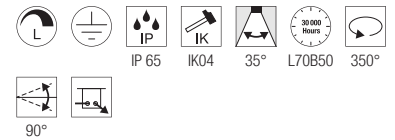

220-240V ~50/60Hz | 500mA  
Potência total: 13W  
Material: alumínio/vidro



Down 880lm | 3000K

Variante	Art. n.º	EUR
● Antracite	233255	309,00



Artigo	Art. n.º	EUR
Espaçador		
● Antracite	1002853	7,75

1003519 811



1005202 811

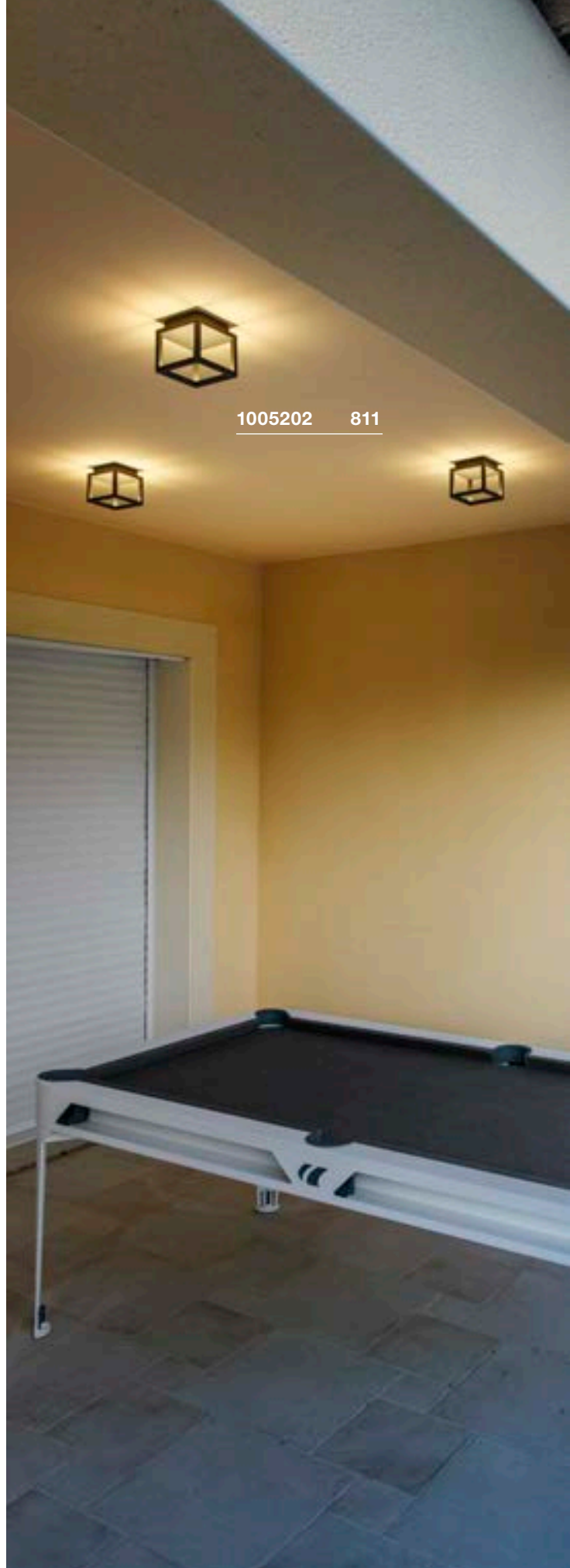



**MYRA**  
WL, double, QPAR51

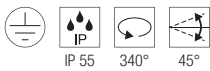
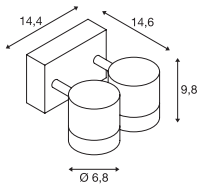

220-240V ~50/60Hz  
Material: alumínio/vidro



Casquilho: 2xGU10 Máx. Ø: 5,1 cm | C: 5,7 cm

Variante	Art. n.º	EUR
● Antracite	233095	169,00
● Cinzento	233094	169,00



LED GU10 51mm | 6W | 38°  
2700K | 450lm | EE=F  
6kWh/1000h



Art. N.º: 1005077 | 7,50 EUR



Artigo	Art. n.º	EUR
Espaçador		
● Antracite	1002853	7,75

**OUT-BEAM FRAME**  
SP

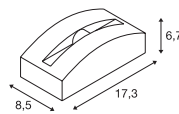

100-240V ~50/60Hz | 700mA  
Potência total: 3,5W  
Material: alumínio/acrílico



Down 60lm | 3000K

Variante	Art. n.º	EUR
● Antracite	1003518	122,00
○ Branco	1003519	122,00

**QUADRULO**  
CL

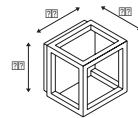

100-277V ~50/60Hz | 480mA  
Potência total: 7,5W  
Material: alumínio/acrílico



Down 230lm | 3000K

Variante	Art. n.º	EUR
● Antracite	1005202	166,00



229971 813

## AINOS CW

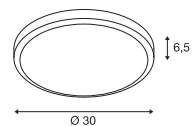

1003452 813

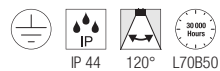

220-240V ~50/60Hz | 500mA  
Potência total: 21W  
Material: alumínio/policarbonato (PC)



Down

1430lm | 3000K

Variante	Art. n.º	EUR
● Antracite	229965	149,00
○ Branco	229961	149,00



### AINOS CW SENSOR

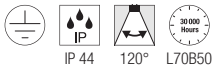
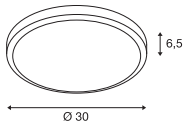

220-240V ~50/60Hz | 500mA  
Potência total: 22W  
Material: alumínio/policarbonato (PC)

- Sensor no corpo da luminária.



Down 1430lm | 3000K

Variante	Art. n.º	EUR
● Antracite	229975	195,00
○ Branco	229971	195,00

### AINOS CW, Quadrado

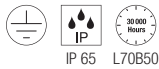
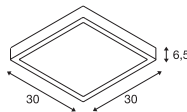

220-240V ~50/60Hz | 500mA  
Potência total: 17W  
Material: alumínio/policarbonato (PC)



Down 1300lm | 3000K | 1300lm | 4000K

Variante	Art. n.º	EUR
● Antracite	1003450	161,00
○ Branco	1003449	161,00

### AINOS CW SENSOR, Quadrado

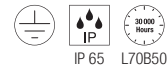
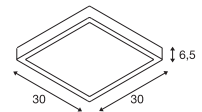

220-240V ~50/60Hz | 500mA  
Potência total: 18W  
Material: alumínio/policarbonato (PC)



Down 1300lm | 3000K | 1300lm | 4000K

Variante	Art. n.º	EUR
● Antracite	1003452	201,00
○ Branco	1003451	201,00

# RUBA CW

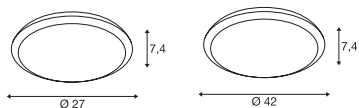

220-240V ~50/60Hz | 600mA  
Potência total: 22W  
Material: policarbonato (PC)



Down	960lm 2000lm	3000K	1100lm 2300lm	4000K
------	-----------------	-------	------------------	-------

Variante	Art. n.º	EUR
○ Branco   Ø: 27cm 960 / 1100lm   12W	<b>1005089</b>	<b>111,00</b>
○ Branco   Ø: 42cm 2000 / 2300lm   22W	<b>1005090</b>	<b>222,00</b>

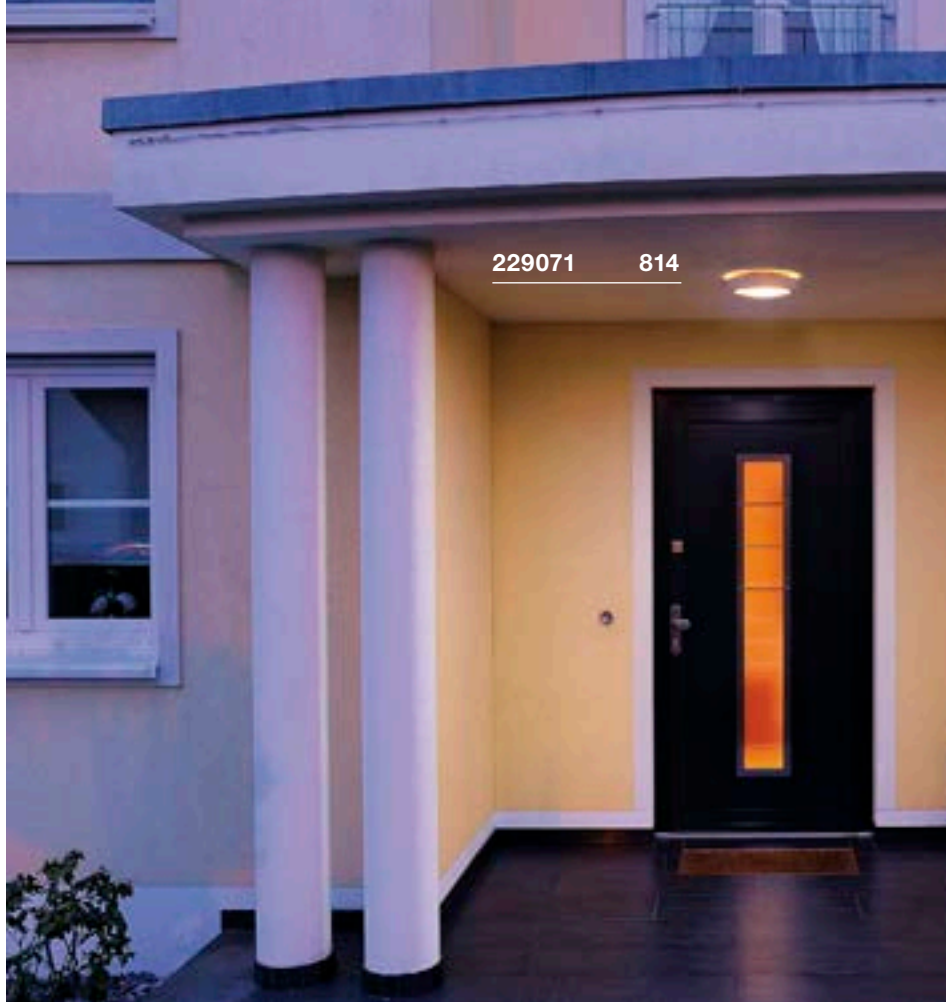

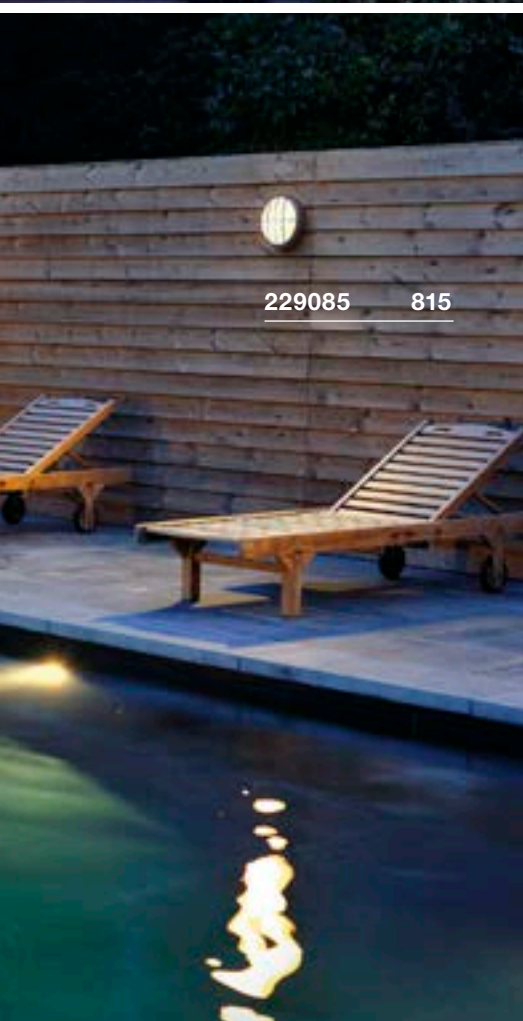

**BULAN**  
CW, E14

**BULAN GRID**  
CW, E27

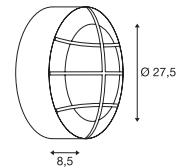
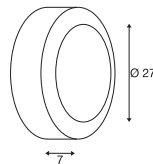

220-240V ~50/60Hz  
Material: alumínio/vidro



220-240V ~50/60Hz  
Material: alumínio/policarbonato (PC)

**229085 815**



Casquilho: 1xE14 Máx. Ø: 4,8 cm | C: 13 cm

Variante	Art. n.º	EUR
● Antracite	229075	66,00
○ Branco	229071	66,00
● Cinzento	229072	66,00



Casquilho: 2xE27 Máx. Ø: 5,2 cm | C: 17,3 cm

Variante	Art. n.º	EUR
● Antracite	229085	70,00
○ Branco	229081	70,00



C35 | 4,2W | 320°  
2700K | 350lm | EE=G  
5kWh/1000h



Art. N.º: 1005285 | 8,50 EUR



| 13,5W | 240°  
4000K | 1600lm | EE=E  
14kWh/1000h



Art. N.º: 1005308 | 12,50 EUR



229935 817





TERANG 200  
CW

IMPERVA 120  
CW

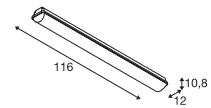
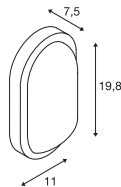

220-240V ~50/60Hz  
Potência total: 11W  
Material: alumínio/policarbonato (PC)

220-240V ~50/60Hz | 700mA  
Potência total: 40W  
Material: policarbonato (PC)



Down 830lm | 3000K

Down 4600lm | 3000K

Variante	Art. n.º	EUR
● Antracite	229935	80,00
○ Branco	229931	80,00

Variante	Art. n.º	EUR
● Cinzento	1001314	110,00



233605 823



**SCKET**

CONCRETO | 821



**LED**

CONCRETO | 821



**LED**

ADI | 822



**LED**

DOWNUNDER  
OUT S | 823



**LED**

DOWNUNDER  
OUT M | 823



**LED**

DOWNUNDER  
OUT L | 823



**LED**

BRICK MESH | 825



**LED**

BRICK | 825



**LED**

BRICK | 825



**SCKET**

BRICK  
DOWNUNDER | 827



**LED**

BRICK  
DOWNUNDER | 827



1006406 821

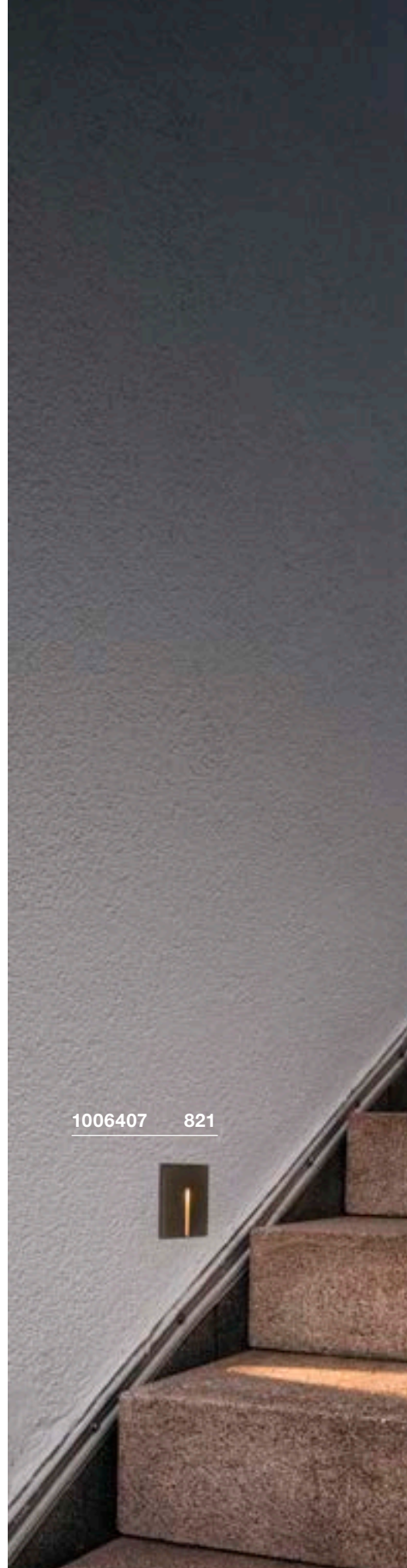

1006407 821



### CONCRETO EL, Wing

### CONCRETO EL, Cut

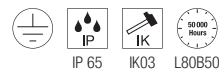
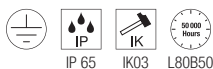
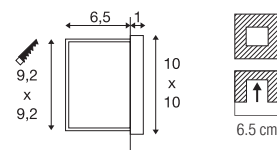
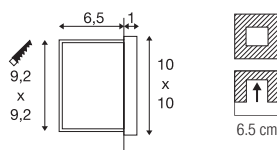

100-240V ~50/60Hz | 700mA  
Potência total: 3,2W  
Material: betão/alumínio

100-240V ~50/60Hz | 700mA  
Potência total: 3,2W  
Material: betão/alumínio

- Montar a luminária com a emissão de luz a apontar apenas para baixo.
- Caixa de instalação incluída.

- Montar a luminária com a emissão de luz a apontar apenas para baixo.
- Caixa de instalação incluída.



Down 45lm | 3000K

Down 15lm | 3000K

Variante	Art. n.º	EUR
● Cinzento	1006406 ●	98,00

Variante	Art. n.º	EUR
● Cinzento	1006407 ●	98,00

ADI  
EL

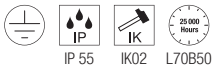
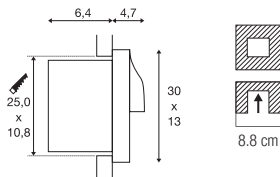

100-277V ~50/60Hz | 500mA  
Potência total: 18W  
Material: alumínio/policarbonato (PC)

- Montar a luminária com a emissão de luz a apontar apenas para baixo.
- A caixa de instalação tem de ser encomendada à parte



Down 940lm | 3000K

Variante	Art. n.º	EUR
● Antracite	233635	262,00



Artigo	Art. n.º	EUR
Caixa de instalação		
● Preto	233639	19,70

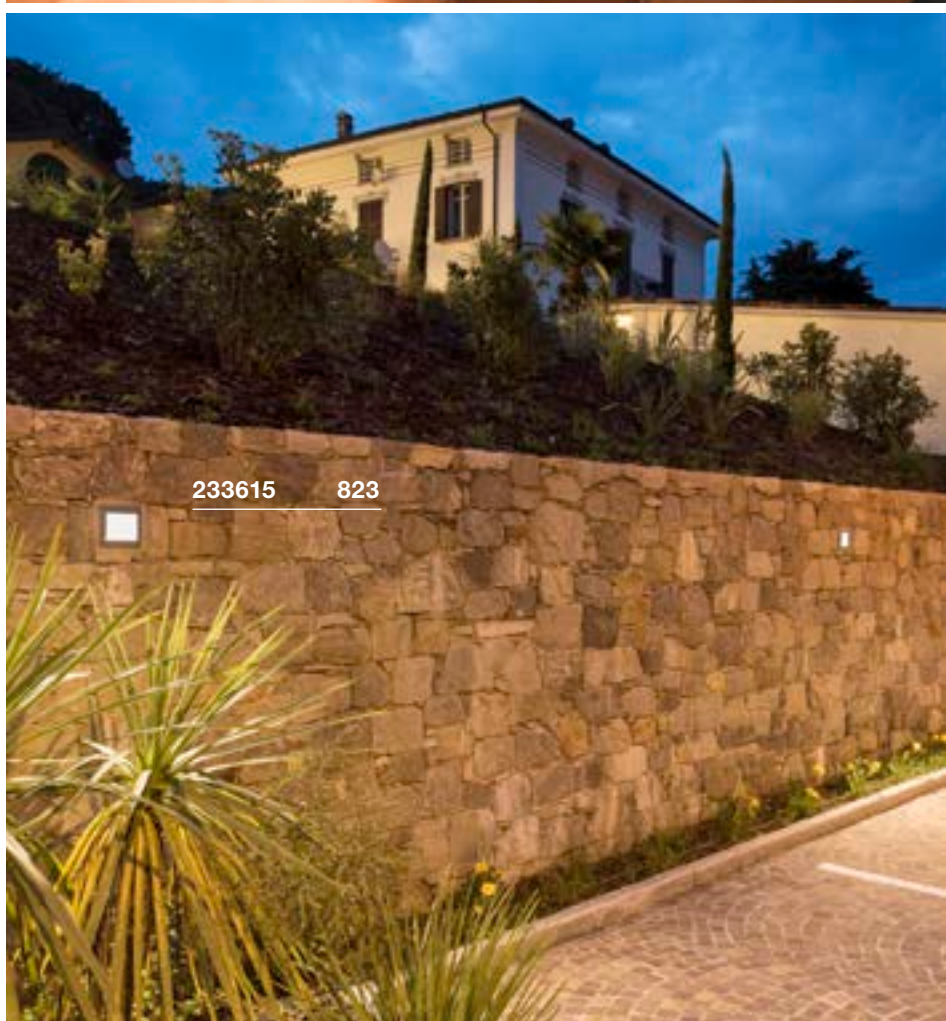



### DOWNUNDER OUT S EL

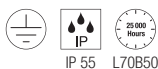
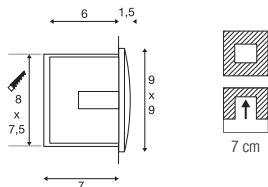

220-240V ~50/60Hz | 300mA  
Potência total: 1,7W  
Material: alumínio/plástico

- Montar a luminária com a emissão de luz a apontar apenas para baixo.
- Caixa de instalação incluída.



Down 25lm | 3000K  
65lm

Variante	Art. n.º	EUR
● Antracite		
25lm	<b>233605</b>	<b>63,00</b>
○ Branco		
65lm	<b>233601</b>	<b>63,00</b>

### DOWNUNDER OUT M EL

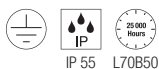
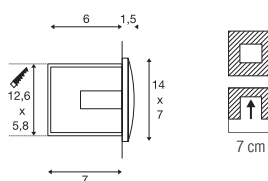

220-240V ~50/60Hz | 300mA  
Potência total: 4W  
Material: alumínio/plástico

- Montar a luminária com a emissão de luz a apontar apenas para baixo.
- Caixa de instalação incluída.



Down 85lm | 3000K  
155lm

Variante	Art. n.º	EUR
● Antracite		
85 lm	<b>233625</b>	<b>75,00</b>
○ Branco		
155lm	<b>233621</b>	<b>75,00</b>

### DOWNUNDER OUT L EL

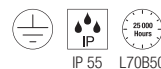
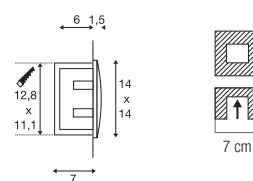

220-240V ~50/60Hz | 300mA  
Potência total: 4W  
Material: alumínio/plástico

- Montar a luminária com a emissão de luz a apontar apenas para baixo.
- Caixa de instalação incluída.



Down 85lm | 3000K

Variante	Art. n.º	EUR
● Antracite	<b>233615</b>	<b>89,00</b>

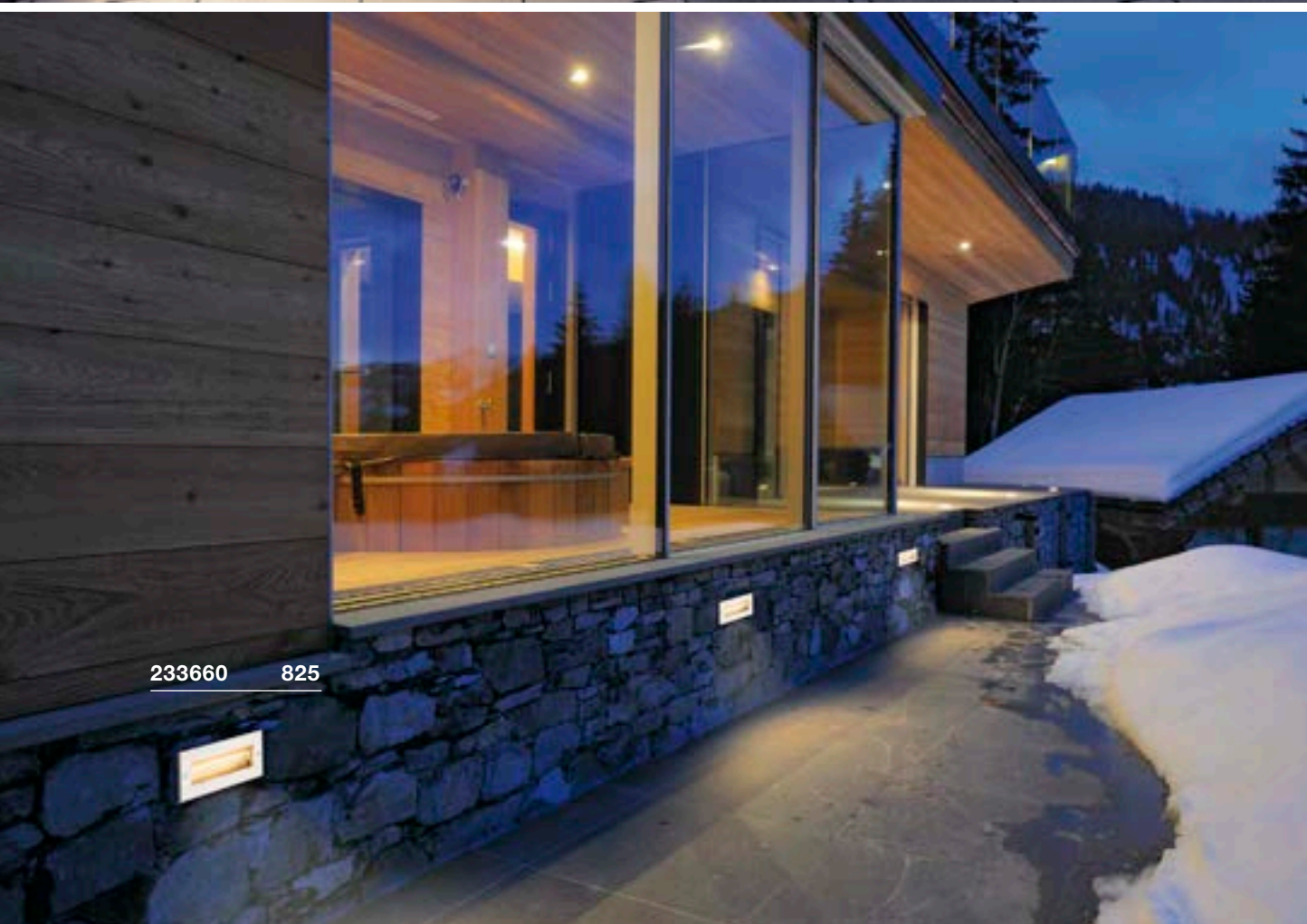





## BRICK MESH EL

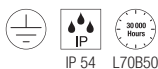
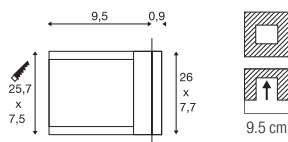
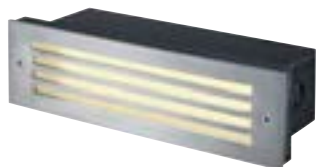

IP 54 L70B50

100-240V ~50/60Hz | 24V  
Potência total: 3,3W  
Material: aço inoxidável 316/vidro

- Caixa de instalação incluída.



Down 52lm | 3000K

Variante	Art. n.º	EUR
● Aço inoxidável	229110	248,00

## BRICK EL, simétrico

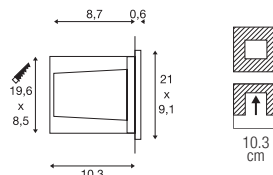

IP 65 IK02 40° L70B50

220-240V ~50/60Hz | 144mA  
Potência total: 9,5W  
Material: alumínio/aço inoxidável 316

- Caixa de instalação incluída.



Down 950lm | 3000K

Variante	Art. n.º	EUR
● Aço inoxidável	233650	303,00

## BRICK EL, assimétrico

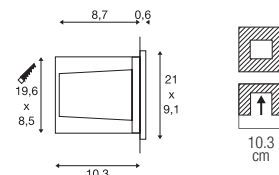

IP 65 IK02 L70B50

220-240V ~50/60Hz | 144mA  
Potência total: 9,5W  
Material: alumínio/aço inoxidável 316

- Caixa de instalação incluída.



Down 850lm | 3000K

Variante	Art. n.º	EUR
● Aço inoxidável	233660	303,00



229062 827



## BRICK DOWNUNDER EL, E14

## BRICK DOWNUNDER EL

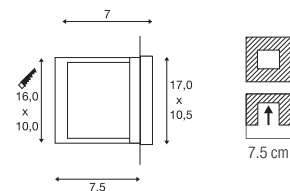
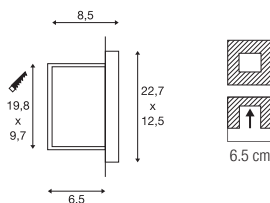

IP 44 IK02 10

220-240V ~50/60Hz  
Material: alumínio/vidro

- Não é necessária caixa de instalação

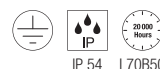

IP 54 L70B50

220-240V ~50/60Hz  
Potência total: 1,4W  
Material: alumínio/vidro

- Caixa de instalação incluída.



Casquilho: 1xE14 Máx. Ø: 4,3 cm | C: 12 cm



Down 30lm | 3000K

Variante	Art. n.º	EUR
● Cinzento	229062	41,50

Variante	Art. n.º	EUR
● Cinzento	229702	67,00



C35 | 4,2W | 320°  
2700K | 350lm | EE=G  
5kWh/1000h



Art. N.º: 1005285 | 8,50 EUR



1006106 839



LED  
DASAR® 600 | 831



LED  
DASAR® 1200 | 831



LED  
DASAR® S | 833



LED  
DASAR® S | 833



LED  
DASAR® L | 835



LED  
DASAR® L | 835



LED  
DASAR® XL | 837



LED  
DASAR® XL | 837



LED  
DASAR®  
FLAT 80 | 839



LED  
DASAR®  
FLAT 120 | 839



LED  
DASAR® 255 | 839



LED  
DASAR® 920 | 840



LED  
DASAR® 920 | 840



LED  
DASAR® 270 | 841



LED  
DASAR® 270 | 841



SCKET  
DASAR® 115 | 843



SCKET  
DASAR® 115 | 843



SCKET  
DASAR® 115 | 843



SCKET  
DASAR®  
EXACT 116 | 845



SCKET  
DASAR®  
EXACT 116 | 845



SCKET  
DASAR® 215 | 846



SCKET  
DASAR® 215 | 846



SCKET  
DASAR® 215 | 847



LED  
DASAR® 215 | 847



LED  
TRAIL-LITE® 60 | 848



LED  
POWER  
TRAIL-LITE® | 849



LED  
POWER  
TRAIL-LITE® | 849



LED  
GIMBLE OUT | 849



LED  
SMALL PLOT | 851



LED  
SMALL PLOT | 851



SMALL PLOT | 851



SMALL PLOT | 851



LED  
BIG PLOT | 853



LED  
BIG PLOT | 853



BIG PLOT | 853



BIG PLOT | 853



LED  
ROCCI | 854



LED  
ROCCI | 854



LED  
ROCCI 200 | 855



LED  
ROCCI 200 | 855



SCKET  
SOLASTO | 857



SCKET  
SOLASTO | 857



1007196 831



### DASAR® 600 EL

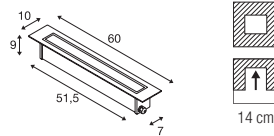

220-240V ~50/60Hz | 550mA  
Potência total: 18W  
Material: aço inoxidável 316

- com conector



Up 2200lm | 3000K

Variante	Art. n.º	EUR
● Aço inoxidável	1007195	● 549,00



Artigo	Art. n.º	EUR
Caixa de instalação		
● Preto	1007198	29,00

### DASAR® 1200 EL

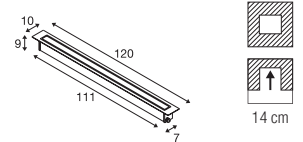

220-240V ~50/60Hz | 900mA  
Potência total: 34W  
Material: aço inoxidável 316

- com conector



Up 4100lm | 3000K

Variante	Art. n.º	EUR
● Aço inoxidável	1007196	● 729,00



Artigo	Art. n.º	EUR
Caixa de instalação		
● Preto	1007197	49,00



1007680 833





### DASAR® S RL, Redondo

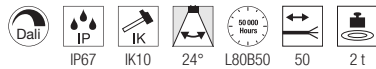
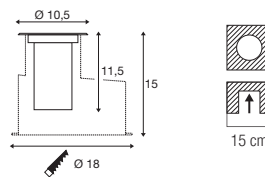

220-240V ~50/60Hz | 200mA  
Potência total: 4W  
Material: alumínio

- Caixa de ligação IP



Up 350lm | 3000K

Variante	Art. n.º	EUR
● Antracite	1007680	● 209,00



Artigo	Art. n.º	EUR
Caixa de instalação no pavimento S		
● Preto	1007682	49,00
Refletor 15°		
○ Prateado	1007683	6,00
Refletor 36°		
○ Prateado	1007684	6,00
Refletor 50°		
○ Prateado	1007685	6,00

### DASAR® S RL, Quadrado

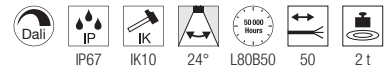
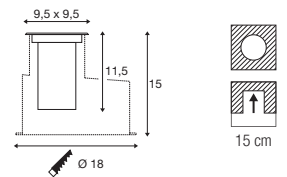

220-240V ~50/60Hz | 200mA  
Potência total: 4W  
Material: alumínio

- Caixa de ligação IP



Up 350lm | 3000K

Variante	Art. n.º	EUR
● Antracite	1007681	● 209,00



Artigo	Art. n.º	EUR
Caixa de instalação no pavimento S		
● Preto	1007682	49,00
Refletor 15°		
○ Prateado	1007683	6,00
Refletor 36°		
○ Prateado	1007684	6,00
Refletor 50°		
○ Prateado	1007685	6,00



1007243 835



### DASAR® L RL, Redondo

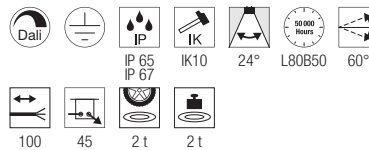
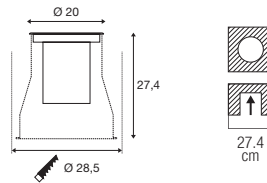

220-240V ~50/60Hz | 500mA  
Potência total: 19W  
Material: alumínio

- com conector em y



Up 1950lm | 3000K

Variante	Art. n.º	EUR
● Aço inoxidável	1007243	● 479,00



Artigo	Art. n.º	EUR
Caixa de instalação para DASAR L		
● Preto	1007245	49,00
Refletor 15° para L/XL		
○ Prateado	1007238	12,00
Refletor 36° para L/XL		
○ Prateado	1007239	12,00
Refletor 60° para L/XL		
○ Prateado	1007240	12,00

### DASAR® L RL, Quadrado

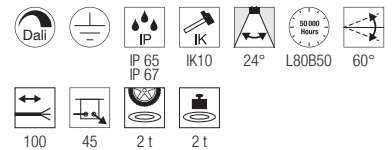
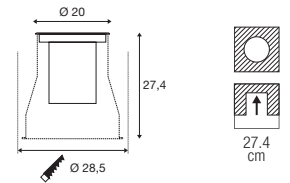

220-240V ~50/60Hz | 500mA  
Potência total: 19W  
Material: alumínio

- com conector em y



Up 1950lm | 3000K

Variante	Art. n.º	EUR
● Preto	1007244	● 479,00



Artigo	Art. n.º	EUR
Caixa de instalação para DASAR L		
● Preto	1007245	49,00
Refletor 15° para L/XL		
○ Prateado	1007238	12,00
Refletor 36° para L/XL		
○ Prateado	1007239	12,00
Refletor 60° para L/XL		
○ Prateado	1007240	12,00



1007242 837



### DASAR® XL RL, Redondo

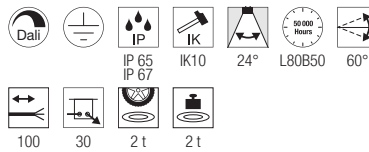
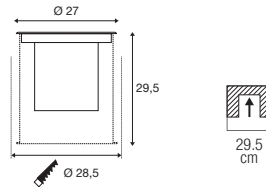

220-240V ~50/60Hz | 700mA  
Potência total: 27W  
Material: alumínio

- com conector em y



Up 2790lm | 3000K

Variante	Art. n.º	EUR
● Aço inoxidável	1007241	● 579,00



Artigo	Art. n.º	EUR
Caixa de instalação para DASAR XL		
● Preto	1007246	59,00
Refletor 15° para L/XL		
○ Prateado	1007238	12,00
Refletor 36° para L/XL		
○ Prateado	1007239	12,00
Refletor 60° para L/XL		
○ Prateado	1007240	12,00

### DASAR® XL RL, Quadrado

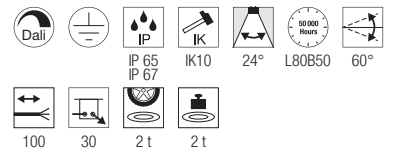
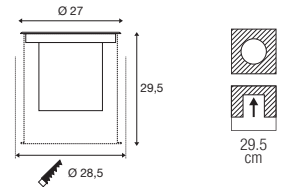

220-240V ~50/60Hz | 700mA  
Potência total: 27W  
Material: alumínio

- com conector em y



Up 2790lm | 3000K

Variante	Art. n.º	EUR
● Aço inoxidável	1007242	● 579,00



Artigo	Art. n.º	EUR
Caixa de instalação para DASAR XL		
● Preto	1007246	59,00
Refletor 15° para L/XL		
○ Prateado	1007238	12,00
Refletor 36° para L/XL		
○ Prateado	1007239	12,00
Refletor 60° para L/XL		
○ Prateado	1007240	12,00



228412 839



229383 839



### DASAR® FLAT 80 EL

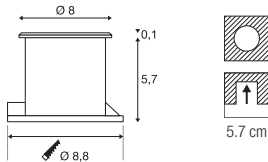

220-240V ~50/60Hz  
Potência total: 3,5W  
Material: aço inoxidável 304/vidro

- Cumpridos os dois tipos de proteção IP.
- A luminária é adequada para instalação em madeira.
- Extremidade do cabo aberta



Up 140lm | 3000K

Variante	Art. n.º	EUR
● Aço inoxidável	<b>228412</b>	<b>109,00</b>



**Artigo** Art. n.º EUR

Caixa de ligação IP68, 3 polos  
● Preto **228730** **23,00**

### DASAR® FLAT 120 EL

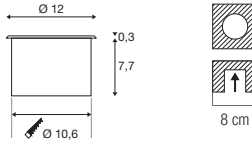

220-240V ~50/60Hz | 350mA  
Potência total: 7W  
Material: aço inoxidável 304/alumínio

- Extremidade do cabo aberta



Up 490lm | 3000K  
540lm | 4000K

Variante	Art. n.º	EUR
● Aço inoxidável 490lm   3000K	<b>1006106</b>	<b>151,00</b>
● Aço inoxidável 540lm   4000K	<b>1006107</b>	<b>151,00</b>

### DASAR® 255 EL

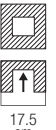
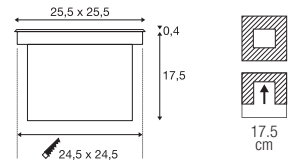

220-240V ~50/60Hz | 750mA  
Potência total: 31W  
Material: aço inoxidável 316/vidro

- Cumpridos os dois tipos de proteção IP.



Up 1660lm | 3000K  
1720lm | 4000K

Variante	Art. n.º	EUR
● Aço inoxidável 1660lm   3000K	<b>229383</b>	<b>403,00</b>
● Aço inoxidável 1720lm   4000K	<b>229381</b>	<b>403,00</b>

DASAR® 920  
EL

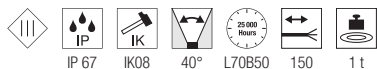
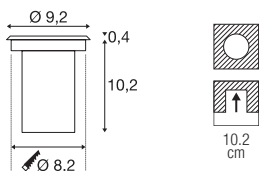

12-24V  
Potência total: 6,5W  
Material: aço inoxidável 316/vidro

- Extremidade do cabo aberta



Up 520lm | 3000K

Variante	Art. n.º	EUR
● Aço inoxidável	233500	151,00



Artigo	Art. n.º	EUR
Fonte de alimentação LED 15W   12V		
○ Branco	1005444	29,50
Fonte de alimentação LED 15W   24V		
○ Branco	1005445	29,50

DASAR® 920  
EL

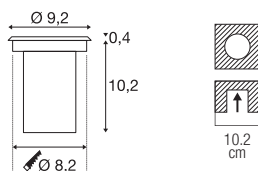

220-240V ~50/60Hz | 400mA  
Potência total: 5,5W  
Material: aço inoxidável 316/vidro

- Extremidade do cabo aberta



Up 300lm | 3000K

Variante	Art. n.º	EUR
● Aço inoxidável	233520	197,00



233500 840







**DASAR® 270**  
EL, assimétrico

**DASAR® 270**  
EL, simétrico

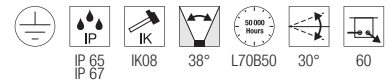
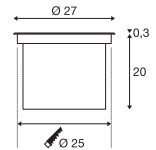
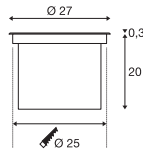

220-240V ~50/60Hz | 700mA  
Potência total: 30W  
Material: aço inoxidável 316/vidro

220-240V ~50/60Hz | 700mA  
Potência total: 30W  
Material: aço inoxidável 316/vidro



Up 2000lm | 3000K  
2100lm | 4000K

Up 2500lm | 3000K  
2600lm | 4000K

Variante	Art. n.º	EUR
● Aço inoxidável 2000lm   3000K	<b>1002893</b>	<b>454,00</b>
● Aço inoxidável 2100lm   4000K	<b>1002895</b>	<b>454,00</b>

Variante	Art. n.º	EUR
● Aço inoxidável 2500lm   3000K	<b>1002897</b>	<b>454,00</b>
● Aço inoxidável 2600lm   4000K	<b>1002898</b>	<b>454,00</b>



Artigo	Art. n.º	EUR
DASAR® 270   Cobertura de favo de mel		
● Preto	<b>1002899</b>	<b>12,90</b>



229320 843



**DASAR® 115**  
RL, Quadrado, QPAR51

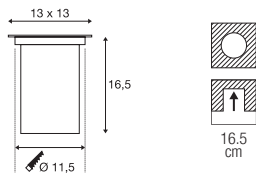

220-240V ~50/60Hz  
Material: aço inoxidável 316/vidro



Casquilho: 1xGU10 Máx. Ø: 5,1 cm C: 6 cm

Variante	Art. n.º	EUR
● Aço inoxidável	229324	114,00

LED GU10 51 mm | 6W | 38°  
 2700K | 450lm | EE=F  
 6kWh/1000h

Art. N.º: 1005075 | 7,50 EUR

**DASAR® 115**  
RL, Redondo, QPAR51

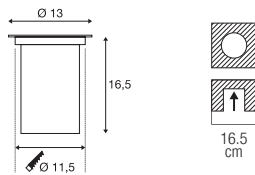

220-240V ~50/60Hz  
Material: aço inoxidável 316/vidro



Casquilho: 1xGU10 Máx. Ø: 5,1 cm C: 6 cm

Variante	Art. n.º	EUR
● Aço inoxidável	229320	114,00

LED GU10 51 mm | 6W | 38°  
 2700K | 450lm | EE=F  
 6kWh/1000h

Art. N.º: 1005075 | 7,50 EUR

**DASAR® 115**  
RL, Quadrado, QPAR51

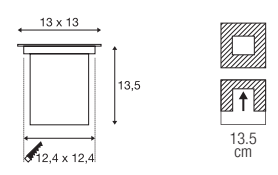

220-240V ~50/60Hz  
Material: aço inoxidável 316/vidro



Casquilho: 1xGU10 Máx. Ø: 5,1 cm C: 6 cm

Variante	Art. n.º	EUR
● Aço inoxidável	229374	114,00

LED GU10 51 mm | 6W | 38°  
 2700K | 450lm | EE=F  
 6kWh/1000h

Art. N.º: 1005075 | 7,50 EUR



228430 845



DASAR® EXACT 116  
EL, Quadrado, QPAR51

DASAR® EXACT 116  
EL, Redondo, QPAR51

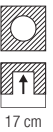
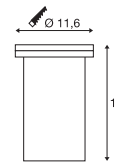
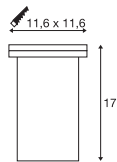

220-240V ~50/60Hz  
Material: aço inoxidável 316/vidro

220-240V ~50/60Hz  
Material: aço inoxidável 316/vidro



Casquilho: 1xGU10 Máx. Ø: 5,1 cm C: 6 cm

Casquilho: 1xGU10 Máx. Ø: 5,1 cm C: 6 cm

Variante	Art. n.º	EUR
● Aço inoxidável	228434	124,00

Variante	Art. n.º	EUR
● Aço inoxidável	228430	124,00



LED GU10 51 mm | 6W | 38°  
2700K | 450lm | EE=F  
6kWh/1000h



Art. N.º: 1005077 | 7,50 EUR



LED GU10 51 mm | 6W | 38°  
2700K | 450lm | EE=F  
6kWh/1000h



Art. N.º: 1005077 | 7,50 EUR

DASAR® 215  
RL, Redondo, QPAR111

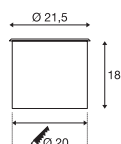

220-240V ~50/60Hz  
Material: aço inoxidável 316/vidro

**SOCKET**  
**INSIDE** <75  
W

Casquilho: 1xGU10

Variante	Art. n.º	EUR
● Aço inoxidável	229230	268,00



QPAR111 | 12,5W | 10°  
3000K | 950lm | EE=F  
13kWh/1000h



Art. N.º: 1005278 | 55,00 EUR

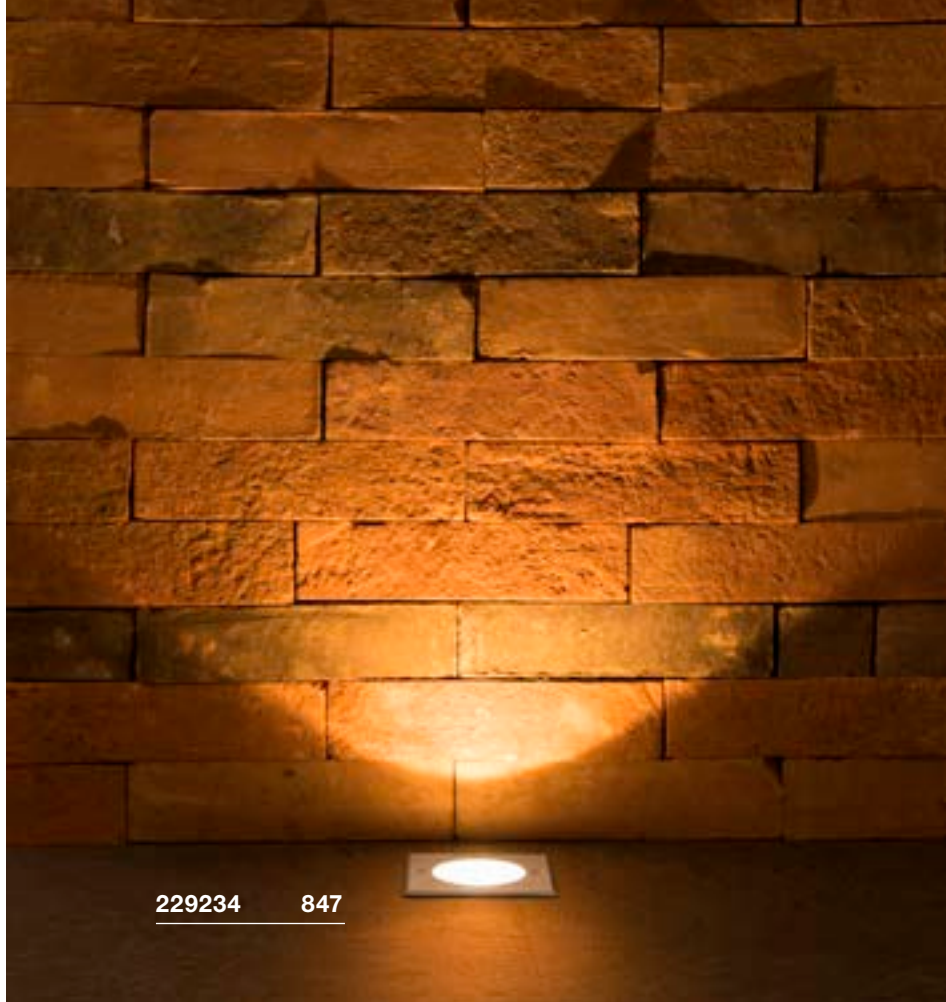



**DASAR® 215**  
RL, Quadrado, QPAR111

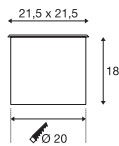

220-240V ~50/60Hz  
Material: aço inoxidável 316/vidro



Casquilho: 1xGU10

Variante	Art. n.º	EUR
● Aço inoxidável	229234	268,00



QPAR111 | 12,5W | 10°  
3000K | 950lm | EE=F  
13kWh/1000h



Art. N.º: 1005278 | 55,00 EUR

**DASAR® 215**  
RL, Redondo, E27

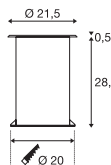

220-240V ~50/60Hz  
Material: aço inoxidável 316/vidro



Casquilho: 1xE27 Máx. Ø: 4,5 cm | C: 13,4 cm

Variante	Art. n.º	EUR
● Aço inoxidável	229200	256,00



LED E27 | 8W | 240°  
3000K | 880lm | EE=E  
8kWh/1000h



Art. N.º: 1005289 | 10,25 EUR

**DASAR® 370**  
EL, Redondo

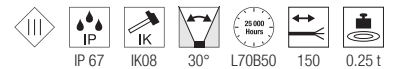
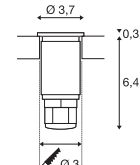

12-24V  
Consumo de energia: 2W  
Material: aço inoxidável 316/vidro

- A luminária é adequada para instalação em madeira
- Extremidade do cabo aberta



Up 120lm | 3000K

Variante	Art. n.º	EUR
● Aço inoxidável	233540	171,00



Artigo	Art. n.º	EUR
Fonte de alimentação LED 15W   12V		
○ Branco	1005444	29,50
Fonte de alimentação LED 15W   24V		
○ Branco	1005445	29,50

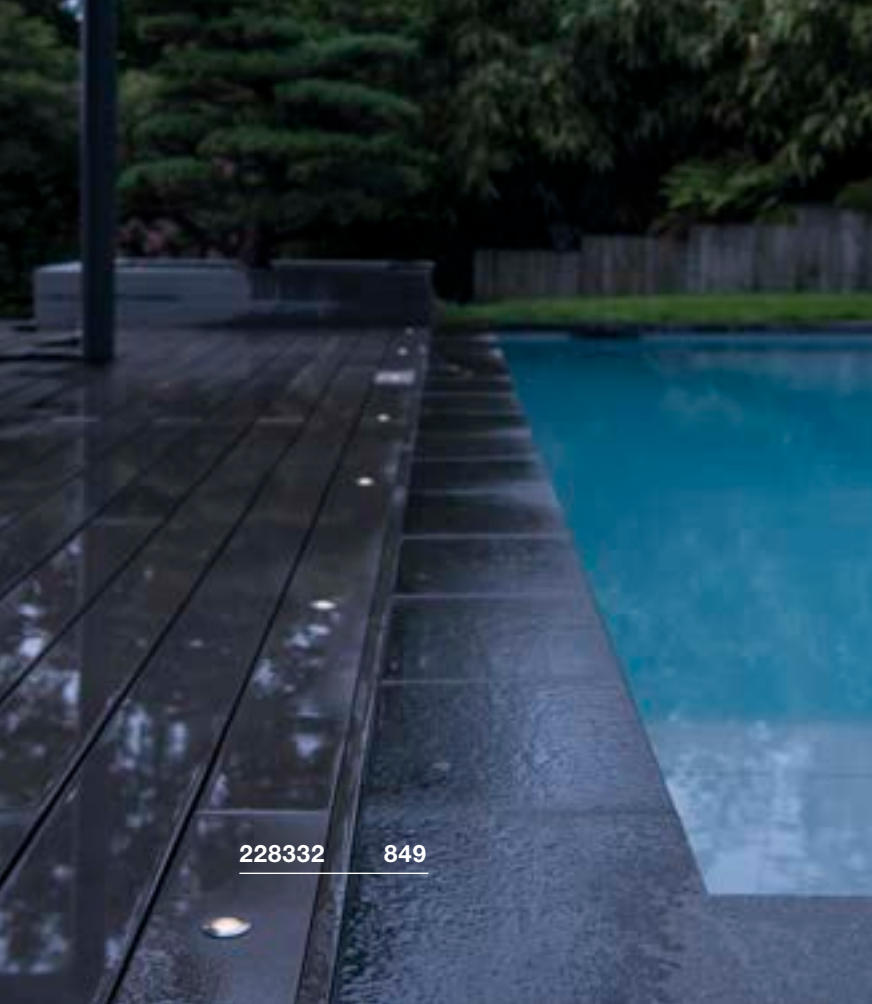

228332 849

## TRAIL-LITE® 60 EL

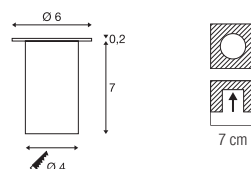

1000384 849



12V ~50/60Hz  
Consumo de energia: 0,3W  
Material: aço inoxidável 316/vidro

- Funcionamento apenas com transformador convencional.
- Caixa de instalação incluída.
- A luminária é adequada para instalação em madeira



Up

10lm | 3000K

Variante	Art. n.º	EUR
● Aço inoxidável	227462	70,00





### POWER TRAIL-LITE® EL, Quadrado

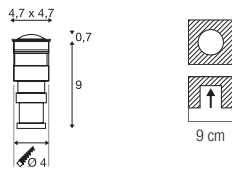

350mA  
Potência total: 1W  
Material: aço inoxidável 316/vidro

- Funcionamento apenas com controlador de 350 mA. A ligação de vários LED de potência apenas deve ser feita com ligação em série! Com caixa de instalação tubular. A luminária é adequada para instalação em madeira
- Extremidade do cabo aberta



Up 45lm | 3000K

Variante	Art. n.º	EUR
● Aço inoxidável	228342	80,00



Artigo	Art. n.º	EUR
Controlador LED 3W   350 mA		
○ Branco	1005248	15,00

### POWER TRAIL-LITE® EL, Redondo

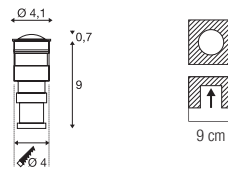

350mA  
Potência total: 1W  
Material: aço inoxidável 316/vidro

- Funcionamento apenas com controlador 350 mA. A ligação de vários LED de potência apenas deve ser feita com ligação em série!
- A luminária é adequada para instalação em madeira.
- Extremidade do cabo aberta



Up 45lm | 3000K

Variante	Art. n.º	EUR
● Aço inoxidável	228332	80,00

### GIMBLE OUT EL

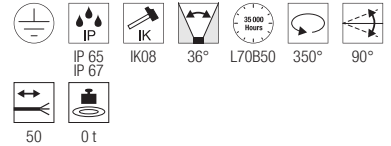
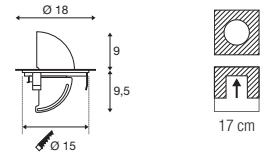

220-240V ~50/60Hz | 600mA  
Potência total: 13W  
Material: aço inoxidável 316

- Extremidade do cabo aberta



Up 1100lm | 3000K

Variante	Art. n.º	EUR
● Aço inoxidável	1000384	384,00



Artigo	Art. n.º	EUR
Caixa de instalação no pavimento		
● Preto	1000655	72,00
○ Cinzento	233792	54,00
Caixa de ligação IP68, 3 polos		
● Preto	228730	23,00



1006171 + 1006173 851



### SMALL PLOT Módulos



### SMALL PLOT Módulos



### SMALL PLOT Cobertura, 2.<sup>a</sup>



A: 1,7 cm  
 Ø: 10,3 cm  
 Material 1006173: aço inoxidável  
 Material 1006174: alumínio

- 500 kg de carga para 1006174
- 800 kg de carga para 1006173

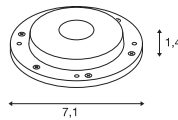
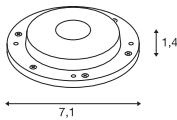

Variante	Art. n.º	EUR
● Antracite	<b>1006174</b>	<b>42,25</b>
● Aço inoxidável	<b>1006173</b>	<b>141,00</b>



24V DC  
 Consumo de energia: 2,6W  
 Material: alumínio/polimetilacrilato (PMMA)

- O produto é entregue sem tampa.
- Extremidade do cabo aberta



Up 240lm | 3000K

Variante	Art. n.º	EUR
● Alumínio	<b>1006172</b>	<b>82,00</b>



24V DC  
 Consumo de energia: 2,6W  
 Material: aço inoxidável/polimetilacrilato (PMMA)

- O produto é entregue sem tampa.
- Extremidade do cabo aberta



Up 240lm | 3000K

Variante	Art. n.º	EUR
● Aço inoxidável	<b>1006171</b>	<b>97,00</b>

### SMALL PLOT Cobertura, 4.<sup>a</sup>



800 kg

A: 1,7 cm  
 Ø: 10,3 cm  
 Material 1006175: aço inoxidável  
 Material 1006176: alumínio



Artigo	Art. n.º	EUR
○ Branco	<b>1005381</b>	<b>39,50</b>
Fonte de alimentação LED 15W   24V		
○ Branco	<b>1005445</b>	<b>29,50</b>



Artigo	Art. n.º	EUR
○ Branco	<b>1005381</b>	<b>39,50</b>
Fonte de alimentação LED 15W   24V		
○ Branco	<b>1005445</b>	<b>29,50</b>

Variante	Art. n.º	EUR
● Antracite	<b>1006176</b>	<b>42,25</b>
● Aço inoxidável	<b>1006175</b>	<b>141,00</b>



1001359 + 1001255 853



### BIG PLOT Módulos

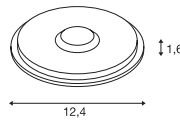
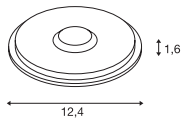

220-240V ~50/60Hz  
Potência total: 5,5W  
Material: alumínio/polimetilacrilato (PMMA)

- O produto é entregue sem tampa
- Extremidade do cabo aberta



Up 500lm | 3000K

Variante	Art. n.º	EUR
● Alumínio	1001256	92,00



Artigo	Art. n.º	EUR
Caixa de conector em T		
● Preto	228726	36,00
Caixa de ligação IP68, 3 polos		
● Preto	228730	23,00

### BIG PLOT Módulos

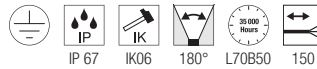

220-240V ~50/60Hz  
Potência total: 5,5W  
Material: aço inoxidável/  
polimetilacrilato (PMMA)

- O produto é entregue sem tampa
- Extremidade do cabo aberta



Up 500lm | 3000K

Variante	Art. n.º	EUR
● Aço inoxidável	1001359	133,00



Artigo	Art. n.º	EUR
Caixa de conector em T		
● Preto	228726	36,00
Caixa de ligação IP68, 3 polos		
● Preto	228730	23,00

### BIG PLOT Cobertura, 2.<sup>a</sup>



A: 2 cm  
Ø: 17 cm  
Material: alumínio

- 500 kg de carga para 1001262
- 800 kg de carga para 1001254

Variante	Art. n.º	EUR
● Antracite	1001262	56,00
● Aço inoxidável	1001254	198,00

### BIG PLOT Cobertura, 4.<sup>a</sup>



800 kg

A: 2 cm  
Ø: 17 cm  
Material: aço inoxidável 316

Variante	Art. n.º	EUR
● Antracite	1001263	56,00
● Aço inoxidável	1001255	198,00

ROCCI  
EL, Quadrado

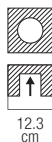
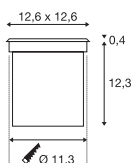

100-277V ~50/60Hz | 700mA  
Potência total: 8,6W  
Material: aço inoxidável 316/vidro



Up 580lm | 3000K

Variante	Art. n.º	EUR
● Aço inoxidável	227604	167,00

ROCCI  
EL, Redondo

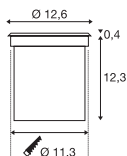

100-277V ~50/60Hz | 700mA  
Potência total: 8,6W  
Material: aço inoxidável 316/vidro



Up 580lm | 3000K

Variante	Art. n.º	EUR
● Aço inoxidável	227600	167,00

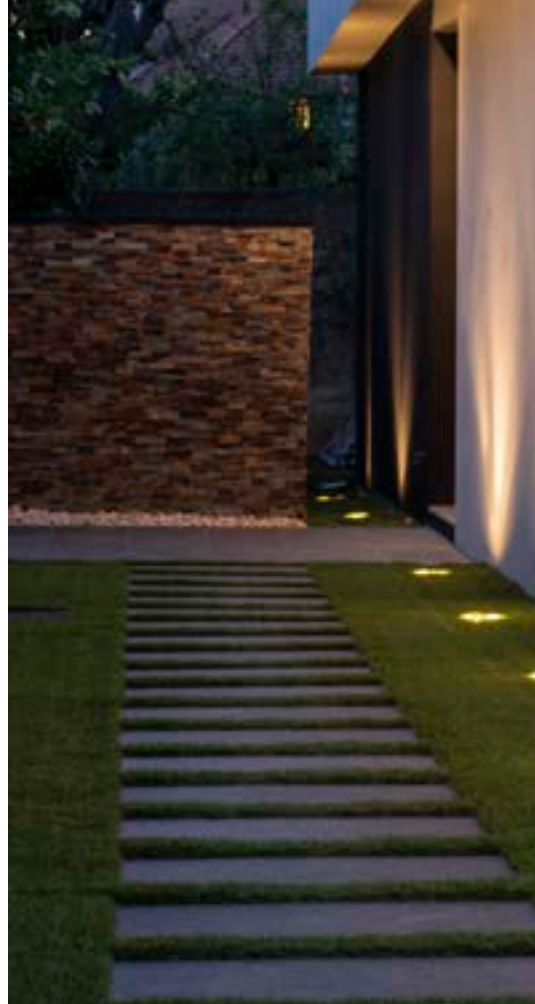



227604 854



1006105 855

ROCCI 200  
EL, Quadrado

ROCCI 200  
EL, Redondo

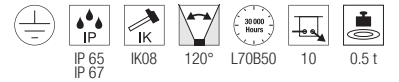
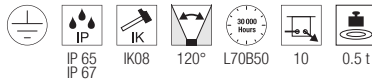
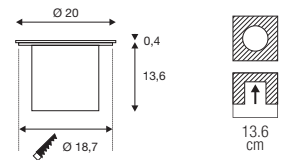
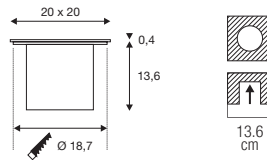

100-277V ~50/60Hz | 350mA  
Potência total: 16W  
Material: aço inoxidável 316/vidro

100-277V ~50/60Hz | 350mA  
Potência total: 16W  
Material: aço inoxidável 316/vidro



Up 1530lm | 3000K



Up 1530lm | 3000K

Variante	Art. n.º	EUR
● Aço inoxidável	1006105	187,00

Variante	Art. n.º	EUR
● Aço inoxidável	1006104	187,00



227680

857





### SOLASTO EL, Quadrado

### SOLASTO EL, Redondo

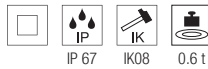
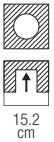
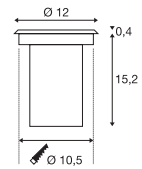
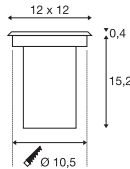

220-240V ~50/60Hz  
Material: aço inoxidável 304/vidro



Casquilho: 1xGU10

Variante	Art. n.º	EUR
● Aço inoxidável	227684	70,00



LED GU10 51 mm | 6W | 38°  
2700K | 450lm | EE=F  
6kWh/1000h



Art. N.º: 1005075 | 7,50 EUR

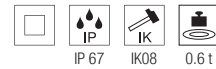

220-240V ~50/60Hz  
Material: aço inoxidável 304/vidro



Casquilho: 1xGU10

Variante	Art. n.º	EUR
● Aço inoxidável	227680	70,00



LED GU10 51 mm | 6W | 38°  
2700K | 450lm | EE=F  
6kWh/1000h



Art. N.º: 1005075 | 7,50 EUR

1006400 281





LED QT | 860



LED C35 | 860



LED TCR-TSE | 860



LED QR51 | 861



LED QPAR51 | 861



LED | 862

LED QPAR111 |  
862, 863, 864

QPAR111 | 862, 863



LED A60 | 864, 865



LED T32 | 861



LED T38 | 865



LED T45 | 865



LED ST64 | 865



LED ST58 | 865



LED G125 | 865

### LED QT14 G9

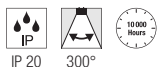

220-240V ~50/60Hz  
Potência: 3,6W  
Material: cerâmica  
Ø: 1,8 cm C: 5,4 cm

Fluxo luminoso	400lm
Corrente da Lâmpada	0,03A
Índice de reprodução cromática	93
Potência	3,6W
Consumo de energia/1000 h	4kWh

Variante	Art. n.º	EUR
<input type="radio"/> Branco 3000K	<b>1005286</b>	<b>9,99</b>

### LED QT-DE12 R7S, 78 mm

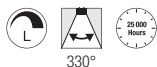

220-240V ~50/60Hz  
Potência: 9W  
Material: policarbonato (PC)  
Ø: 2,9 cm C: 2,9 cm

Fluxo luminoso	1050lm
Corrente da Lâmpada	0,043A
Índice de reprodução cromática	95
Potência	9W
Consumo de energia/1000 h	9kWh

Variante	Art. n.º	EUR
<input checked="" type="radio"/> Cinzento 3000K	<b>1005287</b>	<b>24,00</b>

### LED QT-DE12 R7S, 118 mm



220-240V ~50/60Hz  
Potência: 15W  
Material: policarbonato (PC)  
Ø: 2,9 cm C: 2,9 cm

Fluxo luminoso	2000lm
Corrente da Lâmpada	0,068A
Índice de reprodução cromática	92
Potência	15W
Consumo de energia/1000 h	15kWh

Variante	Art. n.º	EUR
<input checked="" type="radio"/> Cinzento 3000K	<b>1005288</b>	<b>28,50</b>

### LED C35 E14

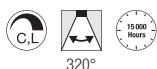

220-240V ~50/60Hz  
Potência: 4,2W  
Material: vidro  
Ø: 3,5 cm C: 9,8 cm

Fluxo luminoso	380lm
Corrente da Lâmpada	0,025A
Índice de reprodução cromática	90
Potência	4,2W
Consumo de energia/1000 h	5kWh

Variante	Art. n.º	EUR
<input type="radio"/> Transparente 2700K	<b>1005284</b>	<b>6,50</b>

### LED C35 E14



220-240V ~50/60Hz  
Potência: 4,2W  
Material: vidro  
Ø: 3,5 cm C: 9,8 cm

Fluxo luminoso	350lm
Corrente da Lâmpada	0,025A
Índice de reprodução cromática	90
Potência	4,2W
Consumo de energia/1000 h	5kWh

Variante	Art. n.º	EUR
<input type="radio"/> Branco 2700K	<b>1005285</b>	<b>8,50</b>

### LED TCR-TSE GX53



220-240V ~50/60Hz  
Potência: 6,1W  
Material: policarbonato (PC)/  
policarbonato (PC)  
Ø: 7,5 cm C: 2,4 cm

Fluxo luminoso	490lm
Corrente da Lâmpada	0,034A
Índice de reprodução cromática	93
Potência	6,1W
Consumo de energia/1000 h	6kWh

Variante	Art. n.º	EUR
<input type="radio"/> Branco 2700K	<b>1005272</b>	<b>11,50</b>
<input type="radio"/> Branco 3000K	<b>1005271</b>	<b>11,50</b>
<input type="radio"/> Branco 4000K	<b>1005269</b>	<b>11,50</b>

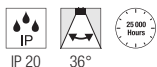
LED QR51  
GU5.3

12V AC  
Potência: 5,8W  
Material: vidro  
Ø: 5 cm C: 4,5 cm

Fluxo luminoso	450lm
Corrente da Lâmpada	0,63A
Intensidade máx. da luz	1300cd
Índice de reprodução cromática	90
Potência	5,8W
Consumo de energia/1000 h	6kWh

Variante	Art. n.º	EUR
<input type="radio"/> Transparente 2700K	1001574	35,00
<input type="radio"/> Transparente 3000K	1001575	35,00

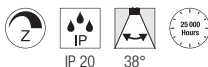
LED QPAR51  
GU10, tunable 2700-6500K, smart

220-240V ~50/60Hz  
Potência: 5W  
Material: poliamida 66 (PA 66)/  
policarbonato (PC)  
Ø: 5 cm C: 5,4 cm

Fluxo luminoso	350lm
Corrente da Lâmpada	0,04A
Intensidade máx. da luz	530cd
Índice de reprodução cromática	92
Potência	5W
Consumo de energia/1000 h	5kWh

Variante	Art. n.º	EUR
<input type="radio"/> Branco 2700-6500K	1005311	37,75

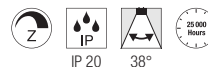
LED QPAR51  
GU10, RGBW, smart

220-240V ~50/60Hz  
Potência: 5,2W  
Material: poliamida 66 (PA 66)/  
policarbonato (PC)  
Ø: 5 cm C: 6,1 cm

Fluxo luminoso	350lm
Corrente da Lâmpada	0,042A
Intensidade máx. da luz	680cd
Índice de reprodução cromática	92
Potência	5,2W
Consumo de energia/1000 h	5kWh

Variante	Art. n.º	EUR
<input type="radio"/> Branco	1005312	54,00

LED QPAR51  
GU10

220-240V ~50/60Hz  
Potência: 2,4W  
Material: vidro  
Ø: 5 cm C: 5,4 cm

Fluxo luminoso	230lm
Corrente da Lâmpada	0,025A
Intensidade máx. da luz	450cd
Índice de reprodução cromática	80
Potência	2,4W
Consumo de energia/1000 h	3kWh

Variante	Art. n.º	EUR
<input type="radio"/> Transparente 2700K	1007230	6,50
<input type="radio"/> Transparente 3000K	1007231	6,50

LED T32  
GU10

220-240V ~50/60Hz  
Potência: 3,2W  
Material: vidro  
Ø: 3,2 cm C: 10 cm

Fluxo luminoso	270lm
Corrente da Lâmpada	0,0175A
Índice de reprodução cromática	90
Potência	3,2W

Variante	Art. n.º	EUR
<input type="radio"/> Transparente 2700K	1006321	48,00

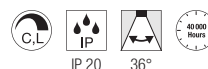
LED QPAR51  
GU10

220-240V ~50/60Hz  
Potência: 6W  
Material: vidro  
Ø: 5 cm C: 5 cm

Fluxo luminoso	360lm
Corrente da Lâmpada	0,033A
Intensidade máx. da luz	680cd
Índice de reprodução cromática	93
Potência	6W
Consumo de energia/1000 h	6kWh

Variante	Art. n.º	EUR
<input type="radio"/> Prateado 2200-2700K	1005273	9,99

LED QPAR51  
GU10

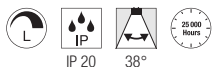

220-240V ~50/60Hz  
Potência: 6W  
Material: policarbonato (PC)  
Ø: 5 cm C: 5 cm

Fluxo luminoso	450lm
Corrente da Lâmpada	0.037A
Intensidade máx. da luz	880cd
Índice de reprodução cromática	92
Potência	6W
Consumo de energia/1000 h	6kWh

Variante	Art. n.º	EUR
● Preto		
2700K	1005077	7,50
● Preto		
3000K	1005080	7,50
● Preto		
4000K	1005083	7,50

LED QPAR51  
GU10

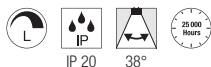

220-240V ~50/60Hz  
Potência: 6W  
Material: policarbonato (PC)  
Ø: 5 cm C: 5 cm

Fluxo luminoso	450lm
Corrente da Lâmpada	0.037A
Intensidade máx. da luz	880cd
Índice de reprodução cromática	92
Potência	6W
Consumo de energia/1000 h	6kWh

Variante	Art. n.º	EUR
○ Branco		
2700K	1005076	7,50
○ Branco		
3000K	1005079	7,50
○ Branco		
4000K	1005082	7,50

LED QPAR51  
GU10

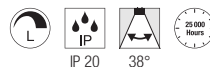

220-240V ~50/60Hz  
Potência: 6W  
Material: policarbonato (PC)  
Ø: 5 cm C: 5,4 cm

Fluxo luminoso	450lm
Corrente da Lâmpada	0.037A
Intensidade máx. da luz	880cd
Índice de reprodução cromática	92
Potência	6W
Consumo de energia/1000 h	6kWh

Variante	Art. n.º	EUR
● Cinzento		
2700K	1005075	7,50
● Cinzento		
3000K	1005078	7,50
● Cinzento		
4000K	1005081	7,50

LED QPAR111  
GU10

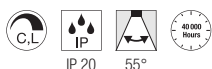

220-240V ~50/60Hz  
Potência: 12W  
Material: alumínio  
Ø: 11 cm C: 7 cm

Fluxo luminoso	680lm
Corrente da Lâmpada	0.05A
Intensidade máx. da luz	930cd
Índice de reprodução cromática	90
Potência	12W
Consumo de energia/1000 h	12kWh

Variante	Art. n.º	EUR
● Alumínio		
2700K	1005297	85,00
● Alumínio		
3000K	1005298	85,00
● Alumínio		
4000K	1005299	85,00

QPAR111  
GU10, RGBW, smart

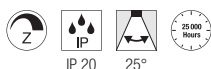

220-240V ~50/60Hz  
Potência: 10W  
Material: alumínio  
Ø: 11,1 cm C: 7 cm

Fluxo luminoso	750lm
Corrente da Lâmpada	0.059A
Intensidade máx. da luz	3500cd
Índice de reprodução cromática	94
Potência	10W
Consumo de energia/1000 h	10kWh

Variante	Art. n.º	EUR
○ Branco	1005315	68,00

QPAR111  
GU10, RGBW, smart

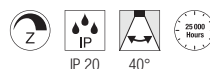

220-240V ~50/60Hz  
Potência: 10W  
Material: alumínio/policarbonato (PC)  
Ø: 11,1 cm C: 7 cm

Fluxo luminoso	780lm
Corrente da Lâmpada	0.059A
Intensidade máx. da luz	2000cd
Índice de reprodução cromática	94
Potência	10W
Consumo de energia/1000 h	10kWh

Variante	Art. n.º	EUR
○ Branco	1005316	68,00



### QPAR111 GU10, tunable 2700-6500K, smart



220-240V ~50/60Hz  
Potência: 10W  
Material: alumínio/policarbonato (PC)  
Ø: 11,1 cm C: 7 cm

Fluxo luminoso	760lm
Corrente da Lâmpada	0,053A
Intensidade máx. da luz	4000cd
Índice de reprodução cromática	93
Potência	10W
Consumo de energia/1000 h	10kWh

Variante	Art. n.º	EUR
○ Branco		
2700-6500K   25°	<b>1005313</b>	<b>52,00</b>
○ Branco		
2700-6500K   40°	<b>1005314</b>	<b>52,00</b>

### LED QPAR111 GU10



220-240V ~50/60Hz  
Potência: 12,5W  
Material: alumínio  
Ø: 11,1 cm C: 7 cm

Fluxo luminoso	900lm
Corrente da Lâmpada	0,058A
Intensidade máx. da luz	11000cd
Índice de reprodução cromática	90
Potência	12,5W
Consumo de energia/1000 h	13kWh

Variante	Art. n.º	EUR
○ Prateado		
2700K	<b>1005275</b>	<b>55,00</b>
○ Prateado		
3000K	<b>1005278</b>	<b>55,00</b>
○ Prateado		
4000K	<b>1005281</b>	<b>55,00</b>

### LED QPAR111 GU10

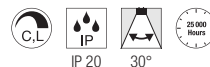

220-240V ~50/60Hz  
Potência: 12,5W  
Material: alumínio  
Ø: 11,1 cm C: 7 cm

Fluxo luminoso	950lm
Corrente da Lâmpada	0,058A
Intensidade máx. da luz	3000cd
Índice de reprodução cromática	93
Potência	12,5W
Consumo de energia/1000 h	13kWh

Variante	Art. n.º	EUR
○ Prateado		
2700K	<b>1005276</b>	<b>49,50</b>
○ Prateado		
3000K	<b>1005279</b>	<b>49,50</b>
○ Prateado		
4000K	<b>1005282</b>	<b>49,50</b>

### LED QPAR111 GU10

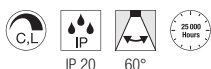

220-240V ~50/60Hz  
Potência: 12,5W  
Material: alumínio  
Ø: 11,1 cm C: 7 cm

Fluxo luminoso	1000lm
Corrente da Lâmpada	0,058A
Intensidade máx. da luz	1000cd
Índice de reprodução cromática	93
Potência	12,5W
Consumo de energia/1000 h	13kWh

Variante	Art. n.º	EUR
○ Prateado		
2700K	<b>1005277</b>	<b>49,50</b>
○ Prateado		
3000K	<b>1005280</b>	<b>49,50</b>
○ Prateado		
4000K	<b>1005283</b>	<b>49,50</b>

### LED QPAR111 GU10



220-240V ~50/60Hz  
Potência: 8W  
Material: vidro  
Ø: 11,1 cm C: 6,1 cm

Fluxo luminoso	680lm
Corrente da Lâmpada	0,046A
Intensidade máx. da luz	1300cd
Índice de reprodução cromática	93
Potência	8W
Consumo de energia/1000 h	8kWh

Variante	Art. n.º	EUR
○ Transparente		
2700K	<b>1005274</b>	<b>30,75</b>

### LED QPAR111 GU10

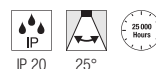

220-240V ~50/60Hz  
Potência: 7,3W  
Material: plástico/alumínio  
Ø: 11,1 cm C: 7,1 cm

Fluxo luminoso	530lm
Corrente da Lâmpada	0,051A
Intensidade máx. da luz	1400cd
Índice de reprodução cromática	93
Potência	7,3W
Consumo de energia/1000 h	8kWh

Variante	Art. n.º	EUR
○ Prateado		
2700K	<b>1005291</b>	<b>24,50</b>
○ Prateado		
3000K	<b>1005292</b>	<b>24,50</b>

### LED QPAR111 GU10



220-240V ~50/60Hz  
Potência: 7,3W  
Material: plástico/alumínio  
Ø: 11,1 cm C: 7,1 cm

Fluxo luminoso	500lm
Corrente da Lâmpada	0.051A
Intensidade máx. da luz	1000cd
Índice de reprodução cromática	93
Potência	7,3W
Consumo de energia/1000 h	8kWh

Variante	Art. n.º	EUR
○ Prateado 2700K	<b>1005294</b>	<b>24,50</b>
○ Prateado 3000K	<b>1005295</b>	<b>24,50</b>
○ Prateado 4000K	<b>1005296</b>	<b>24,50</b>

### LED A60 E27, tunable 2700-6500K, smart

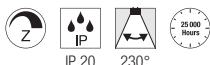

220-240V ~50/60Hz  
Potência: 9W  
Material: poliamida 66 (PA 66)  
Ø: 6 cm C: 11 cm

Fluxo luminoso	800lm
Corrente da Lâmpada	0.067A
Índice de reprodução cromática	92
Potência	9W
Consumo de energia/1000 h	9kWh

Variante	Art. n.º	EUR
○ Branco 2700-6500K	<b>1005317</b>	<b>32,00</b>

### LED A60 E27, RGBW, smart

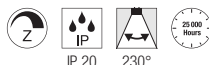

220-240V ~50/60Hz  
Potência: 9W  
Material: poliamida 66 (PA 66)/  
policarbonato (PC)  
Ø: 6 cm C: 11 cm

Fluxo luminoso	800lm
Corrente da Lâmpada	0.073A
Índice de reprodução cromática	92
Potência	9W
Consumo de energia/1000 h	9kWh

Variante	Art. n.º	EUR
○ Branco	<b>1005318</b>	<b>44,50</b>

### LED A60 E27

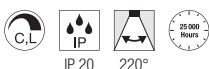

220-240V ~50/60Hz  
Potência: 9W  
Material: plástico  
Ø: 6 cm C: 11 cm

Fluxo luminoso	800lm
Corrente da Lâmpada	0.048A
Índice de reprodução cromática	90
Potência	9W
Consumo de energia/1000 h	9kWh

Variante	Art. n.º	EUR
○ Branco 2700K	<b>1005301</b>	<b>7,35</b>

### LED A60 E27

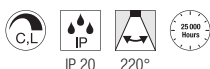

220-240V ~50/60Hz  
Potência: 13,2W  
Material: plástico  
Ø: 6 cm C: 12 cm

Fluxo luminoso	1300lm
Corrente da Lâmpada	0.062A
Índice de reprodução cromática	93
Potência	13,2W
Consumo de energia/1000 h	13kWh

Variante	Art. n.º	EUR
○ Branco 2700K	<b>1005302</b>	<b>12,25</b>

### LED A60 E27



220-240V ~50/60Hz  
Potência: 7,5W  
Material: vidro  
Ø: 6 cm C: 10,5 cm

Fluxo luminoso	800lm
Corrente da Lâmpada	0.038A
Índice de reprodução cromática	93
Potência	7,5W
Consumo de energia/1000 h	8kWh

Variante	Art. n.º	EUR
○ Transparente 2700K	<b>1005303</b>	<b>9,60</b>



**LED T38**  
E27

220-240V ~50/60Hz  
Potência: 8W  
Material: plástico  
Ø: 3,8 cm C: 11,6 cm

Fluxo luminoso	880lm
Corrente da Lâmpada	0.035A
Índice de reprodução cromática	94
Potência	8W
Consumo de energia/1000 h	8kWh

Variante	Art. n.º	EUR
<input type="radio"/> Branco		
<input type="radio"/> 3000K	<b>1005289</b>	<b>10,25</b>
<input type="radio"/> Branco		
<input type="radio"/> 4000K	<b>1005290</b>	<b>10,25</b>

**LED T45**  
E27

220-240V ~50/60Hz  
Potência: 13,5W  
Material: plástico  
Ø: 4,5 cm C: 14 cm

Fluxo luminoso	1520lm
Corrente da Lâmpada	0.06A
Índice de reprodução cromática	94
Potência	13,5W
Consumo de energia/1000 h	14kWh

Variante	Art. n.º	EUR
<input type="radio"/> Branco		
<input type="radio"/> 3000K	<b>1005307</b>	<b>12,50</b>
<input type="radio"/> Branco		
<input type="radio"/> 4000K	<b>1005308</b>	<b>12,50</b>

**LED ST64**  
E27

220-240V ~50/60Hz  
Potência: 7,5W  
Material: vidro  
Ø: 6,4 cm C: 14,5 cm

Fluxo luminoso	700lm
Corrente da Lâmpada	0.038A
Índice de reprodução cromática	90
Potência	7,5W
Consumo de energia/1000 h	8kWh

Variante	Art. n.º	EUR
<input checked="" type="radio"/> Dourado		
<input type="radio"/> 2500K	<b>1005265</b>	<b>26,50</b>

**LED A60**  
E27, Mirrorhead, Chrom

220-240V ~50/60Hz  
Potência: 7,5W  
Material: vidro  
Ø: 6 cm C: 10,5 cm

Fluxo luminoso	720lm
Corrente da Lâmpada	0.038A
Índice de reprodução cromática	92
Potência	7,5W
Consumo de energia/1000 h	8kWh

Variante	Art. n.º	EUR
<input checked="" type="radio"/> Cromado		
<input type="radio"/> 2700K	<b>1005305</b>	<b>19,00</b>

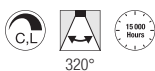
**LED ST58**  
E27

220-240V ~50/60Hz  
Potência: 7,5W  
Material: vidro  
Ø: 5,8 cm C: 14,2 cm

Fluxo luminoso	800lm
Corrente da Lâmpada	0.038A
Índice de reprodução cromática	93
Potência	7,5W
Consumo de energia/1000 h	8kWh

Variante	Art. n.º	EUR
<input type="radio"/> Transparente		
<input type="radio"/> 2700K	<b>1005268</b>	<b>12,25</b>

**LED G125**  
E27

220-240V ~50/60Hz  
Potência: 7,5W  
Material: vidro  
Ø: 12,5 cm C: 17,8 cm

Fluxo luminoso	800lm
Corrente da Lâmpada	0.038A
Índice de reprodução cromática	93
Potência	7,5W
Consumo de energia/1000 h	8kWh

Variante	Art. n.º	EUR
<input type="radio"/> Transparente		
<input type="radio"/> 2700K	<b>1005310</b>	<b>18,50</b>



1007300 151

1007308 151

1002913 189

TRANSFORMADOR  
TENSEO 12V AC | 868TRANSFORMADOR  
12VAC | 868

INTERFACE DALI | 868



CONVERSOR | 868

REGULADOR  
UNIVERSAL DALI | 869CONTROLADOR  
DALI | 869

CONTROLADOR | 869

TRANSFORMADOR  
PARA FONTES DE LUZ  
LED | 869, 870, 871TRANSFORMADOR  
REGULÁVEL PARA 12  
OU 24V DC | 871, 872DRIVER PARA FONTE  
DE LUZ LED | 870,  
872, 875, 876, 877DRIVER LED  
REGULÁVEL | 871,  
872, 873, 874, 875MÓDULO RF |  
874, 875GANCHO PARA  
TETO | 878BRAÇADEIRA DE  
CABO | 878ROSETA PARA TETO  
GLENOS® | 878CABO EM  
TECIDO | 878CABO DE  
3 CONDUTORES | 878CABO DE AÇO PARA  
SUSPENSÕES | 878BATENTE PARA CABO  
DE AÇO | 879EXTENSÃO DE  
CABO | 879CAIXA DE LIGAÇÃO  
PARA DERIVAÇÕES  
EM SÉRIE | 879FITA ADESIVA DE  
DUPLA FACE | 879CAIXA DE LIGAÇÃO  
COM CASQUILHO  
PARA LED GU10 | 880CAIXA DE LIGAÇÃO  
COM CASQUILHO  
GU10 | 880CASQUILHO  
GU10 | 880LIGADOR  
ESTANQUE | 881CAIXA DE LIGAÇÕES  
ESTANQUE EM T | 881LIGADOR ESTANQUE  
EM Y | 881

**TRANSFORMADOR  
TENSEO**  
12V CA | 50 VA convencional



220-240V ~50/60Hz  
A: 11 cm  
Ø: 11,1 cm  
Material: aço/bronze

Tensão de saída	12V AC
Potência até	60W
Proteção térmica	130°C
Número de saídas secundárias	1

Variante	Art. n.º	EUR
● Preto	1002691	111,00
○ Branco	1002692	111,00
● Cromado	1002693	115,00

**TRANSFORMADOR  
TENSEO**  
12V CA | 105 VA convencional



220-240V ~50/60Hz  
A: 11 cm  
Ø: 11,1 cm  
Material: bronze/vidro

Tensão de saída	12V AC
Potência até	105W
Proteção térmica	130°C
Número de saídas secundárias	1

Variante	Art. n.º	EUR
○ Branco	138981	135,00
● Cromado	138982	147,00

**TRANSFORMADOR  
TENSEO**  
12V CA | 210 VA convencional



220-240V ~50/60Hz  
A: 11 cm  
Ø: 13,5 cm  
Material: aço/bronze

Tensão de saída	12V AC
Potência até	210W
Proteção térmica	130°C
Número de saídas secundárias	1

Variante	Art. n.º	EUR
○ Branco	138991	204,00
● Cromado	138992	213,00

**TRANSFORMADOR**  
60VA | 12V AC



230V ~50Hz  
C: 10,5 cm L: 3,3 cm A: 2,2 cm  
Material: policarbonato (PC)

Tensão de saída	12V AC
Potência de	10W
Potência até	60W
Fator de potência do aparelho de serviço	0.98
Proteção térmica	110°C
Número de saídas secundárias	1

Variante	Art. n.º	EUR
○ Branco	461060	28,00

**INTERFACE DALI**  
1-10V + on/off



250V AC  
C: 5,85 cm L: 3,25 cm A: 1,5 cm  
Material: plástico

- Para controlar balastros eletrónicos com entrada de controlo de 1-10V
- Isolamento galvânico da entrada DALI e saída de 1-10V

Tensão de saída	250V AC
Potência até	1000W

Variante	Art. n.º	EUR
● Cinzento	1002218	269,00

**CONVERSOR**  
Phase dim -> DALI



100-240V ~50/60Hz  
C: 4,6 cm L: 4,5 cm A: 2 cm  
Material: policarbonato (PC)

Tensão de saída	100-240V AC
Potência de	0W
Potência até	200W

Variante	Art. n.º	EUR
○ Branco	1006452	79,00



## TRANSFORMADOR DALI UNIVERSAL 10-300W



230V AC  
C: 12,02 cm L: 3,02 cm A: 2,16 cm  
Material: plástico

- Adequado para carga R, L, C, graças à deteção automática de carga. Consumo de corrente DALI: 6 mA

Tensão de saída	230V AC
Potência de	10W
Potência até	300W

Variante	Art. n.º	EUR
● Cinzento	1002221	359,00

## CONVERSOR DALI 24V DC

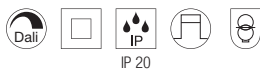

10V-24V DC  
C: 11,6 cm L: 4,2 cm A: 1,8 cm  
Material: policarbonato (PC)

Tensão de saída	10-24V DC
Número de saídas secundárias	1

Variante	Art. n.º	EUR
○ Branco/Cinzento	1003106	64,00

## CONTROLADOR LED Stip CCT / RGBW



NEW



12 V/24 V CC  
C: 14,5 cm L: 4,65 cm A: 1,6 cm  
Material: policarbonato (PC)

Tensão de saída	12-24V DC
Potência de	48W
Potência até	96W
Proteção térmica	100°C

Variante	Art. n.º	EUR
○ Branco	1006348 ●	80,00

## TRANSFORMADOR PARA LED 15W | 12V

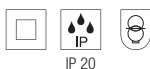

200-240V ~50/60Hz  
A: 2,5 cm  
Ø: 5,5 cm  
Material: policarbonato (PC)

Tensão de saída	12V DC
Potência de	0W
Potência até	15W
Fator de potência do aparelho de serviço	0,9
Proteção térmica	110°C
Número de saídas secundárias	1

Variante	Art. n.º	EUR
○ Branco	1005444	29,50

## TRANSFORMADOR PARA LED 15W | 24V

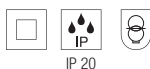

200-240V ~50/60Hz  
A: 2,2 cm  
Ø: 5,5 cm  
Material: policarbonato (PC)

Tensão de saída	24V DC
Potência de	0W
Potência até	15W
Fator de potência do aparelho de serviço	0,9
Proteção térmica	110°C
Número de saídas secundárias	1

Variante	Art. n.º	EUR
○ Branco	1005445	29,50

## TRANSFORMADOR PARA LED 20W | 12/24V

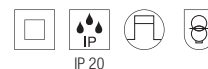

220-240V ~50/60Hz  
C: 11,5 cm L: 4,1 cm A: 2,5 cm  
Material: policarbonato (PC)

Tensão de saída	12/24V DC
Potência de	0W
Potência até	18W/20W
Fator de potência do aparelho de serviço	0,95
Proteção térmica	110°C
Número de saídas secundárias	1

Variante	Art. n.º	EUR
○ Branco	1005381	39,50

**TRANSFORMADOR PARA LED**  
30W | 24V DC incl. alívio de tensão



220-240V ~50/60Hz  
C: 30 cm L: 3 cm A: 1,6 cm  
Material: policarbonato (PC)

Tensão de saída	24V DC
Potência de	0W
Potência até	30W
Fator de potência do aparelho de serviço	0.95
Proteção térmica	110°C
Número de saídas secundárias	1

Variante	Art. n.º	EUR
<input type="radio"/> Branco	1007250	50,00

**TRANSFORMADOR PARA LED**  
100W | 24V DC incl. alívio de tensão



220-240V ~50/60Hz  
C: 35 cm L: 3 cm A: 1,8 cm  
Material: policarbonato (PC)

Tensão de saída	24V DC
Potência de	0W
Potência até	100W
Fator de potência do aparelho de serviço	0.95
Proteção térmica	110°C
Número de saídas secundárias	1

Variante	Art. n.º	EUR
<input type="radio"/> Branco	1007251	80,00

**TRANSFORMADOR PARA LED**  
150W | 24V DC incl. alívio de tensão



220-240V ~50/60Hz  
C: 35 cm L: 3 cm A: 1,8 cm  
Material: policarbonato (PC)

Tensão de saída	24V DC
Potência de	0W
Potência até	150W
Fator de potência do aparelho de serviço	0.95
Proteção térmica	110°C
Número de saídas secundárias	1

Variante	Art. n.º	EUR
<input type="radio"/> Branco	1007252	100,00

**TRANSFORMADOR PARA LED**  
250W | 24V DC incl. alívio de tensão



220-240V ~50/60Hz  
C: 40 cm L: 4 cm A: 2,2 cm  
Material: policarbonato (PC)

Tensão de saída	24V DC
Potência de	0W
Potência até	250W
Fator de potência do aparelho de serviço	0.95
Proteção térmica	110°C
Número de saídas secundárias	1

Variante	Art. n.º	EUR
<input type="radio"/> Branco	1007253	120,00

**TRANSFORMADOR PARA LED**  
25W | 24V

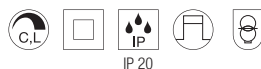

220-240V ~50/60Hz  
C: 12,8 cm L: 5,2 cm A: 3 cm  
Material: policarbonato (PC)/  
policarbonato (PC)

Tensão de saída	24V DC
Potência de	9.6W
Potência até	25W
Fator de potência do aparelho de serviço	0.95
Proteção térmica	110°C
Número de saídas secundárias	1

Variante	Art. n.º	EUR
<input type="radio"/> Branco/Cinzento	1006336	35,00

**TRANSFORMADOR PARA LED**  
50W | 24V

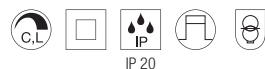

220-240V ~50/60Hz  
C: 18,4 cm L: 6,1 cm A: 3,2 cm  
Material: policarbonato (PC)/  
policarbonato (PC)

Tensão de saída	24V DC
Potência de	12W
Potência até	50W
Fator de potência do aparelho de serviço	0.95
Proteção térmica	110°C
Número de saídas secundárias	1

Variante	Art. n.º	EUR
<input type="radio"/> Branco/Azul	1003104	49,50

**TRANSFORMADOR PARA LED**  
100W | 24V DC

220-240V ~50/60Hz  
C: 21 cm L: 6,7 cm A: 3,4 cm  
Material: policarbonato (PC)/  
policarbonato (PC)

Tensão de saída	24V DC
Potência de	33W
Potência até	100W
Fator de potência do aparelho de serviço	0.95
Proteção térmica	110°C
Número de saídas secundárias	1

Variante	Art. n.º	EUR
<input checked="" type="radio"/> Branco/Azul	1003105	121,00

**TRANSFORMADOR PARA LED**  
30W | 24V DC DALI regulável  
incl. alívio de tensão

220-240V ~50/60Hz  
C: 30 cm L: 3 cm A: 1,6 cm  
Material: policarbonato (PC)

Tensão de saída	24V DC
Potência de	12W
Potência até	30W
Fator de potência do aparelho de serviço	0.95
Proteção térmica	110°C
Número de saídas secundárias	1

Variante	Art. n.º	EUR
<input type="radio"/> Branco	1007254	60,00

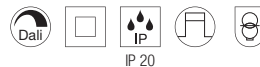
**TRANSFORMADOR PARA LED**  
100W | 24V DC DALI regulável  
incl. alívio de tensão

220-240V ~50/60Hz  
C: 35 cm L: 3 cm A: 1,8 cm  
Material: policarbonato (PC)

Tensão de saída	24V DC
Potência de	30W
Potência até	100W
Fator de potência do aparelho de serviço	0.95
Proteção térmica	110°C
Número de saídas secundárias	1

Variante	Art. n.º	EUR
<input type="radio"/> Branco	1007255	110,00

**TRANSFORMADOR PARA LED**  
150W | 24V DC DALI regulável  
incl. alívio de tensão

220-240V ~50/60Hz  
C: 35 cm L: 3 cm A: 1,8 cm  
Material: policarbonato (PC)

Tensão de saída	24V DC
Potência de	45W
Potência até	150W
Fator de potência do aparelho de serviço	0.95
Proteção térmica	110°C
Número de saídas secundárias	1

Variante	Art. n.º	EUR
<input type="radio"/> Branco	1007256	140,00

**TRANSFORMADOR PARA LED**  
250W | 24V DC DALI regulável  
incl. alívio de tensão

220-240V ~50/60Hz  
C: 40 cm L: 4 cm A: 2,2 cm  
Material: policarbonato (PC)

Tensão de saída	24V DC
Potência de	75W
Potência até	250W
Fator de potência do aparelho de serviço	0.95
Proteção térmica	110°C
Número de saídas secundárias	1

Variante	Art. n.º	EUR
<input type="radio"/> Branco	1007257	160,00

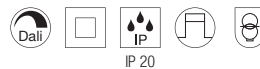
**TRANSFORMADOR PARA LED**  
60W | DALI, 24V, 2 canais DALI  
regulável

220-240V ~50/60Hz  
C: 20,2 cm L: 5,8 cm A: 3 cm  
Material: policarbonato (PC)

Tensão de saída	24V DC
Potência de	5W
Potência até	60W
Fator de potência do aparelho de serviço	0.95
Proteção térmica	110°C
Número de saídas secundárias	2

Variante	Art. n.º	EUR
<input type="radio"/> Branco	1006133	153,00

**TRANSFORMADOR PARA LED**  
100W | 24V | 2 canais DALI regulável

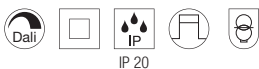

220-240V ~50/60Hz  
C: 34,7 cm L: 4 cm A: 2,2 cm  
Material: policarbonato (PC)

Potência de	5W
Potência até	100W
Fator de potência do aparelho de serviço	0.95
Proteção térmica	110°C
Número de saídas secundárias	2

Variante	Art. n.º	EUR
<input type="radio"/> Branco	1006134	184,00

**DRIVER PARA LED**  
10W | 200 mA | regulável  
incl. alívio de tensão

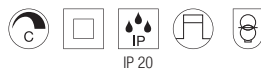

220-240V ~50/60Hz  
C: 8,5 cm L: 4,1 cm A: 2,2 cm  
Material: policarbonato (PC)

Tensão de saída	30-42V DC
Potência de	6W
Potência até	8.4W
Fator de potência do aparelho de serviço	0.9
Proteção térmica	110°C
Número de saídas secundárias	1

Variante	Art. n.º	EUR
<input type="radio"/> Branco	1007215	35,00

**DRIVER PARA LED**  
6W | 350mA | Regulável



220-240V ~50/60Hz  
C: 6,3 cm L: 4 cm A: 2,3 cm  
Material: policarbonato (PC)

Tensão de saída	10-17V DC
Potência de	3.5W
Potência até	5.9W
Fator de potência do aparelho de serviço	0.9
Proteção térmica	110°C
Número de saídas secundárias	1

Variante	Art. n.º	EUR
<input type="radio"/> Branco	1002791	28,50

**DRIVER PARA LED**  
20W | 350mA | Regulável

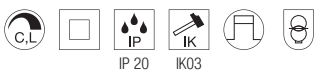

220-240V 0/~50/60Hz  
C: 11,6 cm L: 4,1 cm A: 2,5 cm  
Material: policarbonato (PC)

Tensão de saída	28-50V DC
Potência de	9.8W
Potência até	17.5W
Fator de potência do aparelho de serviço	0.95
Proteção térmica	110°C
Número de saídas secundárias	1

Variante	Art. n.º	EUR
<input type="radio"/> Branco	1007228	40,00

**DRIVER PARA LED**  
20W | 350mA/500mA | PHASE

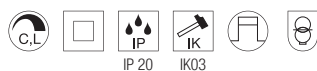

220-240V 0/~50/60Hz  
C: 11,6 cm L: 4,1 cm A: 2,5 cm  
Material: policarbonato (PC)

Tensão de saída	10-30V DC
Potência de	3.5W
Potência até	15W
Fator de potência do aparelho de serviço	0.95
Proteção térmica	110°C
Número de saídas secundárias	1

Variante	Art. n.º	EUR
<input type="radio"/> Branco	1007227	40,00

**DRIVER PARA LED**  
700mA | PHASE

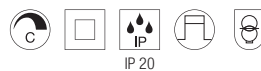

220-240V ~50/60Hz  
C: 8,5 cm L: 4,1 cm A: 2,2 cm  
Material: policarbonato (PC)

Tensão de saída	8.6-12.9V DC
Potência de	6W
Potência até	9W
Fator de potência do aparelho de serviço	0.9
Proteção térmica	110°C
Número de saídas secundárias	1

Variante	Art. n.º	EUR
<input type="radio"/> Branco	1007213	35,00





**DRIVER PARA LED**  
20W | 700mA | Regulável

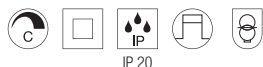

200-240V ~50/60Hz  
C: 11,5 cm L: 4,1 cm A: 2,5 cm  
Material: policarbonato (PC)

Tensão de saída	18-26V DC
Potência de	12.6W
Potência até	18.2W
Fator de potência do aparelho de serviço	0.9
Proteção térmica	110°C
Número de saídas secundárias	1

Variante	Art. n.º	EUR
<input type="radio"/> Branco	1006202	34,00

**DRIVER PARA LED**  
40W | 700mA | Regulável

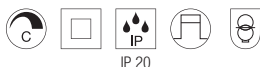

200-240V ~50/60Hz  
C: 14,5 cm L: 4 cm A: 3 cm  
Material: policarbonato (PC)

Tensão de saída	32-54V DC
Potência de	22.4W
Potência até	37.8W
Fator de potência do aparelho de serviço	0.9
Proteção térmica	110°C
Número de saídas secundárias	1

Variante	Art. n.º	EUR
<input type="radio"/> Branco	1005446	45,00

**DRIVER PARA LED**  
40W | 1050mA | Regulável

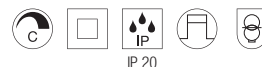

220-240V ~50/60Hz  
C: 16,6 cm L: 5,2 cm A: 2,4 cm  
Material: policarbonato (PC)

Tensão de saída	22-43V DC
Potência de	23W
Potência até	45W
Fator de potência do aparelho de serviço	0.95
Proteção térmica	110°C
Número de saídas secundárias	1

Variante	Art. n.º	EUR
<input type="radio"/> Branco	464804	57,00

**DRIVER PARA LED**  
40W | 1000mA | Regulável

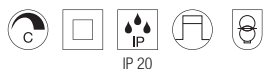

220-240V ~50/60Hz  
C: 14,5 cm L: 4 cm A: 3 cm  
Material: policarbonato (PC)

Tensão de saída	25-40V DC
Potência de	26.3W
Potência até	42W
Fator de potência do aparelho de serviço	0.9
Proteção térmica	110°C
Número de saídas secundárias	1

Variante	Art. n.º	EUR
<input type="radio"/> Branco	1005387	57,00

**DRIVER PARA LED**  
25W | 150-700mA | DALI regulável



220-240 V 0/~50/60Hz  
C: 11,9 cm L: 5,2 cm A: 2,25 cm  
Material: policarbonato (PC)

Tensão de saída	2-50V DC
Potência de	0.3W
Potência até	25W
Fator de potência do aparelho de serviço	0.95
Proteção térmica	110°C
Número de saídas secundárias	1

Variante	Art. n.º	EUR
<input type="radio"/> Branco	1007229	70,00

**DRIVER PARA LED**  
25W | 150-300mA | DALI regulável



220-240V ~50/60Hz  
C: 14,18 cm L: 4,38 cm A: 3 cm  
Material: policarbonato (PC)

Tensão de saída	10-40V DC
Potência de	1.5W
Potência até	12W
Fator de potência do aparelho de serviço	0.9
Proteção térmica	110°C
Número de saídas secundárias	1

Variante	Art. n.º	EUR
<input type="radio"/> Branco	1006456	85,00

## MÓDULO RF para controlador DALI



NEW



C: 4,3 cm L: 3,1 cm A: 1,2 cm  
Material: policarbonato (PC)

- Zigbee 3.0 Single Color

## MÓDULO RF para controlador DALI



NEW

C: 4,3 cm L: 3,1 cm A: 1,2 cm  
Material: policarbonato (PC)

- Casambi

## DRIVER PARA LED 12W | 250mA DALI regulável com interface RF



NEW



220-240V ~50/60Hz  
C: 14,18 cm L: 4,38 cm A: 3 cm  
Material: policarbonato (PC)

Tensão de saída	10-40V DC
Potência de	1,5W
Potência até	12W
Fator de potência do aparelho de serviço	0,9
Proteção térmica	110°C
Número de saídas secundárias	1

Variante	Art. n.º	EUR
<input type="radio"/> Branco	1006199	38,00

Variante	Art. n.º	EUR
<input type="radio"/> Branco	1006454	129,00

Variante	Art. n.º	EUR
<input type="radio"/> Branco	1006194	85,00

## DRIVER PARA LED 40W | 500mA DALI regulável com interface RF



NEW



220-240V ~50/60Hz  
C: 12,3 cm L: 7,9 cm A: 3 cm  
Material: policarbonato (PC)

Tensão de saída	10-42V DC
Potência de	5W
Potência até	42W
Fator de potência do aparelho de serviço	0,95
Proteção térmica	110°C
Número de saídas secundárias	1

Variante	Art. n.º	EUR
<input type="radio"/> Branco	1006195	100,00

## DRIVER PARA LED 40W | 700mA DALI regulável com interface RF



NEW



220-240V ~50/60Hz  
C: 12,3 cm L: 7,9 cm A: 3 cm  
Material: policarbonato (PC)

Tensão de saída	10-42V DC
Potência de	5W
Potência até	42W
Fator de potência do aparelho de serviço	0,95
Proteção térmica	110°C
Número de saídas secundárias	1

Variante	Art. n.º	EUR
<input type="radio"/> Branco	1006196	100,00

## DRIVER PARA LED 40W | 1050mA DALI regulável com interface RF



NEW



220-240V ~50/60Hz  
C: 12,3 cm L: 7,9 cm A: 3 cm  
Material: policarbonato (PC)

Tensão de saída	10-40V DC
Potência de	5W
Potência até	42W
Fator de potência do aparelho de serviço	0,95
Proteção térmica	110°C
Número de saídas secundárias	1

Variante	Art. n.º	EUR
<input type="radio"/> Branco	1006197	100,00



### DRIVER PARA LED

20W | 250-700mA 1-10V/  
DALI regulável



220-240V ~50/60Hz  
C: 15 cm L: 5,2 cm A: 2,8 cm  
Material: policarbonato (PC)

Tensão de saída	6-60V DC
Potência de	1.5W
Potência até	20W
Fator de potência do aparelho de serviço	0.9
Proteção térmica	110°C
Número de saídas secundárias	1

Variante	Art. n.º	EUR
<input type="radio"/> Branco	1002423	85,00

### DRIVER PARA LED

40W | 500-1050mA 1-10V/  
DALI regulável



220-240V ~50/60Hz  
C: 12,3 cm L: 7,9 cm A: 2,4 cm  
Material: policarbonato (PC)

Tensão de saída	9-58V DC
Potência de	4.5W
Potência até	40W
Fator de potência do aparelho de serviço	0.9
Proteção térmica	110°C
Número de saídas secundárias	1

Variante	Art. n.º	EUR
<input type="radio"/> Branco	1002424	90,00

### DRIVER PARA LED

50W | 700-1500mA 1-10V/  
DALI regulável

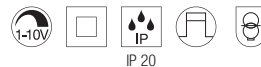

220-240V ~50/60Hz  
C: 12,3 cm L: 7,9 cm A: 2,4 cm  
Material: policarbonato (PC)

Tensão de saída	6-58V DC
Potência de	4.2W
Potência até	50W
Fator de potência do aparelho de serviço	0.9
Proteção térmica	110°C
Número de saídas secundárias	1

Variante	Art. n.º	EUR
<input type="radio"/> Branco	1002425	96,00

### DRIVER PARA LED

40W | 1050mA DALI CCT tunable



NEW

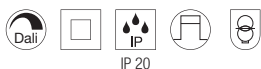

220-240V ~50/60Hz  
C: 12,3 cm L: 7,9 cm A: 3 cm  
Material: policarbonato (PC)

Tensão de saída	10-40V DC
Potência de	5W
Potência até	42W
Fator de potência do aparelho de serviço	0.9
Proteção térmica	110°C
Número de saídas secundárias	7

Variante	Art. n.º	EUR
<input type="radio"/> Branco	1006198	155,00

### MÓDULO RF

para controlador DALI



NEW



C: 4,3 cm L: 3,1 cm A: 1,2 cm  
Material: policarbonato (PC)

- Zigbee 3.0 Dual Color

Variante	Art. n.º	EUR
<input type="radio"/> Branco	1006455	38,00

### DRIVER PARA LED

10W | 250mA



220-240V ~50/60Hz  
C: 6,5 cm L: 3,9 cm A: 2 cm  
Material: policarbonato (PC)

Tensão de saída	26-40V DC
Potência de	6.5W
Potência até	10W
Fator de potência do aparelho de serviço	0.9
Proteção térmica	110°C
Número de saídas secundárias	1

Variante	Art. n.º	EUR
<input type="radio"/> Branco	1004780	26,00

**DRIVER PARA LED**  
3W | 350mA



100-240V ~50/60Hz  
C: 6,5 cm L: 2,9 cm A: 1,8 cm  
Material: policarbonato (PC)

Tensão de saída	2,7-10V DC
Potência de	1W
Potência até	3,5W
Fator de potência do aparelho de serviço	0,4
Proteção térmica	110°C
Número de saídas secundárias	1

Variante	Art. n.º	EUR
<input type="radio"/> Branco	1005248	15,00

**DRIVER PARA LED**  
3W | 350mA incl. conector AMP

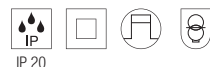

100-240V ~50/60Hz  
C: 6,5 cm L: 2,9 cm A: 1,8 cm  
Material: policarbonato (PC)

Tensão de saída	2,7-10V DC
Potência de	1W
Potência até	3,5W
Fator de potência do aparelho de serviço	0,4
Proteção térmica	110°C
Número de saídas secundárias	1

Variante	Art. n.º	EUR
<input type="radio"/> Branco	1007270	19,80

**DRIVER PARA LED**  
20W | 350mA



220-240 V 0/~50/60Hz  
C: 11,6 cm L: 4,1 cm A: 2,5 cm  
Material: policarbonato (PC)

Tensão de saída	2-54V DC
Potência de	0,7W
Potência até	19W
Fator de potência do aparelho de serviço	0,95
Proteção térmica	110°C
Número de saídas secundárias	1

Variante	Art. n.º	EUR
<input type="radio"/> Branco	1007225	30,00

**DRIVER PARA LED**  
21W | 500 mA incl. alívio de tensão



220-240 V 0/~50/60Hz  
C: 11,6 cm L: 4,1 cm A: 2,5 cm  
Material: policarbonato (PC)

Tensão de saída	2-42V DC
Potência de	1W
Potência até	21W
Fator de potência do aparelho de serviço	0,95
Proteção térmica	110°C
Número de saídas secundárias	1

Variante	Art. n.º	EUR
<input type="radio"/> Branco	1007226	30,00

**DRIVER PARA LED**  
3W | 700 mA incl. alívio de tensão

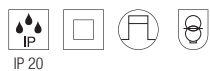

100-240V ~50/60Hz  
C: 6,5 cm L: 2,9 cm A: 1,8 cm  
Material: policarbonato (PC)

Tensão de saída	2,7-4V DC
Potência de	1,9W
Potência até	2,8W
Fator de potência do aparelho de serviço	0,4
Proteção térmica	110°C
Número de saídas secundárias	1

Variante	Art. n.º	EUR
<input type="radio"/> Branco	1007216	23,00

**DRIVER PARA LED**  
30W | 700mA



220-240V ~50/60Hz  
C: 14,7 cm L: 4,3 cm A: 3 cm  
Material: policarbonato (PC)

Tensão de saída	30-42V DC
Potência de	21W
Potência até	29,5W
Fator de potência do aparelho de serviço	0,9
Proteção térmica	110°C
Número de saídas secundárias	1

Variante	Art. n.º	EUR
<input type="radio"/> Branco	1004781	30,75



### TRANSFORMADOR PARA LED 40W | 1050mA



220-240V ~50/60Hz  
C: 14,7 cm L: 4,3 cm A: 3 cm  
Material: policarbonato (PC)

Tensão de saída	30-42V DC
Potência de	31.5W
Potência até	44W
Fator de potência do aparelho de serviço	0.9
Proteção térmica	110°C
Número de saídas secundárias	1

Variante	Art. n.º	EUR
<input type="radio"/> Branco	1004782	36,00

### TRANSFORMADOR PARA LED 40W | 700/900/1000mA



120-277V ~50/60Hz  
C: 12,3 cm L: 7,9 cm A: 3 cm  
Material: policarbonato (PC)

Tensão de saída	28-52V DC
Potência de	19.6W
Potência até	40W
Fator de potência do aparelho de serviço	0.9
Proteção térmica	110°C
Número de saídas secundárias	3

Variante	Art. n.º	EUR
<input type="radio"/> Branco	1006120	57,00

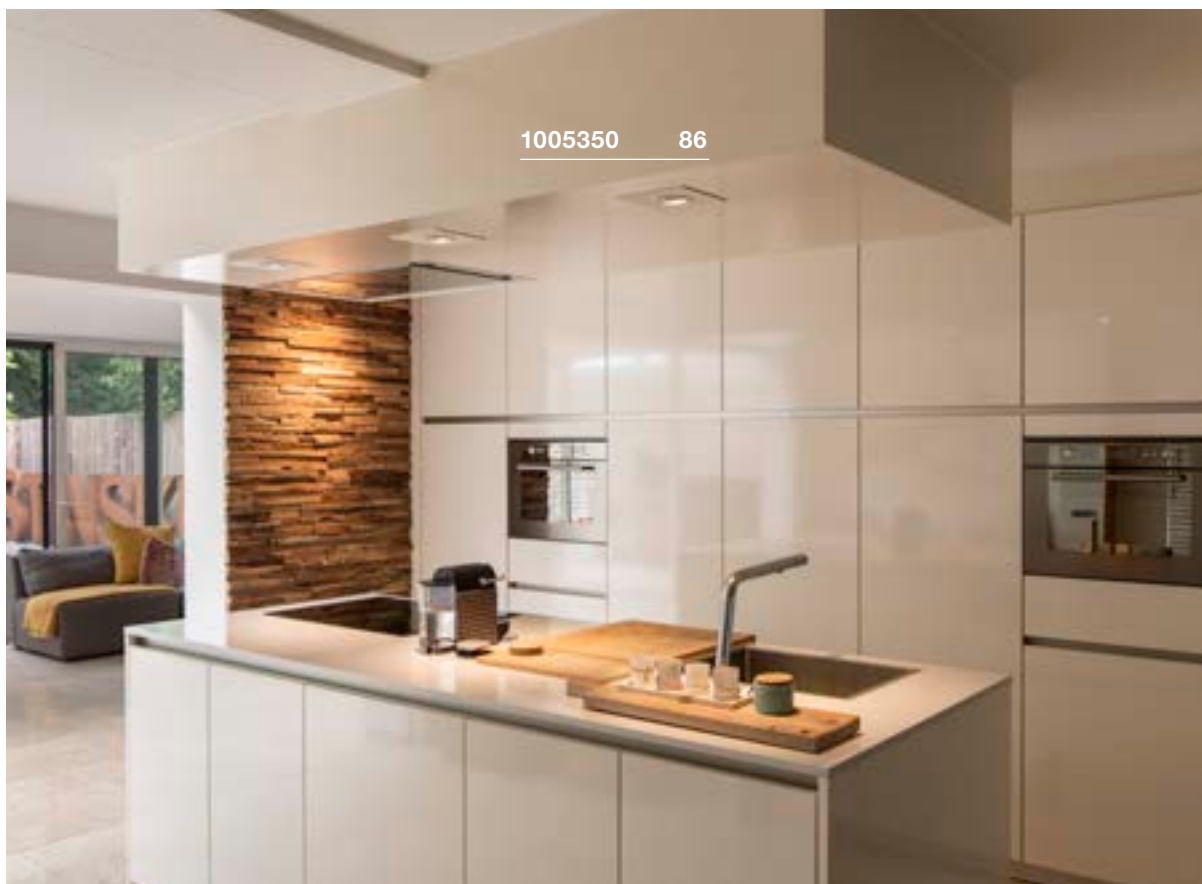

## GANCHO PARA TETO



C: 4,6 cm  
 Ø: 1,8 cm  
 Material: alumínio

Variante	Art. n.º	EUR
● Preto	132670	19,20
○ Branco	132671	19,20

## BRAÇADEIRA DE CABOS



C: 3,1 cm  
 Ø: 1,4 cm  
 Material: alumínio

Variante	Art. n.º	EUR
● Preto	132680	12,50
○ Branco	132681	12,50

## GLENOS® Roseta para teto



220-240V ~50/60Hz  
 C: 8,5 cm L: 8,5 cm A: 2,7 cm  
 Material: alumínio

Tensão nominal	220-240V ~50/60Hz
Carga de corrente máx.	8.5A

Variante	Art. n.º	EUR
● Preto	210060	32,00
○ Branco	210061	32,00
● Cinzento	210064	32,00

## CABO EM TECIDO 3 pinos, 10 m



C: 1000 cm  
 Ø: 0,6 cm  
 Material: cloreto de polivinilo (PVC)/têxtil

Tensão máx. 300V ACV

Variante	Art. n.º	EUR
● Preto	961270	62,00

## CABO 3 pinos, 3 x 0,75 mm<sup>2</sup>, 10 m



C: 1000 cm

Tensão máx. 300V ACV

Variante	Art. n.º	EUR
○ Transparente	961250	27,25

## SUSPENSÃO DE CABOS DE AÇO



C: 500 cm  
 Ø: 0,15 cm  
 Material: aço/plástico

Variante	Art. n.º	EUR
○ Prateado	961037	20,50



## BATENTE PARA CABO DE AÇO



IP 20

Ø: 0,7 cm  
Material: aço

## EXTENSÃO DE CABO



IP 20

C: 100 cm  
Material: plástico

- Com ficha elétrica AMP e acoplamento

Carga de corrente máx. 0.35A

Variante	Art. n.º	EUR
● Cinzento	961034	29,00

Variante	Art. n.º	EUR
○ Branco	111861	7,75

CAIXA DE LIGAÇÃO PARA DERIVAÇÕES EM SÉRIE  
3 saídas

IP 20

C: 5,2 cm L: 1,4 cm A: 1,3 cm  
Material: plástico

## FITA ADESIVA DE DUPLA FACE



C: 300 cm L: 0,9 cm

Carga de corrente máx. 0.35A

Variante	Art. n.º	EUR
● Preto	111850	13,40

Variante	Art. n.º	EUR
○ Transparente	220000	15,00



1000735 699

### GU10 LED CONNECTION BOX com base, máx. 10 W

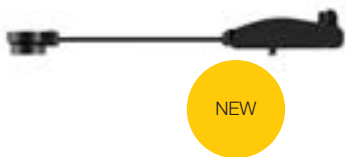

C: 3,8 cm L: 3,1 cm A: 1,7 cm  
Material: plástico

### GU10 CONNECTION BOX com base, universal



220-240V ~50/60Hz  
C: 2,8 cm L: 2,8 cm A: 3,7 cm  
Material: cerâmica/plástico

- Comprimento do cabo 15 cm

### CASQUILHO GU10



230V ~50Hz  
A: 1,6 cm  
Ø: 2,8 cm  
Material: cerâmica

- Comprimento do cabo 15 cm

Tensão nominal 230V ~50Hz

Variante	Art. n.º	EUR
● Preto	1007283	6,00

Variante	Art. n.º	EUR
○ Branco/Preto	1000909	7,75

Variante	Art. n.º	EUR
○ Branco	955135	2,05





### LIGADOR ESTANQUE IP68, 3 pinos



IP 68

230V ~50Hz  
C: 11,5 cm  
Ø: 2,7 cm  
Material: poliamida (PA)

Tensão nominal	230V ~50Hz
Tensão máx.	450V ACV
Carga de corrente máx.	17.5A

Variante	Art. n.º	EUR
● Preto	228730	23,00

### CAIXA DE LIGAÇÕES ESTANQUE EM T IP68, 3 pinos



IP 68

230V ~50Hz  
C: 11 cm L: 6,4 cm A: 3 cm  
Material: poliamida (PA)

Tensão nominal	230V ~50Hz
Tensão máx.	500V DCV
Carga de corrente máx.	17.5A

Variante	Art. n.º	EUR
● Preto	228726	36,00

### LIGADOR ESTANQUE IP68, 5 pinos



IP 68

230V ~50Hz  
C: 13 cm  
Ø: 3,2 cm  
Material: poliamida (PA)

Tensão nominal	230V ~50Hz
Tensão máx.	450V ACV
Carga de corrente máx.	32A

Variante	Art. n.º	EUR
● Preto	228725	17,90

### LIGADOR ESTANQUE EM Y IP68, 5 pinos, DALI



NEW









IP 68

450 V  
C: 18 cm L: 6,3 cm A: 3,3 cm  
Material: poliamida 66 (PA 66)

Tensão nominal	450V
Carga de corrente máx.	16A

Variante	Art. n.º	EUR
● Preto	1006453	35,00

## NUMINOS®





	Luminárias para encastrar .....	83 – 87, 91 – 93
	Luminárias salientes para parede e teto .....	99 – 101
	Luminárias de teto .....	103 – 105
	Luminárias suspensas .....	106 – 109
	Calhas eletrificadas trifásicas .....	110 – 113, 115
	Sistema de 48V .....	469 – 471
	Componentes .....	94 – 95

**Ou configure facilmente online em: [numinos.slv.com](http://numinos.slv.com)**

## NEW TRIA®

	Luminárias para encastrar .....	122 – 147
---	---------------------------------	-----------





## MEDO®

	Luminárias salientes para parede e teto .....	148 – 161
	Luminárias salientes para teto .....	164 – 165
	Luminárias suspensas .....	166 – 167
	Luminárias para encastrar .....	168 – 169

## LALU®

	Luminárias suspensas .....	176 – 183
---	----------------------------	-----------

## ONE®

	Luminárias suspensas .....	186 – 191
	Luminárias salientes para parede e teto .....	192 – 193
	Calhas eletrificadas trifásicas .....	194 – 195
	Luminárias de mesa e de pé .....	196 – 199

Nota: encontra as referencias com 7 dígitos a partir da página 886

<b>111000</b>		117351	262	143021	495
111262	238			143022	495
111292	239	<b>132000</b>		143030	497
111362	145	132020	409	143031	497
111382	145	132021	409	143032	497
111850	879	132024	409	143040	497
111861	879	132600	279, 281, 283, 295, 305, 309, 318	143041	497
		132601	279, 281, 283, 295, 305, 307, 309	143042	497
<b>112000</b>		132605	279, 281, 283, 295, 305, 309	143050	497
112221	227	132610	295, 305	143051	497
112222	227	132611	295, 305	143052	497
112225	227	132660	296	143060	497
112242	234	132661	296	143061	497
112682	227	132662	296	143062	497
112692	227	132670	878	143070	497
112720	238	132671	878	143071	497
112721	238	132680	878	143072	497
112780	238, 239, 240	132681	878	143080	497
112781	238, 239, 240	132690	295	143081	497
112910	220	132691	295	143082	497
112911	220	132835	660	143090	497
				143091	497
<b>113000</b>		<b>133000</b>		143092	497
113140	219	133009	309	143100	497
113141	219	133019	309	143101	497
113150	219	133050	309	143102	497
113151	219	133060	309	143110	497
113160	220	133444	307	143111	497
113161	220	133481	314	143112	497
113170	221	133482	314	143120	279
113171	221	133489	314	143121	279
113262	238	133490	314	143124	279
113292	239	133840	167	143130	497
113492	145	133841	167	143131	497
113512	145	133850	167	143132	497
113540	145	133851	167	143151	497
113541	145			143152	497
113550	145	<b>135000</b>		143160	497
113830	145	135250	153, 157, 161, 165	143161	497
113840	145	135251	153, 157, 161, 165	143162	497
113841	145	135254	153, 157, 161, 165	143169	497
113890	141			143170	497, 499
113891	141	<b>138000</b>		143171	497, 499
113930	257	138981	868	143172	497, 499
113931	257	138982	868	143190	513
113940	257	138991	868	143191	513
113941	257	138992	868	143221	499
113970	141			143230	499
113971	141	<b>139000</b>		143231	499
113976	141	139004	483	143241	499
		139006	484	143251	499
<b>114000</b>		139024	482	143261	499
114420	245	139026	483	143271	499
114421	245	139030	482	143281	499
114426	245	139031	482	143350	521
114430	245	139040	483	143351	521
114431	245	139041	483	143354	521
114436	245	139050	483	143380	497
114440	246	139051	483	143381	497
114441	246	139060	484	143382	497
114450	247	139061	484	143390	513
114451	247	139070	486	143391	513
114480	232	139071	486	143392	513
114481	232	139072	486	143430	519
		139080	486	143431	519
<b>115000</b>		139081	486	143432	519
115510	214	139082	486	143440	519
115511	214	139090	487	143441	519
115520	214	139091	487	143442	519
115521	214	139092	487	143450	515
115530	214	139100	489	143451	515
115531	214	139101	489	143454	515
115540	215	139102	489	143540	520
115541	215	139120	491	143541	520
115550	215	139121	491	143544	520
115551	215	139122	491	143580	507
		139130	489	143581	507
<b>117000</b>		139131	489	143594	511
117100	265	139132	489	143621	511
117101	265			143731	520
117110	265	<b>143000</b>		143811	521
117111	265	143010	495	143930	512
117311	230	143011	495	143932	512
117321	262	143012	495	143941	516
117331	230	143020	495	143951	517

143960	517	151456	367	155530	312
143961	517	151511	263	155540	447
143990	509	151514	263	155550	266
143991	509	151531	263, 408	155551	266
<b>144000</b>		151534	263, 408	155582	267, 297, 449
144010	511	151591	373	155583	267, 297, 449
144011	511	151710	368	155592	267, 297, 449
144019	511	151711	368	155714	306
144200	515	151740	368	155752	375
144201	515	151741	368	155780	447
144204	515	151781	329	155790	447
		151786	329	155910	313
		151791	329	155930	313
		151796	329		
<b>145000</b>		151800	379	<b>156000</b>	
145990	279, 281, 283, 295, 305, 309	151801	379	156050	268
145994	279, 281, 283, 295, 305, 309	151803	379	156051	268
<b>146000</b>		151810	259	156100	297
146010	453	151811	259	156111	267, 297, 449
146332	389	151830	407	156113	267, 297, 449
146682	387	151831	407	156122	267, 297, 449
146692	387	151840	259, 379, 407	156141	296, 448
		151850	305	156143	296, 448
<b>147000</b>		151851	305	156152	296, 448
147301	405	151853	305		
147306	405	151950	242	<b>158000</b>	
147311	405	151952	242	158400	301
147316	405	151960	242	158410	303
147321	405	151962	242	158799	243
147326	405				
147360	411	<b>152000</b>		<b>161000</b>	
147361	411	152010	407	161271	231
147370	411	152011	407	161291	231
147371	411	152020	407	161461	272
147380	411	152021	407		
147381	411	152101	259	<b>165000</b>	
147441	415	152230	541	165358	319
147442	415	152231	541	165359	319
147443	415	152232	541	165390	317
147444	415	152240	541	165400	317
147529	373	152241	541	165410	317
147550	409	152242	541		
147551	409	152320	538	<b>181000</b>	
147559	409	152321	538	181530	485
		152330	399	181531	485
		152331	399	181532	485
<b>148000</b>		152340	383		
148001	271	152341	383	<b>186000</b>	
148002	271	152360	301	186300	485
148004	270	152370	303	186301	485
148005	271	152380	232	186302	485
148010	357	152381	232	186310	485
148012	361	152430	543	186311	485
148013	361	152431	543	186312	485
148016	361	152600	540	186330	485
148018	356	152601	540	186331	485
148019	359	152610	540	186332	485
148060	360	152611	540	186340	485
148070	233	152640	543	186341	485
148071	233	152641	543	186342	485
148091	359	152750	537	186350	485
148540	388	152751	537	186351	485
		152780	537	186352	485
<b>149000</b>		152781	537	186360	485
149381	305	152960	543	186361	485
149387	305	152961	543	186362	485
149388	305			186640	485
149452	381	<b>153000</b>		186641	485
149471	334	153130	536	186642	485
149511	334	153140	535		
149762	332	153141	535	<b>210000</b>	
149772	332	153420	537	210060	318, 878
		153421	537	210061	878
<b>151000</b>		153560	539	210064	878
151040	314	153561	539		
151041	314	153564	539	<b>220000</b>	
151049	314	153850	537	220000	879
151271	366	153851	537		
151275	366			<b>227000</b>	
151282	337	155156	273	227176	779
151320	362	155180	427	227195	768
151321	362	155236	427	227219	657
151410	367	155373	269	227220	657
151411	367	155490	448	227221	657
151450	367			227410	694
151451	367				

227418	694	229961	812	232195	676, 677
227462	848	229965	812	232285	781
227505	689	229971	813	232294	682
227600	854	229975	813	232295	682
227604	854			232431	755
227680	857	<b>230000</b>		232435	752
227684	857	230030	759	232441	753
227922	667, 668	230034	759	232445	753
		230044	746	232461	752
<b>228000</b>		230045	746	232465	752
228100	667	230060	631, 661, 671, 685	232485	773
228110	667	230061	671	232491	773
228130	667	230063	671	232495	773
228332	849	230066	671	232497	773
228342	849	230069	671	232531	741
228412	839	230084	747	232535	741
228430	845	230085	747	232537	741
228434	845	230090	642	232905	771
228555	699	230355	779	232915	771
228560	699	230365	765		
228712	653, 665, 685	230435	660	<b>233000</b>	
228722	653, 665	230444	746	233094	811
228725	881	230445	746	233095	811
228730	881	230465	659	233104	785
228752	685	230655	747	233105	785
228753	613, 659	230657	747	233114	764
228754	633, 637			233115	764
228771	761	<b>231000</b>		233134	783
228775	761	231010	758	233135	783
228776	761	231012	758	233145	685
228925	665	231015	758	233165	685
228935	665	231035	696	233185	685
228945	665	231072	693	233214	764, 783, 785
228960	663	231205	743	233215	764, 783, 785
228965	663	231215	637	233245	809
		231225	637	233255	809
<b>229000</b>		231230	633, 637, 640, 641	233302	761
229020	646	231231	681	233427	642
229021	646	231233	648, 649, 655, 669, 673	233437	643
229022	646, 647	231235	649	233447	640
229062	827	231305	681	233457	640
229071	815	231315	780	233500	840
229072	815	231351	762	233520	840
229075	815	231355	762	233540	847
229081	815	231370	649	233570	698
229085	815	231371	649	233571	698
229090	697	231410	647	233580	698
229110	825	231411	647	233582	698
229162	668	231420	648	233601	823
229172	668	231440	649	233605	823
229200	847	231455	675	233615	823
229230	846	231457	675	233621	823
229234	847	231475	672	233625	823
229320	843	231505	685	233635	822
229324	843	231515	808	233639	822
229374	843	231525	703	233650	825
229381	839	231535	703	233660	825
229383	839	231541	801	233792	849
229410	641	231545	801		
229411	641	231585	778	<b>234000</b>	
229420	643	231595	672	234505	736
229421	643	231805	768	234515	735
229422	642, 643, 645, 662	231807	768	234525	737
229430	645	231815	675	234535	797
229431	645	231817	675		
229432	645	231960	692	<b>461000</b>	
229524	736	231961	692	461060	868
229525	736			464804	873
229531	735	<b>232000</b>			
229532	735	232045	777	<b>631000</b>	
229535	735	232055	799	631337	433
229551	797	232065	659	631339	433
229554	797	232075	659		
229555	797	232085	659	<b>900000</b>	
229564	737	232101	775	900011	697, 698
229565	737	232105	775		
229574	735	232115	633	<b>955000</b>	
229575	735	232119	633	955135	880
229664	775	232125	633		
229665	775	232135	678	<b>961000</b>	
229702	827	232145	678	961034	879
229740	695	232155	676	961037	878
229741	697	232165	676	961250	878
229931	817	232175	677	961270	878
229935	817	232185	677		

<b>1000100</b>	
1000127	403
1000128	403
1000129	403
1000130	403
1000131	403
1000132	403
1000135	403
1000136	403

<b>1000300</b>	
1000327	377
1000329	377
1000330	377
1000332	801
1000333	767
1000334	767
1000335	781
1000336	779
1000339	801
1000340	767
1000342	767
1000343	673
1000344	673
1000345	673
1000346	673
1000384	849
1000398	659, 661

<b>1000400</b>	
1000422	365
1000423	365
1000458	567
1000459	567
1000461	567
1000462	567
1000464	567
1000465	567
1000466	569, 571
1000468	569, 571
1000469	569, 571
1000473	569
1000474	569
1000476	569
1000477	569
1000479	569
1000480	569
1000487	569
1000489	569
1000497	573
1000498	573

<b>1000500</b>	
1000523	573
1000524	573
1000525	573
1000533	573
1000534	573
1000535	575
1000536	575
1000540	574
1000546	574
1000549	574
1000557	575
1000558	575
1000560	574
1000561	574
1000566	574
1000567	574
1000571	574
1000574	239
1000575	239
1000576	238
1000577	238
1000579	267, 297, 449
1000580	267, 297, 449

<b>1000600</b>	
1000613	351
1000614	353
1000615	353
1000616	351
1000618	351
1000621	353
1000623	353

1000634	367
1000638	362
1000639	362
1000640	362
1000655	849
1000665	662
1000666	662
1000668	341
1000669	341
1000670	341
1000682	666
1000683	666
1000685	253
1000686	253
1000688	253
1000689	253
1000691	253
1000692	253
1000694	253
1000695	253

<b>1000700</b>	
1000702	405
1000703	405
1000704	405
1000711	516
1000712	517
1000713	511
1000714	228
1000715	228
1000716	228
1000717	228
1000718	228
1000719	228
1000720	228
1000721	228
1000726	165
1000729	379
1000730	379
1000735	699
1000736	699
1000763	448
1000773	296
1000777	339
1000780	339
1000783	274
1000784	274
1000785	274
1000786	274
1000797	780
1000799	684

<b>1000800</b>	
1000801	684
1000807	261
1000808	261
1000809	261, 306
1000810	261, 306
1000811	261, 306
1000812	261, 306
1000813	306
1000820	777
1000821	661
1000822	661
1000823	799
1000824	351
1000825	353
1000833	237
1000880	783
1000881	783
1000886	413
1000887	413
1000889	413
1000890	413
1000892	413
1000893	413
1000895	413
1000896	413

<b>1000900</b>	
1000909	880
1000910	377
1000911	377
1000914	218
1000915	218

1000917	218
1000926	293
1000927	293
1000929	293
1000930	293
1000932	293
1000933	293
1000935	293
1000936	293
1000957	297

<b>1001000</b>	
1001015	236
1001016	236
1001017	237
1001018	237
1001019	430
1001020	430

<b>1001100</b>	
1001165	235
1001166	235
1001167	235
1001168	235
1001169	235
1001171	235
1001172	235

<b>1001200</b>	
1001254	853
1001255	853
1001256	853
1001262	853
1001263	853
1001264	237
1001272	380
1001273	380
1001274	380
1001275	380
1001276	380
1001283	431
1001284	431
1001286	431
1001287	431
1001299	341

<b>1001300</b>	
1001300	341
1001303	341
1001304	341
1001309	293
1001310	293
1001314	817
1001359	853

<b>1001400</b>	
1001400	291
1001403	291
1001406	291
1001409	291
1001460	452
1001461	452
1001462	452
1001463	452
1001468	388
1001472	388
1001488	669
1001489	669
1001490	669
1001494	669

<b>1001500</b>	
1001505	275
1001506	275
1001508	275
1001509	275
1001542	279, 281, 283, 295, 305, 307
1001574	861
1001575	861

<b>1001700</b>	
1001701	312
<b>1001800</b>	
1001861	521
1001868	513

1001869	513	1002203	701	1002890	167
1001871	539	1002215	263, 408	1002891	167
1001872	539	1002216	263	1002893	841
<b>1001900</b>		1002218	868	1002895	841
1001901	170	1002221	869	1002897	841
1001902	170	1002228	335	1002898	841
1001903	170	1002229	335	1002899	841
1001905	171	1002238	357		
1001906	171	1002239	371	<b>1002900</b>	
1001907	171	1002240	371	1002900	721
1001930	234	<b>1002400</b>		1002902	721
1001931	234	1002402	745	1002903	807
1001939	272	1002403	745	1002904	807
1001950	153, 157, 161, 165	1002423	875	1002905	783
1001951	153, 157, 161, 165	1002424	875	1002906	631
1001952	153, 157, 161, 165	1002425	875	1002907	631
1001962	697	1002430	387	1002909	188
1001963	697	1002431	387	1002910	188
1001964	694	1002432	387	1002911	188
1001965	694	1002432	387	1002912	188
1001968	509	1002494	663	1002913	189
1001969	762	<b>1002500</b>		1002914	189
1001970	762	1002503	763	1002915	193
1001999	655	1002504	763	1002917	193
		1002505	763	1002918	193
<b>1002000</b>		1002583	453, 601	1002919	193
1002000	655	1002591	221	1002922	243
1002001	655	1002592	221	1002925	373
1002002	777	1002594	221	1002927	373
1002003	257	<b>1002600</b>		1002928	363
1002004	255	1002602	482	1002929	363
1002005	255	1002603	482	1002931	379
1002006	255	1002604	482	1002933	379
1002008	257	1002607	387	1002934	261
1002010	255	1002608	387	1002936	261
1002011	255	1002686	535	1002937	305
1002012	255	1002690	491	1002939	305
1002013	255	1002691	868	1002940	426
1002015	255	1002692	868	1002941	426
1002018	765	1002693	868	1002948	311
1002020	423	1002694	491	1002949	311
1002021	423	1002695	491	1002950	311
1002022	423	1002696	491	1002951	310
1002023	405	1002697	485	1002952	760
1002024	405	1002698	485	1002953	760
1002025	405	1002699	485	1002954	760
1002029	411	<b>1002700</b>		1002955	760
1002030	411	1002700	485	1002956	679
1002032	739	1002701	485	1002957	679
1002033	739	1002702	485	1002958	679
1002034	739	1002703	485	1002959	679
1002035	773	1002704	485	1002962	329
1002045	315	1002705	485	1002964	329
1002046	315	1002791	872	1002965	261
1002069	759	<b>1002800</b>		1002967	272
1002070	759	1002842	363	1002968	272
1002075	425	1002843	363	1002969	401
1002076	425	1002844	363	1002970	401
1002077	425	1002845	497	1002971	401
1002098	244	1002853	723, 725, 727, 729, 730, 777	1002973	401
1002099	244	1002854	520	1002974	401
<b>1002100</b>		1002855	381	1002975	401
1002100	244	1002860	389	1002976	401
1002101	244	1002861	489	1002977	401
1002102	244	1002862	489	1002978	401
1002110	517	1002863	489	1002979	241
1002111	517	1002864	490	1002980	241
1002113	517	1002865	490	1002981	241
1002116	387	1002866	490	1002982	243
1002117	387	1002867	785	1002989	770
1002118	387	1002868	769	1002990	770
1002119	387	1002869	769	1002991	681
1002140	383	1002871	652	1002992	681
1002151	495	1002873	509	<b>1003000</b>	
1002152	495	1002874	509	1003001	683
1002153	495	1002875	509	1003004	281
1002163	279, 281, 283, 295	1002876	535	1003005	281
1002190	333	1002877	535	1003006	281
1002191	333	1002878	535	1003007	281
1002192	333	1002882	165	1003008	223
<b>1002200</b>		1002884	785	1003009	223
1002201	701			1003010	223
				1003011	225
				1003012	225

1003013	225	1003508	339	1004737	591
1003014	419	1003518	811	1004738	376
1003015	419	1003519	811	1004739	376
1003016	419	1003530	290	1004740	370
1003017	417	1003532	290	1004741	370
1003018	417	1003535	651	1004742	370
1003019	417	1003536	650	1004743	370
1003029	448	1003537	651	1004744	281, 295, 309, 318
1003040	275	1003538	651	1004745	281, 295, 309
1003041	275	1003539	775	1004746	281, 295, 309
1003042	275			1004747	749
1003043	275	<b>1004600</b>		1004748	749
1003044	289	1004649	785	1004749	629
1003045	289	1004650	756	1004750	629
1003046	289	1004651	756	1004751	629
1003047	289	1004652	701	1004757	693
1003048	289	1004653	808	1004759	188
1003049	289	1004660	349	1004760	188
1003050	289	1004661	349	1004761	188
1003051	289	1004662	349	1004762	188
1003052	275	1004663	349	1004763	188
1003053	275	1004664	399	1004764	188
1003054	275	1004665	399	1004765	189
1003055	275	1004666	258	1004766	189
1003073	243	1004667	258	1004767	189
1003074	243	1004668	229	1004768	189
		1004669	229	1004769	194
<b>1003100</b>		1004670	355	1004770	194
1003104	870	1004671	355	1004771	194
1003105	871	1004674	295, 309	1004772	194
1003106	869	1004675	295, 309	1004773	296, 448
		1004676	295	1004774	267, 297, 449
<b>1003300</b>		1004677	797	1004775	267, 297, 449
1003316	369	1004678	757	1004780	875
1003317	369	1004679	757	1004781	876
		1004680	653	1004782	877
<b>1003400</b>		1004681	653	1004783	497
1003416	729	1004682	376	1004784	497
1003417	729	1004686	533	1004785	497
1003418	730	1004687	533		
1003419	730	1004688	533	<b>1004800</b>	
1003420	795	1004689	533	1004889	570
1003421	795	1004690	533	1004890	570
1003422	725	1004691	533	1004893	571
1003423	725	1004692	533	1004894	571
1003424	727	1004693	533	1004895	571
1003425	727	1004694	223	1004896	577
1003426	793	1004695	223	1004897	577
1003427	793	1004696	223	1004898	577
1003428	375	1004697	225	1004899	577
1003429	375	1004698	225		
1003430	375	1004699	225	<b>1004900</b>	
1003431	375			1004900	578
1003432	307	<b>1004700</b>		1004901	578
1003435	300	1004700	419	1004902	578
1003436	300	1004701	419	1004903	579
1003437	729	1004702	419	1004904	579
1003438	730	1004705	417	1004905	577
1003439	795	1004706	382	1004906	577
1003440	725	1004707	382	1004907	577
1003441	727	1004708	582	1004908	577
1003442	793	1004709	582	1004909	578
1003447	692	1004710	582	1004910	578
1003448	692	1004712	583	1004911	579
1003449	813	1004713	583	1004912	578
1003450	813	1004714	583	1004913	578
1003451	813	1004716	584	1004914	578
1003452	813	1004717	584	1004915	578
1003453	759	1004718	584	1004916	578
1003454	759	1004719	584	1004917	578
1003455	384	1004720	585	1004932	575
1003456	385	1004721	585	1004933	507
1003457	384	1004722	586	1004934	507
1003458	385	1004723	586	1004935	507
1003459	385	1004725	587	1004936	507
1003460	385	1004726	591	1004957	785
1003466	240	1004727	589	1004969	349
1003467	364	1004729	330	1004970	453
1003468	364	1004730	330	1004971	337
1003470	721	1004731	331		
1003479	792, 793, 795	1004732	359	<b>1005000</b>	
		1004733	356	1005075	862
<b>1003500</b>		1004734	591	1005076	862
1003506	339	1004735	591	1005077	862
1003507	339	1004736	591	1005078	862



1005079	862	1005315	862	1006195	874
1005080	862	1005316	862	1006196	874
1005081	862	1005317	864	1006197	874
1005082	862	1005318	864	1006198	875
1005083	862	1005381	869	1006199	874
1005085	420	1005387	873		
1005086	420	1005390	445	<b>1006200</b>	
1005087	421	1005391	445	1006202	873
1005088	421	1005392	445	1006268	719
1005089	814	1005394	445	1006270	719
1005090	814	1005395	288		
		1005396	288	<b>1006300</b>	
<b>1005100</b>		1005397	532	1006307	355
1005125	755	1005399	532	1006308	355
1005126	755			1006314	749
1005148	739	<b>1005400</b>		1006316	791
1005149	739	1005400	532	1006317	720
1005150	739	1005401	532	1006318	720
1005151	741	1005402	532	1006319	349, 720
1005153	741	1005407	217	1006321	861
1005154	741	1005408	217	1006326	691
1005155	741	1005410	217	1006327	792
1005156	741	1005415	217	1006328	723
1005157	741	1005416	217	1006329	723
1005177	188	1005418	217	1006336	870
1005178	189	1005423	217	1006343	445
		1005424	217	1006344	445
<b>1005200</b>		1005435	220	1006345	288
1005201	744	1005436	220	1006348	869
1005202	811	1005439	630	1006377	295
1005205	725, 727, 729, 730, 731, 793	1005440	630	1006378	295
1005206	725, 727, 729, 730, 731, 793	1005441	683	1006379	614, 615, 616, 617, 618, 619
1005207	725, 727, 729, 730, 731, 793	1005442	639	1006380	614, 615, 616, 617, 618, 619
1005214	318	1005443	751	1006381	614, 615, 616, 617, 618, 619
1005215	318	1005444	869	1006382	614, 615, 616, 617, 618, 619
1005216	318	1005445	869	1006383	616
1005217	318	1005446	171, 873	1006384	619
1005218	318			1006385	618
1005248	876	<b>1006100</b>		1006386	621
1005262	725, 727, 729, 730, 731	1006104	855	1006387	617
1005263	725, 727, 729, 730, 731	1006105	855	1006388	620
1005265	865	1006106	839	1006389	617
1005268	865	1006107	839	1006390	619
1005269	860	1006120	877	1006391	618
1005271	860	1006121	219	1006392	621
1005272	860	1006122	219	1006393	617
1005273	861	1006123	429	1006394	620
1005274	863	1006124	429	1006395	281
1005275	863	1006125	429	1006396	281
1005276	863	1006126	429	1006397	281
1005277	863	1006127	429	1006398	281
1005278	863	1006128	429	1006399	281
1005279	863	1006133	871		
1005280	863	1006134	872	<b>1006400</b>	
1005281	863	1006155	508	1006400	281
1005282	863	1006156	508	1006402	281
1005283	863	1006157	534	1006403	281
1005284	860	1006158	534	1006404	717
1005285	860	1006159	309, 508, 534	1006405	717
1005286	860	1006160	309, 508, 534	1006406	821
1005287	860	1006161	382	1006407	821
1005288	860	1006162	382	1006408	627
1005289	865	1006171	851	1006409	627
1005290	865	1006172	851	1006410	318
1005291	863	1006173	851	1006411	157
1005292	863	1006174	851	1006412	157
1005294	864	1006175	851	1006414	157
1005295	864	1006176	851	1006415	157
1005296	864	1006178	742	1006417	157
1005297	862	1006179	742	1006418	157
1005298	862	1006180	635	1006420	157
1005299	862	1006181	635	1006421	157
		1006182	635	1006423	395
<b>1005300</b>		1006183	743	1006424	395
1005301	864	1006184	637	1006425	397
1005302	864	1006185	191	1006426	397
1005303	864	1006186	191	1006427	397
1005305	865	1006187	191	1006428	397
1005307	865	1006188	191	1006429	397
1005308	865	1006189	191	1006430	397
1005310	865	1006190	191	1006431	285
1005311	861	1006191	691	1006432	285
1005312	861	1006192	691	1006433	285
1005313	863	1006193	691	1006434	285
1005314	863	1006194	874	1006435	285

1006436	285	1006633	475	1007250	870
1006437	285	1006634	475	1007251	870
1006438	285	1006635	475	1007252	870
1006439	397	1006636	475	1007253	870
1006440	397	1006639	477	1007254	871
1006441	347	1006640	477	1007255	871
1006442	347	1006641	477	1007256	871
1006443	347	1006642	477	1007257	871
1006444	347	1006645	477	1007270	876
1006445	505	1006646	477	1007271	208
1006446	505	1006647	477	1007272	208
1006449	285, 347, 395, 505	1006648	477	1007273	209
1006450	285, 347, 395, 505			1007274	209
1006451	285, 347, 395, 505	<b>1007000</b>		1007281	711
1006452	868	1007083	459, 463, 467	1007282	711
1006453	881	1007084	459, 463, 467	1007283	880
1006454	243, 874	1007090	207	1007284	150
1006455	875	1007091	207	1007285	150
1006456	873	1007092	207	1007286	152
		1007093	207	1007287	152
<b>1006500</b>		1007094	207	1007288	150
1006565	459, 463, 467	1007095	205	1007289	150
1006566	459, 463, 467	1007096	205	1007290	152
1006567	459, 463, 467	1007097	205	1007291	152
1006568	459, 463, 467	1007098	205	1007292	150
1006569	459, 463, 467	1007099	205	1007293	150
1006570	459, 463, 467			1007294	152
1006571	459, 463, 467	<b>1007100</b>		1007295	152
1006572	459, 463, 467	1007137	459, 463, 467	1007296	150
1006573	459, 463, 467	1007138	459, 463, 467	1007297	150
1006574	459, 463, 467	1007142	715	1007298	152
1006575	459	1007143	715	1007299	152
1006576	459	1007144	715		
1006577	459	1007145	715	<b>1007300</b>	
1006578	459	1007146	689	1007300	151
1006579	459	1007147	689	1007301	151
1006580	459	1007180	205	1007302	153
1006581	463	1007181	205	1007303	153
1006582	463	1007182	205	1007304	151
1006583	463	1007183	205	1007305	151
1006584	463	1007184	207	1007306	153
1006585	463	1007185	207	1007307	153
1006586	463	1007186	207	1007308	151
1006587	467	1007187	207	1007309	151
1006588	467	1007188	463, 467	1007310	153
1006589	467	1007189	463, 467	1007311	153
1006590	467	1007190	285, 347, 395, 505	1007312	151
1006591	467	1007191	207	1007313	151
1006592	467	1007192	205	1007314	153
1006593	459	1007193	205	1007315	153
1006594	459	1007194	207	1007316	161
1006595	463	1007195	831	1007317	161
1006596	463	1007196	831	1007318	161
1006597	467	1007197	831	1007319	161
1006598	467	1007198	831	1007320	161
1006599	459, 463, 467			1007321	161
		<b>1007200</b>		1007322	161
<b>1006600</b>		1007200	331	1007323	161
1006600	459, 463, 467	1007201	331	1007324	161
1006601	459, 463, 467	1007202	331	1007325	161
1006602	459, 463, 467	1007207	744	1007326	161
1006603	459, 463, 467	1007213	872	1007327	161
1006604	459, 463, 467	1007215	872	1007328	126
1006605	459, 463, 467	1007216	876	1007329	126
1006606	459, 463, 467	1007225	876	1007330	126
1006607	459, 463, 467	1007226	872	1007331	126
1006608	459, 463, 467	1007228	872	1007332	126
1006609	459, 463	1007229	873	1007333	126
1006610	467	1007230	861	1007334	126
1006611	459	1007231	861	1007335	126
1006612	459	1007232	614	1007336	126
1006613	459, 463, 467	1007233	614	1007337	126
1006614	459, 463, 467	1007234	615	1007338	126
1006615	473	1007235	615	1007339	126
1006616	473	1007236	714	1007340	126
1006617	473	1007237	613	1007341	126
1006618	473	1007238	835, 837	1007342	126
1006621	475	1007239	835, 837	1007343	126
1006622	475	1007240	835, 837	1007344	126
1006623	475	1007241	837	1007345	126
1006624	475	1007242	837	1007346	126
1006627	473	1007243	835	1007347	126
1006628	473	1007244	835	1007348	126
1006629	473	1007245	835	1007349	126
1006630	473	1007246	837	1007350	126

1007351	126	1007443	126	1007597	279, 505, 531
1007352	503	1007444	126	1007598	279
1007353	503	1007445	126	1007599	279
1007354	503	1007446	126		
1007355	529	1007447	126	<b>1007600</b>	
1007356	529	1007448	126	1007600	327
1007357	437, 597	1007449	126	1007601	327
1007358	437, 597	1007450	126	1007602	327
1007359	437, 597	1007451	126	1007603	327
1007360	437, 597	1007452	126	1007604	251
1007361	437, 597	1007453	126	1007605	251
1007362	437, 597	1007454	126	1007606	251
1007363	443	1007458	805	1007607	251
1007364	443	1007459	607	1007608	395
1007365	443	1007460	607	1007609	395
1007366	443	1007461	791	1007610	395
1007368	138	1007462	444	1007611	395
1007369	138	1007463	444	1007612	325
1007370	138	1007464	444	1007613	325
1007371	138	1007465	444	1007614	325
1007372	138	1007466	444	1007615	325
1007373	138	1007467	444	1007616	325
1007374	138	1007468	287	1007617	325
1007375	138	1007469	287	1007618	325
1007376	138	1007470	287	1007619	325
1007377	138	1007471	287	1007620	443
1007378	138	1007472	287	1007621	443
1007379	138	1007473	287	1007622	443
1007380	441, 601	1007488	126	1007623	443
1007381	124	1007489	126	1007624	139
1007382	124			1007625	139
1007383	124	<b>1007500</b>		1007626	139
1007384	124	1007511	805	1007627	139
1007385	134	1007512	609	1007628	139
1007386	134	1007513	609	1007629	139
1007387	134	1007521	178	1007630	126
1007388	134	1007522	178	1007631	126
1007389	134	1007523	178	1007632	126
1007390	134	1007524	178	1007633	126
1007391	134	1007525	178	1007634	126
1007392	134	1007526	178	1007635	126
1007393	134	1007527	178	1007636	126
1007394	134	1007528	178	1007637	126
1007395	134	1007529	178	1007638	501
1007396	134	1007530	178	1007639	501
1007397	134	1007531	178	1007640	501
1007398	134	1007532	178	1007641	503
1007399	134	1007533	178	1007642	503
		1007534	178	1007643	503
<b>1007400</b>		1007535	178	1007644	527
1007400	134	1007536	178	1007645	527
1007401	137	1007537	178	1007646	527
1007402	137	1007538	178	1007647	527
1007403	137	1007539	178	1007648	529
1007404	137	1007540	178	1007649	529
1007405	135	1007541	178	1007651	603
1007406	135	1007542	178	1007652	603
1007407	135	1007543	178	1007653	805
1007408	135	1007544	178	1007654	525
1007409	125	1007545	178	1007655	525
1007410	125	1007546	178	1007656	525
1007411	125	1007547	178	1007657	525
1007412	125	1007551	213	1007667	713
1007421	124	1007552	213	1007668	713
1007422	124	1007559	213	1007669	611
1007423	135	1007560	213	1007670	611
1007424	135	1007567	213	1007673	501
1007425	135	1007568	213	1007674	501
1007426	135	1007580	605	1007680	833
1007427	135	1007581	709	1007681	833
1007428	135	1007582	789	1007682	833
1007429	135	1007583	605	1007683	833
1007430	135	1007584	605	1007684	833
1007431	125	1007585	709	1007685	833
1007432	125	1007586	789	1007692	439, 599
1007433	136	1007587	605	1007693	439, 599
1007434	136	1007588	279	1007694	439, 599
1007435	136	1007589	279	1007695	439, 599
1007436	136	1007590	393	1007696	439, 599
1007437	136	1007591	393	1007697	439, 599
1007438	136	1007592	393		
1007439	137	1007593	393		
1007440	137	1007594	345		
1007441	137	1007595	345		
1007442	137	1007596	279, 505, 531		

SIGHT MOVE  
1004690



**MONOFÁSICA**

CALHA ELETRIFICADA SALIENTE  
 MONOFÁSICA \_\_\_\_\_ 495  
 ACESSÓRIOS PARA CALHA ELETRIFICADA  
 SALIENTE MONOFÁSICA \_\_\_\_\_ 497  
 CALHA ELETRIFICADA DE MONTAGEM  
 ENCASTRADA MONOFÁSICA \_\_\_\_\_ 499  
 ACESSÓRIOS PARA CALHA ELETRIFICADA DE  
 MONTAGEM ENCASTRADA MONOFÁSICA \_\_\_\_\_ 499

**TRIFÁSICA**

EUTRAC® CALHA ELETRIFICADA SALIENTE  
 TRIFÁSICA \_\_\_\_\_ 537  
 EUTRAC® ACESSÓRIOS PARA CALHA  
 ELETRIFICADA SALIENTE TRIFÁSICA \_\_\_\_\_ 539  
 EUTRAC® CALHA ELETRIFICADA DE  
 MONTAGEM ENCASTRADA TRIFÁSICA \_\_\_\_\_ 541  
 EUTRAC® ACESSÓRIOS PARA CALHA  
 ELETRIFICADA TRIFÁSICA DE MONTAGEM  
 SALIENTE \_\_\_\_\_ 541  
 CALHA ELETRIFICADA SALIENTE TRIFÁSICA  
 S-TRACK DALI \_\_\_\_\_ 529  
 ACESSÓRIOS PARA CALHA ELETRIFICADA  
 SALIENTE TRIFÁSICA S-TRACK DALI \_\_\_\_\_ 530-531  
 CALHA ELETRIFICADA DE MONTAGEM  
 ENCASTRADA TRIFÁSICA S-TRACK DALI \_\_\_\_\_ 533  
 ACESSÓRIOS PARA CALHA ELETRIFICADA  
 DE MONTAGEM ENCASTRADA TRIFÁSICA  
 S-TRACK DALI \_\_\_\_\_ 535

**SISTEMAS DE 48V**

CALHA ELETRIFICADA SALIENTE TRACK  
 DALI DE 48V \_\_\_\_\_ 457  
 ACESSÓRIOS PARA CALHA ELETRIFICADA  
 SALIENTE TRACK DALI DE 48V \_\_\_\_\_ 459  
 CALHA ELETRIFICADA SALIENTE PROFUNDA  
 TRACK DALI DE 48V \_\_\_\_\_ 461  
 ACESSÓRIOS PARA CALHA ELETRIFICADA  
 SALIENTE PROFUNDA TRACK DALI DE 48V \_\_\_\_\_ 463  
 CALHA ELETRIFICADA DE MONTAGEM  
 ENCASTRADA TRACK DALI DE 48V \_\_\_\_\_ 465  
 ACESSÓRIOS PARA CALHA ELETRIFICADA  
 DE MONTAGEM ENCASTRADA TRACK DALI  
 DE 48V \_\_\_\_\_ 467

**A**

ABRIDOR 100 POLE \_\_\_\_\_ 681  
 ABRIDOR 60 POLE \_\_\_\_\_ 681  
 ABRIDOR SENSOR WL \_\_\_\_\_ 770  
 ABRIDOR WL \_\_\_\_\_ 770

**ACESSÓRIOS**

BATENTE PARA CABO DE AÇO \_\_\_\_\_ 879  
 BRAÇADEIRA DE CABOS \_\_\_\_\_ 878  
 CABO EM TECIDO, 3 PINOS, 10 M \_\_\_\_\_ 878  
 CAIXA DE DERIVAÇÃO EM T IP68,  
 3 PINOS \_\_\_\_\_ 881  
 CAIXA DE LIGAÇÃO IP68, 3 POLOS \_\_\_\_\_ 881  
 CAIXA DE LIGAÇÃO IP68, 5 POLOS \_\_\_\_\_ 881  
 CASQUILHO GU10 \_\_\_\_\_ 880  
 CONNECTION BOX IP68, 5 PINOS, DALI \_\_\_\_\_ 881  
 CONTROLADOR LED 10W | 200MA |  
 REGULÁVEL INCL. ALÍVIO DE TENSÃO \_\_\_\_\_ 872  
 CONTROLADOR LED 100W | 24V DC DALI  
 REGULÁVEL INCL. ALÍVIO DE TENSÃO \_\_\_\_\_ 871  
 CONTROLADOR LED 100W | 24V DC  
 INCL. ALÍVIO DE TENSÃO \_\_\_\_\_ 870  
 CONTROLADOR LED 10W | 250MA \_\_\_\_\_ 875  
 CONTROLADOR LED 12W | 250MA DALI  
 REGULÁVEL COM INTERFACE RF \_\_\_\_\_ 874  
 CONTROLADOR LED 150W | 24V DC DALI  
 REGULÁVEL INCL. ALÍVIO DE TENSÃO \_\_\_\_\_ 871  
 CONTROLADOR LED 150W | 24V DC  
 INCL. ALÍVIO DE TENSÃO \_\_\_\_\_ 870  
 CONTROLADOR LED 20W |  
 250-700MA 1-10V/DALI REGULÁVEL \_\_\_\_\_ 875  
 CONTROLADOR LED 20W | 700MA |  
 REGULÁVEL \_\_\_\_\_ 873  
 CONTROLADOR LED 20W | 350MA |  
 DIMMBAR \_\_\_\_\_ 872  
 CONTROLADOR LED 20W | 350MA \_\_\_\_\_ 876  
 CONTROLADOR LED 20W | 350MA/500MA |  
 PHASE \_\_\_\_\_ 872  
 CONTROLADOR LED 21W | 500MA  
 INCL. ALÍVIO DE TENSÃO \_\_\_\_\_ 876

CONTROLADOR LED 25W | 150-300MA |  
 DALI REGULÁVEL \_\_\_\_\_ 873  
 CONTROLADOR LED 25W | 150-700MA |  
 DALI REGULÁVEL \_\_\_\_\_ 873  
 CONTROLADOR LED 250W | 24V DC DALI  
 REGULÁVEL INCL. ALÍVIO DE TENSÃO \_\_\_\_\_ 871  
 CONTROLADOR LED 250W | 24V DC  
 INCL. ALÍVIO DE TENSÃO \_\_\_\_\_ 870  
 CONTROLADOR LED 3W | 350MA  
 INCL. CONECTOR AMP \_\_\_\_\_ 876  
 CONTROLADOR LED 3W | 700MA  
 INCL. ALÍVIO DE TENSÃO \_\_\_\_\_ 876  
 CONTROLADOR LED 30W | 24V DC DALI  
 REGULÁVEL INCL. ALÍVIO DE TENSÃO \_\_\_\_\_ 871  
 CONTROLADOR LED 30W | 24V DC  
 INCL. ALÍVIO DE TENSÃO \_\_\_\_\_ 870  
 CONTROLADOR LED 30W | 700MA \_\_\_\_\_ 876  
 CONTROLADOR LED 3W | 350MA \_\_\_\_\_ 876  
 CONTROLADOR LED 40W | 1000MA |  
 REGULÁVEL \_\_\_\_\_ 873  
 CONTROLADOR LED 40W | 1050MA |  
 REGULÁVEL \_\_\_\_\_ 873  
 CONTROLADOR LED 40W | 500MA DALI  
 REGULÁVEL COM INTERFACE RF \_\_\_\_\_ 874  
 CONTROLADOR LED 40W |  
 500-1050MA 1-10V/DALI REGULÁVEL \_\_\_\_\_ 875  
 CONTROLADOR LED 40W | 700MA |  
 REGULÁVEL \_\_\_\_\_ 873  
 CONTROLADOR LED 40W | 700MA DALI  
 REGULÁVEL COM INTERFACE RF \_\_\_\_\_ 874  
 CONTROLADOR LED 40W | 1050MA \_\_\_\_\_ 877  
 CONTROLADOR LED 40W | 1050MA DALI  
 CCT TUNABLE \_\_\_\_\_ 875  
 CONTROLADOR LED 40W | 700/900/1000MA  
 CONTROLADOR LED 50W |  
 700-1500MA 1-10V/DALI REGULÁVEL \_\_\_\_\_ 875  
 CONTROLADOR LED 6W | 350MA |  
 REGULÁVEL \_\_\_\_\_ 872  
 CONTROLADOR LED 700MA | PHASE \_\_\_\_\_ 872  
 CONTROLADOR LED, 40W | 1050MA DALI  
 REGULÁVEL COM INTERFACE RF \_\_\_\_\_ 874  
 CONTROLLER LED STIP CCT / RGBW \_\_\_\_\_ 869  
 CONVERSOR PHASE DIM -> DALI \_\_\_\_\_ 868  
 DALI CONTROLLER 24V DC \_\_\_\_\_ 869  
 DALI INTERFACE 1-10V + ON/OFF \_\_\_\_\_ 868  
 DALI UNIVERSAL DIMMER 10-300W \_\_\_\_\_ 869  
 EXTENSÃO DE CABO \_\_\_\_\_ 879  
 FITA ADESIVA DE DUPLA FACE \_\_\_\_\_ 879  
 FONTE DE ALIMENTAÇÃO LED 100W | 24V |  
 2 CANAIS DALI REGULÁVEL \_\_\_\_\_ 872  
 FONTE DE ALIMENTAÇÃO LED 100W |  
 24V DC \_\_\_\_\_ 871  
 FONTE DE ALIMENTAÇÃO LED 15W | 12V \_\_\_\_\_ 869  
 FONTE DE ALIMENTAÇÃO LED 15W | 24V \_\_\_\_\_ 869  
 FONTE DE ALIMENTAÇÃO LED 20W | 12/24V \_\_\_\_\_ 869  
 FONTE DE ALIMENTAÇÃO LED 25W | 24V \_\_\_\_\_ 870  
 FONTE DE ALIMENTAÇÃO LED 50W | 24V \_\_\_\_\_ 870  
 FONTE DE ALIMENTAÇÃO LED 60 W | DALI,  
 24V, 2 CANAIS DALI REGULÁVEL \_\_\_\_\_ 871  
 GANCHO PARA TETO \_\_\_\_\_ 878  
 GLENOS® ROSETA PARA TETO \_\_\_\_\_ 878  
 GU10 CONNECTION BOX COM BASE,  
 UNIVERSAL \_\_\_\_\_ 880  
 GU10 LED CONNECTION BOX COM BASE,  
 MÁX. 10W \_\_\_\_\_ 880  
 MÓDULO DE RF PARA CONTROLADOR  
 DALI \_\_\_\_\_ 874, 875  
 REBORDO DA FICHA ELÉTRICA DE  
 3 TOMADAS \_\_\_\_\_ 879  
 SUSPENSÃO DE CABOS DE AÇO \_\_\_\_\_ 878  
 TRANSFORMADOR 60VA | 12V AC \_\_\_\_\_ 868  
 TRANSFORMADOR TENSEO 12V CA |  
 105VA CONVENCIONAL \_\_\_\_\_ 868  
 TRANSFORMADOR TENSEO 12V CA |  
 210VA CONVENCIONAL \_\_\_\_\_ 868  
 TRANSFORMADOR TENSEO 12V CA |  
 50VA CONVENCIONAL \_\_\_\_\_ 868  
 ADEGAN FL, E27 \_\_\_\_\_ 663  
 ADEGAN MANILA FL, E27 \_\_\_\_\_ 663  
 ADI EL \_\_\_\_\_ 822  
 AINOS CW \_\_\_\_\_ 812  
 AINOS CW SENSOR \_\_\_\_\_ 813  
 AINOS CW SENSOR, QUADRADO \_\_\_\_\_ 813  
 AINOS CW, QUADRADO \_\_\_\_\_ 813

AKALO D83 EL \_\_\_\_\_ 237  
 ALPA CONE 100 POLE, E27 \_\_\_\_\_ 665  
 ALPA MUSHROOM 45 POLE, E27 \_\_\_\_\_ 665  
 ALPA MUSHROOM 75 POLE, E27 \_\_\_\_\_ 665  
 ALTRA DICE CL, QPAR51 \_\_\_\_\_ 263  
 ALTRA DICE CW, DOUBLE, QPAR51 \_\_\_\_\_ 263, 408  
 ALTRA DICE TRACK MONOF., QPAR51 \_\_\_\_\_ 521  
 ALTRA DICE TRACK TRIF., QPAR51 \_\_\_\_\_ 556  
 ANDREAS WL, QT-DE12 \_\_\_\_\_ 373  
 ANELA CL, PHASE \_\_\_\_\_ 261  
 ANELA PD, PHASE \_\_\_\_\_ 306  
 ANGOLUX SENSOR WL \_\_\_\_\_ 762  
 ANGOLUX WL \_\_\_\_\_ 762  
 APONI 120 POLE, PHASE \_\_\_\_\_ 666  
 APONI 90 POLE, PHASE \_\_\_\_\_ 666  
 ARLINA 130 WL \_\_\_\_\_ 371  
 ARLINA 60 WL \_\_\_\_\_ 371  
 ARROCK ARC POLE, QPAR51 \_\_\_\_\_ 648  
 ARROCK GRANITE 40 POLE, SQUARE, E27 \_\_\_\_\_ 647  
 ARROCK GRANITE 70 POLE, SQUARE, E27 \_\_\_\_\_ 647  
 ARROCK SLOT POLE, QPAR51 \_\_\_\_\_ 649  
 ARROCK STONE 50 POLE \_\_\_\_\_ 649  
 ARROCK STONE 75 POLE \_\_\_\_\_ 649  
 ASMARALV, QR-C51 \_\_\_\_\_ 486  
 ASSO 300 WL, PHASE \_\_\_\_\_ 366, 367  
 ASTINA CL, QPAR51 \_\_\_\_\_ 261  
 ASTINA PD, QPAR51 \_\_\_\_\_ 305  
 ASTINA STEEL WL, QPAR51 \_\_\_\_\_ 761  
 ASTINA UP/DOWN WL, QPAR51 \_\_\_\_\_ 379  
 ASTINA WL, QPAR51 \_\_\_\_\_ 761  
 ASTO CW, DOUBLE, QPAR51 \_\_\_\_\_ 415  
 ASTO CW, QUAD, QPAR51 \_\_\_\_\_ 415  
 ASTO CW, SINGLE, QPAR51 \_\_\_\_\_ 415  
 ASTO CW, TRIPLE, QPAR51 \_\_\_\_\_ 415  
 ASTO TUBE MONOF., GU10 \_\_\_\_\_ 505  
 ASTO TUBE CL, SINGLE, GU10 \_\_\_\_\_ 395  
 ASTO TUBE CW, DOUBLE, GU10 \_\_\_\_\_ 397  
 ASTO TUBE CW, QUADRUPLE, GU10 \_\_\_\_\_ 397  
 ASTO TUBE CW, SINGLE, GU10 \_\_\_\_\_ 397  
 ASTO TUBE CW, TRIPLE, GU10 \_\_\_\_\_ 397  
 ASTO TUBE REFLECTOR  
 DECORATIVO \_\_\_\_\_ 285, 395, 505  
 ASTO TUBE PD, DOUBLE, GU 10 \_\_\_\_\_ 285  
 ASTO TUBE PD, QUADRUPLE, GU 10 \_\_\_\_\_ 285  
 ASTO TUBE PD, SINGLE, GU 10 \_\_\_\_\_ 285  
 ASTO TUBE PD, TRIPLE, GU 10 \_\_\_\_\_ 285  
 ASTO TUBE WL, SINGLE, GU10 \_\_\_\_\_ 347  
 ASTO TUBE WL, UP/DOWN, GU10 \_\_\_\_\_ 347  
 AVO CW, DOUBLE, QPAR51 \_\_\_\_\_ 413  
 AVO CW, QUAD, QPAR51 \_\_\_\_\_ 413  
 AVO CW, SINGLE, QPAR51 \_\_\_\_\_ 413  
 AVO CW, TRIPLE, QPAR51 \_\_\_\_\_ 413  
 AVO TRACK MONOF., QPAR51 \_\_\_\_\_ 515  
 AVO TRACK TRIF., QPAR51 \_\_\_\_\_ 561

**B**

BASKET WL, E27 \_\_\_\_\_ 373  
 BATTEN 120 CW \_\_\_\_\_ 429  
 BATTEN 60 CW \_\_\_\_\_ 429  
 BENA 120 CW \_\_\_\_\_ 433  
 BENA 150 CW \_\_\_\_\_ 433  
 BIG NAILS 50 POLE, E27 \_\_\_\_\_ 668  
 BIG NAILS 80 POLE, E27 \_\_\_\_\_ 668  
 BIG NAUTILUS SP, REDONDO, QPAR51 \_\_\_\_\_ 694  
 BIG PLOT COBERTURA, 2 PEÇAS \_\_\_\_\_ 853  
 BIG PLOT COBERTURA, 4 PEÇAS \_\_\_\_\_ 853  
 BIG PLOT MÓDULOS \_\_\_\_\_ 853  
 BIG QUAD UP/DOWN WL \_\_\_\_\_ 755  
 BIG QUAD WL \_\_\_\_\_ 752, 755  
 BIG THEO CL \_\_\_\_\_ 797  
 BIG THEO CL, QPAR111 \_\_\_\_\_ 797  
 BIG THEO UP/DOWN WL, QPAR111 \_\_\_\_\_ 735  
 BIG THEO WL \_\_\_\_\_ 737  
 BIG THEO WL, QPAR111 \_\_\_\_\_ 737  
 BIMA MONOF., DOUBLE, QPAR51 \_\_\_\_\_ 519  
 BIMA MONOF., SINGLE, QPAR51 \_\_\_\_\_ 519  
 BIMA TRIF., DOUBLE, QPAR51 \_\_\_\_\_ 559  
 BIMA TRIF., SINGLE, QPAR51 \_\_\_\_\_ 559  
 BOOKAT POLE \_\_\_\_\_ 683  
 BOOKAT WL \_\_\_\_\_ 751  
 BOX UP/DOWN WL, QT-DE12 \_\_\_\_\_ 773  
 BOX-L WL \_\_\_\_\_ 773  
 BOX-L WL, E27 \_\_\_\_\_ 773  
 BRICK DOWNUNDER EL \_\_\_\_\_ 827  
 BRICK DOWNUNDER EL, E14 \_\_\_\_\_ 827

BRICK EL, ASSIMÉTRICO	825
BRICK EL, SIMÉTRICO	825
BRICK MESH EL	825
BULAN CW, E14	815
BULAN GRID CW, E27	815

<b>C</b>	
C-POL POLE, E27	672
CARISO WL, PHASE	368
CHROMBO WL, PHASE	369
COMET LED LV	491
COMET LV, QR-C51	491
CONCRETO EL, CUT	821
CONCRETO EL, WING	821
CONCRETO FL, QUADRADO, QPAR51	627
CONCRETO FL, REDONDO, QPAR 51	627
CONCRETO L WL	717
CONCRETO M WL	717
CONE FL, E27	660
COSMIC LV, QR-C51	487
COUPA FLEX WL	381
CUBIX FL, QPAR51	660
CYFT CW	395

<b>D</b>	
DASAR® 115 RL, QUADRADO, QPAR51	843
DASAR® 115 RL, RUND, QPAR51	843
DASAR® 1200 EL	831
DASAR® 215 RL, QUADRADO, QPAR111	847
DASAR® 215 RL, REDONDO, E27	847
DASAR® 215 RL, REDONDO, QPAR111	846
DASAR® 255 EL	839
DASAR® 270 EL, ASSIMÉTRICO	841
DASAR® 270 EL, SIMÉTRICO	841
DASAR® 370 EL, REDONDO	847
DASAR® 600 EL	831
DASAR® 920 EL	840
DASAR® 920 SP, 230V	698
DASAR® EXACT 116 EL, QUADRADO, QPAR51	845
DASAR® EXACT 116 EL, REDONDO, QPAR51	845
DASAR® FLAT 120 EL	839
DASAR® FLAT 80 EL	839
DASAR® L RL, QUADRADO	835
DASAR® L RL, REDONDO	835
DASAR® PROJECTOR SP, 12/24V	698
DASAR® S RL, QUADRADO	833
DASAR® S RL, REDONDO	833
DASAR® XL RL, QUADRADO	837
DASAR® XL RL, REDONDO	837
DEKLED EL	234
DELWA WL	767
DENA 30 WL, E14	373
DIO FLEX PLATE WL	387
DIO FLEX PLATE WL QPAR51	387
DIRETO 60 WL, PHASE	370
DIRETO 90 WL, PHASE	370
DISPLAY ADL 50 QPAR51	389
DL 126 EL	227
DORISA 30 WL	339
DORISA 50 WL	339
DOWNUNDER OUT L EL	823
DOWNUNDER OUT M EL	823
DOWNUNDER OUT S EL	823
DOWNUNDER OUT WL, QUADRADO	769
DOWNUNDER OUT WL, REDONDO	769
DOWNUNDER PUR 150 EL	242
DOWNUNDER PUR 80 EL	242
DURNO LV	489

<b>E</b>	
ENOLA B CL, QPAR51	259
ENOLA B CW, DOUBLE, QPAR51	407
ENOLA B CW, SINGLE, QPAR51	407
ENOLA B PD, QPAR51	305, 517
ENOLA B TRACK MONOF., QPAR51	517
ENOLA B WL, QPAR51	379
ENOLA C CL	259
ENOLA C TRACK MONOF.	517
ENOLA C TRACK MONOF.	516
ENOLA C TRACK TRIF.	561
ENOLA M LENTE ASSIMÉTRICA	731
ENOLA M LENTE DE 19°	731
ENOLA OCULUS CL	792

ENOLA OCULUS WL, SINGLE	723
ENOLA OCULUS WL, UP/DOWN	723
ENOLA PD, E27	305
ENOLA ROUND L CL	793
ENOLA ROUND L WL, SINGLE	725
ENOLA ROUND M CL	793
ENOLA ROUND M WL, SINGLE	725
ENOLA ROUND S CL	793
ENOLA ROUND S WL, SINGLE	725
ENOLA S, M, L REFLECTOR, 56°	731
ENOLA SQUARE L CL	795
ENOLA SQUARE L WL, SINGLE	729
ENOLA SQUARE M CL	795
ENOLA SQUARE M WL, SINGLE	729
ENOLA SQUARE S CL	795
ENOLA SQUARE S WL, SINGLE	729
ESKINA 30 POLE	631
ESKINA 80 POLE	631
ESKINA D DISPLAY, PHASE	783
ESKINA FRAME 125 POLE, DOUBLE	630
ESKINA FRAME 175 POLE, DOUBLE	630
ESKINA FRAME 45 POLE, SINGLE	629
ESKINA FRAME 75 POLE, DOUBLE	629
ESKINA FRAME 75 POLE, SINGLE	629
ESKINA FRAME CL, SINGLE	791
ESKINA FRAME WL	749
ESKINA FRAME WL, DOUBLE	749
ESKINA SPOT CW, PHASE	807
ESKINA SPOT SENSOR CW, PHASE	807
EURO CUBE TRIF.	555
EURO SPOT TRACK MONOF., QPAR51	521
EURO SPOT TRACK TRIF., QPAR111	555
EURO SPOT TRACK TRIF., QPAR51	555

<b>F</b>	
F-POL POLE, E27	672
F-POL WL, E27	778
FENDA 15 CM, REDONDO	448
FENDA 30 CM, REDONDO	449
FENDA BOW BASIS FL, E27	448
FENDA FL, E27	447, 448
FENDA Ø 45 CM, REDONDO	449
FENDA Ø 70 CM, REDONDO	449
FENDA PD, E27	296
FENDA TL, E27	447
FERA 25 CL	272
FERA 25 CL, DALI	272
FITU CUBE WL, E27	376
FITU PD, E27	295
FLAC BEAM® SP	693
FLATT 100 POLE	679
FLATT 65 POLE	679
FLATT SENSOR WL	760
FLATT WL	760
FLOODI L SP	691
FLOODI M SP	691
FLOODI S SP	691
FORCHINI 50 PD, E27	312
FORCHINI 70 PD, E27	312
FORCHINI M 40 PD, E27	313
FORCHINI M 40 TRACK MONOF., E27	512
FORCHINI M 40 TRACK TRIF., PD, E27	554
FORCHINI M 50 PD, E27	313
FRAME BASIC	238
FRAME BASIC RL, HV	238
FRAME BASIC SET RL	238
FRAME CURVE EL	239

<b>G</b>	
GALEN 120 SP	692
GALEN 60 SP	692
GIMBLE OUT EL	849
GLENOS® 60 WL	339
GLENOS® PD, 1M, 1-10V	291
GLENOS® PD, 2M, 1-10V	291
GLOO PURE 27 POLE, E27	655
GLOO PURE 44 POLE, E27	655
GLOO PURE 70 POLE, E27	655
GLOO PURE WL, E27	777
GRAFIT 30 POLE, E27	637
GRAFIT 30 POLE, REDONDO, E27	635
GRAFIT 60 POLE, E27	637
GRAFIT 60 POLE, REDONDO, E27	635
GRAFIT 90 POLE, E27	637
GRAFIT 90 POLE, REDONDO, E27	635

GRAFIT WL, E27	743
GRAFIT WL, QUADRADO, SENSOR, E27	743
GRAFIT WL, REDONDO, E27	742
GRAFIT WL, REDONDO, SENSOR, E27	742
GRAZIA FLEXSTRIP LED 24V	582
GRAZIA IP FLEXSTRIP 24V	591
GRAZIA IP FLEXSTRIP RGBW, 24V	591
GRAZIA IP FLEXSTRIP TUNABLE WHITE, 24V	591
GRAZIA PRO FLEXSTRIP 24V	583, 584
GRAZIA PRO FLEXSTRIP RGBW, 24V	589
GRAZIA PRO FLEXSTRIP TUNABLE WHITE, 24V	589
TUNABLE WHITE, 24V	587
GRAZIA PRO MAX FLEXSTRIP 24V	585, 586
GRAZIA 10 PERFIL SALIENTE, PLANO 2 M	567
GRAZIA 10 PERFIL SALIENTE DE ALUMÍNIO PADRÃO	567
GRAZIA 10 ACESSÓRIOS	569
GRAZIA 10 EDGE 2 M	570
GRAZIA 10 PERFIL DE ENCASTRAR	567
GRAZIA 10 EDGE ACESSÓRIOS	571
GRAZIA 20 PERFIL SALIENTE PLANO, 3 M	573
GRAZIA 20 PERFIL SALIENTE DE ALUMÍNIO PADRÃO, 3 M	573
GRAZIA 20 PERFIL DE ENCASTRAR 3 M	573
GRAZIA 20 ACESSÓRIOS	574, 575
GRAZIA 60 PERFIL SALIENTE	577
GRAZIA 60 PERFIL DE ENCASTRAR	577
GRAZIA 60 ACESSÓRIOS	578, 579

<b>H</b>	
H-POL 30 POLE	676
H-POL 60 POLE	676
H-POL TWIN 30 POLE	677
H-POL TWIN 60 POLE	677
HELIA 30 PD	301
HELIA 30 PD, PHASE	301
HELIA 40 PD	303
HELIA 40 PD, PHASE	303
HELIA 50 TRACK MONOF.	507
HELIA 50 TRACK TRIF.	561
HELIA AMBIENT 35 PD	300
HELIA AMBIENT 35 PD, PHASE	300
HELIA CW, DOUBLE, PHASE	809
HELIA CW, SINGLE, PHASE	809
HELIA SPOT L SP, SINGLE, PHASE	699
HELIA SPOT S SP, SINGLE	699
HORN DL, DOUBLE, QPAR51	219
HORN DL, SINGLE, QPAR51	219, 220
HORN EL, SINGLE, QPAR51	220
HORN MAGNA EL	221
HORN MINI EL	218
HORN-T EL, QPAR111	221

<b>I</b>	
I-PENDANT PRO PD, 1195X295MM, DALI	289
I-RING POLE	613
I-RING WL	714
IMPERVA 120 CW	817
IN-LINE 22 48V, DARKLIGHT REFLECTOR, DALI	473
IN-LINE 22 48V, OPAL, DALI	473
IN-LINE 24 48V, MOVE, OPAL, DALI	477
IN-LINE 44 48V, DARKLIGHT REFLECTOR, DALI	475
IN-LINE 44 48V, OPAL, DALI	475
IN-LINE 46 48V, MOVE, DARKLIGHT REFLECTOR, DALI	477
INDA CW, QPAR51	409
IPERI 50 POLE	681
IPERI WL	780

<b>K</b>	
KADUX DL, DOUBLE, PHASE	213
KADUX DL, SINGLE, PHASE	213
KADUX DL, TRIPLE, PHASE	213
KADUX EL, DOUBLE, QPAR111	215
KADUX EL, DOUBLE, QPAR51	214
KADUX EL, SINGLE, QPAR111	215
KADUX EL, SINGLE, QPAR51	214
KADUX EL, TRIPLE, QPAR51	214
KALU CW, DOUBLE, PHASE	403
KALU CW, DOUBLE, QPAR111	405
KALU CW, QUAD, PHASE	403
KALU CW, QUAD, QPAR111	405
KALU CW, SINGLE, PHASE	403

KALU CW, SINGLE, QPAR111 \_\_\_\_\_ 405  
 KALU CW, TRIPLE, PHASE \_\_\_\_\_ 403  
 KALU CW, TRIPLE, QPAR111 \_\_\_\_\_ 405  
 KALU TRACK MONOF., PHASE \_\_\_\_\_ 520  
 KALU TRACK MONOF., QPAR111 \_\_\_\_\_ 520  
 KALU TRACK TRIF., QPAR111 \_\_\_\_\_ 558  
 KALU TRACK LED TRIF., PHASE \_\_\_\_\_ 558  
 KARPO 30 CW, SINGLE \_\_\_\_\_ 399  
 KARPO 30 EL \_\_\_\_\_ 232  
 KARPO 30 WL, SINGLE \_\_\_\_\_ 383  
 KARPO FL \_\_\_\_\_ 452  
 KARPO GOOSE WL \_\_\_\_\_ 382  
 KARPO MAGN CW, SINGLE, PHASE \_\_\_\_\_ 382  
 KARPO TL \_\_\_\_\_ 452  
 KARPO WL \_\_\_\_\_ 383  
 KENKUA SPOT WL, E27 \_\_\_\_\_ 381  
 KERAS ELT WL, E27 \_\_\_\_\_ 779  
 KINI EL, PHASE \_\_\_\_\_ 237

**L**

L-LINE 120 WL \_\_\_\_\_ 341  
 L-LINE 60 WL \_\_\_\_\_ 341  
 L-LINE OUT 30 FL, VERTICAL \_\_\_\_\_ 650  
 L-LINE OUT 50 POLE, HORIZONTAL \_\_\_\_\_ 651  
 L-LINE OUT 60 FL, VERTICAL \_\_\_\_\_ 651  
 L-LINE OUT 80 POLE, HORIZONTAL \_\_\_\_\_ 651  
 L-LINE OUT WL \_\_\_\_\_ 775  
 LALU® CONE 15 ABAJUR \_\_\_\_\_ 178  
 LALU® ELYPSE 15 ABAJUR \_\_\_\_\_ 178  
 LALU® ELYPSE 22 ABAJUR \_\_\_\_\_ 178  
 LALU® ELYPSE 33 ABAJUR \_\_\_\_\_ 178  
 LALU® PD, E27 \_\_\_\_\_ 183  
 LALU® PD, LED BASE, PHASE \_\_\_\_\_ 177  
 LALU® PD, LED BASE, PHASE, RECESSED \_\_\_\_\_ 177  
 LALU® PLATE 15 ABAJUR \_\_\_\_\_ 178  
 LALU® PLATE 22 ABAJUR \_\_\_\_\_ 178  
 LALU® SHADE, E27 BASE \_\_\_\_\_ 183  
 LALU® TETRA 14 ABAJUR \_\_\_\_\_ 178  
 LALU® TETRA 24 ABAJUR \_\_\_\_\_ 178  
 LALU® TETRA 36 ABAJUR \_\_\_\_\_ 178

**LÂMPADA**

LED A60 E27 \_\_\_\_\_ 864  
 LED A60 E27 \_\_\_\_\_ 864  
 LED A60 E27 \_\_\_\_\_ 864  
 LED A60 E27, MIRRORHEAD, CHROM \_\_\_\_\_ 865  
 LED A60 E27, RGBW, SMART \_\_\_\_\_ 864  
 LED A60 E27, TUNABLE 2700-6500K, SMART \_\_\_\_\_ 864  
 LED C35 E14 \_\_\_\_\_ 860  
 LED C35 E14 \_\_\_\_\_ 860  
 LED G125 E27 \_\_\_\_\_ 865  
 LED GU10 \_\_\_\_\_ 862  
 LED GU10 \_\_\_\_\_ 862  
 LED GU10 \_\_\_\_\_ 862  
 LED QPAR 111 GU10 \_\_\_\_\_ 863  
 LED QPAR 111 GU10 \_\_\_\_\_ 863  
 LED QPAR 111 GU10 \_\_\_\_\_ 863  
 LED QPAR111 GU10 \_\_\_\_\_ 862  
 LED QPAR111 GU10 \_\_\_\_\_ 863  
 LED QPAR111 GU10 \_\_\_\_\_ 863  
 LED QPAR111 GU10 \_\_\_\_\_ 864  
 LED QPAR51 GU10 \_\_\_\_\_ 861  
 LED QPAR51 GU10 \_\_\_\_\_ 862  
 LED QPAR51 GU10, RGBW, SMART \_\_\_\_\_ 861  
 LED QPAR51 GU10, TUNABLE 2700-6500K, SMART \_\_\_\_\_ 861  
 LED QR51 GU5.3 \_\_\_\_\_ 861  
 LED QT14 G9 \_\_\_\_\_ 860  
 LED QT-DE12 R7S, 118 MM \_\_\_\_\_ 860  
 LED QT-DE12 R7S, 78 MM \_\_\_\_\_ 860  
 LED ST58 E27 \_\_\_\_\_ 865  
 LED ST64 E27 \_\_\_\_\_ 865  
 LED T32 GU10 \_\_\_\_\_ 861  
 LED T38 E27 \_\_\_\_\_ 865  
 LED T45 E27 \_\_\_\_\_ 865  
 LED TCR-TSE GX53 \_\_\_\_\_ 860  
 QPAR111 GU10, RGBW, SMART \_\_\_\_\_ 862  
 QPAR111 GU10, RGBW, SMART \_\_\_\_\_ 862  
 QPAR111 GU10, TUNABLE 2700-6500K, SMART \_\_\_\_\_ 863  
 LED PANEL 620X620MM \_\_\_\_\_ 243  
 LED SPIKE SP \_\_\_\_\_ 701  
 LED SPOT SP \_\_\_\_\_ 785  
 LID I 45 POLE, SINGLE \_\_\_\_\_ 611

LID I 75 POLE, DOUBLE \_\_\_\_\_ 611  
 LID I WL, DOUBLE \_\_\_\_\_ 713  
 LID I WL, SINGLE \_\_\_\_\_ 713  
 LID II WL \_\_\_\_\_ 711  
 LID II WL, UP/DOWN \_\_\_\_\_ 711  
 LIGHT EYE® 150 MONOF., PD, QPAR111 \_\_\_\_\_ 511  
 LIGHT EYE® 150 PD, QPAR111 \_\_\_\_\_ 314  
 LIGHT EYE® 90 MONOF., QPAR51 \_\_\_\_\_ 511  
 LIGHT EYE® 90 PD, GU10 \_\_\_\_\_ 314  
 LIPSY® 30 CW, DOME \_\_\_\_\_ 423  
 LIPSY® 30 CW, DRUM \_\_\_\_\_ 425  
 LIPSY® 40 CW, DOME \_\_\_\_\_ 423  
 LIPSY® 40 CW, DRUM \_\_\_\_\_ 425  
 LIPSY® 40 CW, DRUM, DALI \_\_\_\_\_ 426  
 LIPSY® 50 CW, DOME \_\_\_\_\_ 423  
 LIPSY® 50 CW, DRUM \_\_\_\_\_ 425  
 LIPSY® 50 CW, DRUM, DALI \_\_\_\_\_ 426  
 LISENNE 40 POLE, E27 \_\_\_\_\_ 662  
 LISENNE 70 POLE, E27 \_\_\_\_\_ 662  
 LISENNE PD, E27 \_\_\_\_\_ 306  
 LISENNE WL, E27 \_\_\_\_\_ 375  
 LITTLE SUN TL \_\_\_\_\_ 443  
 LOGS 40 POLE \_\_\_\_\_ 633  
 LOGS 70 POLE \_\_\_\_\_ 633  
 LOGS IN L WL, PHASE \_\_\_\_\_ 363  
 LOGS IN WL \_\_\_\_\_ 362  
 LOGS IN WL, PHASE \_\_\_\_\_ 362  
 LOGS WL \_\_\_\_\_ 775  
 LONG GRILL CW \_\_\_\_\_ 430  
 LYGANT WL, DOUBLE \_\_\_\_\_ 325  
 LYGANT WL, SINGLE \_\_\_\_\_ 325

**M**

M-POL 30 POLE \_\_\_\_\_ 623  
 M-POL 60 POLE \_\_\_\_\_ 623  
 M-POL 90 POLE \_\_\_\_\_ 623  
 M-POL M POLEHEAD \_\_\_\_\_ 619  
 M-POL M POLEHEAD, DALI \_\_\_\_\_ 619  
 M-POL M POLEHEAD, LOUVER \_\_\_\_\_ 621  
 M-POL M POLEHEAD, LOUVER, DALI \_\_\_\_\_ 621  
 M-POL M POLEHEAD, SHADER \_\_\_\_\_ 620  
 M-POL M POLEHEAD, SHADER, DALI \_\_\_\_\_ 620  
 M-POL S POLEHEAD \_\_\_\_\_ 616  
 M-POL S POLEHEAD 180°, OFUSCAMENTO ELIMINADO \_\_\_\_\_ 615  
 M-POL S POLEHEAD 180°, OFUSCAMENTO ELIMINADO, DALI \_\_\_\_\_ 615  
 M-POL S POLEHEAD 360°, OFUSCAMENTO ELIMINADO \_\_\_\_\_ 614  
 M-POL S POLEHEAD 360°, OFUSCAMENTO ELIMINADO, DALI \_\_\_\_\_ 614  
 M-POL S POLEHEAD, DALI \_\_\_\_\_ 617  
 M-POL S POLEHEAD, LOUVER \_\_\_\_\_ 618  
 M-POL S POLEHEAD, LOUVER, DALI \_\_\_\_\_ 618  
 M-POL S POLEHEAD, SHADER \_\_\_\_\_ 617  
 M-POL S POLEHEAD, SHADER, DALI \_\_\_\_\_ 617  
 MAGANDA TL \_\_\_\_\_ 453  
 MAGANDA WL \_\_\_\_\_ 337  
 MANA BASE WL, REDONDO, PHASE \_\_\_\_\_ 720  
 MANA OUT WL, PHASE \_\_\_\_\_ 721  
 MANA OUT WL, SET \_\_\_\_\_ 721  
 MARONA CL, PHASE \_\_\_\_\_ 273  
 MARYLIN 40/60/90 WL \_\_\_\_\_ 333  
 MEDO® 30 CW, PHASE \_\_\_\_\_ 161  
 MEDO® 30 EL, CAIXA DE MONTAGEM PARA ENCASTRAR \_\_\_\_\_ 171  
 MEDO® 30 EL, SEM MOLDURA \_\_\_\_\_ 170  
 MEDO® 40 CW, PHASE \_\_\_\_\_ 161  
 MEDO® 40 EL, CAIXA DE MONTAGEM PARA ENCASTRAR \_\_\_\_\_ 171  
 MEDO® 40 EL, SEM MOLDURA \_\_\_\_\_ 170  
 MEDO® 60 CL, QUADRADO, 1-10V \_\_\_\_\_ 165  
 MEDO® 60 CL, QUADRADO, DALI \_\_\_\_\_ 165  
 MEDO® 60 CW, PHASE \_\_\_\_\_ 161  
 MEDO® 60 EL, CAIXA DE MONTAGEM PARA ENCASTRAR \_\_\_\_\_ 171  
 MEDO® 60 EL, SEM MOLDURA \_\_\_\_\_ 170  
 MEDO® 90 CL, PHASE \_\_\_\_\_ 161  
 MEDO® PRO 30 CW, DALI \_\_\_\_\_ 152  
 MEDO® PRO 30 CW, DALI, UGR<19 \_\_\_\_\_ 150  
 MEDO® PRO 30 CW, DALI, UGR<19, DC \_\_\_\_\_ 157  
 MEDO® PRO 30 CW, PHASE \_\_\_\_\_ 152  
 MEDO® PRO 30 CW, PHASE, UGR<19 \_\_\_\_\_ 150  
 MEDO® PRO 40 CW, DALI \_\_\_\_\_ 152  
 MEDO® PRO 40 CW, DALI, UGR<19 \_\_\_\_\_ 150

MEDO® PRO 40 CW, DALI, UGR<19, DC \_\_\_\_\_ 157  
 MEDO® PRO 40 CW, PHASE \_\_\_\_\_ 152  
 MEDO® PRO 40 CW, PHASE, UGR<19 \_\_\_\_\_ 150  
 MEDO® PRO 60 CW, DALI \_\_\_\_\_ 153  
 MEDO® PRO 60 CW, DALI, UGR<19 \_\_\_\_\_ 151  
 MEDO® PRO 60 CW, DALI, UGR<19, DC \_\_\_\_\_ 157  
 MEDO® PRO 60 CW, PHASE \_\_\_\_\_ 153  
 MEDO® PRO 60 CW, PHASE, UGR<19 \_\_\_\_\_ 151  
 MEDO® PRO 90 CL, DALI \_\_\_\_\_ 153  
 MEDO® PRO 90 CL, DALI, UGR<19 \_\_\_\_\_ 151  
 MEDO® PRO 90 CL, DALI, UGR<19, DC \_\_\_\_\_ 157  
 MEDO® PRO 90 CL, PHASE \_\_\_\_\_ 153  
 MEDO® PRO 90 CL, PHASE, UGR<19 \_\_\_\_\_ 151  
 MEDO® RING 60 PD, 1-10V \_\_\_\_\_ 167  
 MEDO® RING 60 PD, DALI \_\_\_\_\_ 167  
 MEDO® RING 90 PD, 1-10V \_\_\_\_\_ 167  
 MELAN CW, E27 \_\_\_\_\_ 427  
 MERADO FLOOD WL, PHASE \_\_\_\_\_ 388  
 MERIDIAN BOX SENSOR WL, E27 \_\_\_\_\_ 747  
 MERIDIAN BOX WL, E27 \_\_\_\_\_ 746, 747  
 MERIDIAN WL, E27 \_\_\_\_\_ 746  
 MIBO UP/DOWN WL, QT14 \_\_\_\_\_ 337  
 MILANDOS 4 DL \_\_\_\_\_ 217  
 MILANDOS 6 DL \_\_\_\_\_ 217  
 MILANDOS 8 DL \_\_\_\_\_ 217  
 MOBALA EL \_\_\_\_\_ 243  
 MOLAT CL, E27 \_\_\_\_\_ 799  
 MOLAT PD, E27 \_\_\_\_\_ 661  
 MOLAT POLE, E27 \_\_\_\_\_ 661  
 MOLAT WL, E27 \_\_\_\_\_ 777  
 MYRA CW, SINGLE, QPAR51 \_\_\_\_\_ 785  
 MYRA DISPLAY WL, CURVED, QPAR51 \_\_\_\_\_ 783  
 MYRA SPOT DOUBLE, GU10 \_\_\_\_\_ 685  
 MYRA UP/DOWN WL, QPAR51 \_\_\_\_\_ 764  
 MYRA WL, DOUBLE, QPAR51 \_\_\_\_\_ 811  
 NAGY 75 CL, QPAR51 \_\_\_\_\_ 261

**N**

NAUTILUS 10 SP, QUADRADO \_\_\_\_\_ 696  
 NAUTILUS 10 SP, REDONDO, QPAR51 \_\_\_\_\_ 694, 695  
 NAUTILUS 10 SPOT LED SP \_\_\_\_\_ 697  
 NAUTILUS 10 SPOT SP, QPAR51 \_\_\_\_\_ 697  
 NAUTILUS SP, QR-C51 \_\_\_\_\_ 697  
 NAUTILUS WL QPAR51 \_\_\_\_\_ 785  
 NEW TRIA® 150 DL, QUADRADO, QPAR111 \_\_\_\_\_ 145  
 NEW TRIA® 150 DL, REDONDO, QPAR111 \_\_\_\_\_ 145  
 NEW TRIA® 155 DL, DOUBLE \_\_\_\_\_ 141  
 NEW TRIA® 155 DL, DOUBLE, QPAR51 \_\_\_\_\_ 145  
 NEW TRIA® 300 DL, DOUBLE, QPAR111 \_\_\_\_\_ 145  
 NEW TRIA® 45 DL, REDONDO \_\_\_\_\_ 141  
 NEW TRIA® 68 DL, QUADRADO, DTW, PHASE \_\_\_\_\_ 135  
 NEW TRIA® 68 DL, QUADRADO, PHASE \_\_\_\_\_ 134  
 NEW TRIA® 68 DL, QUADRADO, QPAR51 \_\_\_\_\_ 138  
 NEW TRIA® 68 DL, REDONDO, DTW, PHASE \_\_\_\_\_ 135  
 NEW TRIA® 68 DL, REDONDO, PHASE \_\_\_\_\_ 134, 135  
 NEW TRIA® 68 DL, REDONDO, QPAR51 \_\_\_\_\_ 138  
 NEW TRIA® 75 DL, QUADRADO, QPAR51 \_\_\_\_\_ 138  
 NEW TRIA® 75 DL, REDONDO, PHASE \_\_\_\_\_ 137  
 NEW TRIA® 75 DL, REDONDO, QPAR51 \_\_\_\_\_ 138  
 NEW TRIA® 75 XL DL, QUADRADO, QPAR51 \_\_\_\_\_ 139  
 NEW TRIA® 75 XL DL, REDONDO, QPAR51 \_\_\_\_\_ 139  
 NEW TRIA® UNIVERSAL 68 DL, QUADRADO, PHASE \_\_\_\_\_ 136, 137  
 NEW TRIA® UNIVERSAL 68 DL, REDONDO, PHASE \_\_\_\_\_ 136, 137  
 NOBLO® CW, DOUBLE, PHASE \_\_\_\_\_ 401  
 NOBLO® CW, SINGLE, PHASE \_\_\_\_\_ 401  
 NOBLO® CW, TRIPLE, PHASE \_\_\_\_\_ 401  
 NOBLO® SPOT LV, ROPE TRACK \_\_\_\_\_ 491  
 NOBLO® SPOT MONOF., PHASE \_\_\_\_\_ 501, 503  
 NOBLO® SPOT MONOF., TRIPLE TRACK SET \_\_\_\_\_ 501  
 NOBLO® SPOT TRIF., PHASE \_\_\_\_\_ 545, 547  
 NOTAPO L RL \_\_\_\_\_ 241  
 NOTAPO S RL \_\_\_\_\_ 241  
 NOYA PD, PHASE \_\_\_\_\_ 290  
 NUMINOS® 3 PH. \_\_\_\_\_ 110-113  
 NUMINOS® CL \_\_\_\_\_ 103-105  
 NUMINOS® CW \_\_\_\_\_ 99-101  
 NUMINOS® DL \_\_\_\_\_ 83-85  
 NUMINOS® GIMBLE DL \_\_\_\_\_ 88-89  
 NUMINOS® MOVE DL \_\_\_\_\_ 86-87  
 NUMINOS® PD \_\_\_\_\_ 106-109

NUMINOS® PROJECTOR DL	91-93
NUMINOS® S LUMINÁRIA SUSPENSA 48V, DALI	471
NUMINOS® S SPOT 48V, DALI	469
NUMINOS® XS LUMINÁRIA SUSPENSA 48V, DALI	471
NUMINOS® XS SPOT 48V, DALI	469
NUMINOS® ZOOM SISTEMA TRACK TRIFÁSICO	115
NUMINOS® ACESSÓRIOS	94-95

**O**

OCCULDAS 13 CL, INDIRETO, PHASE	262
OCCULDAS 23 CL, INDIRETO, PHASE	262
OCULUS CL, MOVE, PHASE	229
OCULUS CL, PHASE	258
OCULUS CW, PHASE	399
OCULUS PD, SINGLE, PHASE	294
OCULUS UP/DOWN WL, PHASE	355
OCULUS WL, SINGLE, PHASE	355
ONE® 40 CW, DALI	193
ONE® 60 CW, DALI	193
ONE® 60 PD, DALI	188
ONE® 60 PD, UP/DOWN, DALI	188
ONE® 60 PD, UP/DOWN, PHASE	188
ONE® 80 PD, DALI	188
ONE® 80 PD, UP/DOWN, DALI	188
ONE® BOW FL, UP/DOWN	197
ONE® CUBE PD, DALI	189
ONE® CUBE PD, UP/DOWN, DALI	189
ONE® DOUBLE PD, UP/DOWN, DALI	189
ONE® DOUBLE PD, UP/DOWN, PHASE	189
ONE® LINEAR 100 PD, UP/DOWN, PHASE	191
ONE® LINEAR 140 PD, UP/DOWN, PHASE	191
ONE® STRAIGHT FL, UP/DOWN	196
ONE® TRIPLE PD, DALI	189
ORDI SENSOR WL	771
ORDI WL	771
OSSA 180 WL, QT-DE12	367
OSSA 300 WL, QT-DE12	367
OTOS GLAS POLE, E27	659
OUT-BEAM FRAME SP	811
OVAL 14 WL, UP/DOWN	715
OVAL 18 WL, UP/DOWN	715
OVALISK 100 POLE	653
OVALISK 75 POLE	653
OVALISK CL	797
OVALISK SENSOR WL	757
OVALISK WL	757

**P**

PANEL CL, 1200X300MM, DALI	275
PANEL CL, 1200X300MM, PHASE	275
PANEL TRACK MONOF., QUADRADO	507
PANEL TRACK MONOF., REDONDO	507
PANTILLO 20 PD, E27	281
PANTILLO 28 PD, E27	281
PANTILLO CONVEX 29 PD, E27	283
PANTILLO CONVEX 40 PD, E27	283
PANTILLO OVAL PD, E27	281
PANTILLO ROPE 19 CW, E27	393
PANTILLO ROPE 19 PD, E27	279, 505, 549
PANTILLO ROPE 20 PD, E27	279
PANTILLO ROPE 27 CW, E27	393
PANTILLO ROPE 27 PD, E27	279
PANTILLO ROPE WL, G9	345
PARA 380 PD, E27	319
PARA CONE 14 MONOF., PD, QPAR51	509
PARA CONE 14 MONOF., QPAR51	509
PARA CONE 14 TRIF., PD, QPAR51	553
PARA CONE 14 TRIF., QPAR51	553
PARA CONE 20 PD, E27	309
PARA CONE 30 PD, E27	309
PARA CONE GL MONOF., GU10	508
PARA CONE GL TRIF., GU10	552
PARA CONE GL PD, GU10	309, 508, 552
PARA DOME PD, E27	318
PARA DOME ABAJUR	318
PATTA-I EL, REDONDO, PHASE	244, 245
PATTA-I EL, QUADRADO, PHASE	244, 245
PATTA-F EL, REDONDO, PHASE	246
PATTA-F EL, QUADRADO, PHASE	247
PEMA® WL	758, 759
PEMA® WL, E27	759
PHELIA 10 PD, E27	310

PHELIA 20 PD, E27	311
PHELIA 25 PD, E27	311
PHELIA 30 PD, E27	311
PHELIA FL, E27	453
PHELIA WL, QPAR51	388
PHOTONI 45 POLE, E27	605
PHOTONI 75 POLE, E27	605
PHOTONI CL, E27	789
PHOTONI WL, E27	709
PHOTONIA CL, E27	799
PHOTONIA PD, E27	659
PHOTONIA POLE, E27	659
PHOTONIA WL, E27	777
PLASTRA 101 WL, E14	361
PLASTRA 104 CL, E27	271
PLASTRA 104 WL, QT14	361
PLASTRA 105 CL, E27	271
PLASTRA CL, PHASE	271
PLASTRA CL, QPAR51	270
PLASTRA WL, CUBE, QT14	356
PLASTRA WL, CUBES	356
PLASTRA WL, CURVE, QT-DE12	361
PLASTRA WL, E14	357
PLASTRA WL, QPAR51	360
PLYTTA LV	490
POWER TRAIL-LITE® EL, QUADRADO	849
POWER TRAIL-LITE® EL, REDONDO	849
PURI CW, DOUBLE, QPAR51	411
PURI CW, QUAD, QPAR51	411
PURI CW, SINGLE, QPAR51	411
PURI CW, TRIPLE, QPAR51	411
PURI TRACK MONOF., QPAR51	513
PURI TRACK MONOF., TRIPLE TRACK SET	513
PURI TRACK TRIF., QPAR51	557
PURI TRACK GLASS TRIF., QPAR51	557
PURIA TRACK MONOF., QPAR51	515

**Q**

Q-LINE® CL, 1M, BAP, PHASE	253
Q-LINE® CL, 2M, BAP, PHASE	253
Q-LINE® PD, 1M, BAP, PHASE	293
Q-LINE® PD, 2M, BAP, PHASE	293
Q-LINE® PD, DALI, SINGLE	293
Q-LINE® WL	341
QUAD FRAME 14 WL	364
QUAD FRAME 19 WL	364
QUAD FRAME 9 WL	240
QUAD POLE	683
QUAD UP/DOWN 15 WL	753
QUAD WL	752
QUADRASS PD, E27	307
QUADRASS SPOT WL, E27	375
QUADRASS WL, E27	375
QUADRASYL 75 POLE, TCR-TSE	682
QUADRASYL WL, TCR-TSE	781
QUADRULO CL	811
QUADRULO FL	639
QUADRULO SENSOR WL, E27	745
QUADRULO WL	744
QUADRULO WL, E27	745

**R**

R-CUBE 35 POLE	609
R-CUBE 75 POLE	609
R-CUBE CW	805
RASCALI 45 POLE	684
RASCALI 65 POLE	684
RASCALI WL	780
ROCCI 200 EL, QUADRADO	855
ROCCI 200 EL, REDONDO	855
ROCCI EL, QUADRADO	854
ROCCI EL, REDONDO	854
ROTOBALL 25 FL, E27	657
ROTOBALL 25 PD, E27	317
ROTOBALL 40 FL, E27	657
ROTOBALL 40 PD, E27	317
ROTOBALL 50 FL, E27	657
ROTOBALL 50 PD, E27	317
ROX ACRYL 30 POLE, E27	669
ROX ACRYL 60 POLE, E27	669
ROX ACRYL 90 POLE, E27	669
ROX CL, GX53	801
ROX CL, QPAR111	801
ROX UP/DOWN WL, QPAR111	767
ROX WL, QPAR111	767

RUBA CW	814
RUSTY® 40 POLE	642
RUSTY® 40 POLE, E27	643, 646
RUSTY® 70 POLE	643
RUSTY® 70 POLE, E27	643, 646
RUSTY® CONE 24 FL, E14	645
RUSTY® CONE 40 POLE, E27	645
RUSTY® CONE 70 POLE, E27	645
RUSTY® MANA ABAJUR, QUADRADO	720
RUSTY® MANA ABAJUR, REDONDO	720
RUSTY® PATHLIGHT POLE, TCR-TSE	642
RUSTY® SLOT 50 POLE	640
RUSTY® SLOT 50 POLE, E27	641
RUSTY® SLOT 80 POLE	640
RUSTY® SLOT 80 POLE, E27	641
RUSTY® UP/DOWN WL, QUADRADO	756
RUSTY® UP/DOWN WL, REDONDO	756

**S**

S-CUBE 35 POLE	607
S-CUBE 75 POLE	607
S-CUBE CL	791
S-CUBE CW	805
S-TUBE 32 POLE, GU10	603
S-TUBE 75 POLE, GU10	603
S-TUBE CW	805
SALUNA LV, QR-C51	489
SAMRINA SP, SINGLE, GU10	693
SEDO 14 WL	329
SEDO 21 WL	329
SEDO 7 WL	329
SHELL 15 WL, PHASE	365
SHELL 30 WL, PHASE	365
SIGHT 115 CW	431
SIGHT 60 CW	431
SIGHT MOVE TRIF.	551
SIGHT MOVE TRIF., DALI	551
SIGHT TRACK TRIF.	550
SIGHT TRACK TRIF., DALI	550
SITRA 360 CW, TCR-TSE	808
SITRA 360 POLE, TCR-TSE	685
SITRA 360 SPIKE SP, DOUBLE, TCR-TSE	703
SITRA 360 SPIKE SP, SINGLE, TCR-TSE	703
SITRA CL, TCR-TSE	801
SITRA CUBE WL, TCR-TSE	741
SITRA L WL, UP/DOWN, QUADRADO	741
SITRA M WL, UP/DOWN, QUADRADO	741
SITRA S WL, SINGLE, QUADRADO	739
SITRA UP/DOWN WL	765
SITRA UP/DOWN WL, TCR-TSE	765
SITRA WL, TCR-TSE	779
SLOTBOX 40 POLE	678
SLOTBOX 70 POLE	678
SLOTS 45 POLE	675
SLOTS 65 POLE	675
SLOTS WL	768
SMALL PLOT COBERTURA, 2 PEÇAS	851
SMALL PLOT COBERTURA, 4 PEÇAS	851
SMALL PLOT MÓDULOS	851
SOLASTO EL, QUADRADO	857
SOLASTO EL, REDONDO	857
SOLID CUBE WL, QT14	377
SOPRANA CL, E27	269
SPOT 79 CW, QPAR51	409
SQUARE POLE 30 POLE, E27	673
SQUARE POLE 60 POLE, E27	673
SQUARE POLE 90 POLE, E27	673
SQUARE TURN WL, G9	781
SQUARE WL, E27	779
SUN / BIG SUN PD, E27	315
SYNA GARDEN SP	689
SYNA PLANT SP	689
SYNA SP	689
SYROS LV, QR-C51	489

**T**

TAHA CONJUNTO DE LUMINÁRIAS, BATERIA	441, 601
TELESKOP LV, QR-C51	486
TENORA CL, E27	268
TENSEO CABO DE BAIXA TENSÃO	482-484
TENSEO ACESSÓRIOS DE CABO DE BAIXA TENSÃO	485
TERANG 200 CW	817
THEO BRACKET CW	808



THEO BRACKET SP _____	701
THEO PATHLIGHT POLE, DOUBLE _____	652
THEO UP/DOWN WL, QPAR51 _____	377, 735
THEO WL, QPAR51 _____	736
TINY SUN TL _____	443
TODAY PRO DISPLAY _____	783
TONGA® MONOF., PD, E14 _____	511
TONGA® PD, E14 _____	307
TONILA TL _____	453, 601
TRAIL-LITE® 60 EL _____	848
TRUKKO 60 WL _____	332
TRUKKO 90 WL _____	332
TRUST 30 POLE _____	667
TRUST 60 POLE _____	667
TS V TRIF. _____	543

**U**

UNIVERSAL DOWNLIGHT DL	
WITH COVER, MULTIPACK _____	208, 209
UNIVERSAL DOWNLIGHT DL,	
MOVE, PHASE _____	207
UNIVERSAL DOWNLIGHT DL, PHASE _____	205

**V**

VANO WING SP, DALI _____	719
VAP SLIM 30 POLE, E27 _____	671
VAP SLIM 60 POLE, E27 _____	671
VAP SLIM 90 POLE, E27 _____	671
VARU EL, QPAR51 _____	234
VARYT CL, E14 _____	251
VARYT TL, E14 _____	443
VARYT WL, E14 _____	327
VILUA L WL _____	763
VILUA S WL _____	763
VILUA UP/DOWN, WL _____	763
VINOLINA ONE TL, ACUMULADOR _____	437, 597
VINOLINA TL, ACUMULADOR _____	437, 597
VINOLINA TWO TL, ACUMULADOR _____	439, 599

**W**

WALLYX WL, QPAR51 _____	768
WL 106 E14 _____	335
WL 149 WL, PHASE _____	334
WL 149 WL, QT-DE12 _____	334
WORKLIGHT FL _____	445
WORKLIGHT PD, DALI _____	288
WORKLIGHT PRO 120 PD, DALI _____	287
WORKLIGHT PRO 150 PD, DALI _____	287
WORKLIGHT PRO FL, DOUBLE _____	444
WORKLIGHT PRO FL, SINGLE _____	444
WORKLIGHT TL _____	445
WORO EL _____	243

# SIMBOLOGIA



## Recomendações

Mostra recomendações de acessórios e lâmpadas dos respetivos produtos

## MIX match

## Mix & Match

Identifica produtos que podem ser combinados individualmente



## Classe de eficiência energética

„Esta luminária é adequada para lâmpadas das classes energéticas ...”

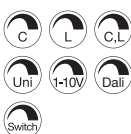

Regulável com:

- **C** = Dimmer de corte de fase inversa
- **L** = Dimmer de corte de fase (direta)
- **Uni** = Dimmer universal
- **1-10 V**
- **Dali** = Controlável através de protocolo DALI
- **Switch** = Interruptor/botão ou Touch Control na luminária



Classes de proteção

- Classe de proteção I / condutor de proteção
- Índice de proteção II / proteção por isolamento duplo ou reforçado
- Índice de proteção III / proteção por tensão reduzida



**IP**-Índice de proteção:

Determina a compatibilidade do equipamento elétrico para várias condições meteorológicas.



**IK**-Grau de resistência ao impacto:

O grau de resistência ao impacto IK é uma medida de resistência dos compartimentos de equipamentos elétricos à carga mecânica exercida, em particular, aos impactos.



Ângulo de meia dispersão:

Descreve o ângulo de radiação em graus. Quanto menor for o ângulo, maior é a concentração de luz.



Capacidade de rotação e oscilação em graus:

- Alcance de rotação
- Alcance da oscilação
- Cardan (rotação nos dois eixos)



**Unified Glare Rating:**

Quanto menor for o valor UGR, menor é o encandeamto.



Manutenção do fluxo luminoso:

Descreve quanto o fluxo luminoso de um LED diminui no período especificado.



Comprimento do cabo suspenso em cm



Comprimento do cabo de alimentação em cm  
Comprimento do cabo de alimentação em cm (cabo com extremidade aberta)



Formato da abertura de instalação



Especificação da profundidade de instalação



Capacidade de resistência à compressão do produto indicado



Capacidade de peso do produto até ao valor indicado em toneladas. As medições baseiam-se num pavimento em betão.



Permite a instalação de equipamento elétrico em materiais cujas características de inflamabilidade não são conhecidas.



Possibilidade de repicagem



Conversor independente:

Dispositivo de controlo também para utilização fora das luminárias



Dispositivo de controlo de segurança à prova de curto circuito



Utilização exclusivamente para espaços interiores. Inadequado para utilização em espaços interiores



Connected Lighting:

Identifica os produtos inteligentes que utilizam os seguintes protocolos:

- Zigbee®
- DALI
- Bluetooth



**CCT**-Interruptor:

Com o interruptor CCT integrado, a temperatura de cor da luz pode ser selecionada de 2700K, 3000K, 4000K ou 6500K durante a instalação.



Assinala luminárias com RGB+W e RGB (vermelho-verde-azul + branco e vermelho-verde-azul)



Dim-to-Warm:

Ao regular, a cor da luz muda de um branco mais frio para um branco mais quente.



- Produtos com LED integrados
- Produtos com casquilho de lâmpada

Uma grande parte dos produtos apresentados neste catálogo está protegida por marcas registadas, projetos, modelos de utilidade ou patentes. Uma violação destes direitos de propriedade ou o uso de design de texto e layout, bem como imagens protegidas por direitos de autor sem a nossa aprovação, será processada legalmente. As ilustrações e informações contidas neste catálogo são apenas para fins ilustrativos e não são vinculativas no que diz respeito a cor, formato, design e dados técnicos. Reserva-se, portanto, o direito a alterações e erros em todas as descrições/informações do produto.

Todos os produtos da nossa gama estão sujeitos a uma rigorosa garantia de qualidade e satisfazem as normas geralmente aplicáveis. Este catálogo contém uma gama geral e não é específico do país.

Quaisquer desvios dos requisitos específicos do país devem ser esclarecidos antes da encomenda. A SLV não se responsabiliza por eventuais normas técnicas divergentes. Todas as indicações de peso e comprimento são fornecidas em kg ou cm, salvo indicação em contrário. Sujeito a alterações técnicas!

A apresentação das nossas luzes com fotos realistas e exemplares da aplicação é possibilitada pela cortesia amigável e pelo consentimento dos proprietários ou projetistas dos ambientes que podem ser vistos principalmente nas imagens. Gostaríamos de aproveitar esta oportunidade para agradecer a todos os que contribuíram para a produção e utilização das nossas fotos!

Com a publicação deste catálogo, os preços nas listas e catálogos publicados anteriormente são inválidos. A SLV tem o direito de adaptar a respetiva lista de preços às alterações nas condições de mercado, no caso de alterações significativas nos custos de aquisição, alterações no imposto de valor acrescentado ou preços de aquisição.

Todos os preços são preços recomendados de venda ao público em euros sem IVA incluído.

Editor  
SLV GmbH, Deutschland  
Daimlerstraße 21-23  
52531 Übach-Palenberg  
T +49 (0) 2451 4833-0  
slv.com

Copyright  
© SLV GmbH, 2023



SLV GmbH | Daimlerstraße 21-23, 52531 Uebach-Palenberg, Germany, +49 (0) 2451 4833-333, info@slv.de  
SLV Austria | +49 (2451) 4833 355, export@slv.de  
SLV Belgium | Herentalsebaan 429, B-2160 Wommelgem, +32 (0) 3/385 30 08, info@slv.be  
SLV Nordics | Flade Engvej 4, 9900 Frederikshavn, Denmark, +45 9310 7474, info@nordics.slv.com  
SLV France | Zac du Martelet, 88, rue Henri Dépaigneux, F-69400 Limas, +33 4 74 02 71 20, infofr@slv.com  
SLV LIGHTING UK LTD | Unit E Chiltern Park, Boscombe Road, Dunstable, LU5 5LT, +44 (0)203 968 11 00, sales@uk.slv.com  
SLV Italia S.r.l. | Via Lecco, 19/D, 23896 Bevera di Sirtori (LC), +39 039 5983575, infoit@slv.com  
SLV Nederland | Kazernestraat 19, 5928 NL Venlo, +31 773204343, info@slv.nl  
SLV i Norge, del av SLV Nordics | Tors veg 9B, 7035 Trondheim, +47 4777 1080, post-no@slv.com  
SLV Poland | +48 (22) 7224975, slv@slv.pl  
SLV Portugal | R. Margarida de Abreu, no13 – Lj2, 1900-314 Lisboa, +351 210 185 961, info@pt.slv.com  
SLV Swiss SA | Route du Bey 6 Box 1-4, Z.I. La Jonnaire, CH-1847 Rennaz, +41 218113232, info@slv-swiss.ch  
SLV d.o.o | Barjanska cesta 50, SI-1000 Ljubljana, +386 1 2009 730, info@slv.si  
SLV Spain | Antic Cami Real Valencia, 38, L17, 08860 Castelldefels, Barcelona, 931 168 161, info@slv.es  
SLV Czech s.r.o. | V Sedlci 28/17, CZ-160 00 Praha 6, +420 739 282 151, info@cz.slv.com