

**50 Hz**

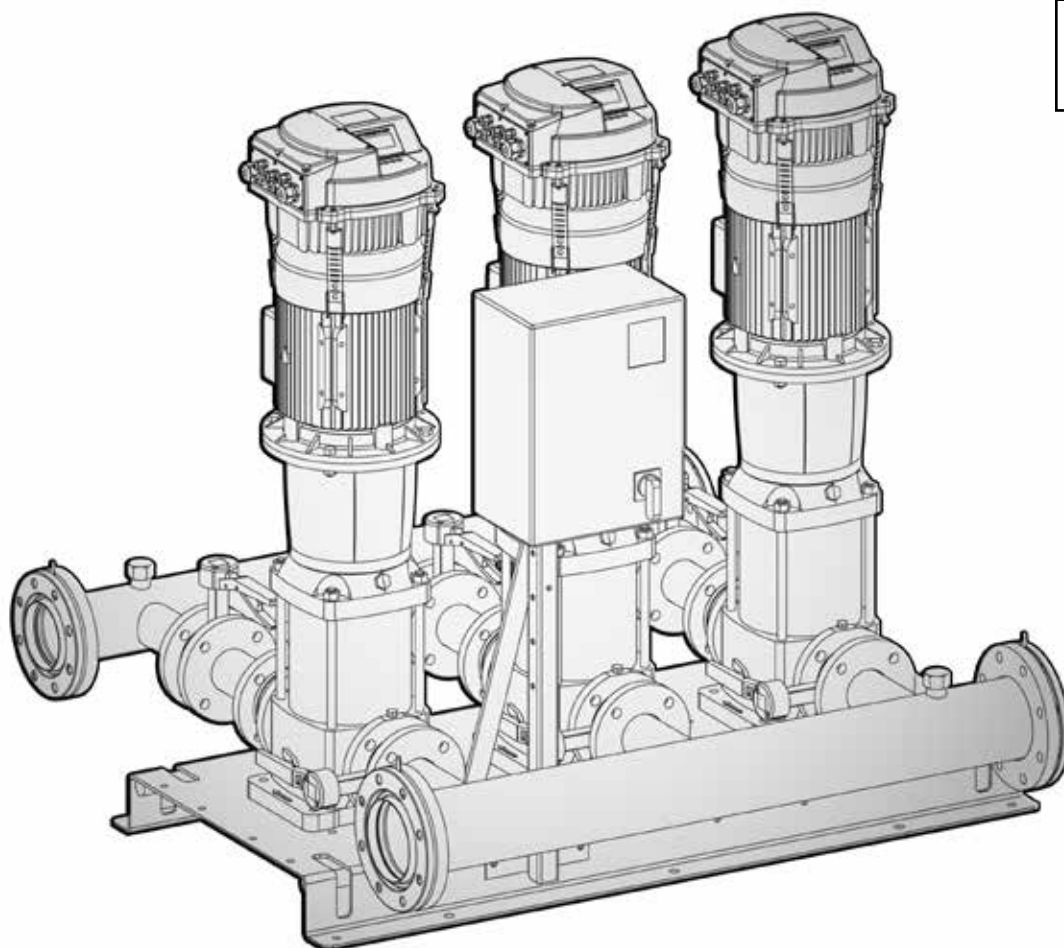

# GHV20-GHV30-GHV40 Series

VARIABLE SPEED BOOSTER SETS WITH HYDROVAR® (HVL SERIES)  
VERTICAL MULTISTAGE ELECTRIC PUMPS SERIES e-SV™



## CONTENTS

<b>General introduction</b> .....	<b>5</b>
Choice and selection .....	<b>13</b>
<b>GHV.../SV Series</b> .....	<b>19</b>
Electric pump range and characteristics .....	<b>21</b>
Hydraulic performance tables .....	<b>37</b>
Electrical data tables .....	<b>48</b>
<b>GHV20 Series</b> .....	<b>50</b>
<b>GHV30 Series</b> .....	<b>57</b>
<b>GHV40 Series</b> .....	<b>63</b>
Performance curves .....	<b>69</b>
Hc pressure drop curve .....	<b>98</b>
Accessories .....	<b>103</b>
Technical Appendix .....	<b>111</b>



## **GHV BOOSTER SETS SERIES**

### **GENERAL INTRODUCTION – PRODUCT DESCRIPTION**

Lowara GHV series booster sets are designed to transfer and increase the pressure of water, in the following applications:

- Hospitals
- Schools
- Public buildings
- Industries
- Hotels
- Condominiums
- Sports facilities
- Mains water systems

GHV series booster sets are variable speed pumping stations with two to four e-SV series multistage vertical pumps. Each pump is equipped with an HYDROVAR® frequency converter. This means that all the pumps are capable of variable speed operation. Special sets with up to 8 pumps are also available on request.

These types of systems improve the comfort of the end user, reducing noise emissions. Thanks to the gradual switching off of the pumps, “water hammer” is also reduced.

The pumps are installed on a single base and connected to each other by means of suction and delivery pipes. The pumps are connected to the manifolds by means of on-off valves and non-return valves. The control panel is secured to the same base by means of a bracket.

**GHV series booster sets with e-SV are certified for use with drinking water according to WRAS and ACS standards, and with Italian Ministry Decree no. 174.**

GHV series booster sets have been defined with a wide range of pumps to satisfy the different needs of every system. However, Lowara can also offer the GHV series with customisation to satisfy particular working requirements.

Systems for regulating the speed of the electric motors, as in GHV series booster sets, are used in the following cases:

- In the case of systems with a lot of users where the daily consumption varies frequently and in different periods.
- When it is necessary to obtain constant pressure.
- In the case of systems with supervision it is possible to monitor and check the performances of the pump stations.

**GHV BOOSTER SETS SERIES  
DESCRIPTION OF OPERATION**

In GHV series Lowara sets, all the pumps are controlled by a HYDROVAR® frequency converter, and operate at variable speeds.

Special sets with up to eight pumps are also available on request. Start-up is automatic, depending on system requirements. Each pump has a pressure transmitter that provides a pressure reading, which is recorded and sent to the frequency converter.

The pump speed is modulated based on system requirements.

Pump start alternation is automatic, following a preset time (parameter available in the frequency converter).

Pump starts and stops are determined based on the pressures entered as set values in the menu of the frequency converter.

**Example operation of a set of three GHV series pumps.**

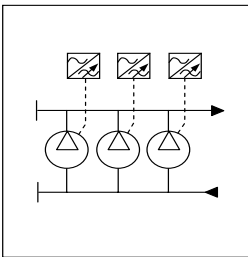

Each pump is controlled by a frequency converter, directly connected to the pump electric motor. The starting priority is changed in accordance with the time set in the relevant HYDROVAR® parameter field. The speed adjustment will apply to all the pumps installed. When the water request decreases, the pumps stop in succession.

The pumps connected to the frequency converter keep the pressure constant by modulating the number of motor revs.

The acceleration and deceleration of the pump, both at start-up and switch off, is of the soft type.

This helps to reduce water hammer and ensures a quiet operation of the booster set.

Lowara GHV series booster sets guarantee constant pressure of the system as in the following example:

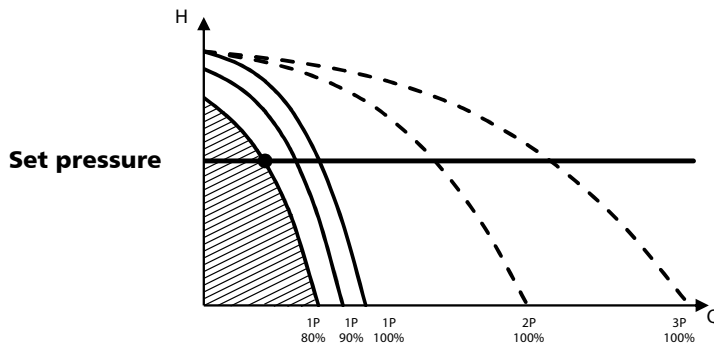

**HYDROVAR® fitted on 0,55 to 22 kW 2 and 4 pole motors (8 units maximum)**

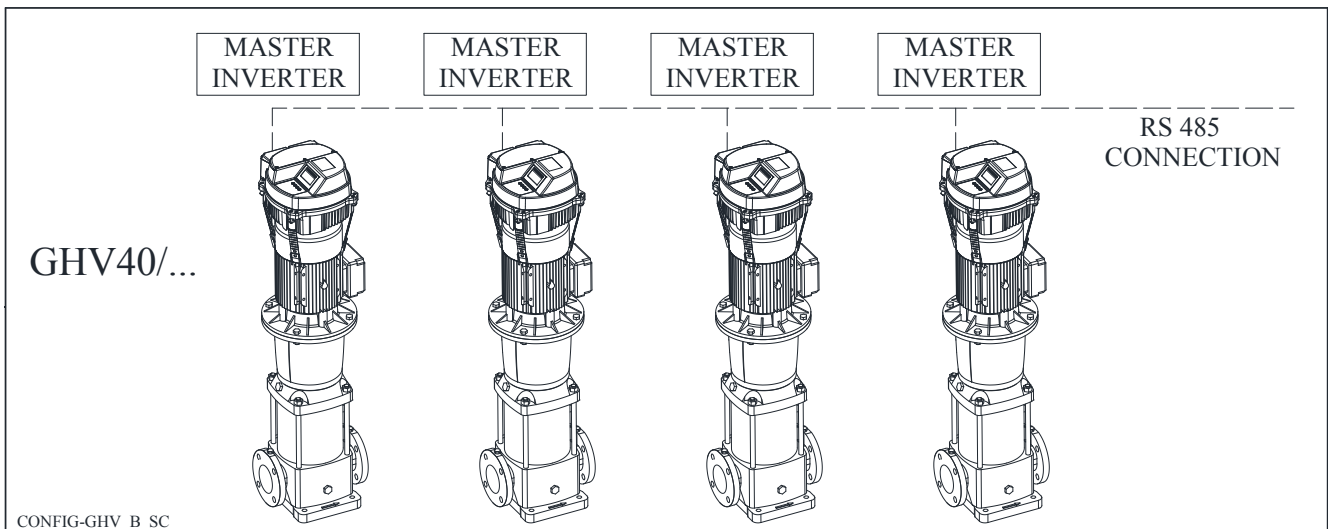

## GHV BOOSTER SETS SERIES DESCRIPTION OF OPERATION

When the pressure decreases, an electric pump starts, adjusting the motor speed so that the set pressure value can be guaranteed. When the demand for water increases, the other pumps also start in sequence, at variable speed, to keep the pressure at a constant level.

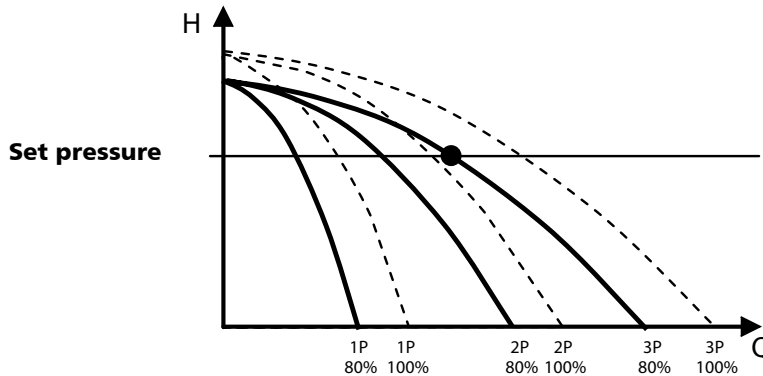

When the demand for water decreases, the pumps switch off in succession. The number of revolutions of the first pump switched on decreases to a set minimum before switching off.

### Regulating the constant pressure value

GHV series booster sets guarantee constant pressure of the system even during frequent variations in water consumption. The system pressure value is measured by the pressure transducers connected to the delivery manifold. The value found is compared with the set value. The comparison between the measured pressure and the set pressure is performed through the HYDROVAR® internal "controller", which manages the motor speed acceleration and deceleration ramps (frequency), changing the performance of the pump during the time. In case of fault of one of the frequency converters, the others will remain active and will continue to guarantee the control of the other pumps and the constant pressure.

### Type of control

GHV series booster sets use one or more sensors as a standard device to control pressure. For each booster set, there are as many sensors as the number of pumps installed. In case of fault of one of the transducer, the converter connected to the pump stops working. It is also possible to change the unit of measure into bar, psi, m<sup>3</sup>/h, °C, °F, l/sec, l/min, %. In this case, different transducers may be used, depending on the selected measure, such as flow or temperature transducers.

### Setpoint

It is possible to set up to two setpoints of different values. In this way, the same booster set can be used for systems that require different pressure values at the utility. For example, different setpoints can be used for an irrigation system on a hillside, or one setpoint value can be used for domestic water supply during the day and a second setpoint for irrigation at night.

The setpoints can be changed through an external consensus.

## **GHV BOOSTER SETS SERIES DESCRIPTION OF OPERATION**

### **Cyclical exchange of pumps**

In the GHV series, pump start is alternated according to a time set for each pump, through a clock in the frequency converter menu.

### **Additional protection against dry running**

Protection against dry running activates when the water reserve falls below the minimum level guaranteed for suction. The level can be checked using a float switch, a minimum pressure switch, an external contact, or level probes. For the latter, the probes must be connected to the adjustable sensitivity electronic module. The control panel is already preset for the installation of this module.

### **Minimum delivery pressure protection**

The minimum delivery pressure function can be managed by entering the pressure value in the menu of the HYDROVAR® control card, which will receive the signal through the pressure transducer at the delivery.



## GHV BOOSTER SETS SERIES ENERGY SAVING

The worldwide demand for energy is growing all the time and, while the demand is increasing, production is coming up against serious problems of an environmental nature and related to the supply of raw materials. In other words, energy is an asset that is becoming more precious every day, imposing choices to optimise consumption, especially with a view to safeguarding the environment.

A very important improvement is provided by new technologies, which together with technical performance, include the safeguard for the environment and energy functionality among the important parameters.

Drives for electric motors fall into this category. As well as making a considerable contribution to the decrease in energy consumption and consequently to the improvement of the environment, in many applications they also produce a notable reduction in the overall costs of running the installations.

### Drives for Electric Motors

The electronic drives that are most involved in the general improvement of the quality of systems and installations, are those for asynchronous alternating current motors, generally three-phase induction motors. They may be divided into two large categories:

- Drives with variable voltage
- Drives with variable frequency

The first, called “starters” or “soft starters”, are appliances that operate at constant frequency (that of the power mains), dose the voltage supplied to the load and have limited current.

The following figure illustrates the typical operation of the “soft starter”:

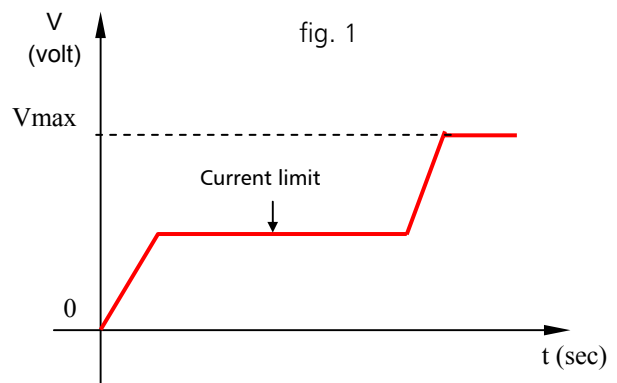

The second, called “Inverters” or “frequency converters” are most important from the point of view of energy saving and are able to supply the motor with a practically sinusoidal current (PMW) at a frequency that may vary from a value of practically 0 Hz to a rated frequency and beyond, with a constant flow (torque) or constant power.

Typical example, fig.2:

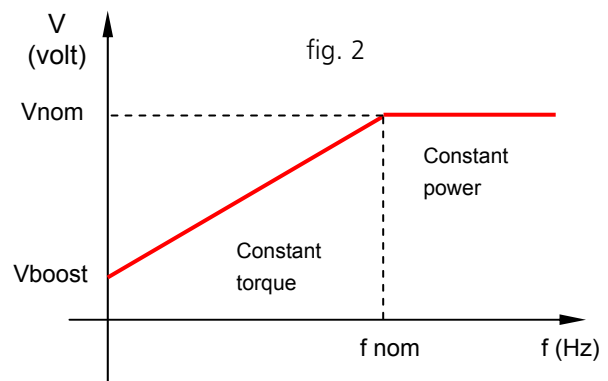

The applicatory advantages of the two categories of drives will be described below.

### Soft start

The direct starting of an asynchronous motor presents considerable difficulties due to the peak current in the start phase. Typically the value of the starting current is about 7/8 times the rated current of the motor. Direct start systems are therefore not generally convenient (except for small power); mainly because of the need to increase the size of the power supply mains (switches, fuses, etc. ...), and also problems of a mechanical nature, due to high stress in the start phase which in the medium/long term may prove to be destructive.

The electrical engineering industry has already found various practical solutions to the problems; the main ones are noted below:

- Special motors with double winding
- Starting with autotransformer
- Star/delta starting

These starting systems are certainly an improvement on direct starting, but they do not solve the problem.

The advent of electronic starters (“soft starters”) made a decisive contribution to solving the question.

## GHV BOOSTER SETS SERIES ENERGY SAVING

This type of drive is able to supply performance advantages:

- Progressive start with a voltage ramp having a duration adjustable within wide time limits.
- Limited current start with a value that can be set from 100% to 500% of the rated value.
- Descending voltage ramp having a duration adjustable within wide time limits.
- Voltage ramps at starting and stopping adaptable to particular operations (pumps).
- Low-speed operation, with reversible running direction, for specific applications.
- "Energy Saving" function with automatic reduction of the voltage/current in the case of a prolonged underload.
- Safety devices that can be calibrated to prevent overheating of the motor, over/under currents and over/under voltages.
- Safety devices that can be calibrated to prevent prolonged or too frequent starts.
- Possibility of by-pass operation after starting, keeping all the safety devices active.

All these features make the electronic starter the ideal tool for solving the problems we have mentioned. With the recently designed starters, with both analog and digital control, it is possible to obtain considerable softer and more efficient starts than any other electromechanical system was able to achieve. Moreover, thanks to the intrinsic control and protection systems of the starter, it is generally possible to eliminate other protection equipment that would otherwise be necessary in the system.

In conclusion, in many applications, one can SAVE on:

- Structure and auxiliary equipment of the power supply system.
- Protection of the mechanical system against excessive stress.

### Speed Adjustment

The speed adjustment systems allow energy consumption in proportion to the use of the system based on user demand. This allows considerable savings in systems working on a daily basis (24h).

Alongside applications that require operation of the electric motors at a constant speed, with steady voltage and frequency, there are many in which the electric motor must be able to vary its speed of rotation (frequency); moreover, in many applications the process control obtained by varying the speed (adjustment of flow rate, pressure, etc...) is much more convenient than any other method of adjustment.

For these applications the most suitable drives are certainly frequency converters, referred to below as "Inverters", which can supply the motor with the desired torque from a few rpm up to the rated speed beyond which they are still able to operate at constant power with a decreasing torque. The advantage of using the Inverter lies in the greater efficiency of the performance that it is able to give in comparison with electromechanical controls.

A useful application of frequency converters may simply be that of obtaining a soft start for a load that is particularly heavy to start (pump) and variable over time (flow rate). In any case the advantage of a soft start is present in all inverter-controlled systems for starting a motor, even in cases where speed adjustment is not needed.

The advantage is due to the fact that the inverter is able to supply the rated torque (with possibility of 150% overload with respect to the rated current), right from frequency zero. This is possible because the voltage to the motor, generated by the inverter, is in phase with the number of revolutions right from the start (unless the motor is running). In this way the losses in the motor are considerably reduced.

The starting torque that can be obtained using the inverter is greater than that obtained with a soft starter, and the demand for current in the whole starting phase is much lower.

The yearly saving, for a lost power of 40000 Kwh, with electromechanical start, may be as much as 2000 Euro.

The reliability and efficiency of the pump speed control systems means optimising consumption and processes as well as savings. In the specific case of pumping appliances, the immediate consequence of the use of these systems is the realisation of pumps with greater operative flexibility, with much larger and optimal performance curves. There are many advantages. Above all, a pump that always works, irrespective of variations in the installation, in optimal conditions, with less wear and less malfunctions. So there are less problems from downtime and the pumps require less frequent maintenance. Moreover, an installation where the pumps are controlled by an inverter is more efficient and less subject to stress:

- absence of water hammer (which occurs when switching off pumps driven in a traditional way);
- lower working pressures than systems with an autoclave or piezometric tank;
- pressure and flow rate conditions always adequate for the demands, because the inverter is able to adjust the pump gradually in real time according to the pressure trend in the installation.

## GHV BOOSTER SETS SERIES ENERGY SAVING

All this results in less stress on all the components in the distribution network, and therefore in less maintenance of the network, greater reliability of supply and lower running costs.

In short, using a pumping system with one or more variable-speed pumps means:

- ✓ Saving energy
- ✓ Optimising resources and processes
- ✓ Having the possibility of complete integration of the management, control and supervision systems
- ✓ Prolonging the life of the installations
- ✓ Reducing maintenance costs
- ✓ Increasing the productivity and yield of an installation

Below is a comparison of the different starting systems:

having examined the various starting systems that can be realised for electric motors, direct start, star/delta, soft starter and inverter, they can be compared, analysing the absorbed currents ( $I_n$ ) and therefore the energy consumed (current = energy = kWh = MONEY)

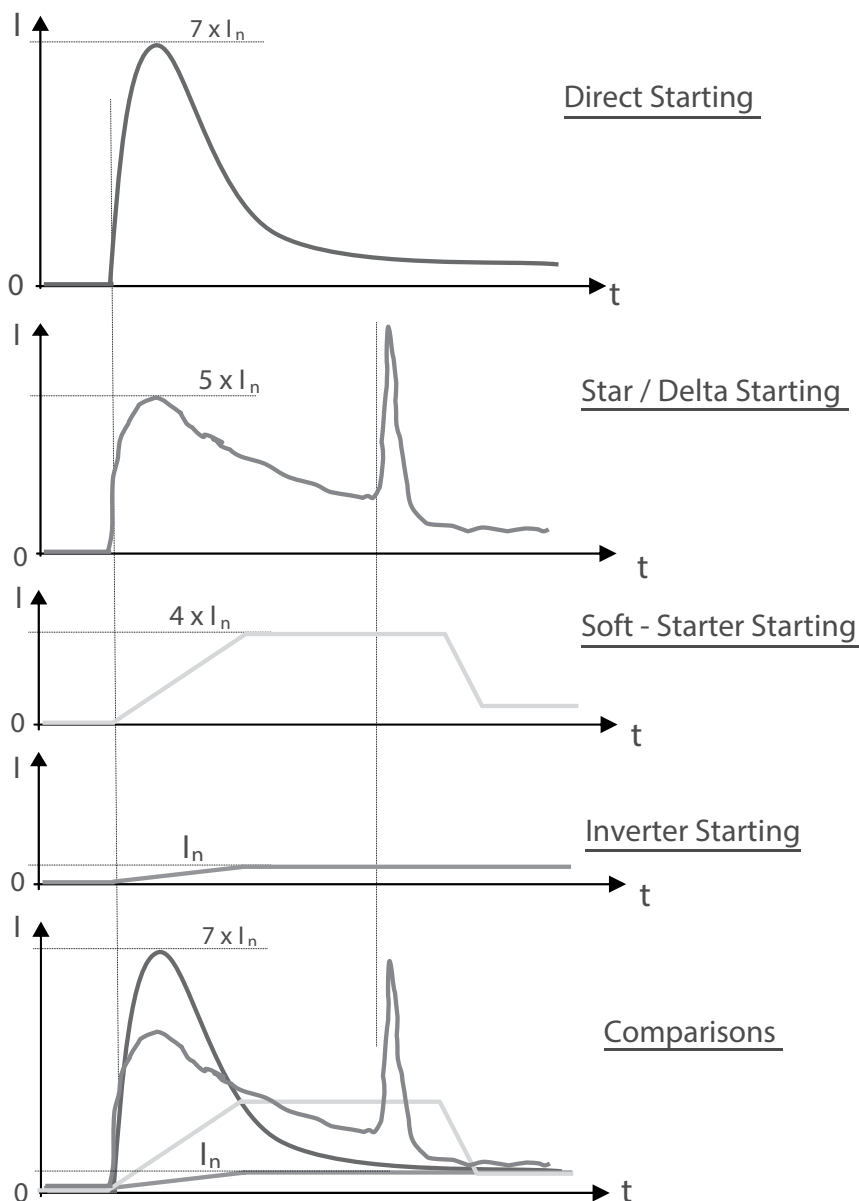

**GHV BOOSTER SETS SERIES  
INSTALLATION**

The booster sets must be installed in areas protected against frost and with adequate ventilation to cool the motors. It is good practice to connect the suction and delivery pipes with vibration-damping joints to limit vibrations and resonance in the whole system.

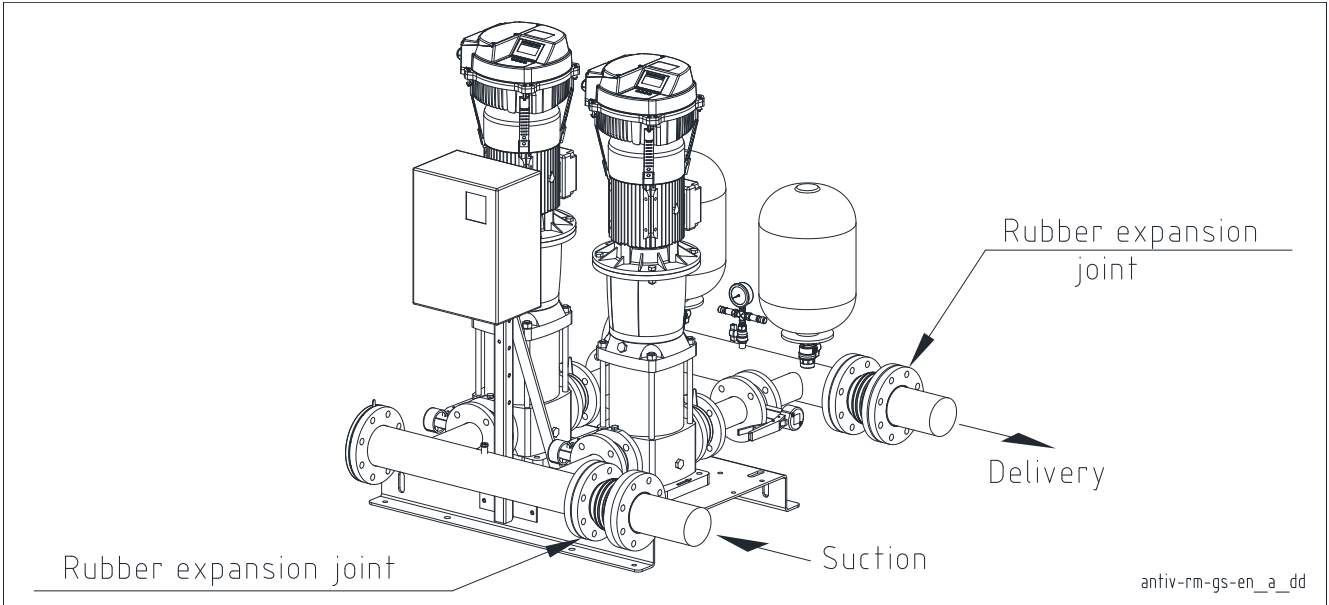

The booster sets must be connected to pressurised tanks with an adequate capacity for the system to be made. These tanks can avoid any problems due to water hammer that is created due to the sudden stopping of the pumps running at a fixed speed. For this type of system, it is possible to use diaphragm tanks (hydro tube) that when installed in the delivery piping perform a pressure dampening function, as they are not intended to store water like autoclave systems. Due to their design, variable-speed booster sets can satisfy users' demands by moderating the pump speed. It is always recommended to check the type of system to be made and choose the correct capacity of the diaphragm tank accordingly.

For the sizing of the diaphragm tanks, see the specific chapter in this catalogue.

Considering also that variable-pressure sets are very sensitive to swings of pressure in the system, the use of diaphragm tanks allows the pressure to stabilise when requests are low or inexistent, and avoids the pumps remaining in operation at minimum speed without stopping.

It is good practice to check the value of the maximum pump pressure to match the set with a tank suitable for the pressure value.

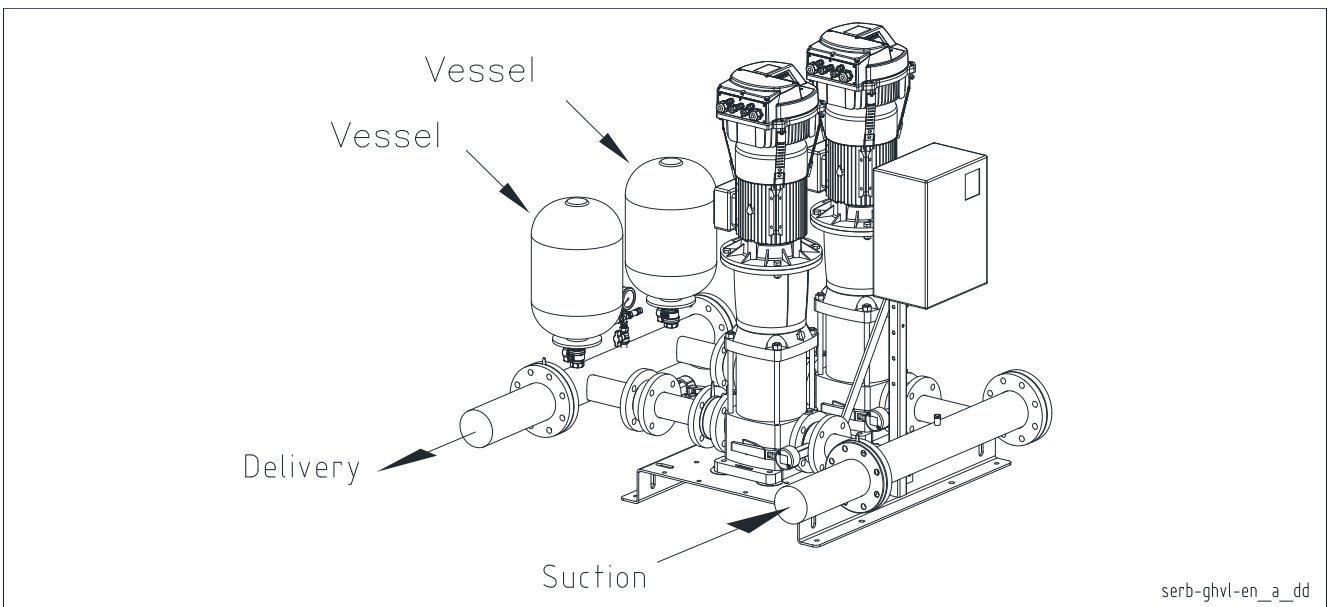

## GHV BOOSTER SETS SERIES CHOICE AND SELECTION

The following conditions should be considered when choosing a variable pressure set:

- The system’s requirements should be met regarding flow rate and pressure.
- The unit must not be oversized, avoiding unnecessary installation and running costs.

Generally water distribution systems such as those for domestic water supply or for large agglomerates such as hospitals, hotels or similar, have “variable” water consumption i.e. in a 24-hour period there may be sudden variations in consumption that are difficult to foresee.

A pattern of consumption may occur in 24 hours, but the daily percentage of unit operation may also occur at various flow rates.

Generally the definition of flow rate for these types of systems is based on either the “probability calculation” which is a very complex system of calculation, or based on tables or diagrams in the national standards which provide guidelines for the sizing of the systems and therefore for calculating the maximum simultaneous flow rate.

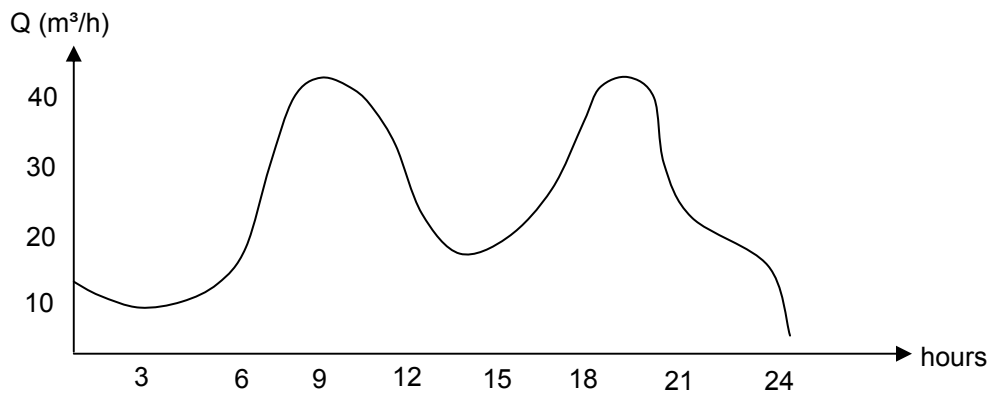

Consumption over 24 h

The operating time of the unit still calculated over 24h, gives us a view of the daily percentage of operation at the various flow rates.

This means that there may be daily peaks where the maximum flow rate requested is concentrated in a short space of time. In the example given below, it can be seen that in 100% of the time there is a consumption of 4 m³/h, while in 20% of the operating time there is a consumption of 40 m³/h.

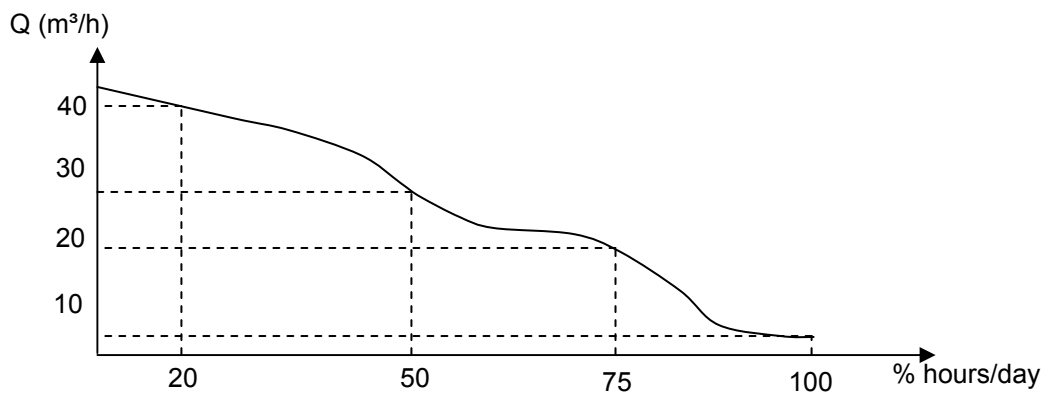

Operating time

## **GHV BOOSTER SETS SERIES CHOICE AND SELECTION**

When selecting the booster set the consumption figure of the system must be considered, which is generally supplied by the person who designed the system.

For systems where consumption varies continuously and suddenly over time it is advisable to install GHV series booster sets with variable regulation of the pump speed.

The calculation of the size of the booster set (its performance and the number of pumps) is based on the take-off point and therefore on the consumption value which takes the following factors into account:

- The value of the peak in consumption
- Efficiency
- NPSH
- Standby pumps
- Jockey pumps
- Diaphragm tanks

By adjusting their operation over time, variable-speed booster sets give the end user energy savings which can be calculated directly on the control board with a metering module fitted in the electric control panel.

This allows checking of the system yield, especially in complex systems with many users and many ranges of consumption.

It is possible to install a standby pump if it is necessary to have some kind of additional safety in the pump station.

This is typical in systems of a certain importance, such as hospitals or factories, or in the field of crop irrigation.

If small users have to be served in the same system, it is preferable to install what is commonly called a jockey pump, where instead of running the main pump, which usually has higher power, the service is guaranteed with a smaller pump and therefore lower energy consumption.

GHV series booster sets must also be equipped with diaphragm tanks (for the size of the tank, see the specific chapter in this catalogue).

A single tank or several smaller tanks can be installed on the delivery of the booster set, always taking the total capacity into account.

Diaphragm tanks avoid the risk of water hammer, which is harmful for both the system and the pumps.

Generally for systems with highly variable or sudden variations in consumption, it is recommended to install a booster set with variable pump speed, such as the GHV series, to guarantee constant pressure.

## GHV BOOSTER SETS SERIES SELECTING THE PUMPS

What type of pump to choose?

Generally, the selection of pump is based on the maximum duty point of the system, which is usually the highest possible. The maximum request value is normally for short periods, so the pump must also be able to satisfy variable requests throughout its time in service.

Generally the choice of the pump, based on the performance curve, should fall around the maximum efficiency point. The pump must ensure operation within its rated performance. Since the unit is sized according to the maximum possible consumption, the maximum duty point of the pumps must be in the area on the right of the performance curve so that, if there is a fall in consumption, the efficiency remains high.

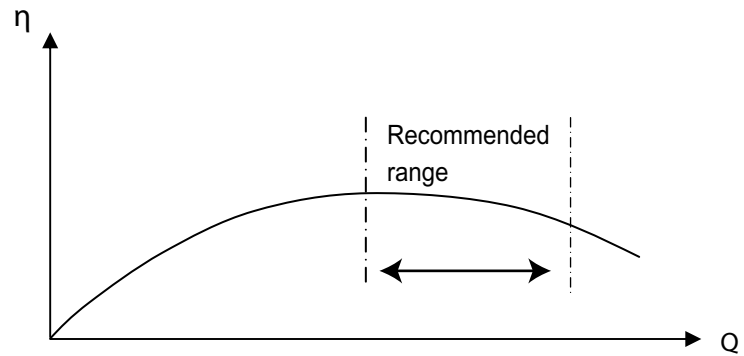

Pump performance curve

If we make a choice on the characteristic curve of the pump, we can see that the area where it is best to select the pump is represented by the following graph:

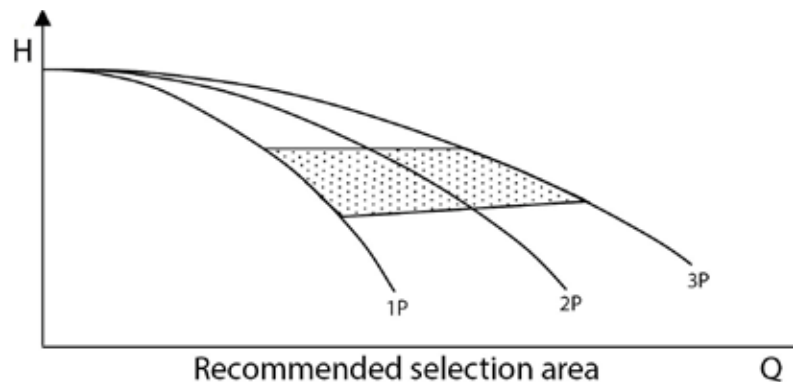

Another factor to be considered when choosing the pumps is its NPSH value. Never choose a pump where the maximum duty point is too far to the right of the NPSH curve. This risks not having good pump suction, which may be aggravated by the type of installation (where negative suction is possible). In these cases there is the risk of cavitation. The NPSH of the pump must always be checked at the maximum flow rate requested.

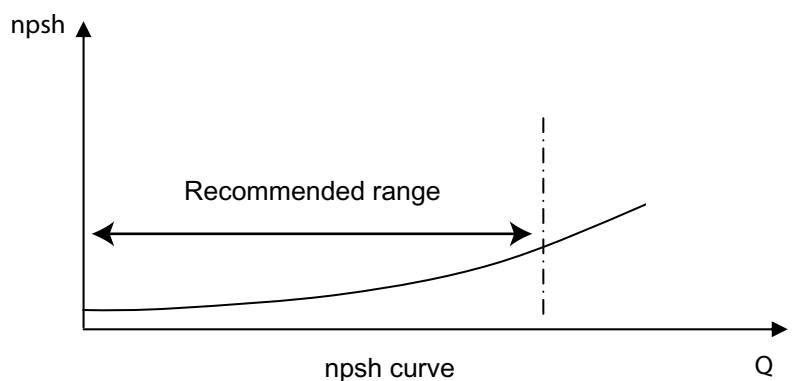

**GHV BOOSTER SETS SERIES  
SELECTING THE PUMPS**

The choice of pump is therefore based on the characteristic curve of the pump depending on the flow rate and the pressure required for the system. Starting from the required flow rate, a vertical line is drawn until it meets the horizontal line of the required pressure. The point of intersection of the lines gives both the type and the number of pumps necessary for the system.

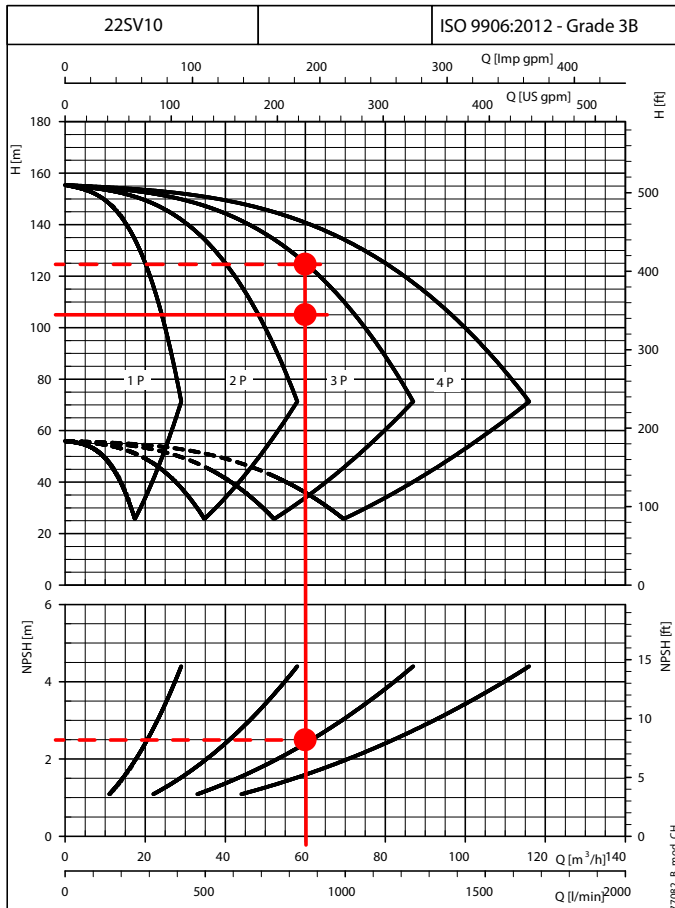

The example alongside refers to a required flow rate of 60 m<sup>3</sup>/h and a pressure of 105 m water column

As shown in the operating curves on page 85, the selection requires three 22SV10 pumps.

Moreover the take-off point falls in the npsh area farthest to the left and therefore in an area with a low cavitation risk.

The values obtained are those for the performance of the pumps. A correct check of the net pressure value must be made due to the intrinsic load loss of the booster set and the conditions of installation. For this reason it is recommended to see the specific chapter in this catalogue.

**NPSH**

The minimum operating values that can be reached by the pump suction are limited by the appearance of cavitation. Cavitation consists in the formation of steam pockets in the liquid when the local pressure reaches a critical value. A critical value is when the local pressure is equal or just below the pressure of the liquid steam. Steam cavitation flows with the current. When it reaches a higher pressure area, condensation of the contained steam occurs. The pockets collide, causing pressure waves that are transmitted to the walls, which are therefore subjected to stress cycles that can cause deformation and then breaks due to fatigue.

This phenomena, characterised by a metallic noise due to the hammering of the walls, is called incipient cavitation. Cavitation damage can be made worse by electrochemical corrosion, and by local temperature increases due to the plastic deformation of the walls. The materials with the highest resistance to heat and corrosion are alloyed steels, and particularly austenitic steels. The conditions that cause cavitation can be predicted by calculating the total suction height, indicated in the technical literature with the acronym NPSH (Net Positive Suction Head).

The NPSH represents the total energy (in m) of the flow measured at the suction in incipient cavitation conditions, net of the steam pressure (in m) of the fluid at the input of the pump.



## GHV BOOSTER SETS SERIES SUCTION CONDITIONS

Once the type and the number of pumps of the set have been identified, the suction conditions must also be assessed. Below is an example of the assessment of the suction lift installation conditions, in relation to the previously described case:

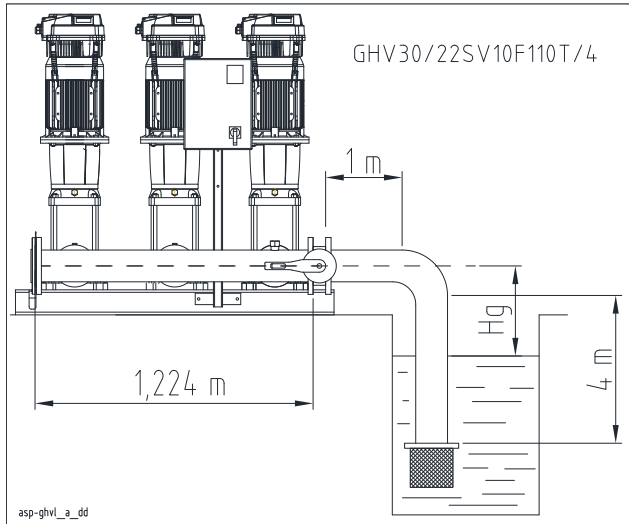

in suction lift installation, it is necessary to calculate the maximum Hg height - which must not be exceeded due to safety reasons -, to avoid cavitation, and therefore the unpriming of the pump itself. The relation that must be assessed, and which connects this value, is the following:

$NPSH_{available} \geq NPSH_{required}$ , when the equality condition represents the limit condition.

$$NPSH_{available} = Patm + Hg - \sum t - \sum a$$

Where:

$Patm$  is the atmospheric pressure, equal to 10,33 m

$Hg$  is the geodetic level difference

$\sum t$  are the pressure drops for suction components such as foot check valve, suction piping, curve, gate valve.

$\sum a$  are the pressure drops for suction set branch.

$l'NPSH_{requested}$  is a parameter obtained from the performance curve; in our case, at the flow of each pump equal to 20 m<sup>3</sup>/h, it corresponds to 2.5 m (page 85). Before calculating the  $l'NPSH_{available}$ , it is necessary to calculate the pressure drops at the suction, using the tables on page 115-116, and taking into account the material, such as the type of stainless steel for the piping and cast iron for the valves. The total sum of the pressure drops  $\sum t$  for suction components is made in the following way, considering that the diameter of the suction piping is DN100, equal to the diameter of the suction manifold of the set (page 59).

Calculation of suction drops  $\sum c$  for cast iron components

Equivalent piping length for DN100 foot check valve = 4,7 m

Equivalent piping length for DN100 gate valve = 0,4 m

Total equivalent length = 4,7 + 0,4 = 5,1 m

Pressure drops in the suction piping (cast iron)  $\sum c = 5,1 \times 7,79 / 100 = 0,39$  m

Calculation of suction drops  $\sum s$  for stainless steel components

Equivalent piping length for DN100 90° curve = 2,1 m

Total equivalent length = 2,1 m

Horizontal suction pipe length = 1 m

Vertical suction pipe length = 4 m

Pressure drops in the suction piping (stainless steel)  $\sum s = (2,1 + 4 + 1) \times 7,79 \times 0,54 / 100 = 0,29$  m

Pressure drops for suction components  $\sum t = \sum c + \sum s = 0,39 + 0,29 = 0,68$  m

The total sum of the pressure drops  $\sum t$  for suction components is made in the following way, considering that the diameter of the suction piping is DN100, equal to the diameter of the suction manifold of the set (page 59).

$H_c$  pressure drops for suction set branch must be assessed on the B curve (pag.100, scheme B0401\_A\_CH); at the flow value of each pump equal to 20 m<sup>3</sup>/h, a value of  $H_c = 2,7$  m is obtained

Calculation of suction drops  $\sum s$  for stainless steel components

Equivalent piping length for DN100 manifold T fitting = 4,3 m

Suction manifold length = 1,224 m

Pressure drops in the suction manifold (steel)  $\sum t = (4,3 + 1,224) \times 7,79 \times 0,54 / 100 = 0,23$  m

Pressure drops  $\sum a = H_c + \sum s = 2,7 + 0,23 = 2,93$  m

Remembering that  $NPSH_{available} = Patm + Hg - \sum t - \sum a$  and that  $NPSH_{available} \geq NPSH_{requested}$  we have that

$Patm + Hg - \sum t - \sum a$  must be  $\geq NPSH_{requested}$ .

Substituting the values we get that  $10,33 + Hg - 0,68 - 2,93 \geq 2,5$  m ( $NPSH_{requested}$ ),

$Hg = 2,5 + 0,68 + 2,93 - 10,33 = -4,9$  m, it represents the limit condition for which

**$NPSH_{available} = NPSH_{requested}$**

Therefore, in order to guarantee the conditions for the correct operation of the system as far as cavitation risks, it will be necessary to position the pump above the water level, so that the Hg height is below the limit value of 4,9 m

## GHV BOOSTER SETS SERIES NET PRESSURE CALCULATION

When selecting GHV booster sets, the performance levels of the pump must be taken into account. Performance levels are obtained from the characteristic curves of the pumps, and do not take into account any pressure drops due to system piping and valves. The following example helps the customer to obtain the correct delivery manifold pressure value: by knowing the system operating point  $Q = 60 \text{ m}^3/\text{h}$  and  $H = 105 \text{ mca}$  ( $P_{\text{requested}}$ ), and the installation height  $H_g$  (estimated to 5 m), in order to make the calculations easier we use the pressure drop curves for each single pump on page 100 of this catalogue.

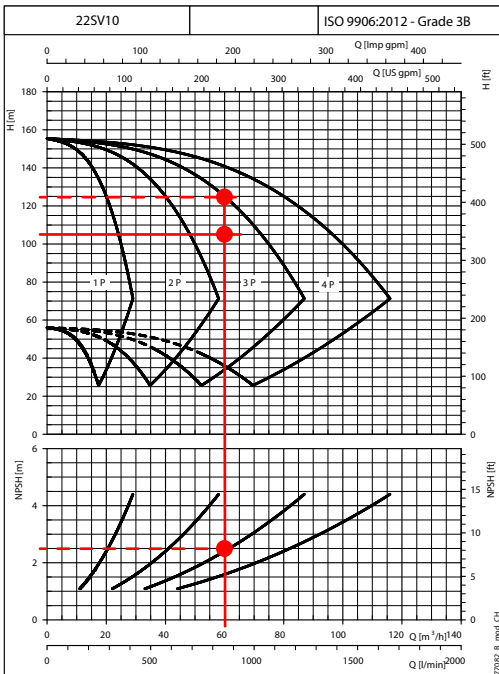

Assuming that a booster set GHV30/22SV with non-return valves on the delivery has been selected, we proceed as follows:

$P_{\text{net available}} \geq P_{\text{requested}}$ , when the equality condition represents the limit condition.

$$P_{\text{net available}} = H - (H_g + \sum t + \sum a + \sum m)$$

Where:

H head value of booster set

$H_g$  is the geodetic level difference (estimated to 5 m)

$\sum t$  are the pressure drops for suction components such as foot check valve, suction piping, curve and gate valve.

$\sum a$  are the pressure drops for suction set branch

$\sum m$  are the pressure drops for delivery set branch

The total sum of the pressure drops  $\sum t$  for suction components is made in the following way, considering that the diameter of the suction piping is DN100, equal to the diameter of the suction manifold of the set (page 59).

Calculation of suction drops  $\sum c$  for cast iron components

Equivalent piping length for DN100 foot check valve = 4,7 m

Equivalent piping length for DN100 gate valve = 0,4 m

Total equivalent length = 4,7 + 0,4 = 5,1 m

Pressure drops in the suction piping (cast iron)

$$\sum c = 5,1 \times 7,79 / 100 = 0,39 \text{ m}$$

Calculation of suction drops  $\sum s$  for stainless steel components

Equivalent piping length for DN100 90° curve = 2,1 m

Total equivalent length = 2,1 m

Horizontal suction pipe length = 1 m

Vertical suction pipe length = 4 m

$$\text{Pressure drops in the suction piping (stainless steel)} \sum s = (2,1 + 4 + 1) \times 7,79 \times 0,54 / 100 = 0,29 \text{ m}$$

Pressure drops for suction components  $\sum t = \sum c + \sum s = 0,39 + 0,29 = 0,68 \text{ m}$

The total sum of the pressure drops  $\sum t$  for suction components is made in the following way, considering that the diameter of the suction piping is DN100, equal to the diameter of the suction manifold of the set (page 59).

$H_c$  pressure drops for suction set branch must be assessed on the B curve (pag.100, scheme B0401\_A\_CH);

at the flow value of each pump equal to 20 m<sup>3</sup>/h, a value of  $H_c = 2,7 \text{ m}$  is obtained

Calculation of suction drops  $\sum s$  for stainless steel components

Equivalent piping length for DN100 manifold T fitting = 4,3 m

Suction manifold length = 1,224 m

$$\text{Pressure drops in the suction manifold (steel)} \sum t = (4,3 + 1,224) \times 7,79 \times 0,54 / 100 = 0,23 \text{ m}$$

$$\text{Pressure drops } \sum a = H_c + \sum s = 2,7 + 0,23 = 2,93 \text{ m}$$

The total sum of the pressure drops  $\sum m$  for delivery branch is made in the following way, considering that the diameter of the delivery manifold is DN100, equal to the diameter of the delivery manifold of the set (page 59).

$H_c$  pressure drops for delivery set branch must be assessed on the A curve (pag.100 scheme B0401\_A\_CH);

at the flow value of each pump equal to 20 m<sup>3</sup>/h, a value of  $H_c = 0,0034 \text{ m}$  is obtained

Calculation of delivery drops  $\sum s$  for stainless steel components

Equivalent piping length for DN100 manifold TEE fitting = 4,3 m

Delivery manifold length = 1,224 m

$$\text{Pressure drops in the delivery manifold (steel)} \sum s = (4,3 + 1,224) \times 7,79 \times 0,54 / 100 = 0,23 \text{ m}$$

$$\text{Pressure drops in delivery manifold } \sum m = H_c + \sum s = 0,0034 + 0,23 = 0,2334 \text{ m}$$

If we analyse the performance of the set at the flow value of 60 m<sup>3</sup>/h, the head value H is 125 m.

The net pressure at the delivery manifold will be  $P_{\text{net available}} = H - (H_g + \sum t + \sum a + \sum m)$

$$\text{Substituting the values we get that } P_{\text{net available}} = 125 - (5 + 0,68 + 2,93 + 0,2334) = 123,84 \text{ m}$$

When comparing this value with the design value (not taking into account the dynamic energy)

we see that  $123,84 \text{ m} > 105 \text{ m}$  [ $P_{\text{net available}} > P_{\text{Required}}$ ]

**The set is therefore capable of meeting system requirements.**

## GHV.../SV Series

Variable speed booster sets  
with HYDROVAR® (HVL series)  
e-SV™ series multistage vertical electric pumps  
with high efficiency motors  
Flow rates up to 640 m<sup>3</sup>/h and pressures up to 16 bar

**50 Hz**

## BOOSTER SET IDENTIFICATION CODE

GHV.../SV

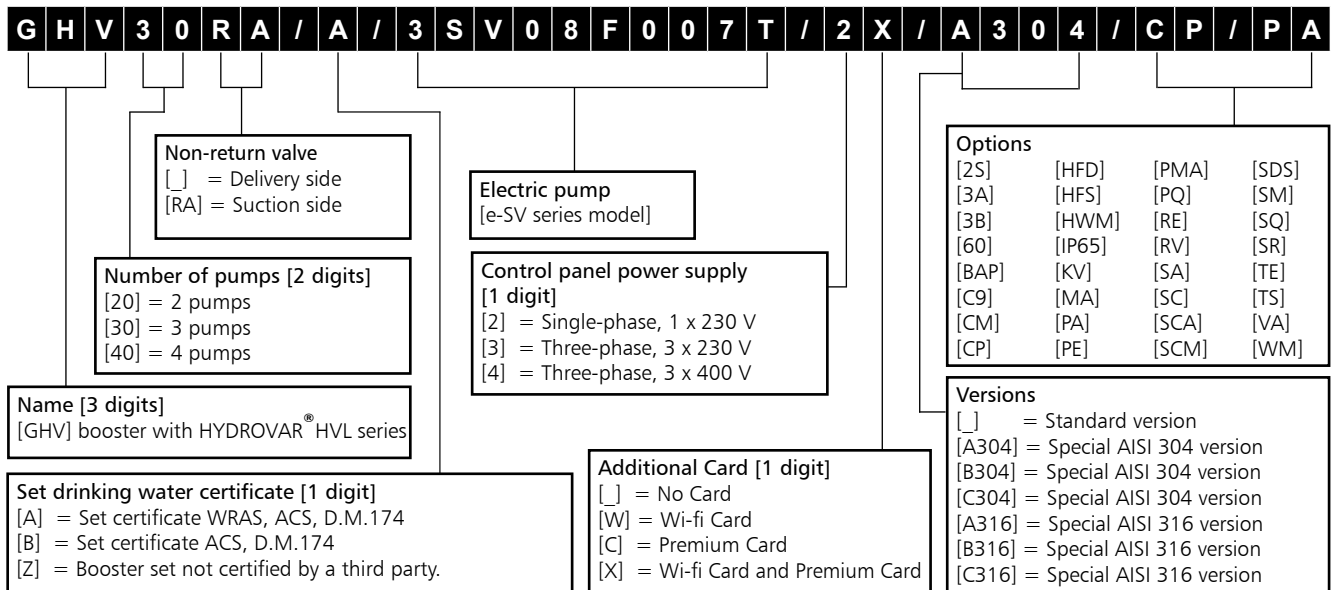

### VERSIONS AVAILABLE

- A304 Main components in contact with the liquid in AISI 304 stainless steel or higher. Galvanised screws and bolts. Flanges not in contact with the liquid galvanised (Available in the Z version).
- B304 Main components in contact with the liquid in AISI 304 stainless steel or higher. Screws and bolts in AISI 304 stainless steel or higher. Flanges not in contact with the liquid in AISI 304 stainless steel (Available in the Z version).
- C304 Main components in contact with the liquid in AISI 304 stainless steel or higher. Base, brackets, supports, screws and bolts in AISI 304 stainless steel or higher. Flanges not in contact with the liquid in AISI 304 stainless steel or higher. Valves fully made of AISI 304 stainless steel or higher (body, heads, disc) (Available in the Z version).
- A316 Main components in contact with the liquid in AISI 316 stainless steel or higher. Galvanised screws and bolts. Flanges not in contact with the liquid galvanised (Available in the Z version).
- B316 Main components in contact with the liquid in AISI 316 stainless steel. Screws and bolts in AISI 316 stainless steel. Flanges not in contact with the liquid in AISI 316 stainless steel (Available in the Z version).
- C316 Main components in contact with the liquid in AISI 316 stainless steel. Base, brackets, supports, screws and bolts in AISI 316 stainless steel. Flanges not in contact with the liquid in AISI 316 stainless steel. Valves fully made of AISI 316 stainless steel (body, heads, disc) (Available in the Z version).

### OPTIONS

- 2S HYDROVAR® equipped with double sensor for each pump, one in stand-by (both in delivery side)
- 3A Set with 1A certified pumps (Factory test report issued from end of line, QH curve included).
- 3B Set with 1B certified pumps (Test bulletin issued by Sala Audit (Audit Room); it includes QH curve, output and power).
- 60 Set operating frequency 60 Hz, electric pumps with 60Hz motor. Maximum HYDROVAR® output frequency set at 60Hz.
- BAP High pressure switch on the delivery manifold.
- C9 Delivery manifold turned by 90°, curves. It is not possible to install expansion vessels directly on the manifold.
- CM Suction or delivery manifold larger than standard size.
- CP Control panel with clean contacts: converter faulty, operation/stop for each pump.
- HFD HYDROVAR® and control panel mounted on bracket on the delivery side, fastened to the base of the set.
- HFS HYDROVAR® and control panel mounted on bracket on the suction z, fastened to the base of the set.
- HWM HYDROVAR® wall mounted version, motor cable length 5m.
- IP65 IP65 protection degree control panel.
- MA Pressure gauge installed on the suction manifold.
- PA Minimum pressure pressure switch on the suction manifold, for protection against dry running.
- PE Control panel with emergency button.
- PMA Minimum pressure pressure switch and vacuum pressure gauge for protection against dry running, installed on the suction manifold.
- PQ Set for aqueduct installation (with pressure gauge/ pressure switches/transmitters oversized by one size).
- RE Control panel with condensation resistance, controlled by a thermostat.
- RV Control panel with phase missing, phase asymmetry, and minimum and maximum voltage value control.
- SA Without suction: without suction valves and without suction manifold.
- SC Set without control devices such as pressure switches and transmitters; with pressure gauge.
- SCA Without suction manifold (but with suction valves).
- SCM Without delivery manifold (without pressure switches, transmitters and pressure gauge; with delivery valves).
- SDS HYDROVAR® equipped with 1 sensor in suction side and 1 in delivery side
- SM Without delivery: without delivery valves and without delivery manifold.
- SQ Booster set without control panel and bracket; with pressure transmitters and HYDROVAR® units.
- SR Without non-return valve.
- TE Control panel with timer, for booster set change after the set time (1 minute).
- TS Set with electric pumps with special seals.
- VA Control panel with digital voltmeter and ammeter.
- WM Wall mounted control panel; cables L=5m.

## RANGE

The standard range of GHV series variable-speed booster sets includes models with 2 to 4 pumps in different configurations, to adapt to the specific needs of each application.

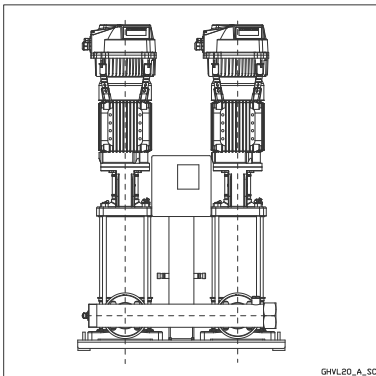

### GHV20 SERIES

- Variable speed sets with HYDROVAR frequency converter and two multistage vertical pumps with power up to 22 kW.

**Head** up to 160 m.  
**Flow rate** up to 320 m<sup>3</sup>/h.

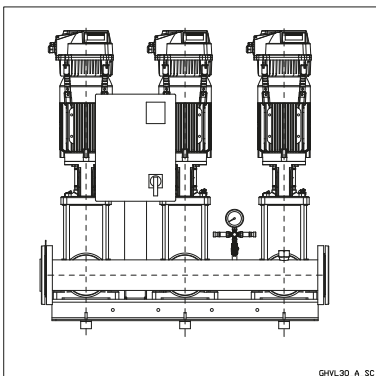

### GHV30 SERIES

- Variable speed sets with HYDROVAR frequency converter and three multistage vertical pumps with power up to 22 kW.

**Head** up to 160 m.  
**Flow rate** up to 480 m<sup>3</sup>/h.

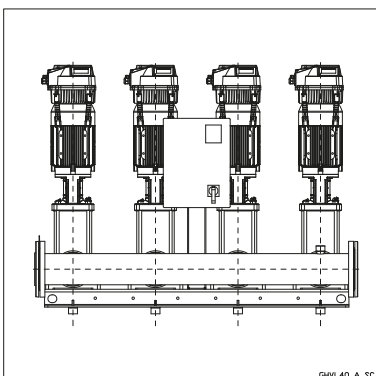

### GHV40 SERIES

- Variable speed sets with HYDROVAR frequency converter and four multistage vertical pumps with power up to 22 kW.

**Head** up to 160 m.  
**Flow rate** up to 640 m<sup>3</sup>/h.

## ELECTRIC PUMPS GENERAL DESCRIPTION

The **e-SV** pump is a multistage vertical pump, not self-priming, combined with a normalised standard motor. The liquid end, located between the upper cover end the pump casing, is held in place by tie rods. The pump casing is available with different configurations and connection types.

GHV.../SV



### Technical Information:

Flow rates: up to 160 m<sup>3</sup>/h.  
Heads: up to 160 m.  
(referred to the pump range used in this catalogue).

Temperature of pumped liquid:  
from -30°C to +120°C (standard version).

Tested to ISO 9906:2012 - Grade 3B  
(ex ISO 9906:1999 - annex A).  
Direction of rotation: clockwise looking at the pump from the top down (indicated with an arrow on the bracket and joint).

Mechanical seal: Silicon carbide/Carbon/EPDM.  
e-SV pumps (only for 10, 15, 22SV ≥ 5,5 kW and 33, 46, 66, 92, 125SV) are fitted standard with a balanced mechanical seal that can be replaced without having to remove the motor from the pump.

Elastomers: EPDM.

### Motor

**Supplied IE3 three-phase surface motors ≥ 0,75 kW as standard.**

Electrical performances according to EN 60034-1.  
Insulation class 155 (F).  
IP55 protection.  
Condensate drain plugs on standard version.  
Cooling by fan according to EN 60034-6.  
Cable gland metric size according to EN 50262.  
Standard supplied e-SV electric pumps are equipped with Standard motors.

Standard voltage:

- **Single-phase version:** 220-240 V 50 Hz.
- **Three-phase version:** 220-240/380-415 V 50 Hz.

For electrical data of the motors used see page 24.

### Materials

The pumps for F, T, R, N, G versions are certified for drinking water use (**WRAS, ACS and D.M.174.**)

**For complete information see dedicated e-SV technical catalogue.**

## ELECTRIC PUMPS 3, 5, 10, 15, 22SV SERIES CHARACTERISTICS

- Multistage centrifugal vertical electric pumps.  
All metal parts in contact with pumped liquid are made of stainless steel.
- **F** version: round flanges, in-line delivery and suction ports, AISI 304 stainless steel.
- Further choice possibilities among the following versions:
  - **T**: oval flanges, in-line delivery and suction ports, AISI 304 stainless steel.
  - **R**: round flanges, delivery port above the suction port and adjustable in four positions, AISI 304 stainless steel.
  - **N**: round flanges, in-line delivery and suction ports, AISI 316 stainless steel.
- Reduced axial thrusts enable the use of **standard motors** that are easily found on the market.
- Standard mechanical seal according to EN 12756 (formerly DIN 24960) and ISO 3069 for series 1, 3, 5SV and 10, 15, 22SV ( $\leq di$  4 kW).
- **Balanced mechanical seal** according to EN 12756 (formerly DIN 24960) and ISO 3069, easy to replace **without removing the pump motor**, for series 10, 15 and 22SV ( $\geq di$  5,5 kW).
- Seal housing designed to avoid air accumulation inside the critical area adjoining the mechanical seal.
- Second loading plug available for series 10, 15, 22SV.
- Easy maintenance. No special tools required for assembly or disassembly.

**F, T, R and N pumps are certified for use with drinking water (WRAS, ACS and D.M.174.)**

## 33, 46, 66, 92, 125SV SERIES CHARACTERISTICS

- Version **G**: Multistage vertical centrifugal electric pump with impellers, diffusers and outer jacket fully made of stainless steel; superior cast iron pump body and head. Round flanges, in-line delivery and suction ports.
- Further choice possibilities among the following versions:
  - **N, P**: fully made of AISI 316 stainless steel.
- In pumps with higher heads, the axial load compensation system allows a reduction of axial thrusts, and therefore the use of **normalised standard motors**, easy to find on the market.
- **Balanced mechanical seal** according to EN 12756 (formerly DIN 24960) and ISO 3069, **easy to replace without removing the pump motor**.
- Seal housing designed to avoid air accumulation inside the critical area adjoining the mechanical seal.
- Pump body supplied with the necessary attachments for a pressure gauge on the flanges, both on the suction and the delivery side.
- Mechanical strength and easy maintenance. No special tools required for assembly or disassembly.

**G and N pumps are certified for use with drinking water (WRAS, ACS and D.M.174.)**

## ELECTRIC PUMPS THREE-PHASE MOTORS AT 50 Hz, 2-POLE (up to 22 kW)

GHV.../SV

P <sub>N</sub> kW	Efficiency η <sub>N</sub> %																		IE	Year of manufacture		
	Δ 220 V Y 380 V			Δ 230 V Y 400 V			Δ 240 V Y 415 V			Δ 380 V Y 660 V			Δ 400 V Y 690 V			Δ 415 V						
	4/4	3/4	2/4	4/4	3/4	2/4	4/4	3/4	2/4	4/4	3/4	2/4	4/4	3/4	2/4	4/4	3/4	2/4				
0,37	-	-	-	-	-	-	-	-	-	-	-	-	-	-	-	-	-	-	-	-	-	-
0,55	-	-	-	-	-	-	-	-	-	-	-	-	-	-	-	-	-	-	-	-	-	-
0,75	82,5	83,1	81,3	82,8	82,7	80,1	82,6	82,0	78,9	82,5	82,0	78,9	82,5	82,0	78,9	82,5	82,0	78,9	-	-	-	-
1,1	84,0	84,7	83,4	84,4	84,5	82,5	84,3	84,0	81,4	84,0	84,0	81,4	84,0	84,0	81,4	84,0	84,0	81,4	-	-	-	-
1,5	85,6	86,5	85,8	85,9	86,4	84,9	86,0	86,0	84,0	85,6	86,0	84,0	85,6	86,0	84,0	85,6	86,0	84,0	-	-	-	-
2,2	86,5	87,4	86,8	86,4	86,9	85,7	86,6	86,7	85,0	86,4	86,7	85,0	86,4	86,7	85,0	86,4	86,7	85,0	-	-	-	-
3	87,2	88,5	88,3	87,5	88,2	87,5	87,5	87,8	86,4	87,2	87,8	86,4	87,2	87,8	86,4	87,2	87,8	86,4	-	-	-	-
4	89,1	90,1	89,2	89,1	90,1	89,2	89,1	90,1	89,2	89,1	90,3	90,4	89,6	90,4	89,9	89,6	90,1	89,2	-	-	-	-
5,5	89,5	89,6	88,0	89,5	89,6	88,0	89,5	89,6	88,0	89,5	90,3	89,9	89,7	90,0	89,0	89,6	89,6	88,0	-	-	-	-
7,5	90,6	90,5	89,0	90,6	90,5	89,0	90,6	90,5	89,0	90,6	91,0	90,2	90,8	90,8	89,6	90,7	90,5	89,0	-	-	-	-
11	91,3	92,0	91,1	91,3	92,0	91,1	91,3	92,0	91,1	91,3	92,2	92,2	91,6	92,2	91,7	91,7	92,0	91,1	-	-	-	-
15	92,5	92,4	91,2	92,5	92,4	91,2	92,5	92,4	91,2	92,7	93,3	92,9	93,1	93,3	92,7	92,5	92,4	91,2	-	-	-	-
18,5	92,6	93,1	92,4	92,6	93,1	92,4	92,6	93,1	92,4	92,6	93,2	93,0	92,9	93,3	92,8	92,9	93,1	92,4	-	-	-	-
22	93,0	92,7	91,3	93,0	92,7	91,3	93,0	92,7	91,3	93,0	93,2	92,4	93,1	93,0	91,9	93,0	92,7	91,3	-	-	-	-

P <sub>N</sub> kW	Manufacturer		IEC SIZE*	Construction Design	N. of Poles	f <sub>N</sub> Hz	Data for 400 V / 50 Hz Voltage				
	Xylem Service Italia Srl Reg. No. 07520560967 Montecchio Maggiore Vicenza - Italia						cosφ	I <sub>s</sub> / I <sub>N</sub>	T <sub>N</sub> Nm	T <sub>s</sub> /T <sub>N</sub>	T <sub>m</sub> /T <sub>n</sub>
	Model										
0,37	SM71RB14/304		71R	V18/B14	2	50	0,64	4,35	1,37	4,14	4,10
0,55	SM71B14/305		71				0,74	5,97	1,85	3,74	3,56
0,75	SM80B14/307 PE		80				0,78	7,38	2,48	3,57	3,75
1,1	SM80B14/311 PE		80				0,79	8,31	3,63	3,95	3,95
1,5	SM90RB14/315 PE		90R				0,80	8,80	4,96	4,31	4,10
2,2	PLM90B14/322 E3		90				0,80	8,77	7,28	3,72	3,70
3	PLM100RB14/330 E3		100R				0,79	7,81	9,93	4,26	3,94
4	PLM112RB14S6/340 E3		112R				0,85	9,13	13,2	3,82	4,32
5,5	PLM132RB5/355 E3		132R				0,85	10,5	18,1	4,74	5,11
7,5	PLM132B5/375 E3		132				0,85	10,2	24,4	3,43	4,76
11	PLM160RB5/3110 E3		160R				0,86	9,89	35,9	3,46	4,59
15	PLM160B5/3150 E3		160				0,88	9,51	48,6	2,73	4,32
18,5	PLM160B5/3185 E3		160				0,88	9,81	59,9	2,81	4,53
22	PLM180RB5/3220 E3		180R				0,85	10,9	71,1	3,26	5,12

P <sub>N</sub> kW	Voltage U <sub>N</sub> V											n <sub>N</sub> min <sup>-1</sup>	Observe the regulations and codes locally in force regarding sorted waste disposal.	Operating conditions **		
	Δ			Y			Δ			Y				Altitude Above Sea Level (m)	T. amb min/max °C	ATEX
	220 V	230 V	240 V	380 V	400 V	415 V	380 V	400 V	415 V	660 V	690 V					
0,37	2,03	2,18	2,32	1,17	1,26	1,34	-	-	-	-	-	2745 ÷ 2800	≤ 1000	-15 / 40	No	
0,55	2,56	2,56	2,62	1,48	1,48	1,51	-	-	-	-	-	2825 ÷ 2850				
0,75	2,96	2,94	2,96	1,71	1,70	1,71	1,70	1,69	1,70	0,98	0,98	2875 ÷ 2895				
1,1	4,19	4,14	4,16	2,42	2,39	2,40	2,41	2,38	2,38	1,39	1,37	2870 ÷ 2900				
1,5	5,56	5,49	5,51	3,21	3,17	3,18	3,21	3,18	3,19	1,85	1,84	2870 ÷ 2895				
2,2	7,97	7,90	7,98	4,6	4,56	4,61	4,57	4,54	4,57	2,64	2,62	2880 ÷ 2900				
3	11,0	11,0	11,2	6,35	6,33	6,44	6,29	6,27	6,34	3,63	3,62	2865 ÷ 2895				
4	13,6	13,4	13,4	7,87	7,75	7,74	7,80	7,62	7,61	4,50	4,40	2885 ÷ 2910				
5,5	18,1	17,9	18,1	10,4	10,4	10,4	10,6	10,5	10,7	6,10	6,05	2880 ÷ 2910				
7,5	24,8	24,4	24,3	14,3	14,1	14,0	14,4	14,1	14,2	8,32	8,16	2920 ÷ 2935				
11	35,7	35,0	34,9	20,6	20,2	20,2	20,6	20,2	20,2	11,9	11,7	2910 ÷ 2930				
15	47,6	46,1	45,2	27,5	26,6	26,1	27,5	26,6	26,1	15,9	15,3	2940 ÷ 2950				
18,5	58,3	56,7	55,6	33,7	32,7	32,1	34,0	33,0	32,7	19,6	19,0	2940 ÷ 2950				
22	72,9	73,1	73,7	42,1	42,2	42,6	40,9	40,4	40,6	23,6	23,3	2950 ÷ 2960				

\* R = Reduced size of motor casing as compared to shaft extension and flange.

\*\* Operating conditions to be referred to motor only. About electric pump, refer to limits in user's manual.

sv-IE3-mott22-2p50-en\_a\_te



## ELECTRIC PUMPS THREE-PHASE MOTORS AT 50 Hz, 2-POLE (from 30 to 55 kW)

P <sub>N</sub> kW	Efficiency $\eta_N$ %									IE	Year of manufacture
	$\Delta$ 380 V Y 660 V			$\Delta$ 400 V Y 690 V			$\Delta$ 415 V				
	4/4	3/4	2/4	4/4	3/4	2/4	4/4	3/4	2/4		
30	94,0	94,0	93,1	94,1	94,0	92,8	94,2	93,9	92,6	3	From 11/2014
37	94,4	94,0	93,5	94,6	94,0	93,3	94,7	93,9	93,1		
45	94,8	94,9	94,6	95,1	95,1	94,6	95,3	95,2	94,5		
55	95,1	95,0	94,9	95,4	95,3	94,9	95,5	95,3	94,8		

P <sub>N</sub> kW	Manufacturer		IEC SIZE	Construction Design	N. of Poles	f <sub>N</sub> Hz	Data for 400 V / 50 Hz Voltage				
	WEG Equipamentos Eletricos S.A. Reg. No. 07.175.725/0010-50 Jaragua do Sul - SC (Brazil)						cos $\phi$	I <sub>s</sub> / I <sub>N</sub>	T <sub>N</sub> Nm	T <sub>s</sub> /T <sub>N</sub>	T <sub>m</sub> /T <sub>N</sub>
	Model										
30	W22 200L V1 30KW E3		200	V1	2	50	0,86	7,30	96,60	2,60	2,90
37	W22 200L V1 37KW E3		200				0,86	7,30	119,2	2,60	2,90
45	W22 225S/M V1 45KW E3		225				0,88	8,00	144,7	2,70	3,20
55	W22 250S/M V1 55KW E3		250				0,89	7,90	177,1	2,80	2,90

P <sub>N</sub> kW	Voltage U <sub>N</sub> V					n <sub>N</sub> min <sup>-1</sup>	See note.	Operating conditions **		
	$\Delta$			Y				Altitude Above Sea Level (m)	T. amb min/max °C	ATEX
	380 V	400 V	415 V	660 V	690 V					
	I <sub>N</sub> (A)									
30	55,1	53,5	52,7	31,7	31,0	2960 ÷ 2970	≤ 1000	-15 / 40	No	
37	67,7	65,6	64,7	39,0	38,0	2960 ÷ 2970				
45	80,1	77,6	74,6	46,1	45,0	2965 ÷ 2970				
55	97,6	93,5	91,0	56,2	54,2	2960 ÷ 2965				

\*\* Operating conditions to be referred to motor only. About electric pump, refer to limits in user's manual.

sv-IE3-mott55-2p50-en\_a\_te

Note: Observe the regulations and codes locally in force regarding sorted waste disposal.

## SOUND EMISSION LEVELS

50 Hz 2900 min <sup>-1</sup>		LpA (dB $\pm$ 2)**		
P2 (kW)	IEC*	GHV20	GHV30	GHV40
1,1	80	< 70	< 70	< 70
1,5	90	< 70	< 70	< 70
2,2	90	< 70	< 70	< 70
3	100R	< 70	< 70	< 70
4	112R	< 70	< 70	< 70
5,5	132R	< 70	< 70	< 70
7,5	132	74	76	77
11	160R	76	78	79
15	160	74	76	77
18,5	160	76	78	79
22	180R	73	75	76
30	200	75	77	78
37	200	75	77	78

\* R=Reduced motor casing size with respect to shaft extension and related flange.

GHVcom\_2p-en\_a\_tr

\*\* Noise value of the electric motor only.

## HYDROVAR HVL GENERAL DESCRIPTION

GHV booster sets use the **HYDROVAR** frequency converter, an automatic device that gives the possibility of changing the **number of electric pump revolutions**, and maintain the system **pressure constant**.

Power converters up to 22 kW are **installed directly on the motor fan cover**. Using the additional **fan kit**, they can also be installed on the wall, or on a bracket attached to the set. 30 or 45 kW models are only suitable for wall or bracket installation.

The basic function of HYDROVAR, is to control the pump based on system requirements.

The basic function of the HYDROVAR device is to control the pump to meet the system demands.

### HYDROVAR performs these functions by:

- 1) Measuring the system pressure or flow via a transmitter mounted on the pump's delivery side.
- 2) Calculating the motor speed to maintain the correct flow or pressure.
- 3) Sending out a signal to the pump to start the motor, increase speed, decrease speed or stop.
- 4) In the case of multiple pump installations, HYDROVAR will automatically provide for the cyclic changeover of the pumps' starting sequence.

In addition to these basic functions, HYDROVAR can perform controls only manageable by the most advanced computerized control systems. Some examples are:

- Stop the pump(s) at zero demand.
- Stop the pump(s) in case of water failure on the suction side (protection against dry running).
- Stop the pump if the required delivery exceeds the pump's capacity (protection against cavitation caused by excessive demand), or automatically switch on the next pump in a multiple series.
- Protect the pump and motor from over-voltage, under-voltage, overload, and earth fault.
- Vary the pump speed: acceleration and deceleration time.
- Compensate for increased flow resistance at high flow rates.
- Conduct automatic tests at set intervals.
- Monitor the converter and motor operating hours.
- Monitor the energy consumption (kWh).
- Display all functions on an LCD in different languages (Italian, English, French, German, Spanish, Portuguese, Dutch, etc...).
- Send a signal to a remote control system which is proportional to the pressure and frequency.
- Communicate with external control system via Modbus (RS 485 interface) and Bacnet as standard.

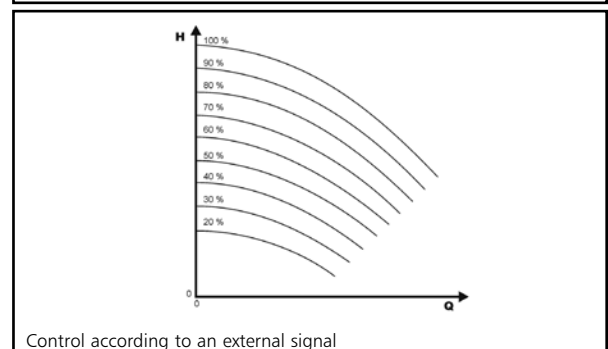
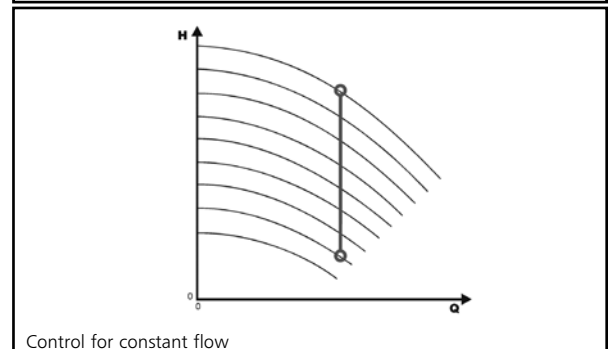
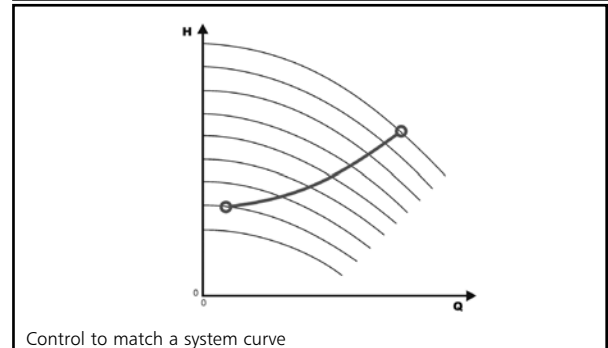
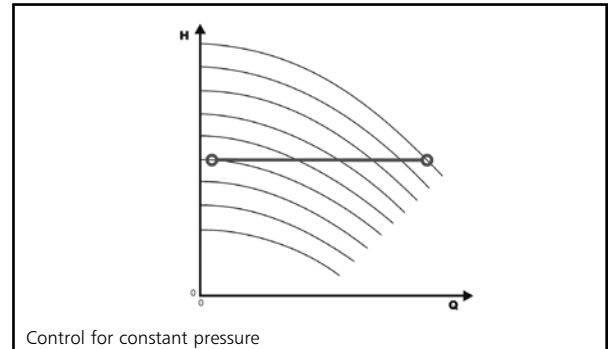

## HYDROVAR HVL IDENTIFICATION CODE

**H V L 4 . 0 7 5 - A 0 0 1 0**

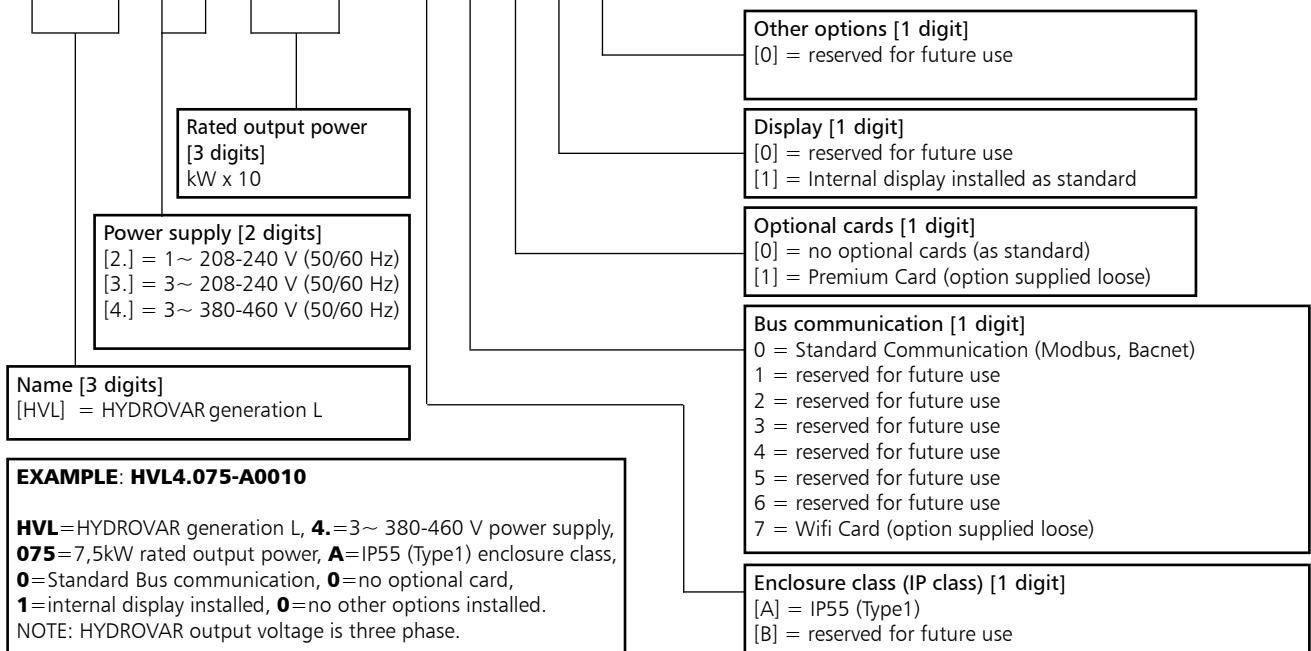

**GHV.../SV**

## DIMENSIONS AND WEIGHTS



TYPE	MODELS			DIMENSIONS (mm)				WEIGHT Kg
	/2	/3	/4	L	B	H	X	
SIZE A	HVL2.015 ÷ 2.022	HVL3.015 ÷ 3.022	HVL4.015 ÷ 4.040	216	205	170	243	5,6
SIZE B	HVL2.030 ÷ 2.040	HVL3.030 ÷ 3.055	HVL4.055 ÷ 4.110	276	265	185	305	10,5
SIZE C	-	HVL3.075 ÷ 3.110	HVL4.150 ÷ 4.220	366	337	200	407	15,6

HVL\_dim-en\_b\_td

## HYDROVAR HVL DISPLAY POSITION

GHV.../SV

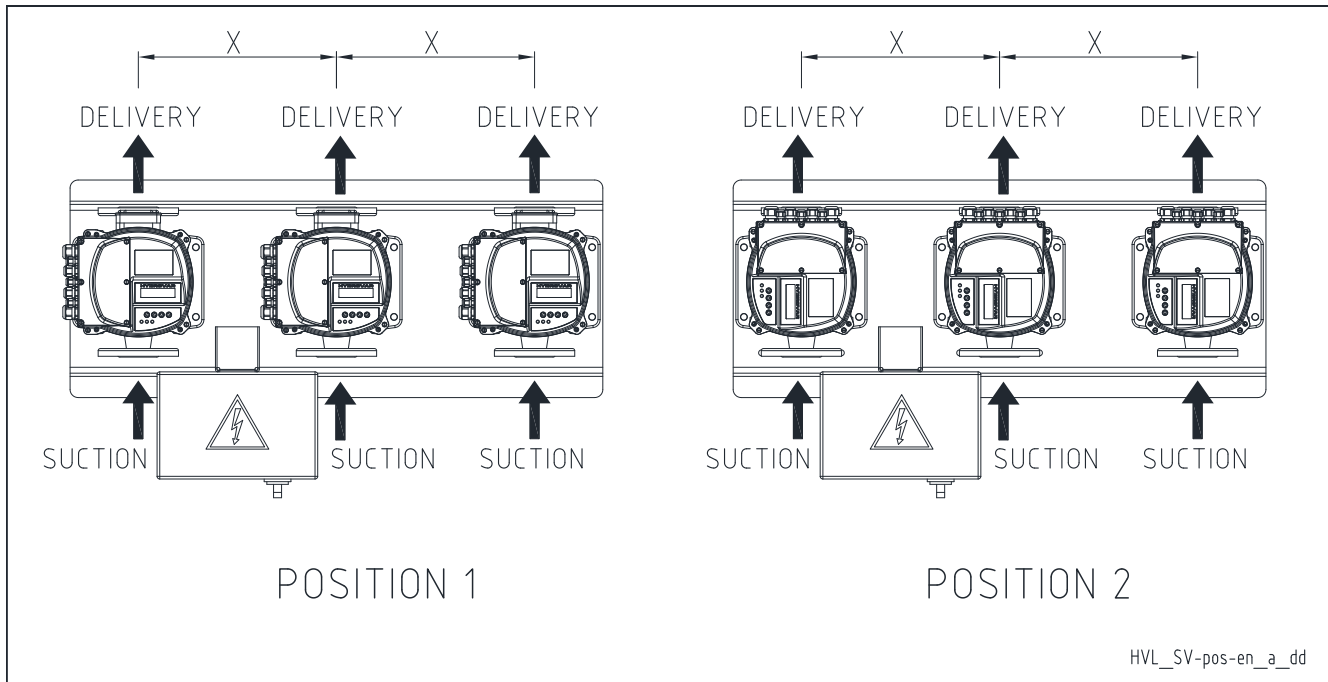

HVL SIZE A	
X (mm)	HVL STD position
300	1
370	1
440	1
490	1

HVL SIZE B	
X (mm)	HVL STD position
300	2
370	2
440	1
490	1
570	1

HVL SIZE C	
X (mm)	HVL STD position
370	2
440	2
490	1
	2 (only 22 kW)
570	1

HVL\_SV-pos-en\_a\_td

## HYDROVAR HVL TECHNICAL DATA

Model (*)	Inverter			Motor	
	Power supply (V)	IP Degree	Installation	Power supply (V)	Power (kW)
HVL 2.015	1x230	IP 55	Motor	3x230	0,55-1,5
HVL 2.022	1x230	IP 55	Motor	3x230	2,2
HVL 2.030	1x230	IP 55	Motor	3x230	3
HVL 2.040	1x230	IP 55	Motor	3x230	4
HVL 4.015	3x400	IP 55	Motor	3x400	0,55-1,5
HVL 4.022	3x400	IP 55	Motor	3x400	2,2
HVL 4.030	3x400	IP 55	Motor	3x400	3
HVL 4.040	3x400	IP 55	Motor	3x400	4
HVL 4.055	3x400	IP 55	Motor	3x400	5,5
HVL 4.075	3x400	IP 55	Motor	3x400	7,5
HVL 4.110	3x400	IP 55	Motor	3x400	11
HVL 4.150	3x400	IP 55	Motor	3x400	15
HVL 4.185	3x400	IP 55	Motor	3x400	18,5
HVL 4.220	3x400	IP 55	Motor	3x400	22
HVL 3.015	3x230	IP 55	Motor	3x230	0,55-1,5
HVL 3.022	3x230	IP 55	Motor	3x230	2,2
HVL 3.030	3x230	IP 55	Motor	3x230	3
HVL 3.040	3x230	IP 55	Motor	3x230	4
HVL 3.055	3x230	IP 55	Motor	3x230	5,5
HVL 3.075	3x230	IP 55	Motor	3x230	7,5
HVL 3.110	3x230	IP 55	Motor	3x230	11

GHV with Hydrovar HVL 3 available on request

ghvl-2p-en\_a\_td

## HYDROVAR HVL EMC COMPATIBILITY

### EMC requirements

HYDROVAR fulfills the product standard EN61800-3:2004 + A1:2012, which defines categories (C1 to C4) for device application areas.

Depending on the motor cable length, a classification of HYDROVAR by category (based on EN61800-3) is reported in the following tables:

HVL	HYDROVAR classification by categories based on EN61800-3
2.015 ÷ 2.040	C1 (*)
3.015 ÷ 3.110	C2 (*)
4.015 ÷ 4.220	C2 (*)

(\*) 0,75 motor cable length; contact Xylem for further information

En-Rev\_A

## CARD

### Premium Card HYDROVAR (optional)

For the e-SVH series, the Premium Card comes fitted as option on the standalone HYDROVAR.

This allows to control up to five fix speed pumps via an external panel.

The Premium Card will allow additional features listed below:

- 2 additional Analog Inputs
- 2 Analog Outputs
- 1 additional digital input
- 5 relays.

Booster set GHV...SV...C

(See identification code pag.20).



### Wi-Fi Card HYDROVAR (optional)

With the WiFi card fitted in the HYDROVAR, the unit can will allow you to be connected to a wireless network.

Booster set GHV...SV...W

(See identification code pag.20)

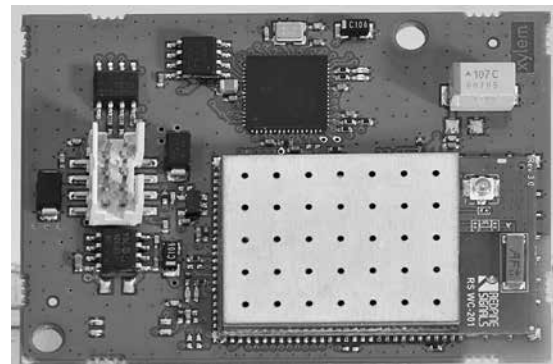

## OPTIONAL COMPONENTS

### Sensors

The following sensors are available for HYDROVAR:

- Pressure-transducer
- Differential pressure-transducer
- Temperature-sensor
- Flow indicator (orifice plate, inductive flow meter)
- Level-sensor.

## HYDROVAR® HVL (WALL MOUNTING KIT) DIMENSIONS AND WEIGHTS

As an option a HYDROVAR® wall mounting kit is also available, this is used where mounting on the pump unit is impossible or where you would like the controls in another location, these are available for the new generation HYDROVAR® HVL 2.015-4.220 (22 kW). The speed of the cooling fan modulates with the HYDROVAR® usage which optimizes energy consumption and also reduces noise.

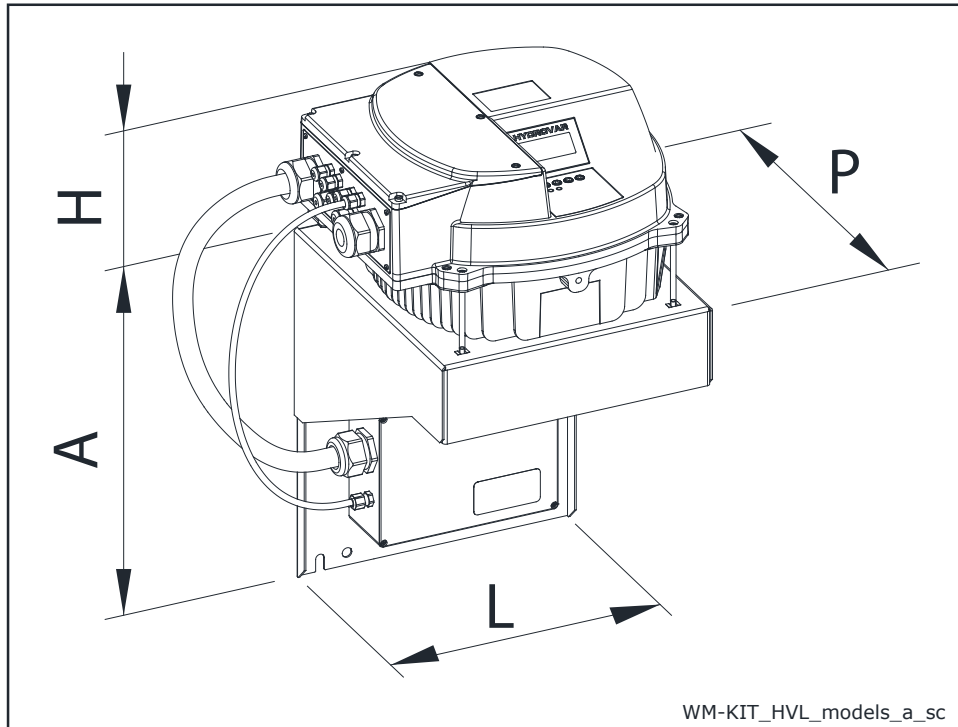

WM KIT TYPE	kW	WM KIT POWER SUPPLY	HVL SIZE	DIMENSIONS (mm)				WEIGHT (kg)	
				A	H	L	P	HVL	WM KIT
WM KIT HVL 2.015	1,5	1~ 230V	A	220	170	202	232	5,6	2,6
WM KIT HVL 2.022	2,2			220	170	202	232	5,6	2,6
WM KIT HVL 2.030	3		B	240	175	258	290	10,5	8,2
WM KIT HVL 2.040	4			320	175	288	305	10,5	5,4
WM KIT HVL 3.015	1,5	3~ 230V	A	220	170	202	232	5,6	2,6
WM KIT HVL 3.022	2,2			220	170	202	232	5,6	2,6
WM KIT HVL 3.030	3		B	240	175	258	290	10,5	8,2
WM KIT HVL 3.040	4			240	175	258	290	10,5	8,2
WM KIT HVL 3.055	5,5		C	240	175	258	290	10,5	8,2
WM KIT HVL 3.075	7,5			400	200	325	365	15,6	11,6
WM KIT HVL 3.110	11		400	200	325	365	15,6	11,6	
WM KIT HVL 4.015	1,5		3~ 400V	A	240	170	258	290	5,6
WM KIT HVL 4.022	2,2	240			170	258	290	5,6	8,2
WM KIT HVL 4.030	3	240			170	258	290	5,6	8,2
WM KIT HVL 4.040	4	240			170	258	290	5,6	8,2
WM KIT HVL 4.055	5,5	B		240	175	258	290	10,5	8,2
WM KIT HVL 4.075	7,5			240	175	258	290	10,5	8,2
WM KIT HVL 4.110	11	C		320	175	288	305	10,5	5,4
WM KIT HVL 4.150	15			400	200	325	365	15,6	11,6
WM KIT HVL 4.185	18,5	C		400	200	325	365	15,6	11,6
WM KIT HVL 4.220	22			400	200	325	365	15,6	11,6

WM-KIT\_HVL\_models-EN\_b\_td

## **GHV.../SV BOOSTER SETS SERIES CONTROL PANEL**

Control and protection panel for electric pumps with HYDROVAR® frequency converters:

- power supply **single-phase 1x230 V** +/-10%, 50/60Hz (GHV.../2)
- power supply **three-phase 3x230 V** +/-10%, 50/60Hz (GHV.../3)
- power supply **three-phase 3x400 V** +/-10%, 50/60Hz (GHV.../4)

### **IP55** protection

Polycarbonate material with clear door, for sets with two pumps and power up to 5.5 kW

Metal for sets with two pumps and powers exceeding 5.5 kW, or for sets with three or four pumps.

The IP65 degree is optional (GHV.../IP65)

Main characteristics:

- Automatic switch with thermal magnetic protection for each HYDROVAR® frequency converter.
- Protection against dry running

Protection against dry running activates when the water reserve falls below the minimum level guaranteed for suction.

The level can be checked using a float switch, a minimum pressure switch, an external contact, or level probes. For the latter, the probes must be connected to the adjustable sensitivity electronic module optional. The control panel is already preset for the installation of this module.

For booster sets requiring a wall mounted control panel (GHV.../WM), the panel is supplied with 5 metre cables.

Other options available:

- GHV.../CP
- GHV.../PA
- GHV.../PE
- GHV.../RE
- GHV.../RV
- GHV.../TE
- GHV.../VA

See the option description on page 20



## GHV.../SV BOOSTER SETS SERIES MAIN COMPONENTS

GHV.../SV

- **Main on-off valves** at the suction and delivery of each pump; ball type up to 2" included. For higher diameters, butterfly valves to be installed between the flanges.
- **Non return valve** on the delivery of each pump; spring type up to 2" included, double head type for larger sizes.
- **Suction manifold** with threaded or flanged ends, depending on set type (see drawings). Threaded fitting for water loading.
- **Delivery manifold** with threaded or flanged ends, depending on set type (see drawings). It has R1" threaded fittings with corresponding caps, for connection with diaphragm expansion vessels (hydro tube).
- **Pressure gauge and transmitters** for control, installed on the delivery manifold of the set.
- **Control** panel.
- **Various fittings** for the connections.
- **Support base** for the pump set and control panel bracket.
- **Anti-vibration feet** sized depending on the set. For some sets, the assembling is the responsibility of the customer.

### Versions available

Manifolds, valves, flanges, base and main components made of AISI 304 or AISI 316 stainless steel; versions:  
GHV.../A304, GHV.../B304, GHV.../C304,  
GHV.../A316, GHV.../B316, GHV.../C316  
Available in the Z version.

### Accessories on request:

- Devices **for protection against dry running** in one of the following versions:
  - float switch
  - pack of electronic module and probe electrodes
  - minimum pressure switch
- **Diaphragm expansion vessel kit**  
Hydrotube with on-off valve, depending on the maximum head of the pump:
  - 24 lt, 8 bar hydro tube kit
  - 24 lt, 10 bar hydro tube kit
  - 24 lt, 16 bar hydro tube kit
  - 20 lt, 25 bar hydro tube kit

### SPECIAL EQUIPMENT ON REQUEST (Contact the Sales and Technical Assistance Service)

- Sets with stainless steel expansion vessels.
- Sets with special valves.
- Sets with 5 to 8 electric pumps.
- Sets with jockey pump.

**GHV series booster sets with e-SV are certified for use with drinking water according to WRAS and ACS standards, and with Italian Ministry Decree no. 174.**



## GHV.../SV BOOSTER SETS SERIES

### MATERIAL TABLE FOR SETS PUMPS, 3-5-10-15-22SV

DENOMINATION	G... (STANDARD)	G.../A304	G.../A316
Manifolds	AISI 304	AISI 304	AISI 316
On-off valves	Nickel-plated brass	AISI 316	AISI 316
Non-return valves	Brass	AISI 304	AISI 316
Pressure switches	Galvanized steel/AISI 301	AISI 301	AISI 301
Pressure transmitters	AISI 304	AISI 304	AISI 304
Caps/plugs/flanges	AISI 304 / 316	AISI 304 / 316	AISI 316
Fittings	AISI 316	AISI 316	AISI 316
Bracket	Galvanized steel/painted steel	Galvanized steel/painted steel	Galvanized steel/painted steel
Base	Painted steel	Painted steel	Painted steel

g\_wad\_3-22sv-en\_a\_tm

GHV.../SV

### MATERIAL TABLE FOR SETS WITH PUMPS, 33-46-66-92-125SV

DENOMINATION	G... (STANDARD)	G.../A304	G.../A316
Manifolds	AISI 304	AISI 304	AISI 316
On-off valves	Epoxy	AISI 316	AISI 316
Non-return valves	Painted cast iron with stainless steel flaps	AISI 304	AISI 316
Pressure switches	Galvanized steel/AISI 301	AISI 301	AISI 301
Pressure transmitters	AISI 316	AISI 316	AISI 316
Caps/plugs/flanges	AISI 304 / 316	AISI 316	AISI 316
Fittings	AISI 316	AISI 316	AISI 316
Bracket	Painted steel	Painted steel	Painted steel
Base	Painted steel	Painted steel	Painted steel

g\_wad\_33-125sv-en\_c\_tm

## GHV.../SV BOOSTER SETS SERIES WORKING LIMITS

The input pressure of the pump, added to the pressure with the port shut off, must not exceed the maximum permitted operating pressure (PN) of the set.

Permitted liquids	Water without gases and corrosive and/or aggressive substances.
Fluid temperature	-10°C to + 80 °C
Ambient temperature	0°C to + 40 °C
Maximum operating pressure*	Max 16 bar
Minimum input pressure	In line with the NPSH curve and the losses, with a margin of at least 0,5 m
Maximum input pressure	The input pressure added to the pump pressure without flow must be lower than the maximum operating pressure of the set.
Installation	Internal environment protected from atmospheric agents. Away from heat sources. Max altitude 1000 a.s.l. Max humidity 50%, without condensation.
Sound emission	See table

\* Higher PN available on request depending on pump type

ghvl\_2p-en\_a\_ti

**SPECIAL SETS**

**HYDROVAR® AND CONTROL PANEL INSTALLED ON DELIVERY SIDE BRACKET**

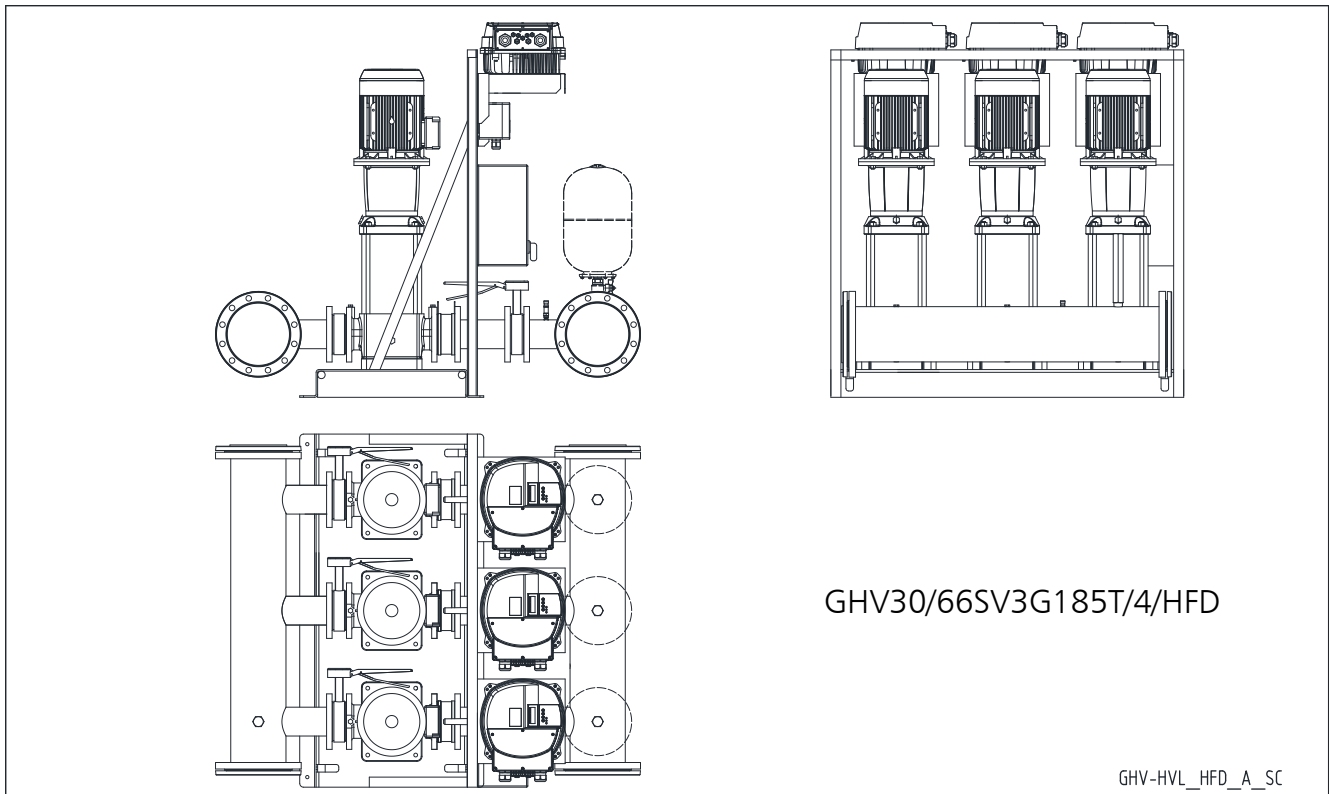

**GHV.../SV**

**HYDROVAR® AND CONTROL PANEL INSTALLED ON SUCTION SIDE BRACKET**

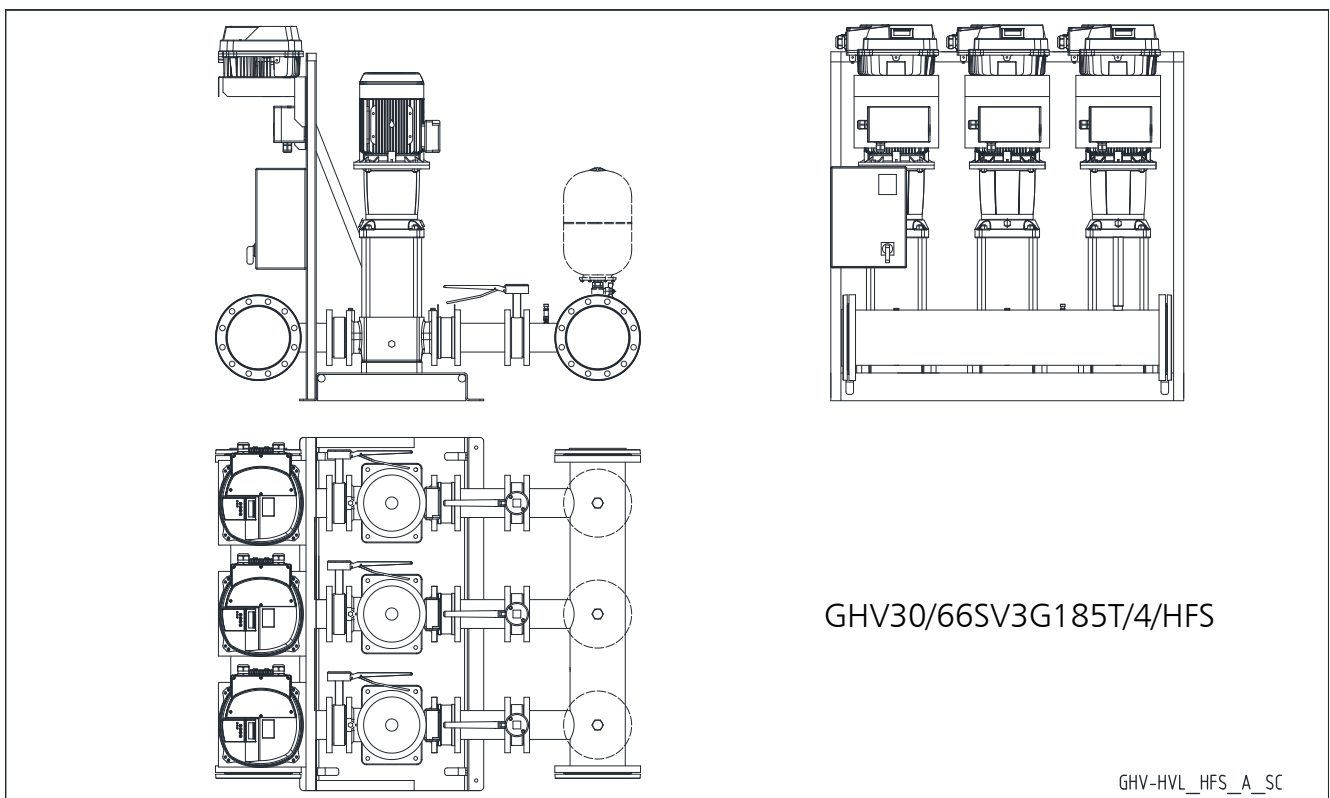

**SPECIAL SETS  
VERSION WITH 5/6 PUMPS**

GHV.../SV

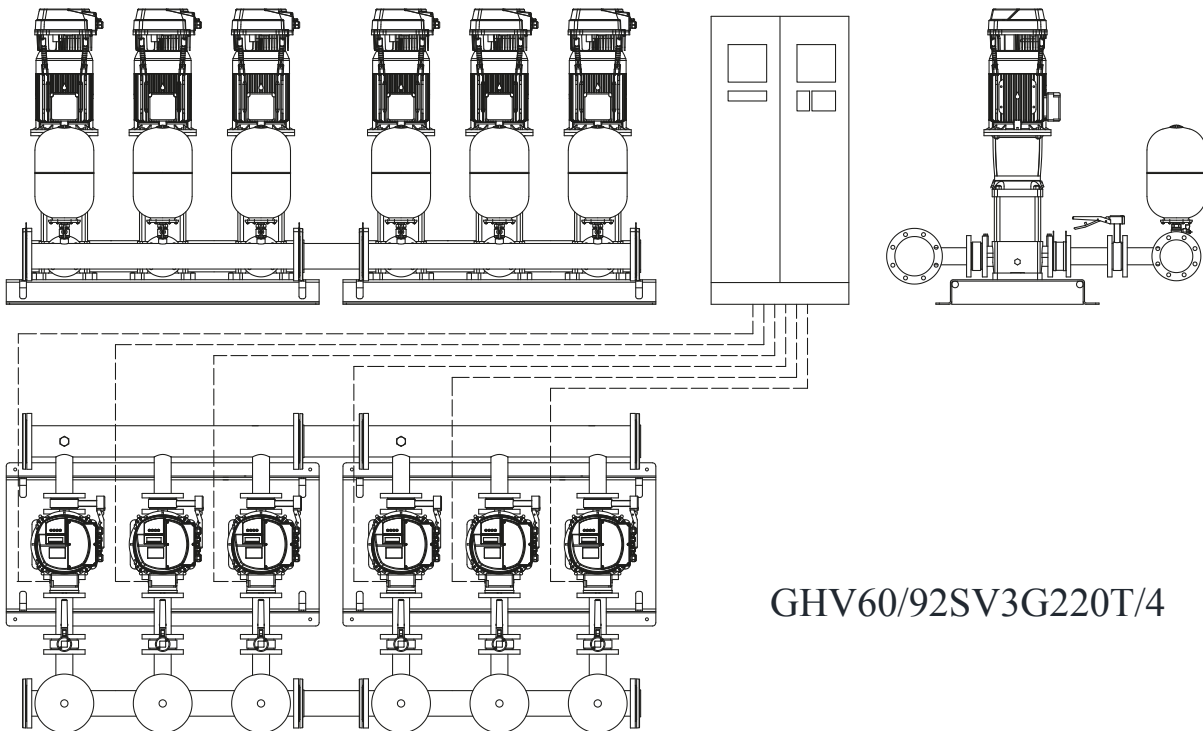
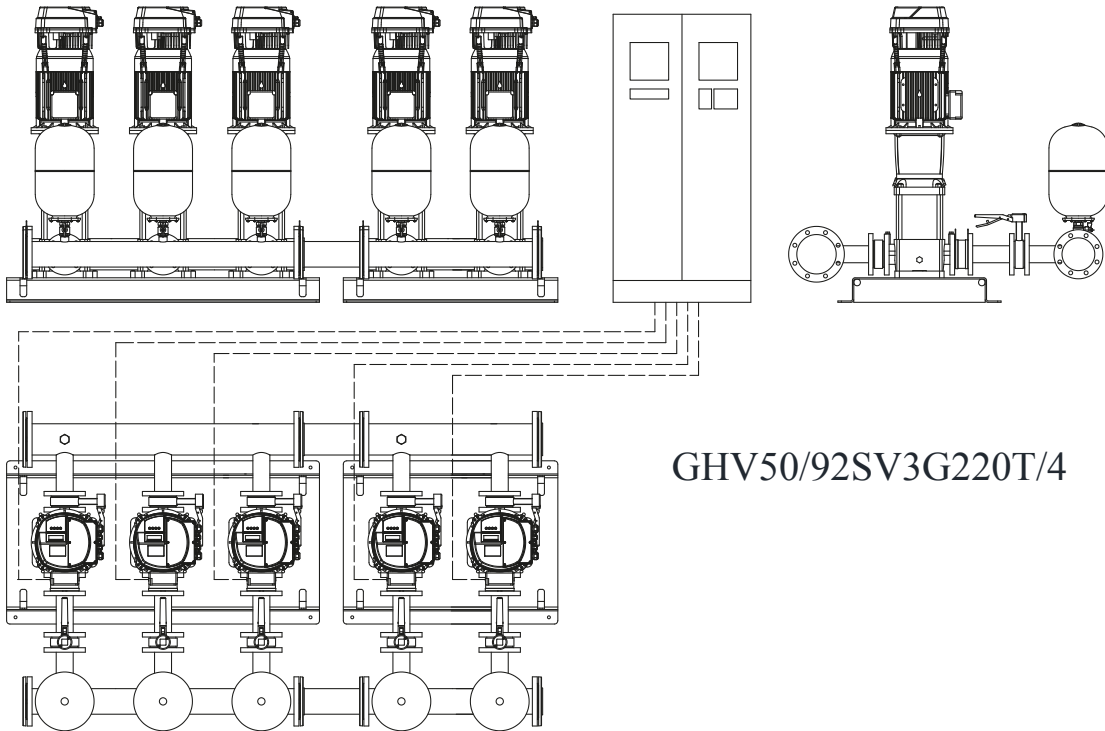

GHV\_SPEC-SV\_B\_DD

Note: please request other special versions with regard to materials used, working temperatures, electric panels with additional functions.

## TABLE OF HYDRAULIC PERFORMANCE AT 50 Hz (SERVICE PUMP) GHV20/3SV BOOSTER SETS SERIES

PUMP TYPE	RATED POWER kW	MEI ≥ (1)	Q = DELIVERY													
			l/min 0	24	40	50	60	70	80	90	100	120	146	200	240	282
			m <sup>3</sup> /h 0	1,4	2,4	3,0	3,6	4,2	4,8	5,4	6,0	7,2	8,8	12,0	14,4	16,9
H = TOTAL HEAD IN METRES OF COLUMN OF WATER																
3SV05	2 x 0,55	0,70	37,2		36,4	35,8	35,0	33,9	32,6	31,1	29,2	24,5	16,2			
3SV06	2 x 0,55	0,70	44,4		43,4	42,6	41,6	40,2	38,6	36,6	34,3	28,5	18,5			
3SV07	2 x 0,75	0,70	52,5		51,8	51,0	50,0	48,7	47,0	45,0	42,5	36,1	24,6			
3SV08	2 x 0,75	0,70	60,0		59,1	58,2	57,0	55,4	53,4	51,0	48,1	40,7	27,5			
3SV09	2 x 1,1	0,70	67,7		66,8	65,8	64,5	62,8	60,6	57,9	54,6	46,4	31,6			
3SV10	2 x 1,1	0,70	75,0		73,8	72,7	71,3	69,3	66,9	63,8	60,2	51,0	34,5			
3SV11	2 x 1,1	0,70	82,3		81,0	79,7	78,0	75,8	73,1	69,7	65,7	55,5	37,4			
3SV12	2 x 1,1	0,70	89,6		87,8	86,4	84,5	82,1	79,1	75,5	71,1	59,9	40,1			
3SV13	2 x 1,5	0,70	98,1		96,7	95,4	93,5	91,0	87,8	83,9	79,2	67,2	45,6			
3SV14	2 x 1,5	0,70	105,6		104,1	102,5	100,4	97,7	94,2	89,9	84,8	71,8	48,5			
3SV16	2 x 1,5	0,70	119,9		117,8	116,1	113,6	110,5	106,5	101,6	95,8	80,9	54,2			
3SV19	2 x 2,2	0,70	144,3		142,3	140,3	137,5	133,9	129,2	123,5	116,7	99,1	67,6			
3SV21	2 x 2,2	0,70	159,3		156,9	154,6	151,4	147,3	142,1	135,7	128,0	108,5	73,6			

Hydraulic performances in compliance with ISO 9906:2012 - Grade 3B (ex ISO 9906:1999 - Annex A)

2p\_3sv-055-2p50-en\_a\_th

(1) Value referred to the F, T, R, N, V, C, K versions. P version excluded.

The table refers to performance with 2 pumps running.

GHV.../SV

## GHV20/5SV BOOSTER SETS SERIES

PUMP TYPE	RATED POWER kW	MEI ≥ (1)	Q = DELIVERY													
			l/min 0	24	40	50	60	70	80	90	100	120	146	200	240	282
			m <sup>3</sup> /h 0	1,4	2,4	3,0	3,6	4,2	4,8	5,4	6,0	7,2	8,8	12,0	14,4	16,9
H = TOTAL HEAD IN METRES OF COLUMN OF WATER																
5SV03	2 x 0,55	0,70	22,8						21,8	21,6	21,3	20,7	19,7	16,9	14,1	10,3
5SV04	2 x 0,55	0,70	30,0						28,2	27,9	27,5	26,6	25,2	21,2	17,3	12,2
5SV05	2 x 0,75	0,70	38,0						36,4	36,0	35,5	34,5	32,9	28,2	23,5	17,1
5SV06	2 x 1,1	0,70	45,3						43,7	43,3	42,8	41,6	39,6	33,9	28,1	20,3
5SV07	2 x 1,1	0,70	52,7						50,7	50,1	49,5	48,1	45,8	39,1	32,2	23,1
5SV08	2 x 1,1	0,70	60,1						57,6	57,0	56,2	54,6	51,8	44,1	36,2	25,8
5SV09	2 x 1,5	0,70	68,0						65,5	64,8	64,0	62,2	59,3	50,6	41,9	30,2
5SV10	2 x 1,5	0,70	75,5						72,4	71,7	70,8	68,7	65,4	55,7	46,0	33,0
5SV11	2 x 1,5	0,70	82,8						79,3	78,4	77,5	75,2	71,4	60,7	49,9	35,6
5SV12	2 x 2,2	0,70	90,8						88,0	87,0	86,0	83,4	79,3	67,4	55,7	40,5
5SV13	2 x 2,2	0,70	98,3						95,0	94,0	92,8	90,0	85,5	72,6	59,9	43,5
5SV14	2 x 2,2	0,70	105,7						102,0	100,9	99,6	96,6	91,7	77,8	64,0	46,3
5SV15	2 x 2,2	0,70	113,1						109,0	107,8	106,4	103,1	97,8	82,8	68,1	49,1
5SV16	2 x 2,2	0,70	120,5						115,9	114,6	113,1	109,6	103,9	87,8	72,1	51,8
5SV18	2 x 3	0,70	135,8						131,1	129,7	128,0	124,1	117,8	99,9	82,3	59,5
5SV21	2 x 3	0,70	157,9						152,0	150,3	148,3	143,6	136,1	114,9	94,2	67,6

Hydraulic performances in compliance with ISO 9906:2012 - Grade 3B (ex ISO 9906:1999 - Annex A)

2p\_5sv-055-2p50-en\_a\_th

(1) Value referred to the F, T, R, N, V, C, K versions. P version excluded.

The table refers to performance with 2 pumps running.

## GHV20/10SV BOOSTER SETS SERIES

PUMP TYPE	RATED POWER kW	MEI ≥ (1)	Q = DELIVERY													
			l/min 0	166,7	200	266	340	366,7	466	540	660	700	800	860	920	966,7
			m <sup>3</sup> /h 0	10,0	12,0	16,0	20,4	22,0	28,0	32,4	39,6	42,0	48,0	51,6	55,2	58,0
H = TOTAL HEAD IN METRES OF COLUMN OF WATER																
10SV01	2 x 0,75	0,70	11,8	11,2	10,9	9,9	8,3	7,6	4,3							
10SV02	2 x 0,75	0,70	23,6	21,9	21,3	19,6	17,0	15,8	10,0							
10SV03	2 x 1,1	0,70	35,7	33,0	32,1	29,6	25,8	24,1	16,0							
10SV04	2 x 1,5	0,70	47,7	44,2	43,0	39,9	34,8	32,6	21,7							
10SV05	2 x 2,2	0,70	60,0	56,1	54,7	50,9	44,9	42,2	29,0							
10SV06	2 x 2,2	0,70	71,8	66,8	65,0	60,4	53,1	49,8	33,9							
10SV07	2 x 3	0,70	83,6	78,3	76,2	70,8	62,1	58,3	39,8							
10SV08	2 x 3	0,70	95,3	88,9	86,5	80,1	70,2	65,7	44,5							
10SV09	2 x 4	0,70	106,3	100,1	97,5	90,8	80,0	75,1	52,1							
10SV10	2 x 4	0,70	118,0	110,8	107,9	100,3	88,2	82,8	57,2							
10SV11	2 x 4	0,70	129,6	121,3	118,1	109,6	96,3	90,3	62,1							

Hydraulic performances in compliance with ISO 9906:2012 - Grade 3B (ex ISO 9906:1999 - Annex A)

2p\_10sv-040-2p50-en\_a\_th

(1) Value referred to the F, T, R, N, V, C, K versions. P version excluded.

The table refers to performance with 2 pumps running.

## GHV20/15SV BOOSTER SETS SERIES

PUMP TYPE	RATED POWER kW	MEI ≥ (1)	Q = DELIVERY													
			l/min 0	166,7	200	266	340	366,7	466	540	660	700	800	860	920	966,7
			m <sup>3</sup> /h 0	10,0	12,0	16,0	20,4	22,0	28,0	32,4	39,6	42,0	48,0	51,6	55,2	58,0
H = TOTAL HEAD IN METRES OF COLUMN OF WATER																
15SV01	2 x 1,1	0,70	14,0			12,9	12,4	12,2	11,3	10,4	8,4	7,6	5,1			
15SV02	2 x 2,2	0,70	28,7			26,7	25,9	25,5	23,9	22,4	18,9	17,4	13,1			
15SV03	2 x 3	0,70	43,3			40,4	39,1	38,6	36,2	33,8	28,7	26,5	20,1			
15SV04	2 x 4	0,70	58,4			54,7	53,1	52,5	49,4	46,3	39,7	36,9	28,7			
15SV05	2 x 4	0,70	72,7			67,8	65,8	65,0	61,0	57,1	48,7	45,2	34,9			
15SV06	2 x 5,5	0,70	87,6			81,5	79,4	78,4	74,1	69,9	60,3	56,3	44,2			
15SV07	2 x 5,5	0,70	101,9			94,5	91,9	90,8	85,7	80,6	69,4	64,7	50,5			
15SV08	2 x 7,5	0,70	117,4			110,9	108,0	106,8	100,8	94,9	82,0	76,7	60,6			
15SV09	2 x 7,5	0,70	131,9			124,4	121,0	119,6	112,8	106,1	91,5	85,5	67,4			
15SV10	2 x 11	0,70	147,7			138,8	135,3	133,8	126,7	119,6	103,9	97,4	77,5			

Hydraulic performances in compliance with ISO 9906:2012 - Grade 3B (ex ISO 9906:1999 - Annex A)

2p\_15sv-2p50-en\_a\_th

(1) Value referred to the F, T, R, N, V, C, K versions. P version excluded.

The table refers to performance with 2 pumps running.

## GHV20/22SV BOOSTER SETS SERIES

PUMP TYPE	RATED POWER kW	MEI ≥ (1)	Q = DELIVERY														
			l/min 0	166,7	200	266	340	366,7	466	540	660	700	800	860	920	966,7	
			m <sup>3</sup> /h 0	10,0	12,0	16,0	20,4	22,0	28,0	32,4	39,6	42,0	48,0	51,6	55,2	58,0	
H = TOTAL HEAD IN METRES OF COLUMN OF WATER																	
22SV01	2 x 1,1	0,70	14,7						13,5	12,7	12,0	10,4	9,7	7,7	6,3	4,7	3,4
22SV02	2 x 2,2	0,70	30,4						28,4	27,2	26,0	23,3	22,2	18,9	16,6	13,8	11,5
22SV03	2 x 3	0,70	45,4						42,2	40,4	38,5	34,5	32,8	27,8	24,2	20,2	16,6
22SV04	2 x 4	0,70	60,9						56,8	54,4	51,9	46,6	44,4	37,9	33,1	27,7	23,0
22SV05	2 x 5,5	0,70	76,0						70,9	67,9	64,9	58,3	55,6	47,4	41,4	34,7	28,8
22SV06	2 x 7,5	0,70	93,2						88,8	85,7	82,5	75,4	72,4	63,3	56,7	49,1	42,6
22SV07	2 x 7,5	0,70	108,5						103,1	99,4	95,7	87,2	83,7	73,1	65,3	56,5	48,8
22SV08	2 x 11	0,70	124,6						119,2	115,2	111,0	101,6	97,7	85,7	77,0	66,9	58,2
22SV09	2 x 11	0,70	140,1						133,7	129,2	124,4	113,8	109,3	95,8	86,0	74,6	64,8
22SV10	2 x 11	0,70	155,4						148,2	143,1	137,8	125,9	120,9	105,8	94,8	82,3	71,3

Hydraulic performances in compliance with ISO 9906:2012 - Grade 3B (ex ISO 9906:1999 - Annex A)

2p\_22sv-2p50-en\_a\_th

(1) Value referred to the F, T, R, N, V, C, K versions. P version excluded.

The table refers to performance with 2 pumps running.

## GHV20/33SV BOOSTER SETS SERIES

PUMP TYPE	RATED POWER kW	MEI ≥ (1)	Q = DELIVERY										
			l/min 0	500	600	733	833	1000	1167	1333	1500	1800	2000
			m <sup>3</sup> /h 0	30	36	44	50	60	70	80	90	108	120
H = TOTAL HEAD METRES COLUMN OF WATER													
33SV1/1A	2 x 2,2	0,70	17,4	16,2	15,7	15	14	12,2	9,8	6,7			
33SV1	2 x 3	0,70	23,8	21,7	21,2	20	20	17,8	15,5	12,7			
33SV2/2A	2 x 4	0,70	35,1	34,1	33,3	32	30	27	22,4	16,6			
33SV2/1A	2 x 4	0,70	40,8	38,8	37,9	36	35	32	27,5	22,3			
33SV2	2 x 5,5	0,70	47,8	45	44,1	43	41	39	35	29,9			
33SV3/2A	2 x 5,5	0,70	57,7	55,2	53,8	51	49	44	38	29,6			
33SV3/1A	2 x 7,5	0,70	64,5	61,3	60	58	56	51	45	37			
33SV3	2 x 7,5	0,70	71,5	67,4	66,0	64	62	58	52,0	44,6			
33SV4/2A	2 x 7,5	0,70	82	78,8	77	74	72	66	58	47,2			
33SV4/1A	2 x 11	0,70	88,9	85	83	81	78	73	65	55,1			
33SV4	2 x 11	0,70	95,9	91,1	90	87	85	80	73	63,1			
33SV5/2A	2 x 11	0,70	106	101,6	100	96	93	85	76	63			
33SV5/1A	2 x 11	0,70	112,7	107,2	105	102	99	92	82	70			
33SV5	2 x 15	0,70	120,4	114,9	113	110	107	101	92	80,5			
33SV6/2A	2 x 15	0,70	131,2	126,9	125	120	116	108	96	81,2			
33SV6/1A	2 x 15	0,70	139,1	133,5	131	128	124	116	105	90,4			
33SV6	2 x 15	0,70	145,6	139	137	133	129	121	110	96,1			
33SV7/2A	2 x 15	0,70	156	149,9	147	143	138	128	115	98,2			

Hydraulic performances in compliance with ISO 9906:2012 - Grade 3B (ex ISO 9906:1999 - Annex A)

2p\_33sv-2p50-en\_a\_th

The table refers to performance with 2 pumps running.

(1) Value referred to the G and N versions with PN ≤ 16 bar (1600 kPa). P version is excluded.

## GHV20/46SV BOOSTER SETS SERIES

PUMP TYPE	RATED POWER kW	MEI ≥ (1)	Q = DELIVERY										
			l/min 0	500	600	733	833	1000	1167	1333	1500	1800	2000
			m <sup>3</sup> /h 0	30	36	44	50	60	70	80	90	108	120
H = TOTAL HEAD METRES COLUMN OF WATER													
46SV1/1A	2 x 3	0,70	19,5			19	18,8	17,9	16,7	15,1	13,1	8,5	4,6
46SV1	2 x 4	0,70	27,2			24,0	23,5	22,5	21,4	19,9	18,2	14,3	10,8
46SV2/2A	2 x 5,5	0,70	38,8			39,8	39,2	37,8	35,7	32,9	29,4	21,1	13,9
46SV2	2 x 7,5	0,70	52,6			48,5	48	46	44	42	39	31,4	25,1
46SV3/2A	2 x 11	0,70	64,7			65,1	64	62	60	56	52	40	30,8
46SV3	2 x 11	0,70	80,8			74,3	73	71	68	65	60	50	40,7
46SV4/2A	2 x 15	0,70	92,4			90,7	90	87	83	79	73	58	45,6
46SV4	2 x 15	0,70	107,3			99,8	98	96	92	87	82	68	55,9
46SV5/2A	2 x 18,5	0,70	117,2			114,8	113	110	106	100	93	75	60,2
46SV5	2 x 18,5	0,70	134,5			125,1	123	120	116	110	103	86	71,5
46SV6/2A	2 x 22	0,70	144			139,3	138	134	129	122	113	92	73
46SV6	2 x 22	0,70	161			149,9	148	144	139	132	124	104	86

Hydraulic performances in compliance with ISO 9906:2012 - Grade 3B (ex ISO 9906:1999 - Annex A)

2p\_46sv-2p50-en\_a\_th

The table refers to performance with 2 pumps running.

(1) Value referred to the G and N versions with PN ≤ 16 bar (1600 kPa). P version is excluded.

## GHV20/66SV BOOSTER SETS SERIES

PUMP TYPE	RATED POWER kW	MEI ≥ (1)	Q = DELIVERY												
			l/min 0	1000	1200	1400	1500	1800	2000	2400	2600	2833	3200	3600	4000
			m <sup>3</sup> /h 0	60	72	84	90	108	120	144	156	170	192	216	240
H = TOTAL HEAD METRES COLUMN OF WATER															
66SV1/1A	2 x 4	0,70	23,8	21,4	20,7	19,9	19,4	17,8	16,6	13,3	11,2	8,3			
66SV1	2 x 5,5	0,70	29,2	25,8	24,8	23,8	23,3	21,8	20,7	17,9	16,1	13,5			
66SV2/2A	2 x 7,5	0,70	47,5	42,6	41,2	39,5	38,6	36	32,9	26,4	22,2	16,4			
66SV2/1A	2 x 11	0,70	54,2	49,6	48,2	46,7	45,8	42,9	40,6	34,8	31,2	26,2			
66SV2	2 x 11	0,70	60,4	55,7	54,4	52,8	52	49,3	47,1	42	38,9	34,7			
66SV3/2A	2 x 15	0,70	78,4	71,6	70	67	66	62	58	49	43,3	35,3			
66SV3/1A	2 x 15	0,70	84,7	77,8	76	74	72	68	65	56	51	44,0			
66SV3	2 x 18,5	0,70	91,4	84,7	83	81	79	75	72	64	60	53,5			
66SV4/2A	2 x 18,5	0,70	108,9	99,6	97	94	92	86	82	70	63	52,8			
66SV4/1A	2 x 22	0,70	115,2	105,9	103	100	99	93	89	78	71	61,8			
66SV4	2 x 22	0,70	121,6	112,5	110	107	105	100	96	86	79	70,8			

Hydraulic performances in compliance with ISO 9906:2012 - Grade 3B (ex ISO 9906:1999 - Annex A)

2p\_66sv-220-2p50-en\_a\_th

(1) Value referred to the G, N versions. P version excluded.

The table refers to performance with 2 pumps running.

## GHV20/92SV BOOSTER SETS SERIES

PUMP TYPE	RATED POWER kW	MEI ≥ (1)	Q = DELIVERY												
			l/min 0	1000	1200	1400	1500	1800	2000	2400	2600	2833	3200	3600	4000
			m <sup>3</sup> /h 0	60	72	84	90	108	120	144	156	170	192	216	240
H = TOTAL HEAD METRES COLUMN OF WATER															
92SV1/1A	2 x 5,5	0,60	24,5				22,2	21,5	20,9	19,4	18,5	17,3	15,0	11,8	7,9
92SV1	2 x 7,5	0,60	33,5				28,7	27,2	26,2	24,3	23,3	22,2	20,2	17,6	14,3
92SV2/2A	2 x 11	0,60	49,4				45,1	44	42,5	39,6	37,9	35,5	30,9	24,6	16,8
92SV2	2 x 15	0,60	67,8				58,2	55,3	53,4	49,5	47,6	45,2	41,4	36,3	29,6
92SV3/2A	2 x 18,5	0,60	82,4				74	71,6	69,6	65	62,1	58,6	52,2	43,6	32,9
92SV3	2 x 22	0,60	102,2				88	84	81	76	72,6	69,2	63,4	55,9	46,3

Hydraulic performances in compliance with ISO 9906:2012 - Grade 3B (ex ISO 9906:1999 - Annex A)

2p\_92sv-220-2p50-en\_a\_th

(1) Value referred to the G, N versions. P version excluded.

The table refers to performance with 2 pumps running.

## GHV20/125SV BOOSTER SETS SERIES

PUMP TYPE	RATED POWER kW	MEI ≥	Q = DELIVERY											
			l/min 0	1500	1800	2000	2400	2832	3400	3800	4000	4300	4600	2666
			m <sup>3</sup> /h 0	90	108	120	144	170	204	228	240	258	276	320
H = TOTAL HEAD IN METRES OF COLUMN OF WATER														
125SV1	2 x 7,5	-	27,6			20,8	19,8	18,6	16,8	15,3	14,4	12,9	11,3	6,2
125SV2	2 x 15	-	53,8			44,4	42,5	40,4	37,1	34,4	32,9	30,4	27,7	19,6
125SV3	2 x 22	-	80,7			66,5	63,8	60,6	55,7	51,6	49,4	45,7	41,5	29,4

Hydraulic performances in compliance with ISO 9906:2012 - Grade 3B (ex ISO 9906:1999 - Annex A)

2p\_125sv-220-2p50-en\_a\_th

(1) Value referred to the G, N versions. P version excluded.

The table refers to performance with 2 pumps running.



## GHV30/5SV BOOSTER SETS SERIES

PUMP TYPE	RATED POWER kW	MEI ≥ (1)	Q = DELIVERY														
			l/min 0	36	60	75	90	105	120	135	150	180	219	300	360	423	
			m <sup>3</sup> /h 0	2,2	3,6	4,5	5,4	6,3	7,2	8,1	9,0	10,8	13,1	18,0	21,6	25,4	
			H = TOTAL HEAD IN METRES OF COLUMN OF WATER														
5SV03	3 x 0,55	0,70	22,8							21,8	21,6	21,3	20,7	19,7	16,9	14,1	10,3
5SV04	3 x 0,55	0,70	30,0							28,2	27,9	27,5	26,6	25,2	21,2	17,3	12,2
5SV05	3 x 0,75	0,70	38,0							36,4	36,0	35,5	34,5	32,9	28,2	23,5	17,1
5SV06	3 x 1,1	0,70	45,3							43,7	43,3	42,8	41,6	39,6	33,9	28,1	20,3
5SV07	3 x 1,1	0,70	52,7							50,7	50,1	49,5	48,1	45,8	39,1	32,2	23,1
5SV08	3 x 1,1	0,70	60,1							57,6	57,0	56,2	54,6	51,8	44,1	36,2	25,8
5SV09	3 x 1,5	0,70	68,0							65,5	64,8	64,0	62,2	59,3	50,6	41,9	30,2
5SV10	3 x 1,5	0,70	75,5							72,4	71,7	70,8	68,7	65,4	55,7	46,0	33,0
5SV11	3 x 1,5	0,70	82,8							79,3	78,4	77,5	75,2	71,4	60,7	49,9	35,6
5SV12	3 x 2,2	0,70	90,8							88,0	87,0	86,0	83,4	79,3	67,4	55,7	40,5
5SV13	3 x 2,2	0,70	98,3							95,0	94,0	92,8	90,0	85,5	72,6	59,9	43,5
5SV14	3 x 2,2	0,70	105,7							102,0	100,9	99,6	96,6	91,7	77,8	64,0	46,3
5SV15	3 x 2,2	0,70	113,1							109,0	107,8	106,4	103,1	97,8	82,8	68,1	49,1
5SV16	3 x 2,2	0,70	120,5							115,9	114,6	113,1	109,6	103,9	87,8	72,1	51,8
5SV18	3 x 3	0,70	135,8							131,1	129,7	128,0	124,1	117,8	99,9	82,3	59,5
5SV21	3 x 3	0,70	157,9							152,0	150,3	148,3	143,6	136,1	114,9	94,2	67,6

Hydraulic performances in compliance with ISO 9906:2012 - Grade 3B (ex ISO 9906:1999 - Annex A)

3p\_5sv-055-2p50-en\_a\_th

(1) Value referred to the F, T, R, N, V, C, K versions. P version excluded.

The table refers to performance with 3 pumps running.

GHV.../SV

## GHV30/10SV BOOSTER SETS SERIES

PUMP TYPE	RATED POWER kW	MEI ≥ (1)	Q = DELIVERY														
			l/min 0	250	300	399	510	550	699	810	990	1050	1200	1290	1380	1450	
			m <sup>3</sup> /h 0	15	18	23,9	30,6	33	41,9	48,6	59,4	63	72	77,4	82,8	87	
			H = TOTAL HEAD IN METRES OF COLUMN OF WATER														
10SV01	3 x 0,75	0,70	11,8	11,2	10,9	9,9	8,3	7,6	4,3								
10SV02	3 x 0,75	0,70	23,6	21,9	21,3	19,6	17,0	15,8	10,0								
10SV03	3 x 1,1	0,70	35,7	33,0	32,1	29,6	25,8	24,1	16,0								
10SV04	3 x 1,5	0,70	47,7	44,2	43,0	39,9	34,8	32,6	21,7								
10SV05	3 x 2,2	0,70	60,0	56,1	54,7	50,9	44,9	42,2	29,0								
10SV06	3 x 2,2	0,70	71,8	66,8	65,0	60,4	53,1	49,8	33,9								
10SV07	3 x 3	0,70	83,6	78,3	76,2	70,8	62,1	58,3	39,8								
10SV08	3 x 3	0,70	95,3	88,9	86,5	80,1	70,2	65,7	44,5								
10SV09	3 x 4	0,70	106,3	100,1	97,5	90,8	80,0	75,1	52,1								
10SV10	3 x 4	0,70	118,0	110,8	107,9	100,3	88,2	82,8	57,2								
10SV11	3 x 4	0,70	129,6	121,3	118,1	109,6	96,3	90,3	62,1								
10SV13	3 x 5,5	0,70	156,0	146,5	142,7	132,6	116,4	109,2	74,3								

Hydraulic performances in compliance with ISO 9906:2012 - Grade 3B (ex ISO 9906:1999 - Annex A)

3p\_10sv-2p50-en\_a\_th

(1) Value referred to the F, T, R, N, V, C, K versions. P version excluded.

The table refers to performance with 3 pumps running.

## GHV30/15SV BOOSTER SETS SERIES

PUMP TYPE	RATED POWER kW	MEI ≥ (1)	Q = DELIVERY													
			l/min 0	250	300	399	510	550	699	810	990	1050	1200	1290	1380	1450
			m <sup>3</sup> /h 0	15,0	18,0	23,9	30,6	33,0	41,9	48,6	59,4	63,0	72,0	77,4	82,8	87,0
H = TOTAL HEAD IN METRES OF COLUMN OF WATER																
15SV01	3 x 1,1	0,70	14,0				12,9	12,4	12,2	11,3	10,4	8,4	7,6	5,1		
15SV02	3 x 2,2	0,70	28,7				26,7	25,9	25,5	23,9	22,4	18,9	17,4	13,1		
15SV03	3 x 3	0,70	43,3				40,4	39,1	38,6	36,2	33,8	28,7	26,5	20,1		
15SV04	3 x 4	0,70	58,4				54,7	53,1	52,5	49,4	46,3	39,7	36,9	28,7		
15SV05	3 x 4	0,70	72,7				67,8	65,8	65,0	61,0	57,1	48,7	45,2	34,9		
15SV06	3 x 5,5	0,70	87,6				81,5	79,4	78,4	74,1	69,9	60,3	56,3	44,2		
15SV07	3 x 5,5	0,70	101,9				94,5	91,9	90,8	85,7	80,6	69,4	64,7	50,5		
15SV08	3 x 7,5	0,70	117,4				110,9	108,0	106,8	100,8	94,9	82,0	76,7	60,6		
15SV09	3 x 7,5	0,70	131,9				124,4	121,0	119,6	112,8	106,1	91,5	85,5	67,4		
15SV10	3 x 11	0,70	147,7				138,8	135,3	133,8	126,7	119,6	103,9	97,4	77,5		

Hydraulic performances in compliance with ISO 9906:2012 - Grade 3B (ex ISO 9906:1999 - Annex A)

3p\_15sv-2p50-en\_a\_th

(1) Value referred to the F, T, R, N, V, C, K versions. P version excluded.

The table refers to performance with 3 pumps running.

## GHV30/22SV BOOSTER SETS SERIES

PUMP TYPE	RATED POWER kW	MEI ≥ (1)	Q = DELIVERY														
			l/min 0	83,34	100	133	170	183,3	233	270	330	350	400	430	460	483,3	
			m <sup>3</sup> /h 0	5,0	6,0	8,0	10,2	11,0	14,0	16,2	19,8	21,0	24,0	25,8	27,6	29,0	
H = TOTAL HEAD IN METRES OF COLUMN OF WATER																	
22SV01	3 x 1,1	0,70	14,7						13,5	12,7	12,0	10,4	9,7	7,7	6,3	4,7	3,4
22SV02	3 x 2,2	0,70	30,4						28,4	27,2	26,0	23,3	22,2	18,9	16,6	13,8	11,5
22SV03	3 x 3	0,70	45,4						42,2	40,4	38,5	34,5	32,8	27,8	24,2	20,2	16,6
22SV04	3 x 4	0,70	60,9						56,8	54,4	51,9	46,6	44,4	37,9	33,1	27,7	23,0
22SV05	3 x 5,5	0,70	76,0						70,9	67,9	64,9	58,3	55,6	47,4	41,4	34,7	28,8
22SV06	3 x 7,5	0,70	93,2						88,8	85,7	82,5	75,4	72,4	63,3	56,7	49,1	42,6
22SV07	3 x 7,5	0,70	108,5						103,1	99,4	95,7	87,2	83,7	73,1	65,3	56,5	48,8
22SV08	3 x 11	0,70	124,6						119,2	115,2	111,0	101,6	97,7	85,7	77,0	66,9	58,2
22SV09	3 x 11	0,70	140,1						133,7	129,2	124,4	113,8	109,3	95,8	86,0	74,6	64,8
22SV10	3 x 11	0,70	155,4						148,2	143,1	137,8	125,9	120,9	105,8	94,8	82,3	71,3

Hydraulic performances in compliance with ISO 9906:2012 - Grade 3B (ex ISO 9906:1999 - Annex A)

3p\_22sv-2p50-en\_a\_th

(1) Value referred to the F, T, R, N, V, C, K versions. P version excluded.

The table refers to performance with 3 pumps running.

## GHV30/33SV BOOSTER SETS SERIES

PUMP TYPE	RATED POWER kW	MEI ≥ (1)	Q = DELIVERY											
			l/min 0	750	900	1100	1250	1500	1750	2000	2250	2700	3000	
			m <sup>3</sup> /h 0	45	54	66	75	90	105	120	135	162	180	
H = TOTAL HEAD METRES COLUMN OF WATER														
33SV1/1A	3 x 2,2	0,70	17,4	16,2	15,7	15	14	12,2	9,8	6,7				
33SV1	3 x 3	0,70	23,8	21,7	21,2	20	20	17,8	15,5	12,7				
33SV2/2A	3 x 4	0,70	35,1	34,1	33,3	32	30	27	22,4	16,6				
33SV2/1A	3 x 4	0,70	40,8	38,8	37,9	36	35	32	27,5	22,3				
33SV2	3 x 5,5	0,70	47,8	45	44,1	43	41	39	35	29,9				
33SV3/2A	3 x 5,5	0,70	57,7	55,2	53,8	51	49	44	38	29,6				
33SV3/1A	3 x 7,5	0,70	64,5	61,3	60	58	56	51	45	37				
33SV3	3 x 7,5	0,70	71,5	67,4	66,0	64	62	58	52,0	44,6				
33SV4/2A	3 x 7,5	0,70	82	78,8	77	74	72	66	58	47,2				
33SV4/1A	3 x 11	0,70	88,9	85	83	81	78	73	65	55,1				
33SV4	3 x 11	0,70	95,9	91,1	90	87	85	80	73	63,1				
33SV5/2A	3 x 11	0,70	106	101,6	100	96	93	85	76	63				
33SV5/1A	3 x 11	0,70	112,7	107,2	105	102	99	92	82	70				
33SV5	3 x 15	0,70	120,4	114,9	113	110	107	101	92	80,5				
33SV6/2A	3 x 15	0,70	131,2	126,9	125	120	116	108	96	81,2				
33SV6/1A	3 x 15	0,70	139,1	133,5	131	128	124	116	105	90,4				
33SV6	3 x 15	0,70	145,6	139	137	133	129	121	110	96,1				
33SV7/2A	3 x 15	0,70	156	149,9	147	143	138	128	115	98,2				

Hydraulic performances in compliance with ISO 9906:2012 - Grade 3B (ex ISO 9906:1999 - Annex A)

3p\_33sv-2p50-en\_a\_th

(1) Value referred to the G and N versions with PN ≤ 16 bar (1600 kPa). P version is excluded.

The table refers to performance with 3 pumps running.

## GHV30/46SV BOOSTER SETS SERIES

PUMP TYPE	RATED POWER kW	MEI ≥ (1)	Q = DELIVERY										
			l/min 0	750	900	1100	1250	1500	1750	2000	2250	2700	3000
			m <sup>3</sup> /h 0	45	54	66	75	90	105	120	135	162	180
H = TOTAL HEAD METRES COLUMN OF WATER													
46SV1/1A	3 x 3	0,70	19,5			19	18,8	17,9	16,7	15,1	13,1	8,5	4,6
46SV1	3 x 4	0,70	27,2			24,0	23,5	22,5	21,4	19,9	18,2	14,3	10,8
46SV2/2A	3 x 5,5	0,70	38,8			39,8	39,2	37,8	35,7	32,9	29,4	21,1	13,9
46SV2	3 x 7,5	0,70	52,6			48,5	48	46	44	42	39	31,4	25,1
46SV3/2A	3 x 11	0,70	64,7			65,1	64	62	60	56	52	40	30,8
46SV3	3 x 11	0,70	80,8			74,3	73	71	68	65	60	50	40,7
46SV4/2A	3 x 15	0,70	92,4			90,7	90	87	83	79	73	58	45,6
46SV4	3 x 15	0,70	107,3			99,8	98	96	92	87	82	68	55,9
46SV5/2A	3 x 18,5	0,70	117,2			114,8	113	110	106	100	93	75	60,2
46SV5	3 x 18,5	0,70	134,5			125,1	123	120	116	110	103	86	71,5
46SV6/2A	3 x 22	0,70	144			139,3	138	134	129	122	113	92	73
46SV6	3 x 22	0,70	161			149,9	148	144	139	132	124	104	86

Hydraulic performances in compliance with ISO 9906:2012 - Grade 3B (ex ISO 9906:1999 - Annex A)

3p\_46sv-2p50-en\_a\_th

(1) Value referred to the G and N versions with PN ≤ 16 bar (1600 kPa). P version is excluded.

The table refers to performance with 3 pumps running.

GHV.../SV

## GHV30/66SV BOOSTER SETS SERIES

PUMP TYPE	RATED POWER kW	MEI ≥ (1)	Q = DELIVERY												
			l/min 0	1500	1800	2100	2250	2700	3000	3600	3900	4250	4800	5400	6000
			m <sup>3</sup> /h 0	90	108	126	135	162	180	216	234	255	288	324	360
H = TOTAL HEAD METRES COLUMN OF WATER															
66SV1/1A	3 x 4	0,70	23,8	21,4	20,7	19,9	19,4	17,8	16,6	13,3	11,2	8,3			
66SV1	3 x 5,5	0,70	29,2	25,8	24,8	23,8	23,3	21,8	20,7	17,9	16,1	13,5			
66SV2/2A	3 x 7,5	0,70	47,5	42,6	41,2	39,5	38,6	36	32,9	26,4	22,2	16,4			
66SV2/1A	3 x 11	0,70	54,2	49,6	48,2	46,7	45,8	42,9	40,6	34,8	31,2	26,2			
66SV2	3 x 11	0,70	60,4	55,7	54,4	52,8	52	49,3	47,1	42	38,9	34,7			
66SV3/2A	3 x 15	0,70	78,4	71,6	70	67	66	62	58	49	43,3	35,3			
66SV3/1A	3 x 15	0,70	84,7	77,8	76	74	72	68	65	56	51	44,0			
66SV3	3 x 18,5	0,70	91,4	84,7	83	81	79	75	72	64	60	53,5			
66SV4/2A	3 x 18,5	0,70	108,9	99,6	97	94	92	86	82	70	63	52,8			
66SV4/1A	3 x 22	0,70	115,2	105,9	103	100	99	93	89	78	71	61,8			
66SV4	3 x 22	0,70	121,6	112,5	110	107	105	100	96	86	79	70,8			

Hydraulic performances in compliance with ISO 9906:2012 - Grade 3B (ex ISO 9906:1999 - Annex A)

3p\_66sv-220-2p50-en\_a\_th

(1) Value referred to the G, N versions. P version excluded.

The table refers to performance with 3 pumps running.

## GHV30/92SV BOOSTER SETS SERIES

PUMP TYPE	RATED POWER kW	MEI ≥ (1)	Q = DELIVERY												
			l/min 0	1500	1800	2100	2250	2700	3000	3600	3900	4250	4800	5400	6000
			m <sup>3</sup> /h 0	90	108	126	135	162	180	216	234	255	288	324	360
H = TOTAL HEAD METRES COLUMN OF WATER															
92SV1/1A	3 x 5,5	0,60	24,5				22,2	21,5	20,9	19,4	18,5	17,3	15,0	11,8	7,9
92SV1	3 x 7,5	0,60	33,5				28,7	27,2	26,2	24,3	23,3	22,2	20,2	17,6	14,3
92SV2/2A	3 x 11	0,60	49,4				45,1	44	42,5	39,6	37,9	35,5	30,9	24,6	16,8
92SV2	3 x 15	0,60	67,8				58,2	55,3	53,4	49,5	47,6	45,2	41,4	36,3	29,6
92SV3/2A	3 x 18,5	0,60	82,4				74	71,6	69,6	65	62,1	58,6	52,2	43,6	32,9
92SV3	3 x 22	0,60	102,2				88	84	81	76	72,6	69,2	63,4	55,9	46,3

Hydraulic performances in compliance with ISO 9906:2012 - Grade 3B (ex ISO 9906:1999 - Annex A)

3p\_92sv-220-2p50-en\_a\_th

(1) Value referred to the G, N versions. P version excluded.

The table refers to performance with 3 pumps running.

## GHV30/125SV BOOSTER SETS SERIES

PUMP TYPE	RATED POWER kW	MEI ≥	Q = DELIVERY											
			l/min 0	2250	2700	3000	3600	4248	5100	5700	6000	6450	6900	2666
			m <sup>3</sup> /h 0	135	162	180	216	255	306	342	360	387	414	480
H = TOTAL HEAD IN METRES OF COLUMN OF WATER														
125SV1	3 x 7,5	-	27,6			20,8	19,8	18,6	16,8	15,3	14,4	12,9	11,3	6,2
125SV2	3 x 15	-	53,8			44,4	42,5	40,4	37,1	34,4	32,9	30,4	27,7	19,6
125SV3	3 x 22	-	80,7			66,5	63,8	60,6	55,7	51,6	49,4	45,7	41,5	29,4

Hydraulic performances in compliance with ISO 9906:2012 - Grade 3B (ex ISO 9906:1999 - Annex A)

3p\_125sv-220-2p50-en\_a\_th

(1) Value referred to the G, N versions. P version excluded.

The table refers to performance with 3 pumps running.

## GHV40/10SV BOOSTER SETS SERIES

PUMP TYPE	RATED POWER kW	MEI ≥ (1)	Q = DELIVERY													
			l/min 0	333,4	400	532	680	733,4	932	1080	1320	1400	1600	1720	1840	1933
			m <sup>3</sup> /h 0	20,0	24,0	31,9	40,8	44,0	55,9	64,8	79,2	84,0	96,0	103,2	110,4	116,0
H = TOTAL HEAD IN METRES OF COLUMN OF WATER																
10SV01	4 x 0,75	0,70	11,8	11,2	10,9	9,9	8,3	7,6	4,3							
10SV02	4 x 0,75	0,70	23,6	21,9	21,3	19,6	17,0	15,8	10,0							
10SV03	4 x 1,1	0,70	35,7	33,0	32,1	29,6	25,8	24,1	16,0							
10SV04	4 x 1,5	0,70	47,7	44,2	43,0	39,9	34,8	32,6	21,7							
10SV05	4 x 2,2	0,70	60,0	56,1	54,7	50,9	44,9	42,2	29,0							
10SV06	4 x 2,2	0,70	71,8	66,8	65,0	60,4	53,1	49,8	33,9							
10SV07	4 x 3	0,70	83,6	78,3	76,2	70,8	62,1	58,3	39,8							
10SV08	4 x 3	0,70	95,3	88,9	86,5	80,1	70,2	65,7	44,5							
10SV09	4 x 4	0,70	106,3	100,1	97,5	90,8	80,0	75,1	52,1							
10SV10	4 x 4	0,70	118,0	110,8	107,9	100,3	88,2	82,8	57,2							
10SV11	4 x 4	0,70	129,6	121,3	118,1	109,6	96,3	90,3	62,1							
10SV13	4 x 5,5	0,70	156,0	146,5	142,7	132,6	116,4	109,2	74,3							

Hydraulic performances in compliance with ISO 9906:2012 - Grade 3B (ex ISO 9906:1999 - Annex A)

4p\_10sv-2p50-en\_a\_th

(1) Value referred to the F, T, R, N, V, C, K versions. P version excluded.

The table refers to performance with 4 pumps running.

GHV.../SV

## GHV40/15SV BOOSTER SETS SERIES

PUMP TYPE	RATED POWER kW	MEI ≥ (1)	Q = DELIVERY													
			l/min 0	333,4	400	532	680	733,4	932	1080	1320	1400	1600	1720	1840	1933
			m <sup>3</sup> /h 0	20,0	24,0	31,9	40,8	44,0	55,9	64,8	79,2	84,0	96,0	103,2	110,4	116,0
H = TOTAL HEAD IN METRES OF COLUMN OF WATER																
15SV01	4 x 1,1	0,70	14,0			12,9	12,4	12,2	11,3	10,4	8,4	7,6	5,1			
15SV02	4 x 2,2	0,70	28,7			26,7	25,9	25,5	23,9	22,4	18,9	17,4	13,1			
15SV03	4 x 3	0,70	43,3			40,4	39,1	38,6	36,2	33,8	28,7	26,5	20,1			
15SV04	4 x 4	0,70	58,4			54,7	53,1	52,5	49,4	46,3	39,7	36,9	28,7			
15SV05	4 x 4	0,70	72,7			67,8	65,8	65,0	61,0	57,1	48,7	45,2	34,9			
15SV06	4 x 5,5	0,70	87,6			81,5	79,4	78,4	74,1	69,9	60,3	56,3	44,2			
15SV07	4 x 5,5	0,70	101,9			94,5	91,9	90,8	85,7	80,6	69,4	64,7	50,5			
15SV08	4 x 7,5	0,70	117,4			110,9	108,0	106,8	100,8	94,9	82,0	76,7	60,6			
15SV09	4 x 7,5	0,70	131,9			124,4	121,0	119,6	112,8	106,1	91,5	85,5	67,4			
15SV10	4 x 11	0,70	147,7			138,8	135,3	133,8	126,7	119,6	103,9	97,4	77,5			

Hydraulic performances in compliance with ISO 9906:2012 - Grade 3B (ex ISO 9906:1999 - Annex A)

4p\_15sv-2p50-en\_a\_th

(1) Value referred to the F, T, R, N, V, C, K versions. P version excluded.

The table refers to performance with 4 pumps running.

## GHV40/22SV BOOSTER SETS SERIES

PUMP TYPE	RATED POWER kW	MEI ≥ (1)	Q = DELIVERY														
			l/min 0	83,34	100	133	170	183,3	233	270	330	350	400	430	460	483,3	
			m <sup>3</sup> /h 0	5,0	6,0	8,0	10,2	11,0	14,0	16,2	19,8	21,0	24,0	25,8	27,6	29,0	
H = TOTAL HEAD IN METRES OF COLUMN OF WATER																	
22SV01	4 x 1,1	0,70	14,7						13,5	12,7	12,0	10,4	9,7	7,7	6,3	4,7	3,4
22SV02	4 x 2,2	0,70	30,4						28,4	27,2	26,0	23,3	22,2	18,9	16,6	13,8	11,5
22SV03	4 x 3	0,70	45,4						42,2	40,4	38,5	34,5	32,8	27,8	24,2	20,2	16,6
22SV04	4 x 4	0,70	60,9						56,8	54,4	51,9	46,6	44,4	37,9	33,1	27,7	23,0
22SV05	4 x 5,5	0,70	76,0						70,9	67,9	64,9	58,3	55,6	47,4	41,4	34,7	28,8
22SV06	4 x 7,5	0,70	93,2						88,8	85,7	82,5	75,4	72,4	63,3	56,7	49,1	42,6
22SV07	4 x 7,5	0,70	108,5						103,1	99,4	95,7	87,2	83,7	73,1	65,3	56,5	48,8
22SV08	4 x 11	0,70	124,6						119,2	115,2	111,0	101,6	97,7	85,7	77,0	66,9	58,2
22SV09	4 x 11	0,70	140,1						133,7	129,2	124,4	113,8	109,3	95,8	86,0	74,6	64,8
22SV10	4 x 11	0,70	155,4						148,2	143,1	137,8	125,9	120,9	105,8	94,8	82,3	71,3

Hydraulic performances in compliance with ISO 9906:2012 - Grade 3B (ex ISO 9906:1999 - Annex A)

4p\_22sv-2p50-en\_a\_th

(1) Value referred to the F, T, R, N, V, C, K versions. P version excluded.

The table refers to performance with 4 pumps running.

## GHV40/33SV BOOSTER SETS SERIES

PUMP TYPE	RATED POWER kW	MEI ≥ (1)	Q = DELIVERY										
			l/min 0	1000	1200	1467	1667	2000	2333	2667	3000	3600	4000
			m <sup>3</sup> /h 0	60	72	88	100	120	140	160	180	216	240
H = TOTAL HEAD METRES COLUMN OF WATER													
33SV1/1A	4 x 2,2	0,70	17,4	16,2	15,7	15	14	12,2	9,8	6,7			
33SV1	4 x 3	0,70	23,8	21,7	21,2	20	20	17,8	15,5	12,7			
33SV2/2A	4 x 4	0,70	35,1	34,1	33,3	32	30	27	22,4	16,6			
33SV2/1A	4 x 4	0,70	40,8	38,8	37,9	36	35	32	27,5	22,3			
33SV2	4 x 5,5	0,70	47,8	45	44,1	43	41	39	35	29,9			
33SV3/2A	4 x 5,5	0,70	57,7	55,2	53,8	51	49	44	38	29,6			
33SV3/1A	4 x 7,5	0,70	64,5	61,3	60	58	56	51	45	37			
33SV3	4 x 7,5	0,70	71,5	67,4	66,0	64	62	58	52,0	44,6			
33SV4/2A	4 x 7,5	0,70	82	78,8	77	74	72	66	58	47,2			
33SV4/1A	4 x 11	0,70	88,9	85	83	81	78	73	65	55,1			
33SV4	4 x 11	0,70	95,9	91,1	90	87	85	80	73	63,1			
33SV5/2A	4 x 11	0,70	106	101,6	100	96	93	85	76	63			
33SV5/1A	4 x 11	0,70	112,7	107,2	105	102	99	92	82	70			
33SV5	4 x 15	0,70	120,4	114,9	113	110	107	101	92	80,5			
33SV6/2A	4 x 15	0,70	131,2	126,9	125	120	116	108	96	81,2			
33SV6/1A	4 x 15	0,70	139,1	133,5	131	128	124	116	105	90,4			
33SV6	4 x 15	0,70	145,6	139	137	133	129	121	110	96,1			
33SV7/2A	4 x 15	0,70	156	149,9	147	143	138	128	115	98,2			

Hydraulic performances in compliance with ISO 9906:2012 - Grade 3B (ex ISO 9906:1999 - Annex A)

4p\_33sv-2p50-en\_a\_th

(1) Value referred to the G and N versions with PN ≤ 16 bar (1600 kPa). P version is excluded.

The table refers to performance with 4 pumps running.

## GHV40/46SV BOOSTER SETS SERIES

PUMP TYPE	RATED POWER kW	MEI ≥ (1)	Q = DELIVERY										
			l/min 0	1000	1200	1467	1667	2000	2333	2667	3000	3600	4000
			m <sup>3</sup> /h 0	60	72	88	100	120	140	160	180	216	240
H = TOTAL HEAD METRES COLUMN OF WATER													
46SV1/1A	4 x 3	0,70	19,5			19	18,8	17,9	16,7	15,1	13,1	8,5	4,6
46SV1	4 x 4	0,70	27,2			24,0	23,5	22,5	21,4	19,9	18,2	14,3	10,8
46SV2/2A	4 x 5,5	0,70	38,8			39,8	39,2	37,8	35,7	32,9	29,4	21,1	13,9
46SV2	4 x 7,5	0,70	52,6			48,5	48	46	44	42	39	31,4	25,1
46SV3/2A	4 x 11	0,70	64,7			65,1	64	62	60	56	52	40	30,8
46SV3	4 x 11	0,70	80,8			74,3	73	71	68	65	60	50	40,7
46SV4/2A	4 x 15	0,70	92,4			90,7	90	87	83	79	73	58	45,6
46SV4	4 x 15	0,70	107,3			99,8	98	96	92	87	82	68	55,9
46SV5/2A	4 x 18,5	0,70	117,2			114,8	113	110	106	100	93	75	60,2
46SV5	4 x 18,5	0,70	134,5			125,1	123	120	116	110	103	86	71,5
46SV6/2A	4 x 22	0,70	144			139,3	138	134	129	122	113	92	73
46SV6	4 x 22	0,70	161			149,9	148	144	139	132	124	104	86

Hydraulic performances in compliance with ISO 9906:2012 - Grade 3B (ex ISO 9906:1999 - Annex A)

4p\_46sv-2p50-en\_a\_th

(1) Value referred to the G and N versions with PN ≤ 16 bar (1600 kPa). P version is excluded.

The table refers to performance with 4 pumps running.

## GHV40/66SV BOOSTER SETS SERIES

PUMP TYPE	RATED POWER kW	MEI ≥ (1)	Q = DELIVERY												
			l/min 0	2000	2400	2800	3000	3600	4000	4800	5200	5667	6400	7200	8000
			m <sup>3</sup> /h 0	120	144	168	180	216	240	288	312	340	384	432	480
H = TOTAL HEAD METRES COLUMN OF WATER															
66SV1/1A	4 x 4	0,70	23,8	21,4	20,7	19,9	19,4	17,8	16,6	13,3	11,2	8,3			
66SV1	4 x 5,5	0,70	29,2	25,8	24,8	23,8	23,3	21,8	20,7	17,9	16,1	13,5			
66SV2/2A	4 x 7,5	0,70	47,5	42,6	41,2	39,5	38,6	36	32,9	26,4	22,2	16,4			
66SV2/1A	4 x 11	0,70	54,2	49,6	48,2	46,7	45,8	42,9	40,6	34,8	31,2	26,2			
66SV2	4 x 11	0,70	60,4	55,7	54,4	52,8	52	49,3	47,1	42	38,9	34,7			
66SV3/2A	4 x 15	0,70	78,4	71,6	70	67	66	62	58	49	43,3	35,3			
66SV3/1A	4 x 15	0,70	84,7	77,8	76	74	72	68	65	56	51	44,0			
66SV3	4 x 18,5	0,70	91,4	84,7	83	81	79	75	72	64	60	53,5			
66SV4/2A	4 x 18,5	0,70	108,9	99,6	97	94	92	86	82	70	63	52,8			
66SV4/1A	4 x 22	0,70	115,2	105,9	103	100	99	93	89	78	71	61,8			
66SV4	4 x 22	0,70	121,6	112,5	110	107	105	100	96	86	79	70,8			

Hydraulic performances in compliance with ISO 9906:2012 - Grade 3B (ex ISO 9906:1999 - Annex A)

4p\_66sv-220-2p50-en\_a\_th

(1) Value referred to the G, N versions. P version excluded.

The table refers to performance with 4 pumps running.

## GHV40/92SV BOOSTER SETS SERIES

PUMP TYPE	RATED POWER kW	MEI ≥ (1)	Q = DELIVERY												
			l/min 0	2000	2400	2800	3000	3600	4000	4800	5200	5667	6400	7200	8000
			m <sup>3</sup> /h 0	120	144	168	180	216	240	288	312	340	384	432	480
H = TOTAL HEAD METRES COLUMN OF WATER															
92SV1/1A	4 x 5,5	0,60	24,5				22,2	21,5	20,9	19,4	18,5	17,3	15,0	11,8	7,9
92SV1	4 x 7,5	0,60	33,5				28,7	27,2	26,2	24,3	23,3	22,2	20,2	17,6	14,3
92SV2/2A	4 x 11	0,60	49,4				45,1	44	42,5	39,6	37,9	35,5	30,9	24,6	16,8
92SV2	4 x 15	0,60	67,8				58,2	55,3	53,4	49,5	47,6	45,2	41,4	36,3	29,6
92SV3/2A	4 x 18,5	0,60	82,4				74	71,6	69,6	65	62,1	58,6	52,2	43,6	32,9
92SV3	4 x 22	0,60	102,2				88	84	81	76	72,6	69,2	63,4	55,9	46,3

Hydraulic performances in compliance with ISO 9906:2012 - Grade 3B (ex ISO 9906:1999 - Annex A)

4p\_92sv-220-2p50-en\_a\_th

(1) Value referred to the G, N versions. P version excluded.

The table refers to performance with 4 pumps running.

## GHV40/125SV BOOSTER SETS SERIES

PUMP TYPE	RATED POWER kW	MEI ≥	Q = DELIVERY												
			l/min 0	3000	3600	4000	4800	5664	6800	7600	8000	8600	9200	2666	
			m <sup>3</sup> /h 0	180	216	240	288	340	408	456	480	516	552	640	
H = TOTAL HEAD IN METRES OF COLUMN OF WATER															
125SV1	4 x 7,5	-	27,6			20,8	19,8	18,6	16,8	15,3	14,4	12,9	11,3	6,2	
125SV2	4 x 15	-	53,8			44,4	42,5	40,4	37,1	34,4	32,9	30,4	27,7	19,6	
125SV3	4 x 22	-	80,7			66,5	63,8	60,6	55,7	51,6	49,4	45,7	41,5	29,4	

Hydraulic performances in compliance with ISO 9906:2012 - Grade 3B (ex ISO 9906:1999 - Annex A)

4p\_125sv-220-2p50-en\_a\_th

(1) Value referred to the G, N versions. P version excluded.

The table refers to performance with 4 pumps running.

## GHV.../SV BOOSTER SETS SERIES ELECTRICAL DATA TABLE AT 50 Hz

GHV.../SV

ELECTRIC PUMP  TYPE	kW	CURRENT ABSORBED (A)					
		GHV20		GHV30		GHV40	
		/2	/4	/2	/4	/2	/4
		1 ~ 230V	3 ~ 400V	1 ~ 230V	3 ~ 400V	1 ~ 230V	3 ~ 400V
3SV05	0,55	5,8	2,1	-	-	-	-
3SV06	0,55	5,8	2,1	-	-	-	-
3SV07	0,75	8,0	2,8	-	-	-	-
3SV08	0,75	8,0	2,8	-	-	-	-
3SV09	1,1	11,7	4,1	-	-	-	-
3SV10	1,1	11,7	4,1	-	-	-	-
3SV11	1,1	11,7	4,1	-	-	-	-
3SV12	1,1	11,7	4,1	-	-	-	-
3SV13	1,5	15,9	5,7	-	-	-	-
3SV14	1,5	15,9	5,7	-	-	-	-
3SV16	1,5	15,9	5,7	-	-	-	-
3SV19	2,2	23,4	8,3	-	-	-	-
3SV21	2,2	23,4	8,3	-	-	-	-
5SV03	0,55	5,8	2,1	-	3,1	-	-
5SV04	0,55	5,8	2,1	-	3,1	-	-
5SV05	0,75	8,0	2,8	-	4,2	-	-
5SV06	1,1	11,7	4,1	-	6,2	-	-
5SV07	1,1	11,7	4,1	-	6,2	-	-
5SV08	1,1	11,7	4,1	-	6,2	-	-
5SV09	1,5	15,9	5,7	-	8,5	-	-
5SV10	1,5	15,9	5,7	-	8,5	-	-
5SV11	1,5	15,9	5,7	-	8,5	-	-
5SV12	2,2	23,4	8,3	-	12,4	-	-
5SV13	2,2	23,4	8,3	-	12,4	-	-
5SV14	2,2	23,4	8,3	-	12,4	-	-
5SV15	2,2	23,4	8,3	-	12,4	-	-
5SV16	2,2	23,4	8,3	-	12,4	-	-
5SV18	3	-	11,2	-	16,9	-	-
5SV21	3	-	11,2	-	16,9	-	-
10SV01	0,75	8,0	2,8	-	4,2	-	21,3
10SV02	0,75	8,0	2,8	-	4,2	-	21,3
10SV03	1,1	11,7	4,1	-	6,2	-	8,3
10SV04	1,5	15,9	4,1	-	8,5	-	11,3
10SV05	2,2	23,4	8,3	-	12,4	-	16,6
10SV06	2,2	23,4	8,3	-	12,4	-	16,6
10SV07	3	-	11,2	-	16,9	-	22,5
10SV08	3	-	11,2	-	16,9	-	22,5
10SV09	4	-	14,6	-	21,9	-	29,2
10SV10	4	-	14,6	-	21,9	-	29,2
10SV11	4	-	14,6	-	21,9	-	29,2
10SV13	5,5	-	-	-	30,2	-	40,3

ELECTRIC PUMP  TYPE	kW	CURRENT ABSORBED (A)					
		GHV20		GHV30		GHV40	
		/2	/4	/2	/4	/2	/4
		1 ~ 230V	3 ~ 400V	1 ~ 230V	3 ~ 400V	1 ~ 230V	3 ~ 400V
15SV01	1,1	-	4,1	-	6,2	-	8,3
15SV02	2,2	-	8,3	-	12,4	-	16,6
15SV03	3	-	11,2	-	16,9	-	22,5
15SV04	4	-	14,6	-	21,9	-	29,2
15SV05	4	-	14,6	-	21,9	-	29,2
15SV06	5,5	-	20,1	-	30,2	-	40,3
15SV07	5,5	-	20,1	-	30,2	-	40,3
15SV08	7,5	-	27,3	-	41,0	-	54,7
15SV09	7,5	-	27,3	-	41,0	-	54,7
15SV10	11	-	38,7	-	58,1	-	77,5
22SV01	1,1	-	4,1	-	6,2	-	8,3
22SV02	2,2	-	8,3	-	12,4	-	16,6
22SV03	3	-	11,2	-	16,9	-	22,5
22SV04	4	-	14,6	-	21,9	-	29,2
22SV05	5,5	-	20,1	-	30,2	-	40,3
22SV06	7,5	-	27,3	-	41,0	-	54,7
22SV07	7,5	-	27,3	-	41,0	-	54,7
22SV08	11	-	38,7	-	58,1	-	77,5
22SV09	11	-	38,7	-	58,1	-	77,5
22SV10	11	-	38,7	-	58,1	-	77,5

GHV-3\_15SV-HVL-2p50-en\_a\_te



## GHV.../SV BOOSTER SETS SERIES ELECTRICAL DATA TABLE AT 50 Hz

ELECTRIC PUMP  TYPE	kW	CURRENT ABSORBED (A)					
		GHV20		GHV30		GHV40	
		/2	/4	/2	/4	/2	/4
		1 ~ 230V	3 ~ 400V	1 ~ 230V	3 ~ 400V	1 ~ 230V	3 ~ 400V
33SV1/1A	2,2	-	8,3	-	12,4	-	16,6
33SV1	3	-	11,2	-	16,9	-	22,5
33SV2/2A	4	-	14,6	-	21,9	-	29,2
33SV2/1A	4	-	14,6	-	21,9	-	29,2
33SV2	5,5	-	20,1	-	30,2	-	41,4
33SV3/2A	5,5	-	20,1	-	30,2	-	41,4
33SV3/1A	7,5	-	27,3	-	41,0	-	54,7
33SV3	7,5	-	27,3	-	41,0	-	54,7
33SV4/2A	7,5	-	27,3	-	41,0	-	54,7
33SV4/1A	11	-	38,7	-	58,1	-	77,5
33SV4	11	-	38,7	-	58,1	-	77,5
33SV5/2A	11	-	38,7	-	58,1	-	77,5
33SV5/1A	11	-	38,7	-	58,1	-	77,5
33SV5	15	-	52,2	-	78,3	-	104,4
33SV6/2A	15	-	52,2	-	78,3	-	104,4
33SV6/1A	15	-	52,2	-	78,3	-	104,4
33SV6	15	-	52,2	-	78,3	-	104,4
33SV7/2A	15	-	52,2	-	78,3	-	104,4
46SV1/1A	3	-	11,2	-	16,9	-	22,5
46SV1	4	-	14,6	-	21,9	-	29,2
46SV2/2A	5,5	-	20,1	-	30,2	-	41,4
46SV2	7,5	-	27,3	-	41,0	-	54,7
46SV3/2A	11	-	38,7	-	58,1	-	77,5
46SV3	11	-	38,7	-	58,1	-	77,5
46SV4/2A	15	-	52,2	-	78,3	-	104,4
46SV4	15	-	52,2	-	78,3	-	104,4
46SV5/2A	18,5	-	64,3	-	96,4	-	128,6
46SV5	18,5	-	64,3	-	96,4	-	128,6
46SV6/2A	22	-	76,1	-	114,2	-	152,2
46SV6	22	-	76,1	-	114,2	-	152,2

ELECTRIC PUMP  TYPE	kW	CURRENT ABSORBED (A)					
		GHV20		GHV30		GHV40	
		/2	/4	/2	/4	/2	/4
		1 ~ 230V	3 ~ 400V	1 ~ 230V	3 ~ 400V	1 ~ 230V	3 ~ 400V
66SV1/1A	4	-	14,6	-	21,9	-	29,2
66SV1	5,5	-	20,1	-	30,2	-	41,4
66SV2/2A	7,5	-	27,3	-	41,0	-	54,7
66SV2/1A	11	-	38,7	-	58,1	-	77,5
66SV2	11	-	38,7	-	58,1	-	77,5
66SV3/2A	15	-	52,2	-	78,3	-	104,4
66SV3/1A	15	-	52,2	-	78,3	-	104,4
66SV3	18,5	-	64,3	-	96,4	-	128,6
66SV4/2A	18,5	-	64,3	-	96,4	-	128,6
66SV4/1A	22	-	76,1	-	114,2	-	152,2
66SV4	22	-	76,1	-	114,2	-	152,2
92SV1/1A	5,5	-	20,1	-	30,2	-	41,4
92SV1	7,5	-	27,3	-	41,0	-	54,7
92SV2/2A	11	-	38,7	-	58,1	-	77,5
92SV2	15	-	52,2	-	78,3	-	104,4
92SV3/2A	18,5	-	64,3	-	96,4	-	128,6
92SV3	22	-	76,1	-	114,2	-	152,2
125SV1	7,5	-	27,3	-	41,0	-	54,7
125SV2	15	-	52,2	-	78,3	-	104,4
125SV3	22	-	76,1	-	114,2	-	152,2

GHV-33\_125SV-HVL-2p50-en\_a\_te

## Booster sets

**MARKET SECTORS**  
RESIDENTIAL-CIVIL, INDUSTRIAL

### APPLICATIONS

- Water network supply in housing complexes, offices, hotels, shopping centres, industrial plants.
- Supply of water networks for agricultural applications (e.g. irrigation).

## GHV20 Series

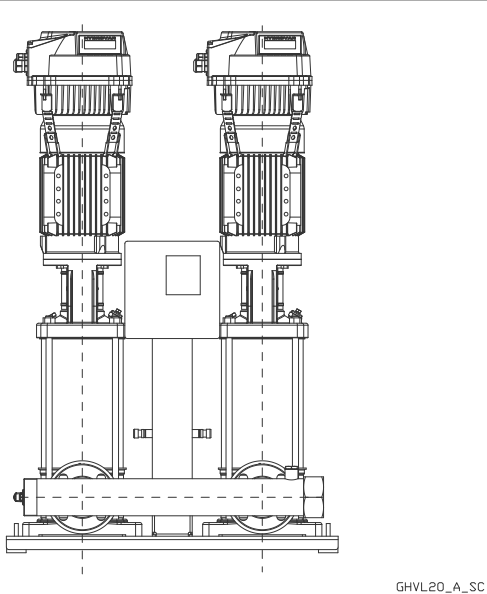

GHV20

## SPECIFICATIONS

- **Flow rate**  
up to 320 m<sup>3</sup>/h.
- **Head**  
up to 160 m.
- Electrical panel **supply voltage**:  
- single-phase 1 x 230V ± 10% 50/60Hz (GHV.../2)  
- three-phase 3 x 400V ± 10% 50/60Hz (GHV.../4)
- **Frequency** 50Hz
- **e-SV™** vertical axis electric pump
- **HVL** series HYDROVAR®
- **Protection class IP55** for:  
- electrical control panel  
- electrical pump motor  
- HVL converter
- Maximum operating **pressure**:  
16 bar.
- Maximum liquid **temperature**:  
max +80°C.
- Maximum electric pump **power**:  
2 x 22 kW.
- **Progressive** motor start.

**GHV series booster sets with e-SV are certified for use with drinking water according to WRAS and ACS standards, and with Italian Ministry Decree no. 174.**

**SET OF 2 PUMPS  
SINGLE-PHASE POWER SUPPLY (GHV20.../2)**

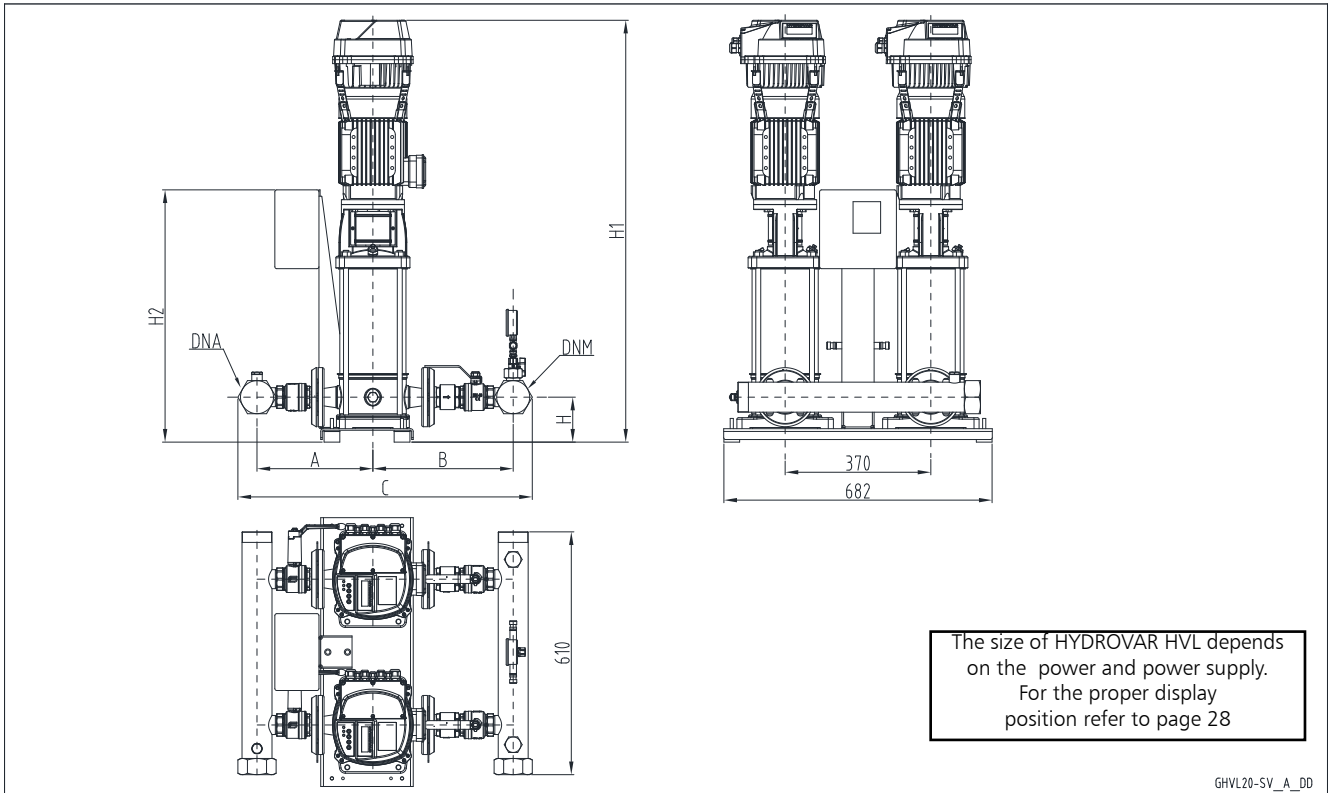

**GHV20**

GHV 20	DNA	DNM	A		B		C		H	H1	H2
			STD	AISI	STD	AISI	STD	AISI			
3SV05F005T	R 2"	R 2"	256	257	311	363	627	680	109	753	640
3SV06F005T	R 2"	R 2"	256	257	311	363	627	680	109	773	640
3SV07F007T	R 2"	R 2"	256	257	311	363	627	680	109	835	640
3SV08F007T	R 2"	R 2"	256	257	311	363	627	680	109	855	640
3SV09F011T	R 2"	R 2"	256	257	311	363	627	680	109	875	640
3SV10F011T	R 2"	R 2"	256	257	311	363	627	680	109	895	640
3SV11F011T	R 2"	R 2"	256	257	311	363	627	680	109	915	640
3SV12F011T	R 2"	R 2"	256	257	311	363	627	680	109	935	640
3SV13F015T	R 2"	R 2"	256	257	311	363	627	680	109	965	640
3SV14F015T	R 2"	R 2"	256	257	311	363	627	680	109	985	640
3SV16F015T	R 2"	R 2"	256	257	311	363	627	680	109	1025	640
3SV19F022T	R 2"	R 2"	256	257	311	363	627	680	109	1120	640
3SV21F022T	R 2"	R 2"	256	257	311	363	627	680	109	1160	640
5SV03F005T	R 2"	R 2"	260	267	329	387	649	714	109	728	640
5SV04F005T	R 2"	R 2"	260	267	329	387	649	714	109	753	640
5SV05F007T	R 2"	R 2"	260	267	329	387	649	714	109	820	640
5SV06F011T	R 2"	R 2"	260	267	329	387	649	714	109	845	640
5SV07F011T	R 2"	R 2"	260	267	329	387	649	714	109	870	640
5SV08F011T	R 2"	R 2"	260	267	329	387	649	714	109	895	640
5SV09F015T	R 2"	R 2"	260	267	329	387	649	714	109	930	640
5SV10F015T	R 2"	R 2"	260	267	329	387	649	714	109	955	640
5SV11F015T	R 2"	R 2"	260	267	329	387	649	714	109	980	640
5SV12F022T	R 2"	R 2"	260	267	329	387	649	714	109	1040	640
5SV13F022T	R 2"	R 2"	260	267	329	387	649	714	109	1065	640
5SV14F022T	R 2"	R 2"	260	267	329	387	649	714	109	1090	640
5SV15F022T	R 2"	R 2"	260	267	329	387	649	714	109	1115	640
5SV16F022T	R 2"	R 2"	260	267	329	387	649	714	109	1140	640
10SV01F007T	R 2 1/2	R 2 1/2	294	301	356	453	726	830	114	824	640
10SV02F007T	R 2 1/2	R 2 1/2	294	301	356	453	726	830	114	824	640
10SV03F011T	R 2 1/2	R 2 1/2	294	301	356	453	726	830	114	856	640
10SV04F015T	R 2 1/2	R 2 1/2	294	301	356	453	726	830	114	898	640
10SV05F022T	R 2 1/2	R 2 1/2	294	301	356	453	726	830	114	965	640
10SV06F022T	R 2 1/2	R 2 1/2	294	301	356	453	726	830	114	997	640

Dimensions in mm. Tolerance  $\pm 10$  mm.  
AISI: same dimensions /A304, /A316

ghvm20\_esp-f\_d\_tit

### SET OF 2 PUMPS THREE-PHASE POWER SUPPLY (GHV20.../4)

GHV20

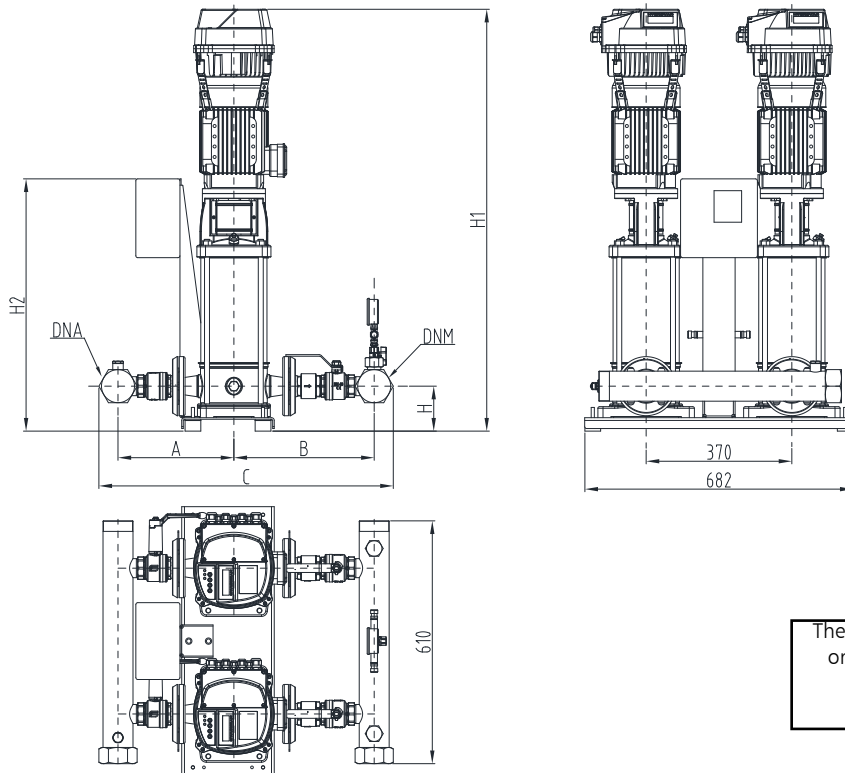

The size of HYDROVAR HVL depends on the power and power supply. For the proper display position refer to page 28

GHVL20-SV\_A\_DD

GHV 20	DNA	DNM	A		B		C		H	H1	H2
			STD	AISI	STD	AISI	STD	AISI			
3SV05F005T	R 2"	R 2"	256	257	311	301	627	680	109	753	640
3SV06F005T	R 2"	R 2"	256	257	311	301	627	680	109	773	640
3SV07F007T	R 2"	R 2"	256	257	311	301	627	680	109	835	640
3SV08F007T	R 2"	R 2"	256	257	311	301	627	680	109	855	640
3SV09F011T	R 2"	R 2"	256	257	311	301	627	680	109	875	640
3SV10F011T	R 2"	R 2"	256	257	311	301	627	680	109	895	640
3SV11F011T	R 2"	R 2"	256	257	311	301	627	680	109	915	640
3SV12F011T	R 2"	R 2"	256	257	311	301	627	680	109	935	640
3SV13F015T	R 2"	R 2"	256	257	311	301	627	680	109	965	640
3SV14F015T	R 2"	R 2"	256	257	311	301	627	680	109	985	640
3SV16F015T	R 2"	R 2"	256	257	311	301	627	680	109	1025	640
3SV19F022T	R 2"	R 2"	256	257	311	301	627	680	109	1120	640
3SV21F022T	R 2"	R 2"	256	257	311	301	627	680	109	1160	640
5SV03F005T	R 2"	R 2"	260	267	329	311	649	714	109	728	640
5SV04F005T	R 2"	R 2"	260	267	329	311	649	714	109	753	640
5SV05F007T	R 2"	R 2"	260	267	329	311	649	714	109	820	640
5SV06F011T	R 2"	R 2"	260	267	329	311	649	714	109	845	640
5SV07F011T	R 2"	R 2"	260	267	329	311	649	714	109	870	640
5SV08F011T	R 2"	R 2"	260	267	329	311	649	714	109	895	640
5SV09F015T	R 2"	R 2"	260	267	329	311	649	714	109	930	640
5SV10F015T	R 2"	R 2"	260	267	329	311	649	714	109	955	640
5SV11F015T	R 2"	R 2"	260	267	329	311	649	714	109	980	640
5SV12F022T	R 2"	R 2"	260	267	329	311	649	714	109	1040	640
5SV13F022T	R 2"	R 2"	260	267	329	311	649	714	109	1065	640
5SV14F022T	R 2"	R 2"	260	267	329	311	649	714	109	1090	640
5SV15F022T	R 2"	R 2"	260	267	329	311	649	714	109	1115	640
5SV16F022T	R 2"	R 2"	260	267	329	311	649	714	109	1140	640
5SV18F030T	R 2"	R 2"	260	267	329	311	649	714	109	1200	640
5SV21F030T	R 2"	R 2"	260	267	329	311	649	714	109	1275	640
10SV01F007T	R 2"1/2	R 2"1/2	294	301	356	356	726	830	114	824	640
10SV02F007T	R 2"1/2	R 2"1/2	294	301	356	356	726	830	114	824	640
10SV03F011T	R 2"1/2	R 2"1/2	294	301	356	356	726	830	114	856	640
10SV04F015T	R 2"1/2	R 2"1/2	294	301	356	356	726	830	114	898	640
10SV05F022T	R 2"1/2	R 2"1/2	294	301	356	356	726	830	114	965	640
10SV06F022T	R 2"1/2	R 2"1/2	294	301	356	356	726	830	114	997	640
10SV07F030T	R 2"1/2	R 2"1/2	294	301	356	356	726	830	114	1039	640
10SV08F030T	R 2"1/2	R 2"1/2	294	301	356	356	726	830	114	1071	640
10SV09F040T	R 2"1/2	R 2"1/2	294	301	356	356	726	830	114	1124	640
10SV10F040T	R 2"1/2	R 2"1/2	294	301	356	356	726	830	114	1156	640
10SV11F040T	R 2"1/2	R 2"1/2	294	301	356	356	726	830	114	1188	640

ghvt20\_esh-f\_c\_ttd

Dimensions in mm. Tolerance ± 10 mm.  
AISI: same dimensions /A304, /A316

## SET OF 2 PUMPS THREE-PHASE POWER SUPPLY (GHV20.../4)

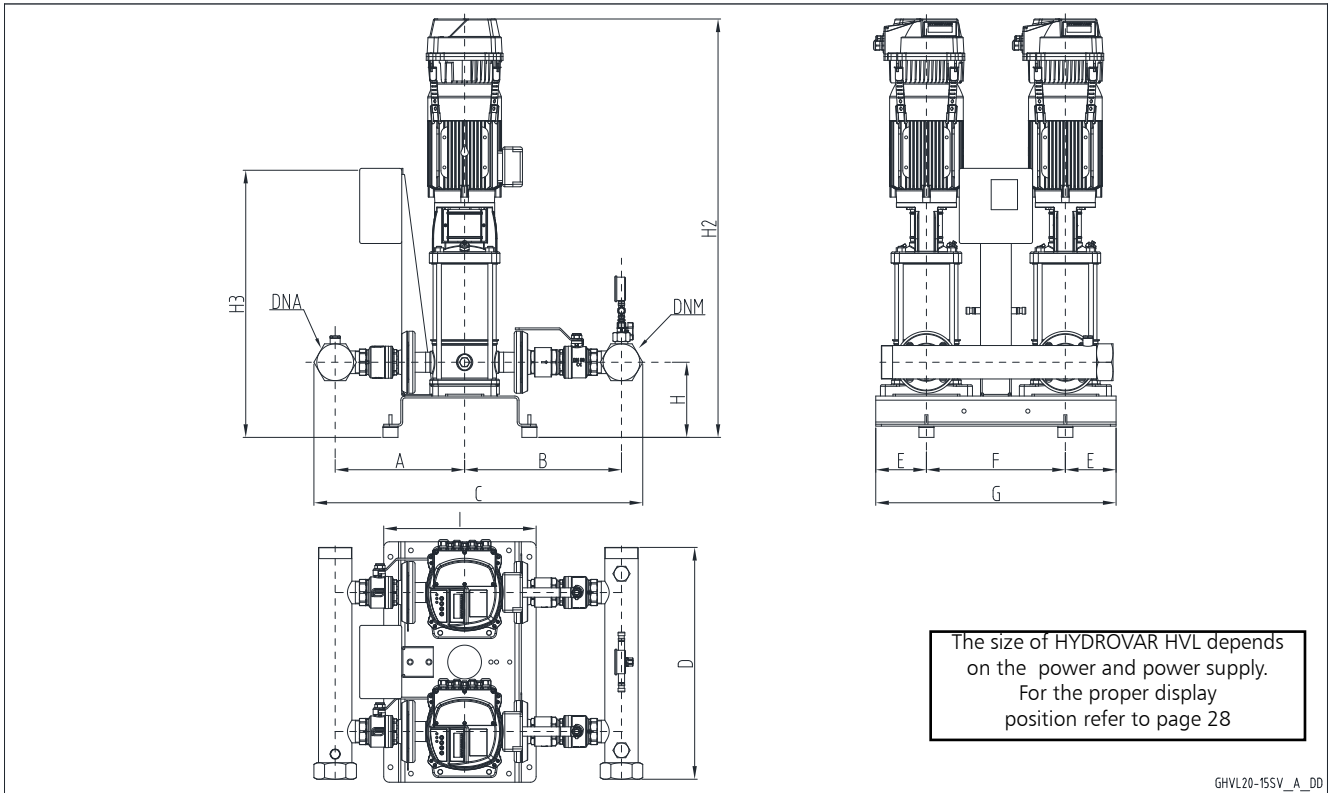

**GHV20**

GHVL20-15SV\_A\_DD

GHV 20	DNA	DNM	A		B		C		D	E	F	G	H	H2	H3	I
			STD	AISI	STD	AISI	STD	AISI								
15SV01F011T	R 3"	R 3"	345	351	418	409	851	848	610	135	370	640	200	942	748	406
15SV02F022T	R 3"	R 3"	345	351	418	409	851	848	610	135	370	640	200	987	748	406
15SV03F030T	R 3"	R 3"	345	351	418	409	851	848	610	135	370	640	200	1045	748	406
15SV04F040T	R 3"	R 3"	345	351	418	409	851	848	610	135	370	640	200	1114	748	406
15SV05F040T	R 3"	R 3"	345	351	418	409	851	848	610	135	370	640	200	1162	748	406
15SV06F055T	R 3"	R 3"	345	351	418	409	851	848	610	135	370	640	200	1348	748	406
15SV07F055T	R 3"	R 3"	345	351	418	409	851	848	610	135	370	640	200	1396	748	406
15SV08F075T	R 3"	R 3"	345	351	418	409	851	848	610	135	370	640	200	1436	748	406
15SV09F075T	R 3"	R 3"	345	351	418	409	851	848	610	135	370	640	200	1484	748	406
15SV10F110T	R 3"	R 3"	345	351	418	409	851	848	680	260	440	960	250	1673	798	730
22SV01F011T	R 3"	R 3"	345	351	418	409	851	848	610	135	370	640	200	942	748	406
22SV02F022T	R 3"	R 3"	345	351	418	409	851	848	610	135	370	640	200	987	748	406
22SV03F030T	R 3"	R 3"	345	351	418	409	851	848	610	135	370	640	200	1045	748	406
22SV04F040T	R 3"	R 3"	345	351	418	409	851	848	610	135	370	640	200	1114	748	406
22SV05F055T	R 3"	R 3"	345	351	418	409	851	848	610	135	370	640	200	1300	748	406
22SV06F075T	R 3"	R 3"	345	351	418	409	851	848	610	135	370	640	200	1340	748	406
22SV07F075T	R 3"	R 3"	345	351	418	409	851	848	610	135	370	640	200	1388	748	406
22SV08F110T	R 3"	R 3"	345	351	418	409	851	848	680	260	440	960	250	1577	847	730
22SV09F110T	R 3"	R 3"	345	351	418	409	851	848	680	260	440	960	250	1625	847	730
22SV10F110T	R 3"	R 3"	345	351	418	409	851	848	680	260	440	960	250	1673	847	730

Dimensions in mm. Tolerance ± 10 mm.  
AISI: same dimensions /A304, /A316

ghv20\_15sv\_e\_td

**SET OF 2 PUMPS  
THREE-PHASE POWER SUPPLY (GHV20.../4)**

**GHV20**

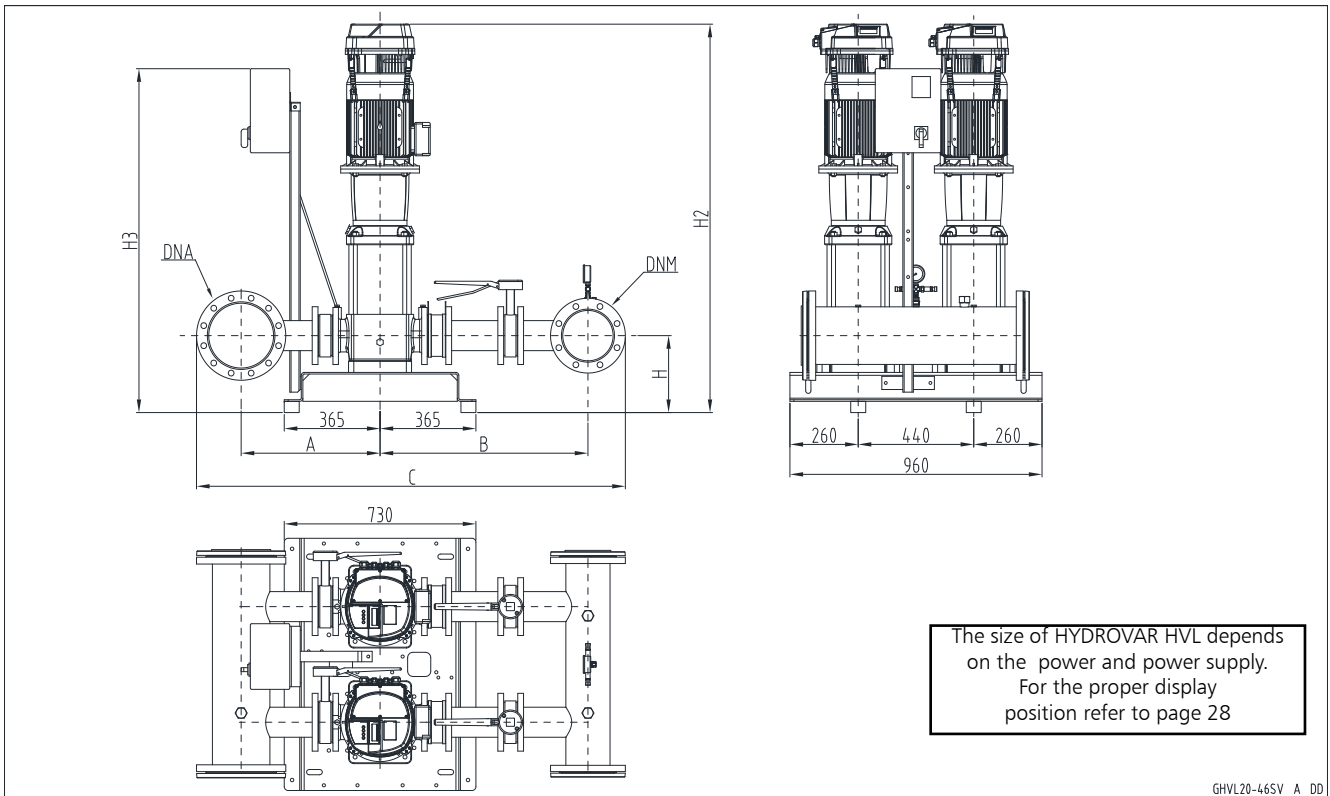

**SET OF 2 PUMPS  
THREE-PHASE POWER SUPPLY (GHV20.../4)**

GHV 20	DNA	DNM	A	B	C	H	H2	H3
33SV1/1AG022T	100	80	448	701	1359	265	1117	1186
33SV1G030T	100	80	448	701	1359	265	1117	1186
33SV2/2AG040T	100	80	448	701	1359	265	1213	1186
33SV2/1AG040T	100	80	448	701	1359	265	1213	1186
33SV2G055T	100	80	448	701	1359	265	1304	1317
33SV3/2AG055T	100	80	448	701	1359	265	1379	1317
33SV3/1AG075T	100	80	448	701	1359	265	1371	1317
33SV3G075T	100	80	448	701	1359	265	1371	1317
33SV4/2AG075T	100	80	448	701	1359	265	1446	1317
33SV4/1AG110T	100	80	448	701	1359	265	1542	1317
33SV4G110T	100	80	448	701	1359	265	1542	1317
33SV5/2AG110T	100	80	448	701	1359	265	1617	1317
33SV5/1AG110T	100	80	448	701	1359	265	1617	1317
33SV5G150T	100	80	448	701	1359	265	1698	1317
33SV6/2AG150T	100	80	448	701	1359	265	1773	1317
33SV6/1AG150T	100	80	448	701	1359	265	1773	1317
33SV6G150T	100	80	448	701	1359	265	1773	1317
33SV7/2AG150T	100	80	448	701	1359	265	1848	1317
46SV1/1AG030T	125	100	484	739	1457	300	1157	1186
46SV1G040T	125	100	484	739	1457	300	1178	1186
46SV2/2AG055T	125	100	484	739	1457	300	1344	1317
46SV2G075T	125	100	484	739	1457	300	1336	1317
46SV3/2AG110T	125	100	484	739	1457	300	1507	1317
46SV3G110T	125	100	484	739	1457	300	1507	1317
46SV4/2AG150T	125	100	484	739	1457	300	1663	1317
46SV4G150T	125	100	484	739	1457	300	1663	1317
46SV5/2AG185T	125	100	484	739	1457	300	1738	1397
46SV5G185T	125	100	484	739	1457	300	1738	1397
46SV6/2AG220T	125	100	484	739	1457	300	1813	1397
46SV6G220T	125	100	484	739	1457	300	1813	1397
66SV1/1AG040T	150	125	504	780	1551	300	1203	1186
66SV1G055T	150	125	504	780	1551	300	1294	1317
66SV2/2AG075T	150	125	504	780	1551	300	1376	1317
66SV2/1AG110T	150	125	504	780	1551	300	1472	1317
66SV2G110T	150	125	504	780	1551	300	1472	1317
66SV3/2AG150T	150	125	504	780	1551	300	1643	1317
66SV3/1AG150T	150	125	504	780	1551	300	1643	1317
66SV3G185T	150	125	504	780	1551	300	1643	1397
66SV4/2AG185T	150	125	504	780	1551	300	1733	1397
66SV4/1AG220T	150	125	504	780	1551	300	1733	1397
66SV4G220T	150	125	504	780	1551	300	1733	1397
92SV1/1AG055T	200	150	529	794	1635	300	1294	1317
92SV1G075T	200	150	529	794	1635	300	1286	1317
92SV2/2AG110T	200	150	529	794	1635	300	1472	1317
92SV2G150T	200	150	529	794	1635	300	1553	1317
92SV3/2AG185T	200	150	529	794	1635	300	1643	1397
92SV3G220T	200	150	529	794	1635	300	1643	1397

Dimensions in mm. Tolerance  $\pm 10$  mm.

ghv20\_sv46-en\_e\_td

AISt: same dimensions /A304, /A316

**GHV20**

**SET OF 2 PUMPS  
THREE-PHASE POWER SUPPLY (GHV20.../4)**

**GHV20**

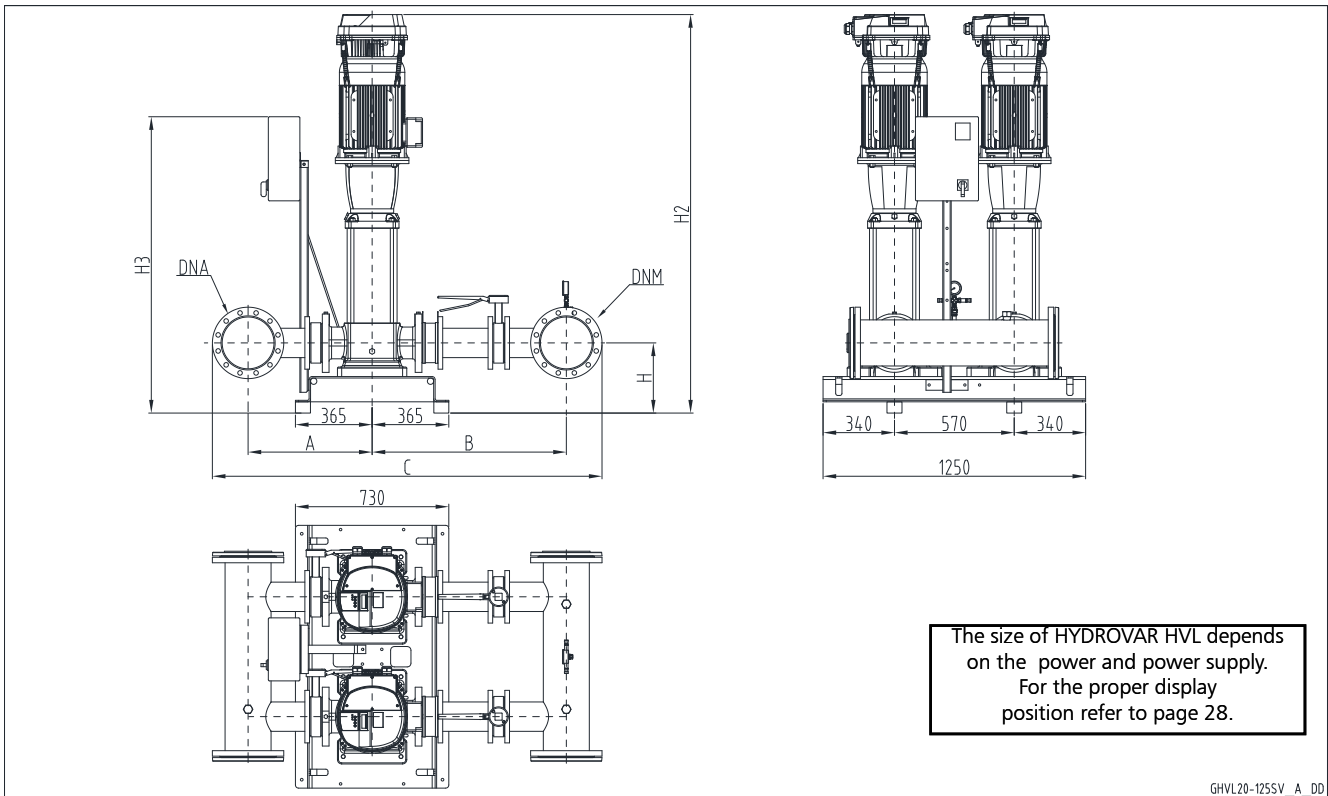

GHV20-125SV\_A\_DD

GHV 20	DNA	DNM	A	B	C	H	H2	H3
125SV1G075T	200	200	591	927	1857	330	1415	1318
125SV2G150T	200	200	591	927	1857	330	1742	1318
125SV3G220T	200	200	591	927	1857	330	1892	1398

Dimensions in mm. Tolerance  $\pm 10$  mm.  
AISI: same dimensions /A304, /A316

ghv20\_125sv-en\_b\_td



## Booster sets

**MARKET SECTORS**  
RESIDENTIAL-CIVIL, INDUSTRIAL

### APPLICATIONS

- Water network supply in housing complexes, offices, hotels, shopping centres, industrial plants.
- Supply of water networks for agricultural applications (e.g. irrigation)

## GHV30 Series

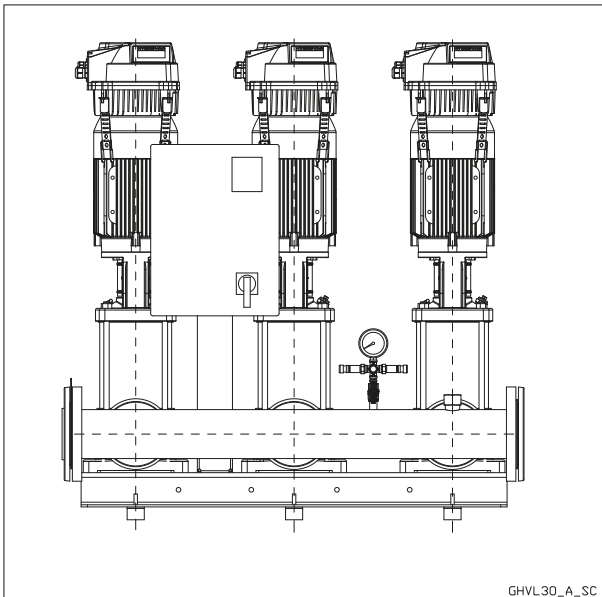

GHV30

## SPECIFICATIONS

- **Flow rate**  
up to 480 m<sup>3</sup>/h.
- **Head**  
up to 160 m.
- Electrical panel **supply voltage**:  
- single-phase 1 x 230V ± 10% 50/60Hz (GHV.../2)  
- three-phase 3 x 400V ± 10% 50/60Hz (GHV.../4)
- **Frequency** 50Hz
- **e-SV™** vertical axis electric pump
- **HVL** series HYDROVAR®
- **Protection class IP55** for:  
- electrical control panel  
- electrical pump motor  
- HVL converter
- Maximum operating **pressure**:  
16 bar.
- Maximum liquid **temperature**:  
max +80°C.
- Maximum electric pump **power**:  
3 x 22 kW.
- **Progressive** motor start.

**GHV series booster sets with e-SV are certified for use with drinking water according to WRAS and ACS standards, and with Italian Ministry Decree no. 174.**

### SET OF 3 PUMPS THREE-PHASE POWER SUPPLY (GHV30.../4)

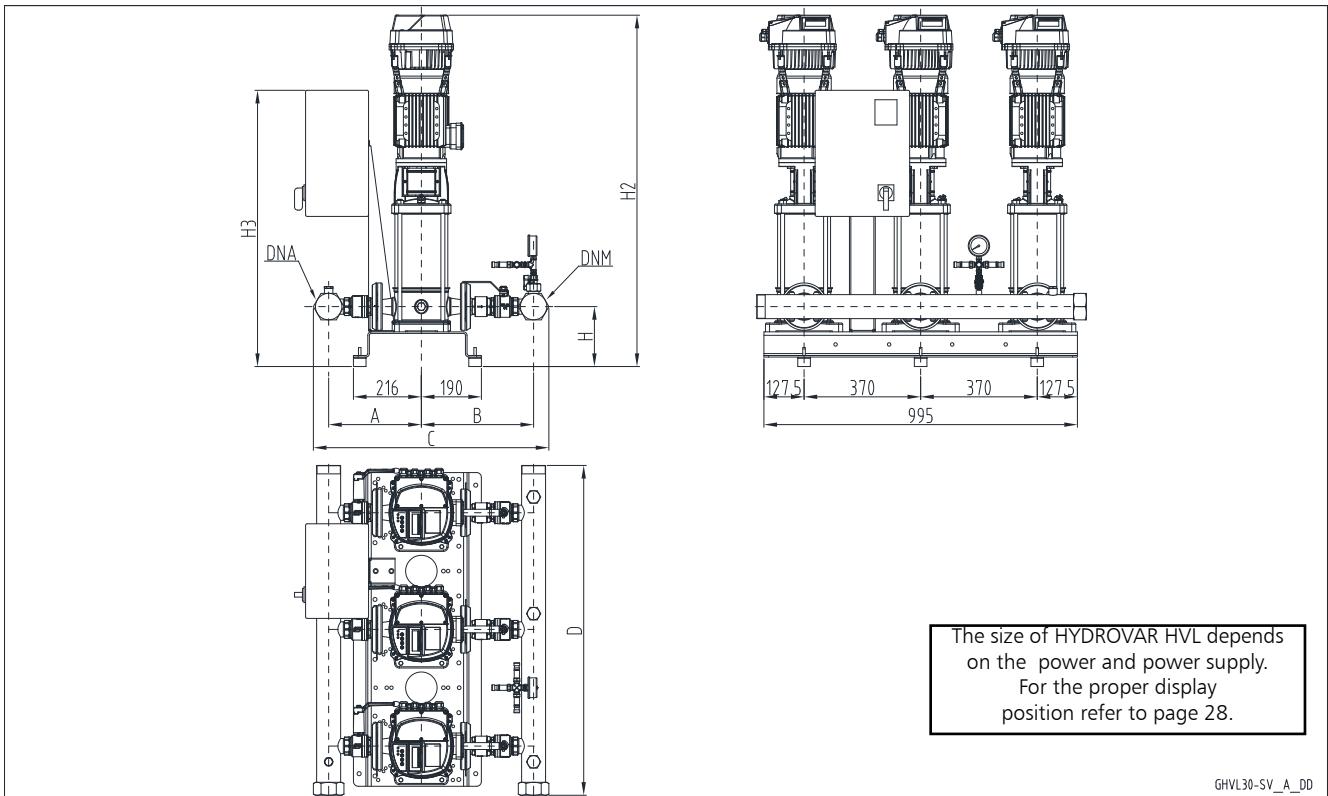

**GHV30**

GHV 30	DNA	DNM	A		B		C		D	H	H2	H3
			STD	AISI	STD	AISI	STD	AISI				
5SV03F005T	R 2"	R 2"	260	267	329	387	649	714	1040	185	804	876
5SV04F005T	R 2"	R 2"	260	267	329	387	649	714	1040	185	829	876
5SV05F007T	R 2"	R 2"	260	267	329	387	649	714	1040	185	896	876
5SV06F011T	R 2"	R 2"	260	267	329	387	649	714	1040	185	921	876
5SV07F011T	R 2"	R 2"	260	267	329	387	649	714	1040	185	946	876
5SV08F011T	R 2"	R 2"	260	267	329	387	649	714	1040	185	971	876
5SV09F015T	R 2"	R 2"	260	267	329	387	649	714	1040	185	1006	876
5SV10F015T	R 2"	R 2"	260	267	329	387	649	714	1040	185	1031	876
5SV11F015T	R 2"	R 2"	260	267	329	387	649	714	1040	185	1056	876
5SV12F022T	R 2"	R 2"	260	267	329	387	649	714	1040	185	1116	876
5SV13F022T	R 2"	R 2"	260	267	329	387	649	714	1040	185	1141	876
5SV14F022T	R 2"	R 2"	260	267	329	387	649	714	1040	185	1166	876
5SV15F022T	R 2"	R 2"	260	267	329	387	649	714	1040	185	1191	876
5SV16F022T	R 2"	R 2"	260	267	329	387	649	714	1040	185	1216	876
5SV18F030T	R 2"	R 2"	260	267	329	387	649	714	1040	185	1276	876
5SV21F030T	R 2"	R 2"	260	267	329	387	649	714	1040	185	1351	876
10SV01F007T	R 2"1/2	R 2"1/2	294	301	356	453	726	830	1040	190	900	876
10SV02F007T	R 2"1/2	R 2"1/2	294	301	356	453	726	830	1040	190	900	876
10SV03F011T	R 2"1/2	R 2"1/2	294	301	356	453	726	830	1040	190	932	876
10SV04F015T	R 2"1/2	R 2"1/2	294	301	356	453	726	830	1040	190	974	876
10SV05F022T	R 2"1/2	R 2"1/2	294	301	356	453	726	830	1040	190	1041	876
10SV06F022T	R 2"1/2	R 2"1/2	294	301	356	453	726	830	1040	190	1073	876
10SV07F030T	R 2"1/2	R 2"1/2	294	301	356	453	726	830	1040	190	1115	876
10SV08F030T	R 2"1/2	R 2"1/2	294	301	356	453	726	830	1040	190	1147	876
10SV09F040T	R 2"1/2	R 2"1/2	294	301	356	453	726	830	1040	190	1200	876
10SV10F040T	R 2"1/2	R 2"1/2	294	301	356	453	726	830	1040	190	1232	876
10SV11F040T	R 2"1/2	R 2"1/2	294	301	356	453	726	830	1040	190	1264	876
10SV13F055T	R 2"1/2	R 2"1/2	294	301	356	453	726	830	1040	190	1466	876

Dimensions in mm. Tolerance ± 10 mm.  
AISI: same dimensions /A304, /A316

ghv30\_10esv\_d\_td

### SET OF 3 PUMPS THREE-PHASE POWER SUPPLY (GHV30.../4)

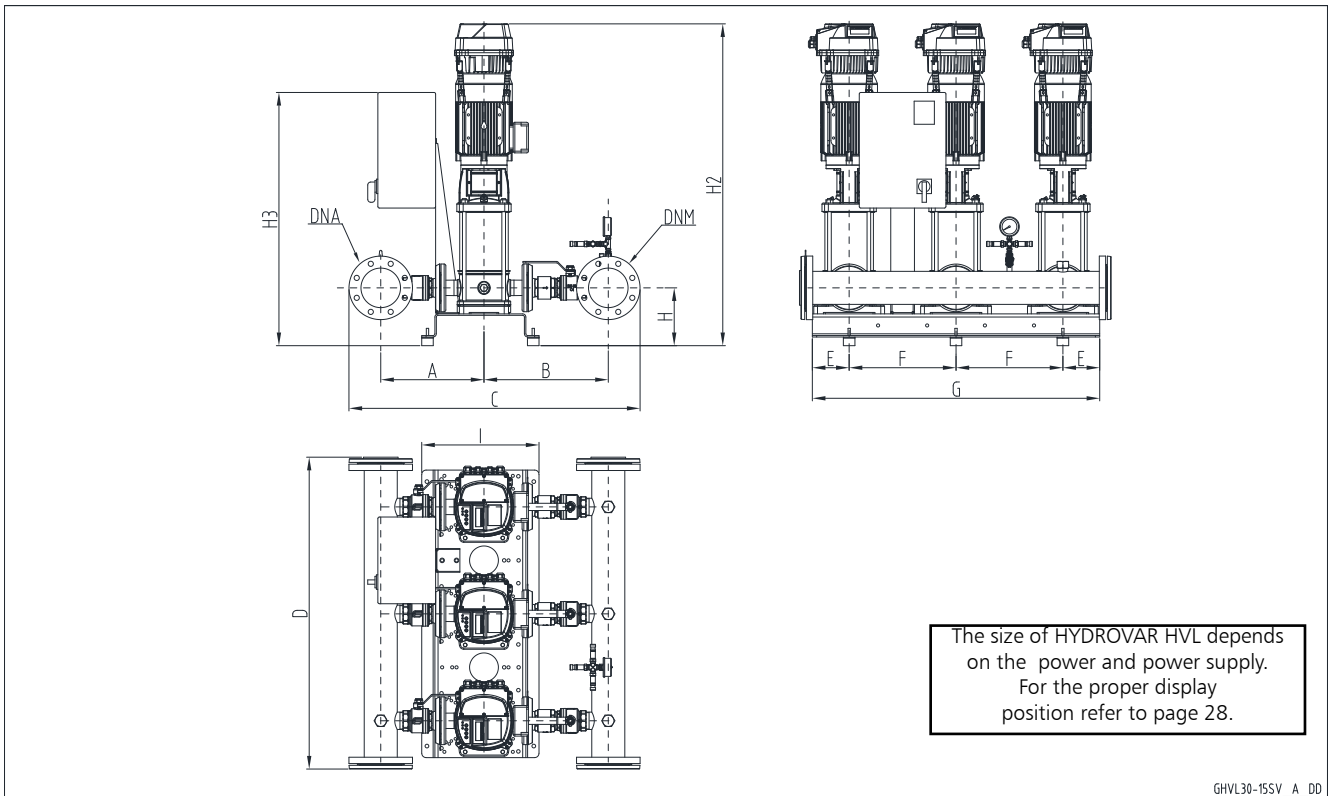

GHV30-15SV\_A\_DD

**GHV30**

GHV 30	DNA	DNM	A		B		C		D	E	F	G	H	H2	H3	I
			STD	AISI	STD	AISI	STD	AISI								
15SV01F011T	100	80	357	363	418	409	985	982	1084	128	370	995	200	942	876	406
15SV02F022T	100	80	357	363	418	409	985	982	1084	128	370	995	200	987	876	406
15SV03F030T	100	80	357	363	418	409	985	982	1084	128	370	995	200	1045	876	406
15SV04F040T	100	80	357	363	418	409	985	982	1084	128	370	995	200	1114	876	406
15SV05F040T	100	80	357	363	418	409	985	982	1084	128	370	995	200	1162	876	406
15SV06F055T	100	80	357	363	418	409	985	982	1084	128	370	995	200	1348	876	406
15SV07F055T	100	80	357	363	418	409	985	982	1084	128	370	995	200	1396	876	406
15SV08F075T	100	80	357	363	418	409	985	982	1084	128	370	995	200	1436	876	406
15SV09F075T	100	80	357	363	418	409	985	982	1084	128	370	995	200	1484	876	406
15SV10F110T	100	80	357	363	418	409	985	982	1224	260	440	1400	280	1673	1003	730
22SV01F011T	100	100	357	363	430	421	1007	1004	1084	128	370	995	200	942	876	406
22SV02F022T	100	100	357	363	430	421	1007	1004	1084	128	370	995	200	987	876	406
22SV03F030T	100	100	357	363	430	421	1007	1004	1084	128	370	995	200	1045	876	406
22SV04F040T	100	100	357	363	430	421	1007	1004	1084	128	370	995	200	1114	876	406
22SV05F055T	100	100	357	363	430	421	1007	1004	1084	128	370	995	200	1300	876	406
22SV06F075T	100	100	357	363	430	421	1007	1004	1084	128	370	995	200	1340	876	406
22SV07F075T	100	100	357	363	430	421	1007	1004	1084	128	370	995	200	1388	876	406
22SV08F110T	100	100	357	363	430	421	1007	1004	1224	260	440	1400	280	1577	1003	730
22SV09F110T	100	100	357	363	430	421	1007	1004	1224	260	440	1400	280	1625	1003	730
22SV10F110T	100	100	357	363	430	421	1007	1004	1224	260	440	1400	280	1673	1003	730

Dimensioni in mm. Tolleranza ± 10 mm.

ghv30\_15esv\_g\_td

AISI: same dimensions /A304, /A316

**SET OF 3 PUMPS  
THREE-PHASE POWER SUPPLY (GHV30.../4)**

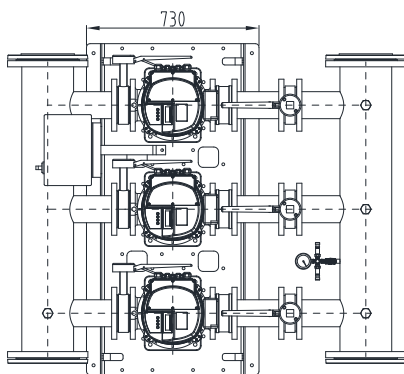
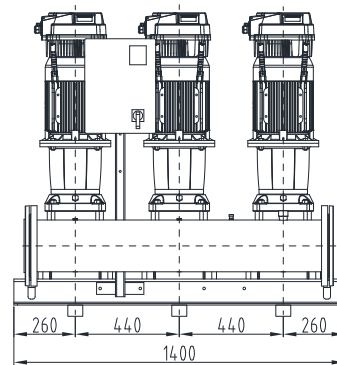
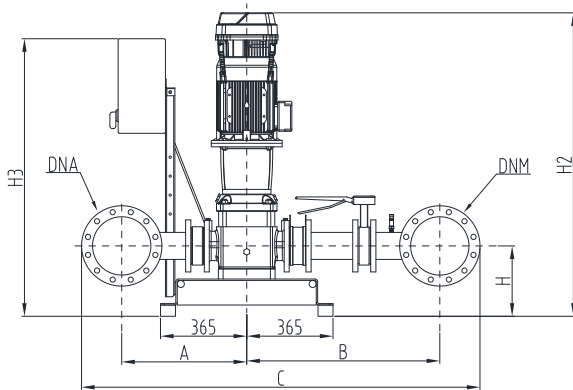

The size of HYDROVAR HVL depends on the power and power supply. For the proper display position refer to page 28.

GHVL30-46SV\_A\_DD

**GHV30**

**SET OF 3 PUMPS  
THREE-PHASE POWER SUPPLY (GHV30.../4)**

GHV 30	DNA	DNM	A	B	C	H	H2	H3
33SV1/1AG022T	125	100	461	713	1409	265	1117	1397
33SV1G030T	125	100	461	713	1409	265	1117	1397
33SV2/2AG040T	125	100	461	713	1409	265	1213	1397
33SV2/1AG040T	125	100	461	713	1409	265	1213	1397
33SV2G055T	125	100	461	713	1409	265	1304	1397
33SV3/2AG055T	125	100	461	713	1409	265	1379	1397
33SV3/1AG075T	125	100	461	713	1409	265	1371	1397
33SV3G075T	125	100	461	713	1409	265	1371	1397
33SV4/2AG075T	125	100	461	713	1409	265	1446	1397
33SV4/1AG110T	125	100	461	713	1423	265	1542	1274
33SV4G110T	125	100	461	713	1423	265	1542	1274
33SV5/2AG110T	125	100	461	713	1423	265	1617	1274
33SV5/1AG110T	125	100	461	713	1423	265	1617	1274
33SV5G150T	125	100	461	713	1423	265	1698	1274
33SV6/2AG150T	125	100	461	713	1423	265	1773	1274
33SV6/1AG150T	125	100	461	713	1423	265	1773	1274
33SV6G150T	125	100	461	713	1423	265	1773	1274
33SV7/2AG150T	125	100	461	713	1423	265	1848	1274
46SV1/1AG030T	150	125	498	752	1517	300	1157	1397
46SV1G040T	150	125	498	752	1517	300	1178	1397
46SV2/2AG055T	150	125	498	752	1517	300	1344	1397
46SV2G075T	150	125	498	752	1517	300	1336	1397
46SV3/2AG110T	150	125	498	752	1517	300	1507	1274
46SV3G110T	150	125	498	752	1517	300	1507	1274
46SV4/2AG150T	150	125	498	752	1517	300	1663	1274
46SV4G150T	150	125	498	752	1517	300	1663	1274
46SV5/2AG185T	150	125	498	752	1517	300	1738	1274
46SV5G185T	150	125	498	752	1517	300	1738	1274
46SV6/2AG220T	150	125	498	752	1517	300	1813	1274
46SV6G220T	150	125	498	752	1517	300	1813	1274
66SV1/1AG040T	200	150	529	794	1635	300	1203	1397
66SV1G055T	200	150	529	794	1635	300	1294	1397
66SV2/2AG075T	200	150	529	794	1635	300	1376	1397
66SV2/1AG110T	200	150	529	794	1635	300	1472	1274
66SV2G110T	200	150	529	794	1635	300	1472	1274
66SV3/2AG150T	200	150	529	794	1635	300	1643	1274
66SV3/1AG150T	200	150	529	794	1635	300	1643	1274
66SV3G185T	200	150	529	794	1635	300	1643	1274
66SV4/2AG185T	200	150	529	794	1635	300	1733	1274
66SV4/1AG220T	200	150	529	794	1635	300	1733	1274
66SV4G220T	200	150	529	794	1635	300	1733	1274
92SV1/1AG055T	200	200	529	819	1688	300	1294	1397
92SV1G075T	200	200	529	819	1688	300	1286	1397
92SV2/2AG110T	200	200	529	819	1688	300	1472	1274
92SV2G150T	200	200	529	819	1688	300	1553	1274
92SV3/2AG185T	200	200	529	819	1688	300	1643	1274
92SV3G220T	200	200	529	819	1688	300	1643	1274

Dimensions in mm. Tolerance  $\pm 10$  mm.  
 AISI: same dimensions /A304, /A316

ghv30\_sv46-en\_e\_td

**GHV30**

**SET OF 3 PUMPS  
THREE-PHASE POWER SUPPLY (GHV30.../4)**

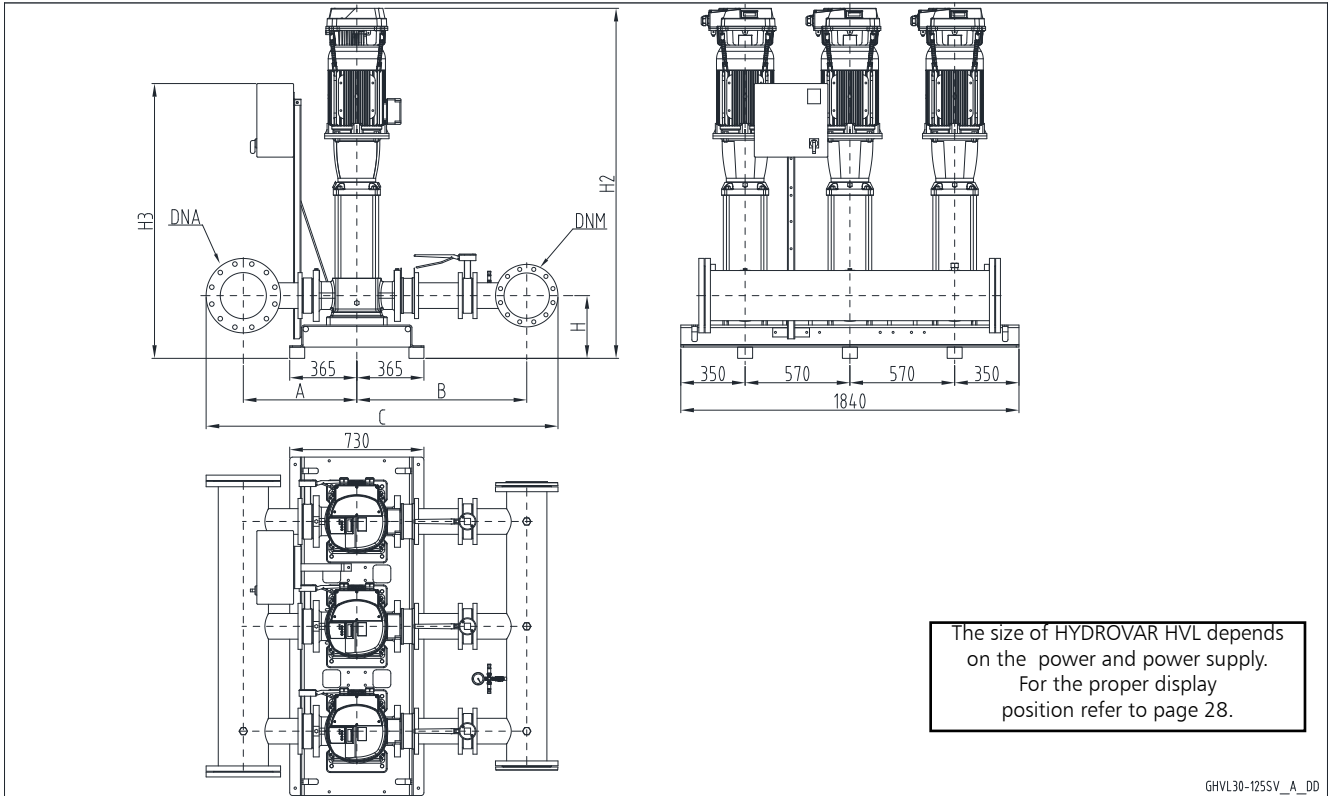

**GHV30**

GHV 30	DNA	DNM	A	B	C	H	H2	H3
125SV1G075T	250	200	618	927	1917	330	1415	1398
125SV2G150T	250	200	618	927	1917	330	1742	1275
125SV3G220T	250	200	618	927	1917	330	1892	1275

Dimensions in mm. Tolerance  $\pm 10$  mm.  
 AISI: same dimensions /A304, /A316

ghv30\_125sv-en\_b\_td

## Booster sets

**MARKET SECTORS**  
RESIDENTIAL-CIVIL, INDUSTRIAL

### APPLICATIONS

- Water network supply in housing complexes, offices, hotels, shopping centres, industrial plants.
- Supply of water networks for agricultural applications (e.g. irrigation)

## GHV40 Series

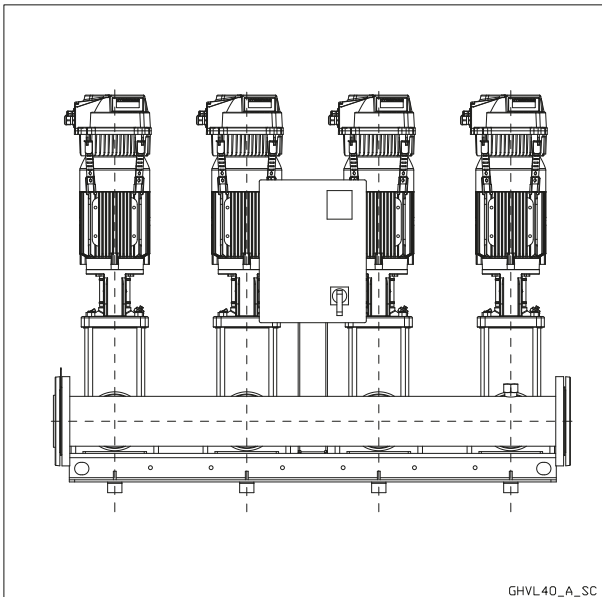

### SPECIFICATIONS

- **Flow rate**  
up to 640 m<sup>3</sup>/h.
- **Head**  
up to 160 m.
- Electrical panel **supply voltage**:  
- single-phase 1 x 230V ± 10% 50/60Hz (GHV.../2)  
- three-phase 3 x 400V ± 10% 50/60Hz (GHV.../4)
- **Frequency** 50Hz
- **e-SV™** vertical axis electric pump
- **HVL** series HYDROVAR®
- **Protection class IP55** for:  
- electrical control panel  
- electrical pump motor  
- HVL converter
- Maximum operating **pressure**:  
16 bar.
- Maximum liquid **temperature**:  
max +80°C.
- Maximum electric pump **power**:  
4 x 22 kW.
- **Progressive** motor start.

**GHV series booster sets with e-SV are certified for use with drinking water according to WRAS and ACS standards, and with Italian Ministry Decree no. 174.**

**SET OF 4 PUMPS  
THREE-PHASE POWER SUPPLY (GHV40.../4)**

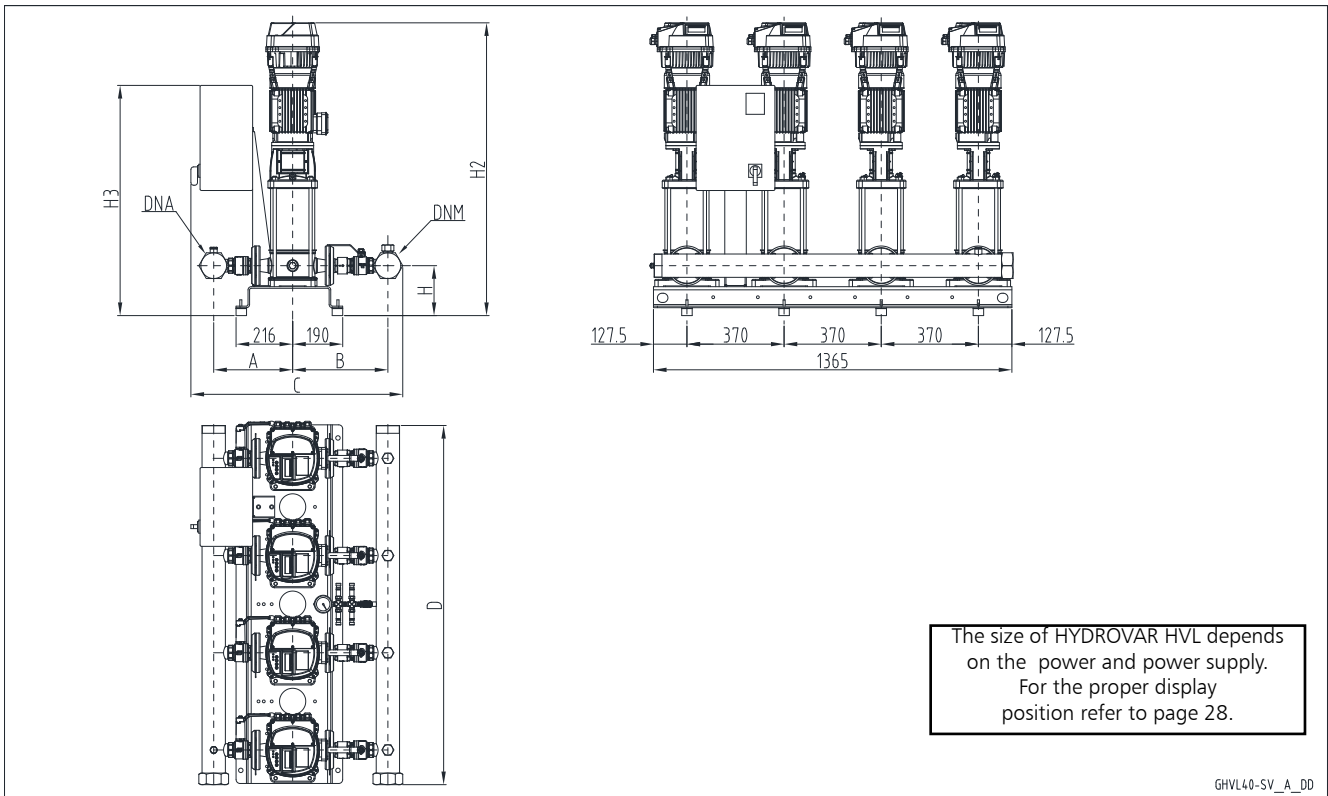

**GHV40**

GHV 40	DNA	DNM	A		B		C		D	H	H2	H3
			STD	AISI	STD	AISI	STD	AISI				
10SV01F007T	R 3"	R 3"	301	308	363	460	752	856	1410	190	900	876
10SV02F007T	R 3"	R 3"	301	308	363	460	752	856	1410	190	900	876
10SV03F011T	R 3"	R 3"	301	308	363	460	752	856	1410	190	932	876
10SV04F015T	R 3"	R 3"	301	308	363	460	752	856	1410	190	974	876
10SV05F022T	R 3"	R 3"	301	308	363	460	752	856	1410	190	1041	876
10SV06F022T	R 3"	R 3"	301	308	363	460	752	856	1410	190	1073	876
10SV07F030T	R 3"	R 3"	301	308	363	460	752	856	1410	190	1115	876
10SV08F030T	R 3"	R 3"	301	308	363	460	752	856	1410	190	1147	876
10SV09F040T	R 3"	R 3"	301	308	363	460	752	856	1410	190	1200	876
10SV10F040T	R 3"	R 3"	301	308	363	460	752	856	1410	190	1232	876
10SV11F040T	R 3"	R 3"	301	308	363	460	752	856	1410	190	1264	876
10SV13F055T	R 3"	R 3"	301	308	363	460	752	856	1410	190	1466	876

Dimensions in mm. Tolerance  $\pm 10$  mm.

ghv40\_10esv-en\_c\_td

AISI: same sizes /A304 /A316



## SET OF 4 PUMPS THREE-PHASE POWER SUPPLY (GHV40.../4)

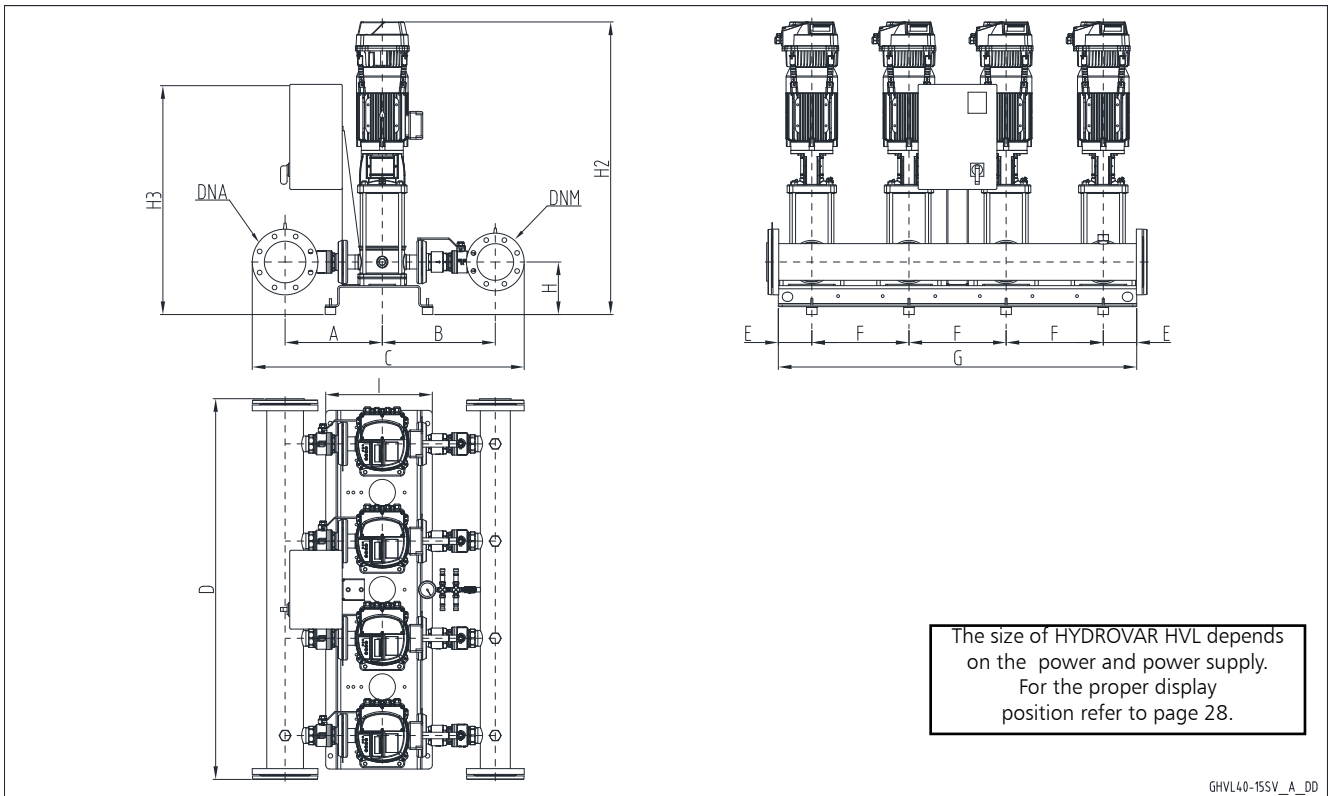

GHV40-15SV\_A\_DD

GHV 40	DNA	DNM	A		B		C		D	E	F	G	H	H2	H3	I
			STD	AISI	STD	AISI	STD	AISI								
15SV01F011T	100	100	357	363	430	421	1007	1004	1454	128	370	1365	200	942	876	406
15SV02F022T	100	100	357	363	430	421	1007	1004	1454	128	370	1365	200	987	876	406
15SV03F030T	100	100	357	363	430	421	1007	1004	1454	128	370	1365	200	1045	876	406
15SV04F040T	100	100	357	363	430	421	1007	1004	1454	128	370	1365	200	1114	876	406
15SV05F040T	100	100	357	363	430	421	1007	1004	1454	128	370	1365	200	1162	876	406
15SV06F055T	100	100	357	363	430	421	1007	1004	1454	128	370	1365	200	1348	876	406
15SV07F055T	100	100	357	363	430	421	1007	1004	1454	128	370	1365	200	1396	876	406
15SV08F075T	100	100	357	363	430	421	1007	1004	1454	128	370	1365	200	1436	1223	406
15SV09F075T	100	100	357	363	430	421	1007	1004	1454	128	370	1365	200	1484	1223	406
15SV10F110T	100	100	357	363	430	421	1007	1004	1664	280	440	1880	250	1673	1243	730
22SV01F011T	125	100	370	376	430	421	1035	1032	1454	128	370	1365	200	942	876	406
22SV02F022T	125	100	370	376	430	421	1035	1032	1454	128	370	1365	200	987	876	406
22SV03F030T	125	100	370	376	430	421	1035	1032	1454	128	370	1365	200	1045	876	406
22SV04F040T	125	100	370	376	430	421	1035	1032	1454	128	370	1365	200	1114	876	406
22SV05F055T	125	100	370	376	430	421	1035	1032	1454	128	370	1365	200	1300	876	406
22SV06F075T	125	100	370	376	430	421	1035	1032	1454	128	370	1365	200	1340	1223	406
22SV07F075T	125	100	370	376	430	421	1035	1032	1454	128	370	1365	200	1388	1223	406
22SV08F110T	125	100	370	376	430	421	1035	1032	1664	280	440	1880	250	1577	1243	730
22SV09F110T	125	100	370	376	430	421	1035	1032	1664	280	440	1880	250	1625	1243	730
22SV10F110T	125	100	370	376	430	421	1035	1032	1664	280	440	1880	250	1673	1243	730

Dimensions in mm. Tolerance  $\pm 10$  mm.

ghv40\_15sev-en\_e\_td

AISI: same sizes /A304 /A316

**GHV40**

**SET OF 4 PUMPS  
THREE-PHASE POWER SUPPLY (GHV40.../4)**

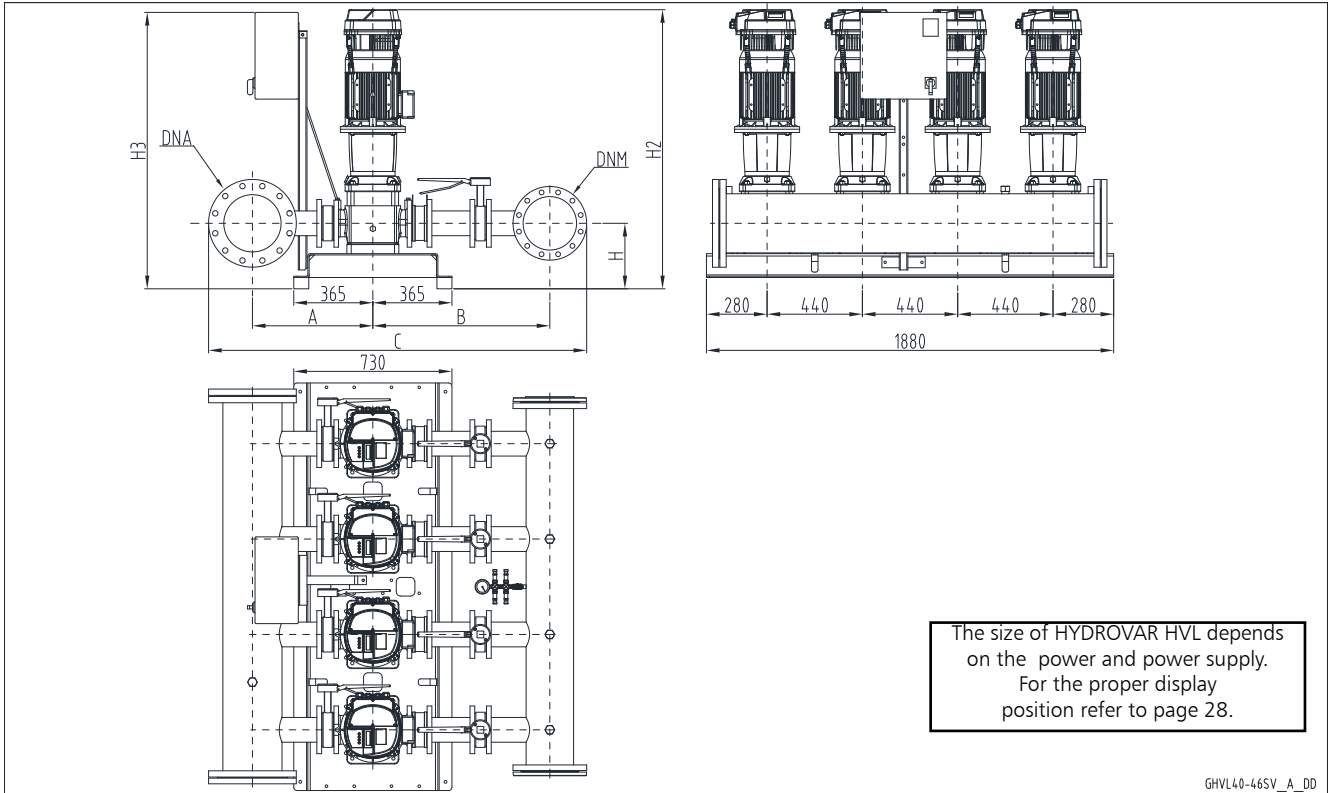

**SET OF 4 PUMPS  
THREE-PHASE POWER SUPPLY (GHV40.../4)**

GHV40	DNA	DNM	A	B	C	H	H2	H3
33SV1/1AG022T	125	125	461	726	1437	265	1117	1397
33SV1G030T	125	125	461	726	1437	265	1117	1397
33SV2/2AG040T	125	125	461	726	1437	265	1213	1397
33SV2/1AG040T	125	125	461	726	1437	265	1213	1397
33SV2G055T	125	125	461	726	1437	265	1304	1397
33SV3/2AG055T	125	125	461	726	1437	265	1379	1397
33SV3/1AG075T	125	125	461	726	1451	265	1371	1274
33SV3G075T	125	125	461	726	1451	265	1371	1274
33SV4/2AG075T	125	125	461	726	1451	265	1446	1274
33SV4/1AG110T	125	125	461	726	1451	265	1542	1274
33SV4G110T	125	125	461	726	1451	265	1542	1274
33SV5/2AG110T	125	125	461	726	1451	265	1617	1274
33SV5/1AG110T	125	125	461	726	1451	265	1617	1274
33SV5G150T	125	125	461	726	1451	265	1698	1274
33SV6/2AG150T	125	125	461	726	1451	265	1773	1274
33SV6/1AG150T	125	125	461	726	1451	265	1773	1274
33SV6G150T	125	125	461	726	1451	265	1773	1274
33SV7/2AG150T	125	125	461	726	1451	265	1848	1274
46SV1/1AG030T	150	150	498	766	1548	300	1157	1397
46SV1G040T	150	150	498	766	1548	300	1178	1397
46SV2/2AG055T	150	150	498	766	1548	300	1344	1397
46SV2G075T	150	150	498	766	1548	300	1336	1274
46SV3/2AG110T	150	150	498	766	1548	300	1507	1274
46SV3G110T	150	150	498	766	1548	300	1507	1274
46SV4/2AG150T	150	150	498	766	1548	300	1663	1274
46SV4G150T	150	150	498	766	1548	300	1663	1274
46SV5/2AG185T	150	150	498	766	1548	300	1738	1201
46SV5G185T	150	150	498	766	1548	300	1738	1201
46SV6/2AG220T	150	150	498	766	1548	300	1813	1201
46SV6G220T	150	150	498	766	1548	300	1813	1201
66SV1/1AG040T	200	200	529	819	1688	300	1203	1397
66SV1G055T	200	200	529	819	1688	300	1294	1397
66SV2/2AG075T	200	200	529	819	1688	300	1376	1274
66SV2/1AG110T	200	200	529	819	1688	300	1472	1274
66SV2G110T	200	200	529	819	1688	300	1472	1274
66SV3/2AG150T	200	200	529	819	1688	300	1643	1274
66SV3/1AG150T	200	200	529	819	1688	300	1643	1274
66SV3G185T	200	200	529	819	1688	300	1643	1201
66SV4/2AG185T	200	200	529	819	1688	300	1733	1201
66SV4/1AG220T	200	200	529	819	1688	300	1733	1201
66SV4G220T	200	200	529	819	1688	300	1733	1201
92SV1/1AG055T	250	200	556	819	1748	300	1294	1397
92SV1G075T	250	200	556	819	1748	300	1286	1274
92SV2/2AG110T	250	200	556	819	1748	300	1472	1274
92SV2G150T	250	200	556	819	1748	300	1553	1274
92SV3/2AG185T	250	200	556	819	1748	300	1643	1201
92SV3G220T	250	200	556	819	1748	300	1643	1201

Dimensions in mm. Tolerance  $\pm 10$  mm.  
 AISI: same dimensions /A304, /A316

ghv40\_sv46-en\_e\_td

**SET OF 4 PUMPS  
THREE-PHASE POWER SUPPLY (GHV40.../4)**

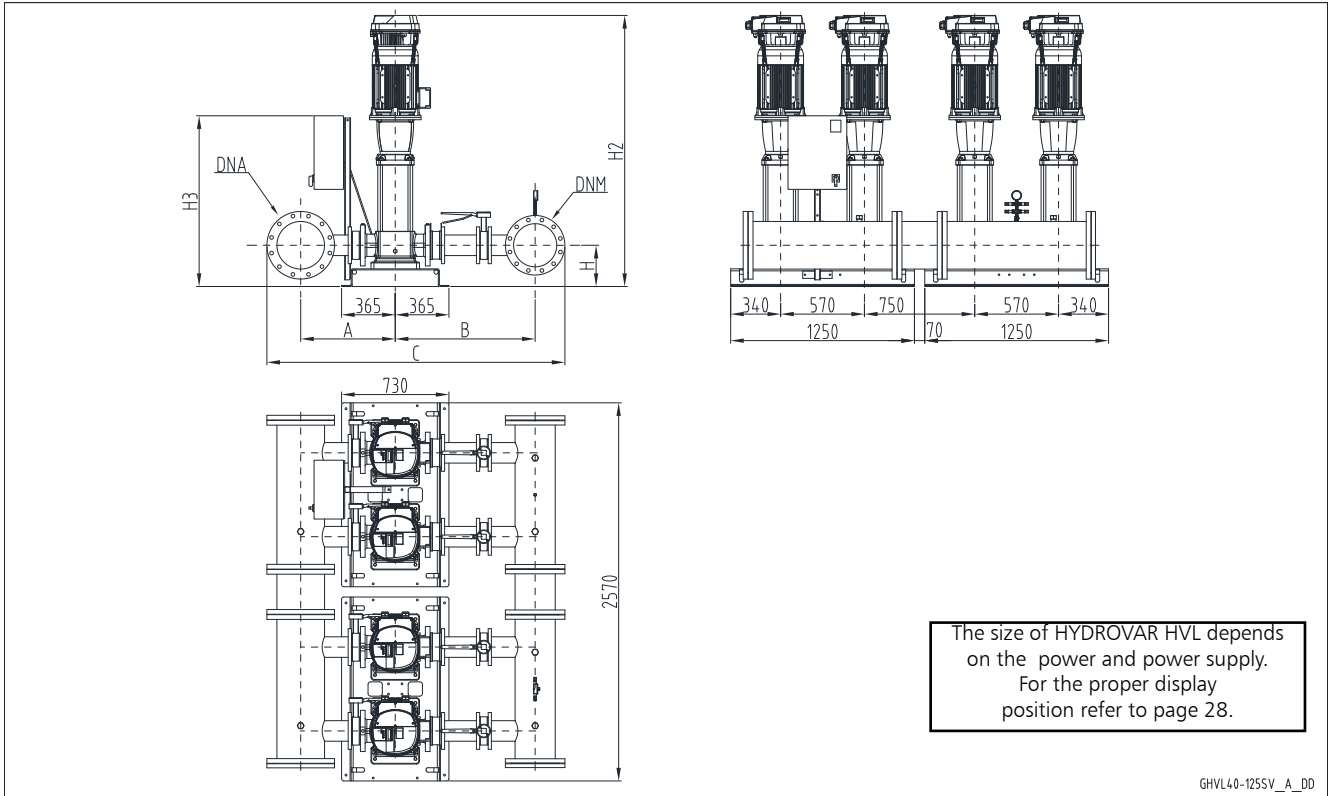

GHVL40-125SV\_A\_DD

**GHV40**

GHV40	DNA	DNM	A	B	C	H	H2	H3
125SV1G075T	300	250	643	954	2029	330	1415	1275
125SV2G150T	300	250	643	954	2029	330	1742	1275
125SV3G220T	300	250	643	954	2029	330	1892	1202

Dimensions in mm. Tolerance  $\pm 10$  mm.  
 AISI: same dimensions /A304, /A316

ghv40\_125sv-en\_b\_td

# PERFORMANCE CURVES

**GHV.../SV BOOSTER SETS SERIES  
OPERATING CHARACTERISTICS AT 30..50 Hz**

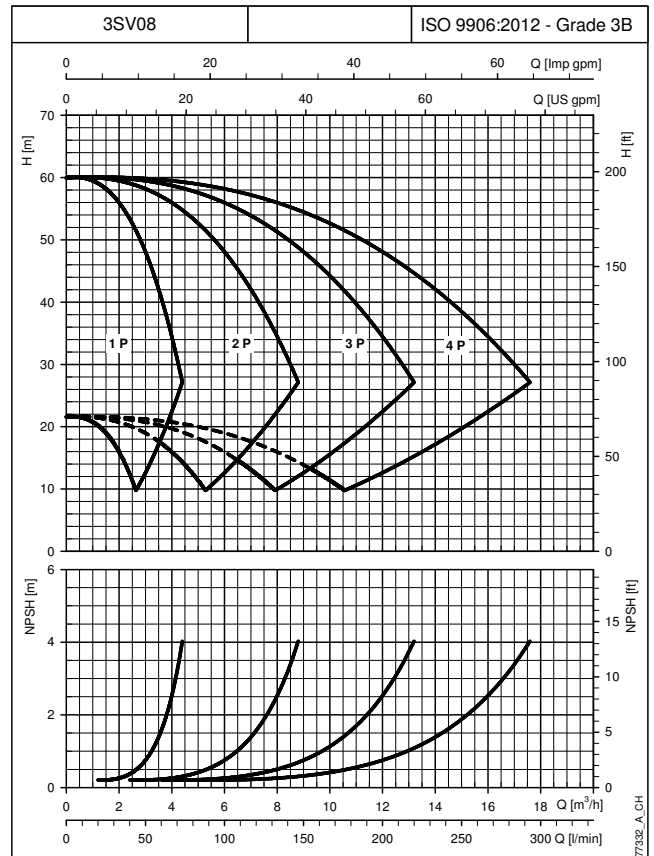
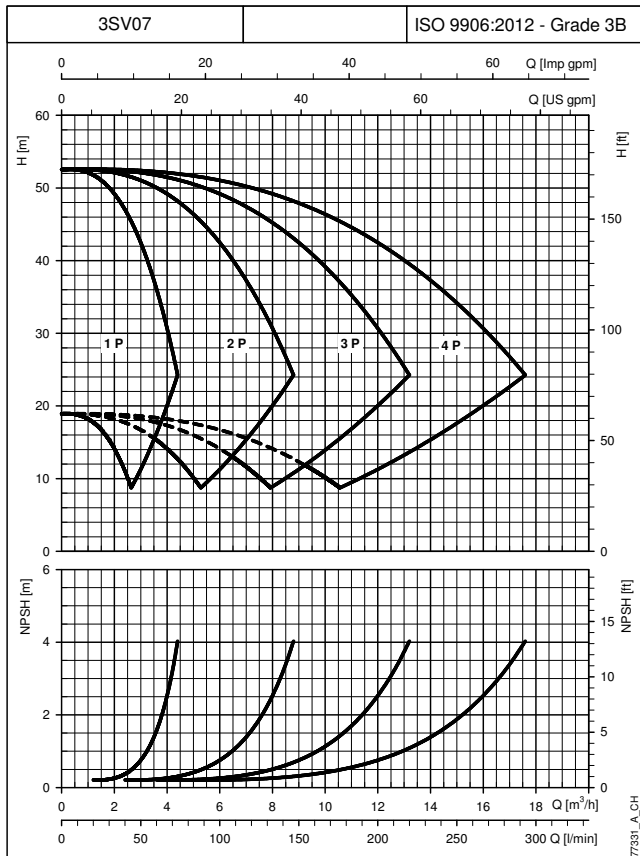
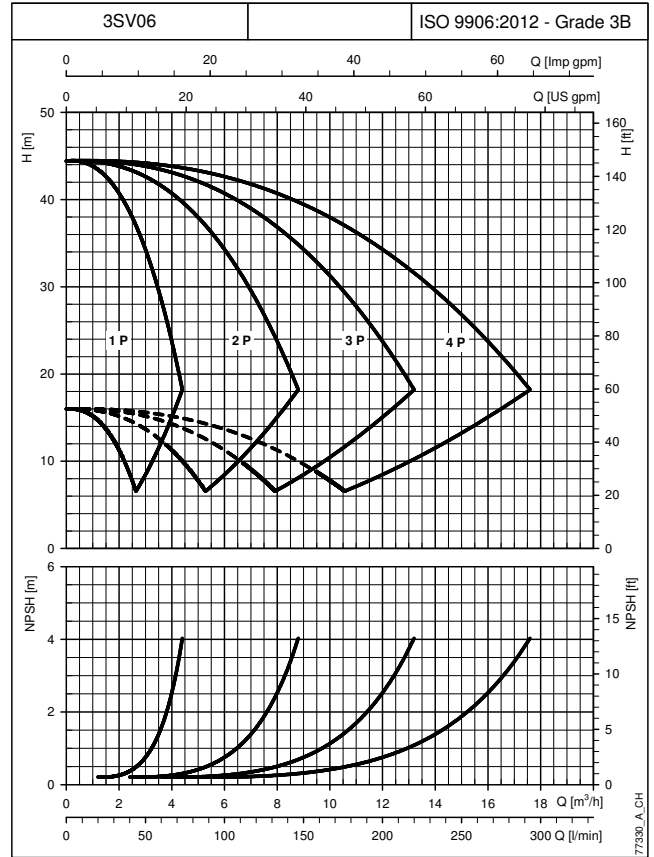
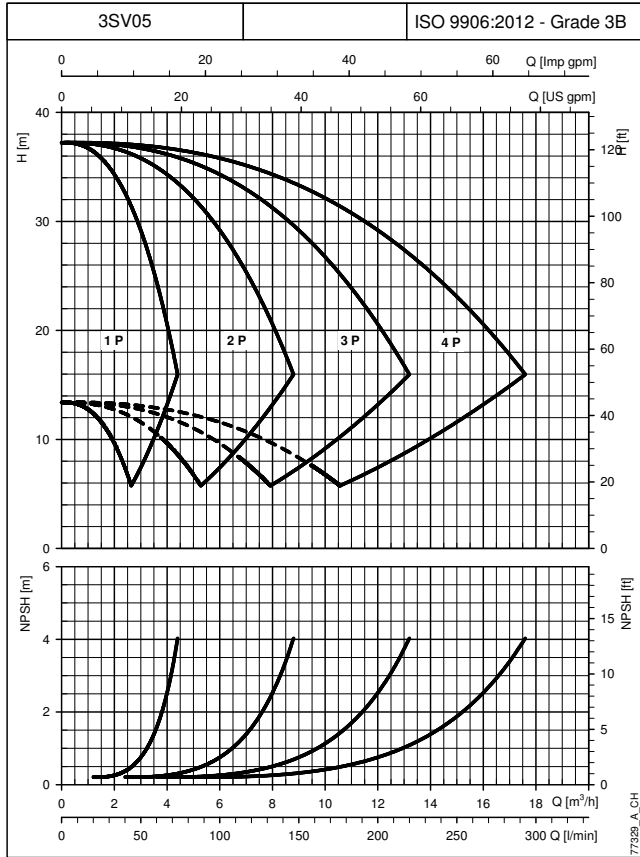

**CURVES**

The performance curves do not take into account flow resistance in the valves and piping. The curves show the performance with one, two, three and four pumps running. These performances are valid for liquids with density  $\rho = 1.0 \text{ Kg/dm}^3$  and kinematic viscosity  $\nu = 1 \text{ mm}^2/\text{sec}$ . The declared NPSH values are laboratory values; for practical use we recommend increasing these values by 0,5 m.

## GHV.../SV BOOSTER SETS SERIES OPERATING CHARACTERISTICS AT 30..50 Hz

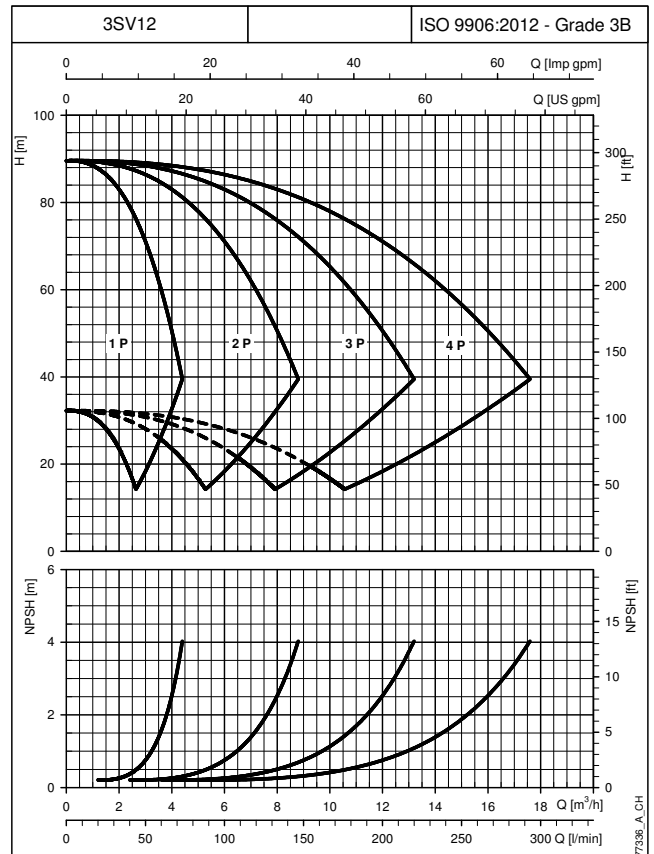
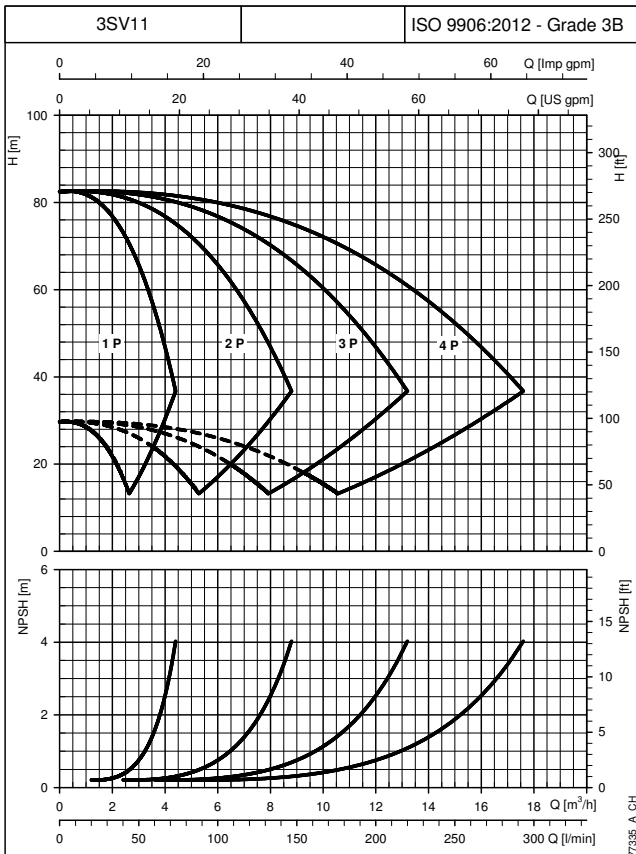
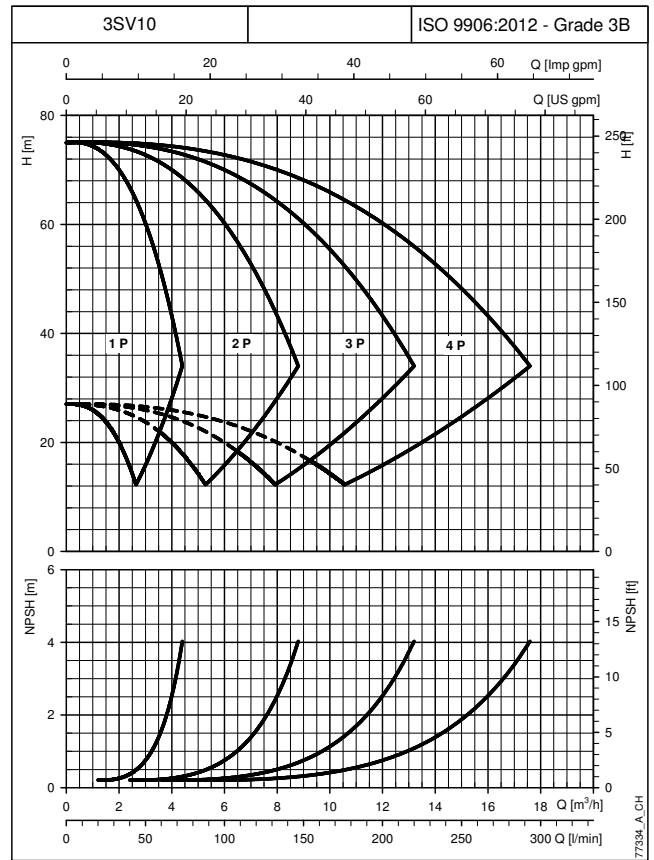
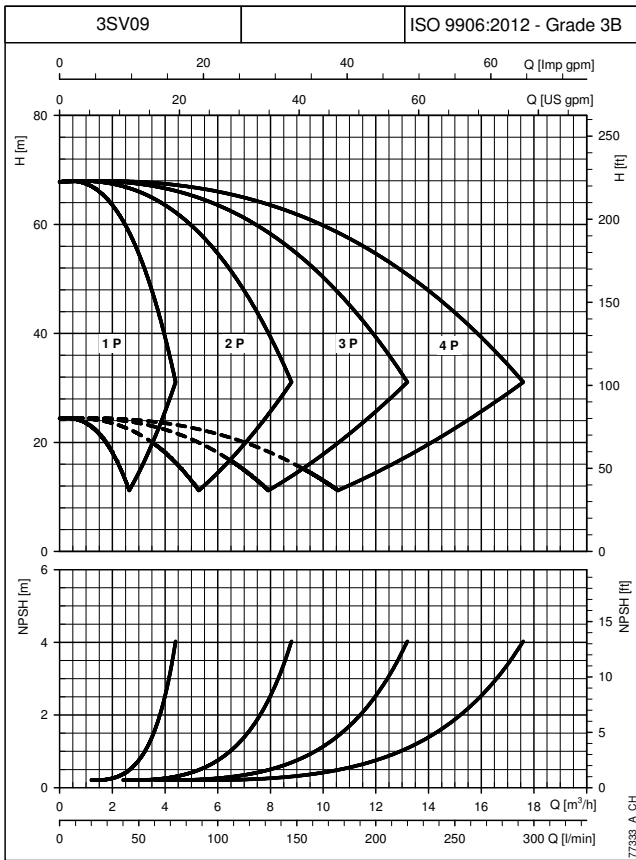

**CURVES**

The performance curves do not take into account flow resistance in the valves and piping. The curves show the performance with one, two, three and four pumps running. These performances are valid for liquids with density  $\rho = 1.0 \text{ Kg/dm}^3$  and kinematic viscosity  $\nu = 1 \text{ mm}^2/\text{sec}$ . The declared NPSH values are laboratory values; for practical use we recommend increasing these values by 0,5 m.

**GHV.../SV BOOSTER SETS SERIES  
OPERATING CHARACTERISTICS AT 30..50 Hz**

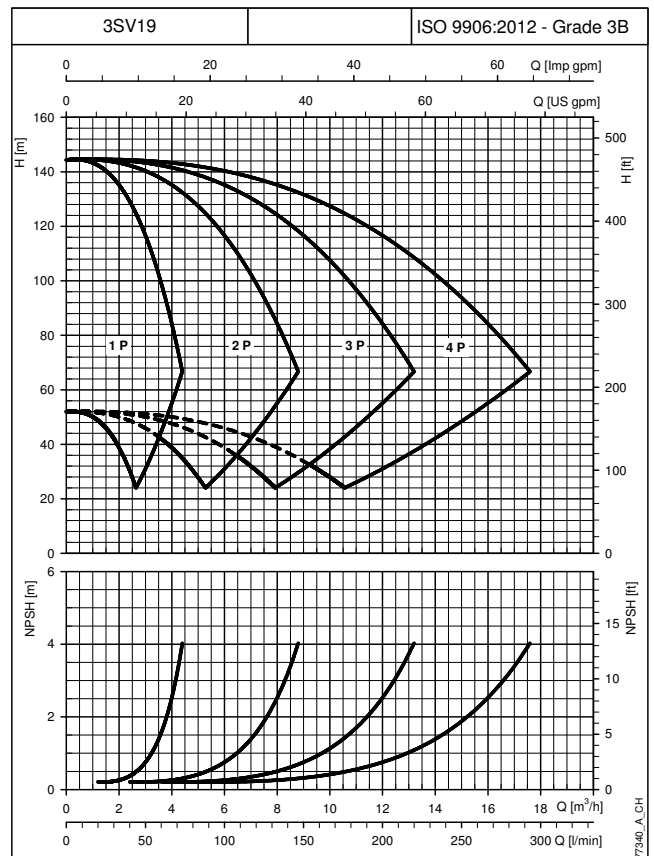
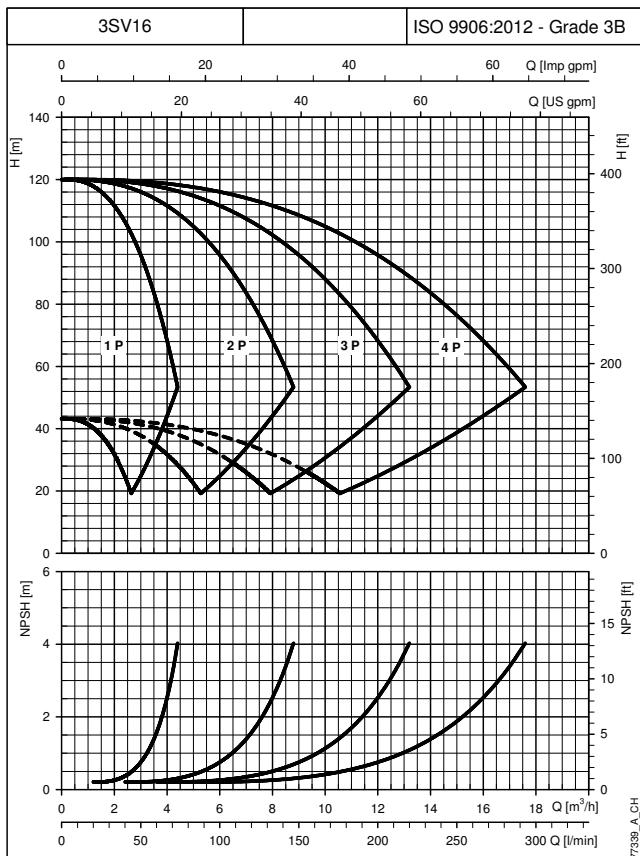
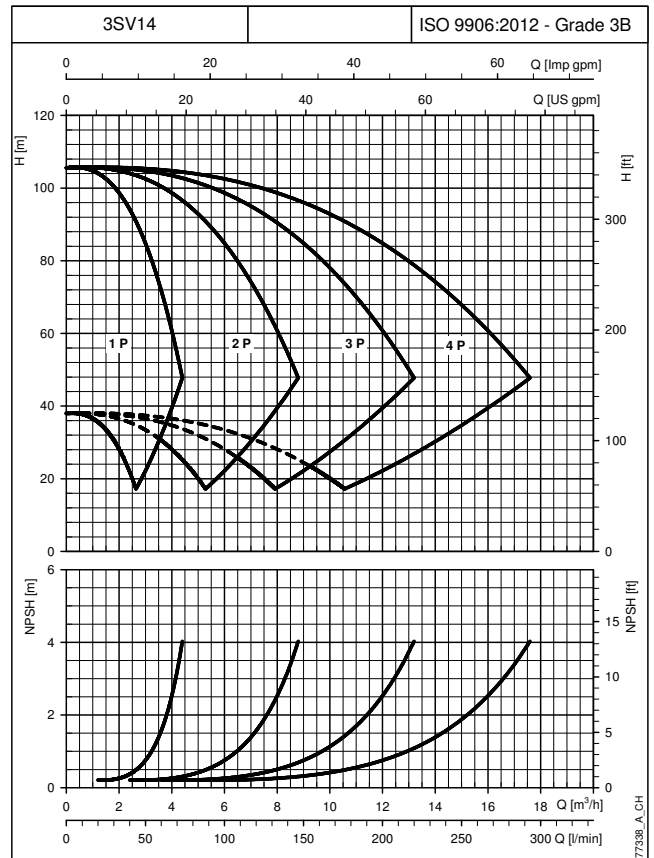
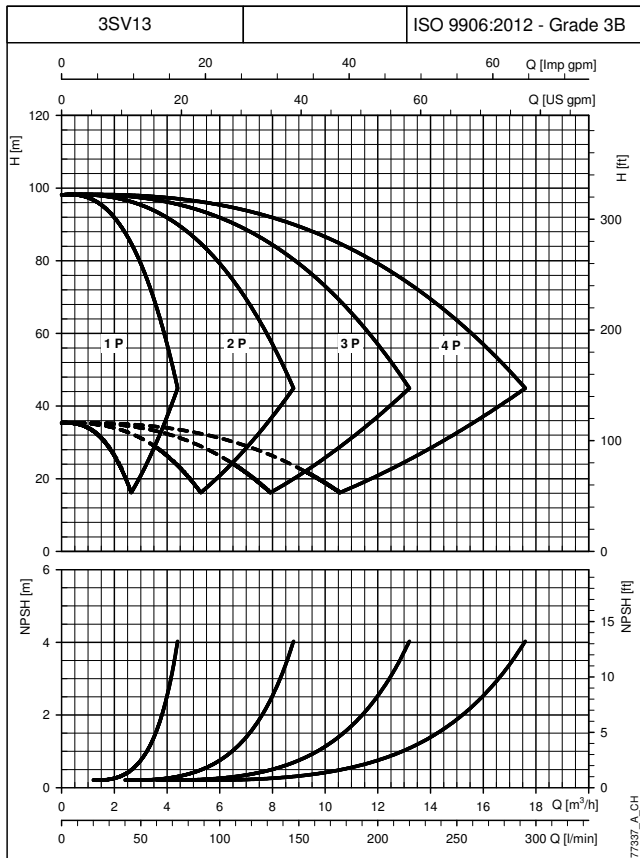

**CURVES**

The performance curves do not take into account flow resistance in the valves and piping. The curves show the performance with one, two, three and four pumps running. These performances are valid for liquids with density  $\rho = 1.0 \text{ Kg/dm}^3$  and kinematic viscosity  $\nu = 1 \text{ mm}^2/\text{sec}$ . The declared NPSH values are laboratory values; for practical use we recommend increasing these values by 0,5 m.



## GHV.../SV BOOSTER SETS SERIES OPERATING CHARACTERISTICS AT 30..50 Hz

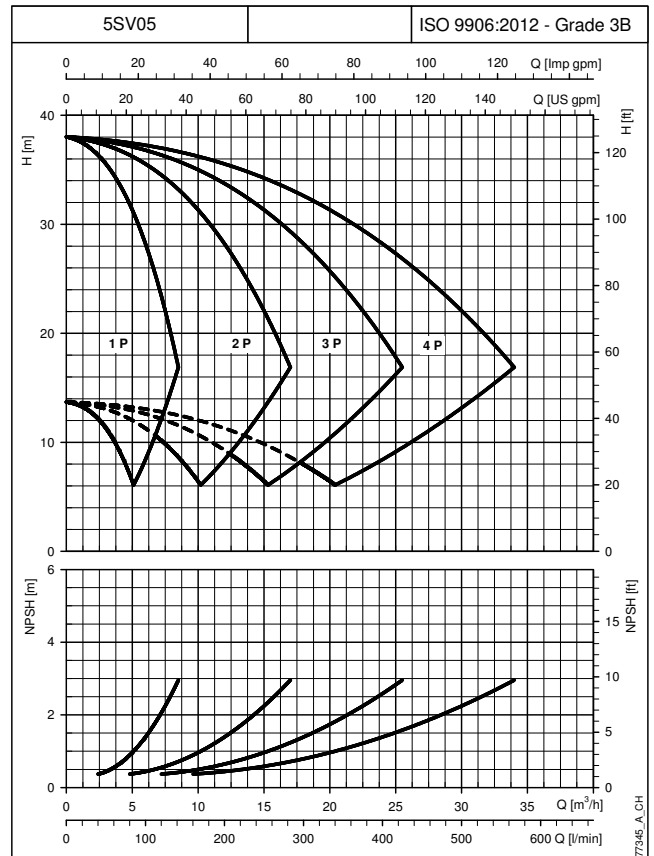
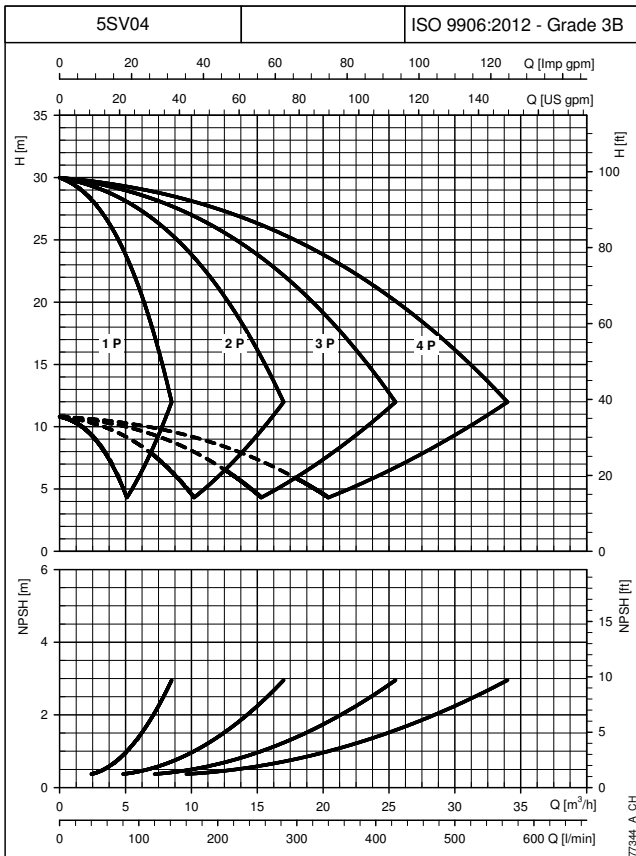
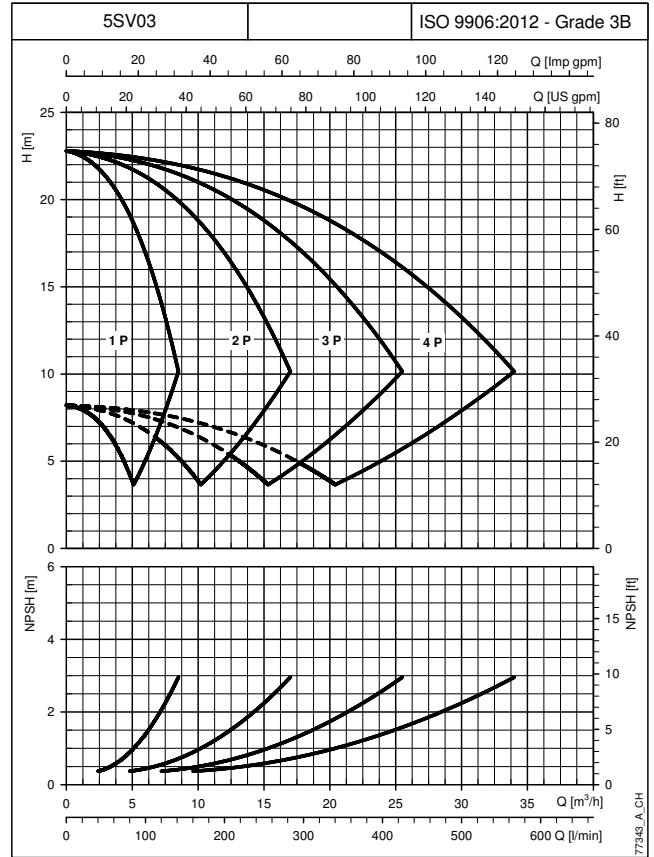
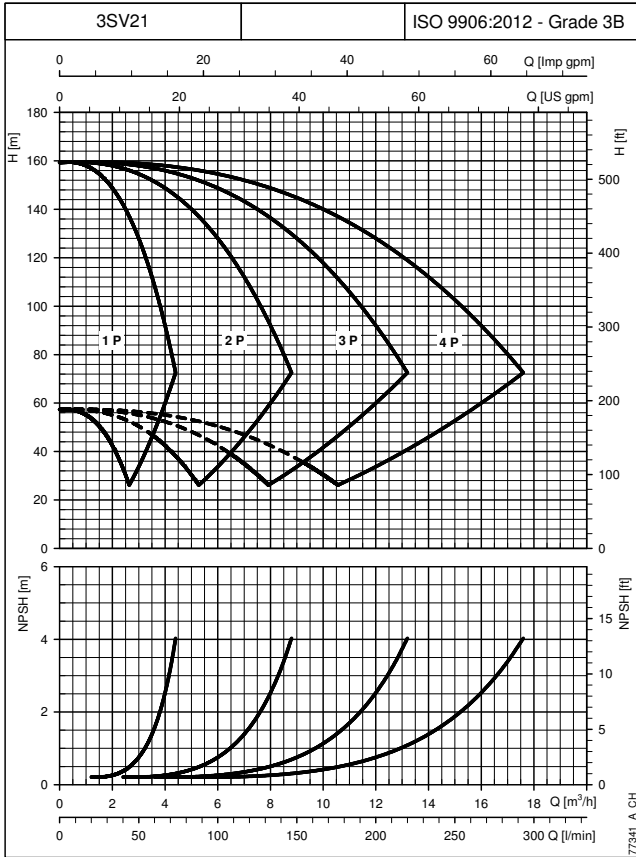

The performance curves do not take into account flow resistance in the valves and piping. The curves show the performance with one, two, three and four pumps running. These performances are valid for liquids with density  $\rho = 1.0 \text{ Kg/dm}^3$  and kinematic viscosity  $\nu = 1 \text{ mm}^2/\text{sec}$ . The declared NPSH values are laboratory values; for practical use we recommend increasing these values by 0,5 m.

**CURVES**

## GHV.../SV BOOSTER SETS SERIES OPERATING CHARACTERISTICS AT 30..50 Hz

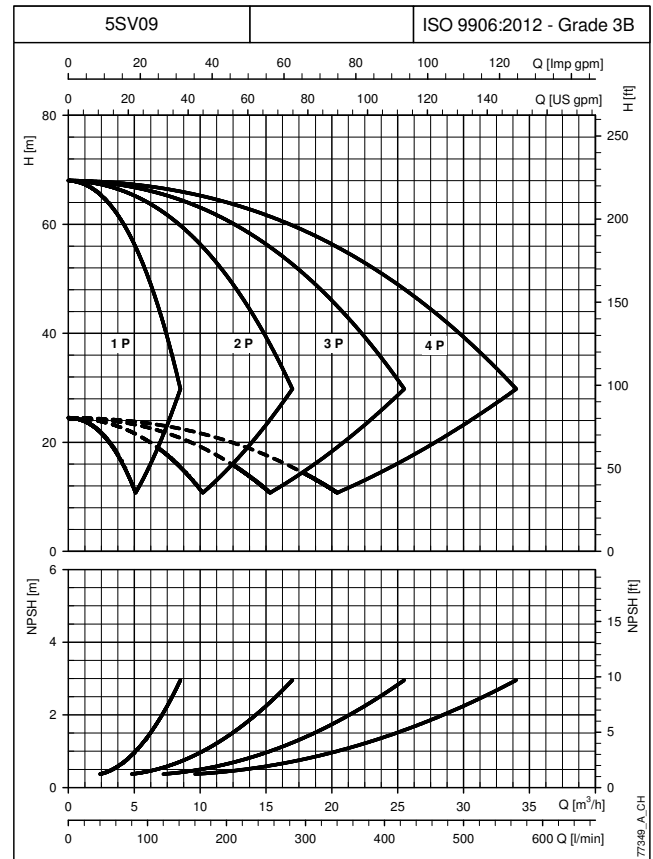
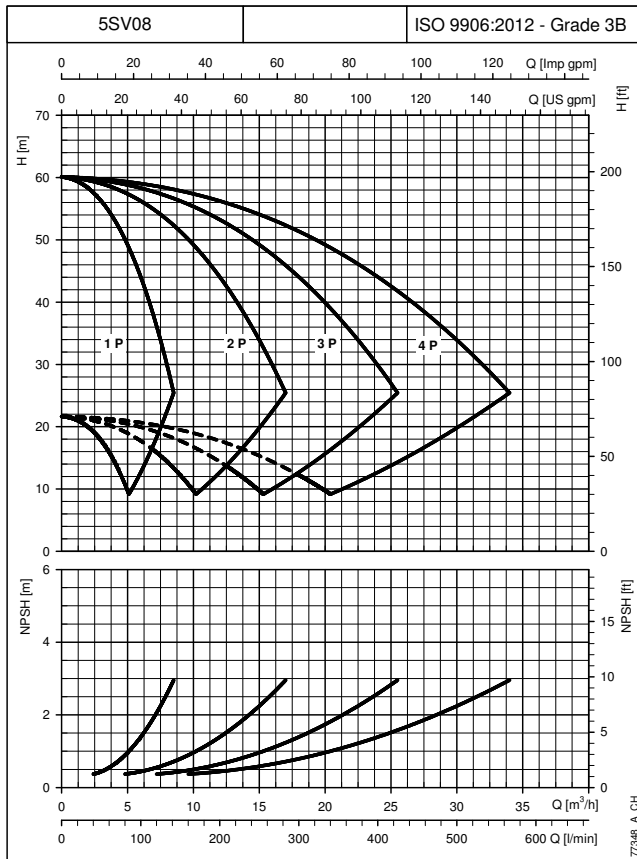
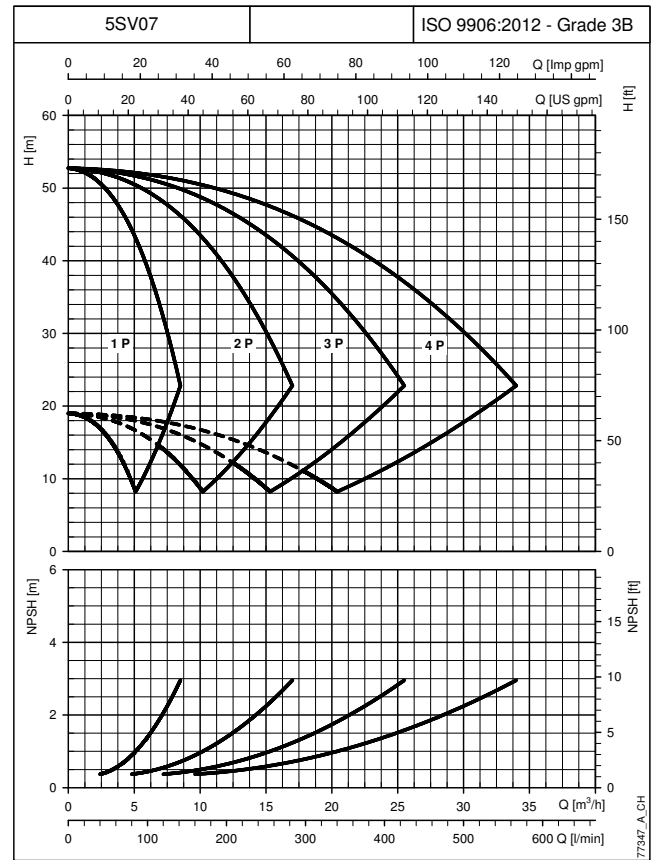
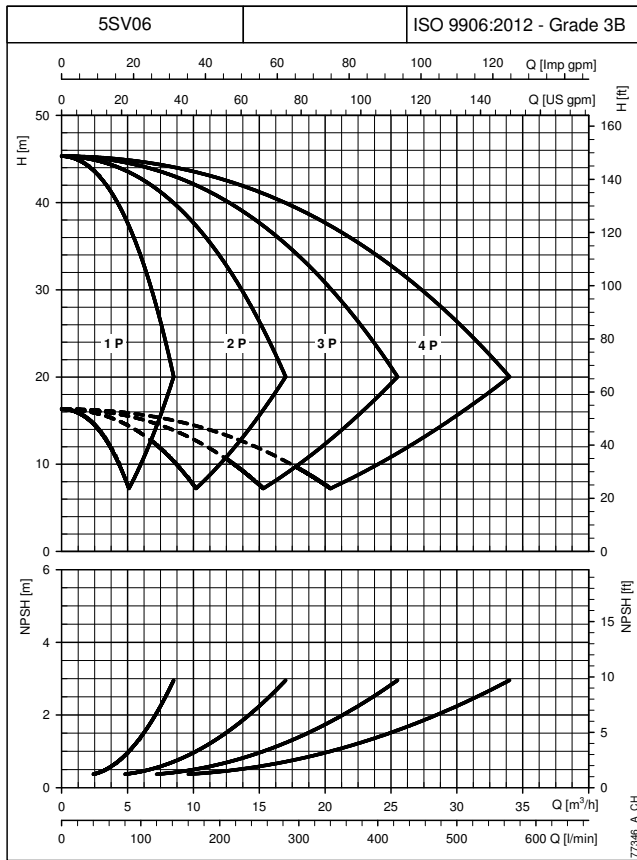

CURVES

The performance curves do not take into account flow resistance in the valves and piping. The curves show the performance with one, two, three and four pumps running. These performances are valid for liquids with density  $\rho = 1.0 \text{ Kg/dm}^3$  and kinematic viscosity  $\nu = 1 \text{ mm}^2/\text{sec}$ . The declared NPSH values are laboratory values; for practical use we recommend increasing these values by 0,5 m.

## GHV.../SV BOOSTER SETS SERIES OPERATING CHARACTERISTICS AT 30..50 Hz

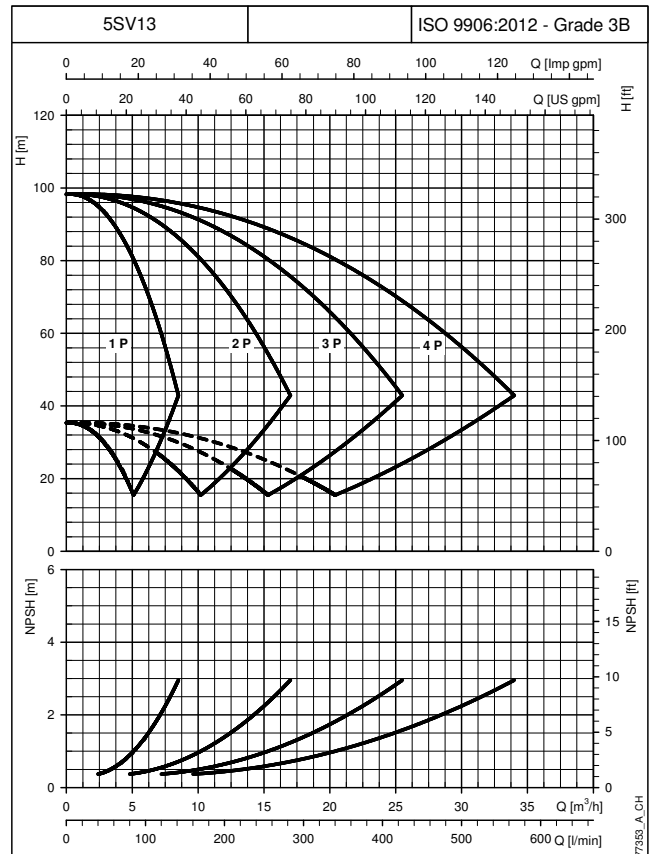
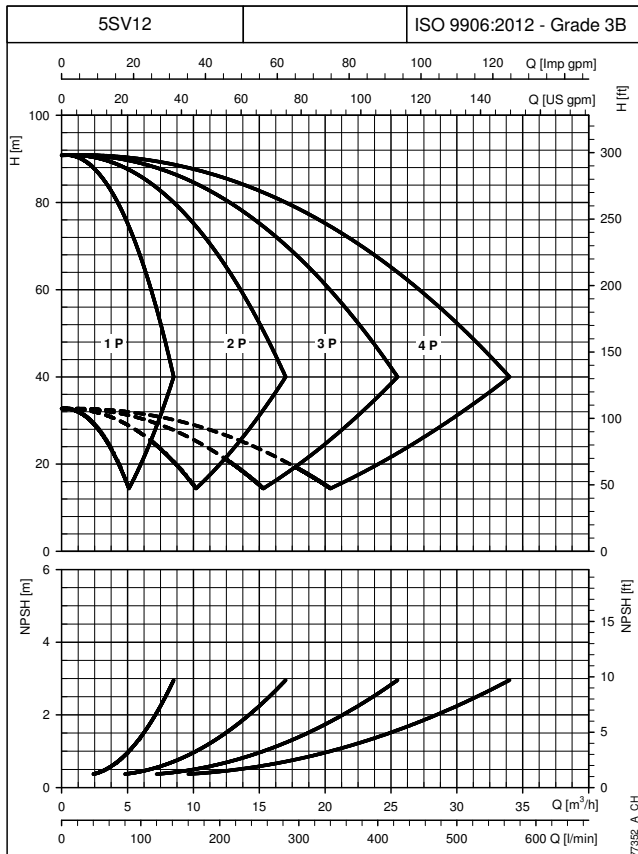
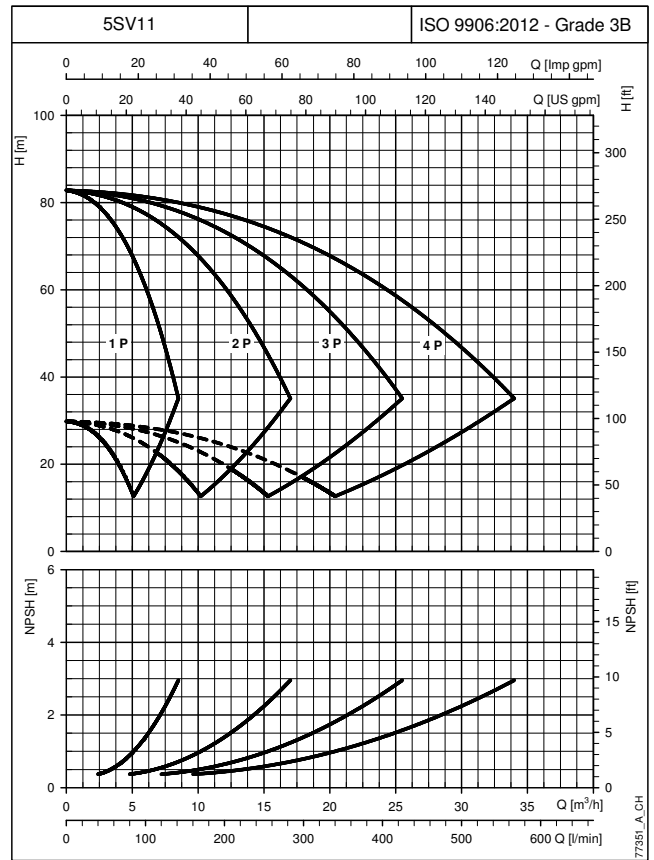
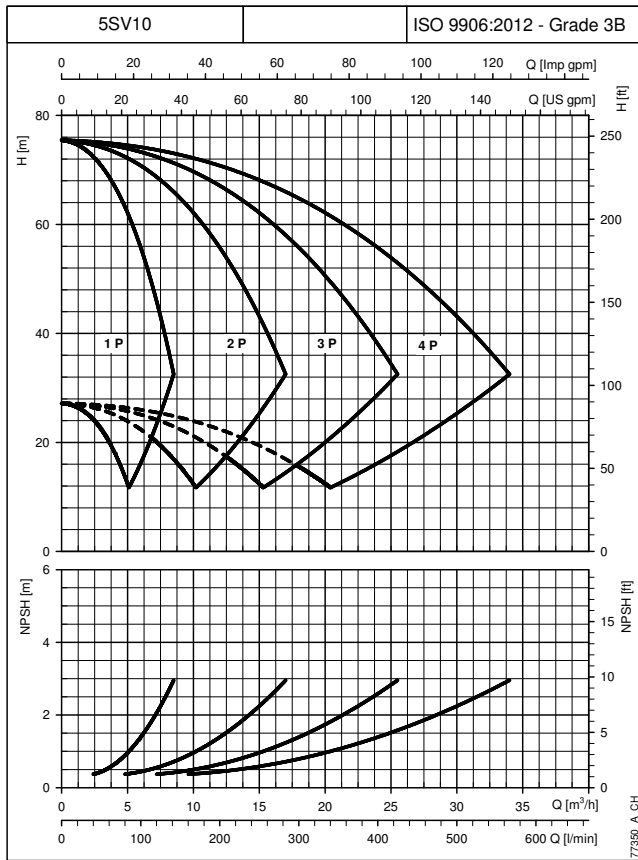

The performance curves do not take into account flow resistance in the valves and piping. The curves show the performance with one, two, three and four pumps running. These performances are valid for liquids with density  $\rho = 1.0 \text{ Kg/dm}^3$  and kinematic viscosity  $\nu = 1 \text{ mm}^2/\text{sec}$ . The declared NPSH values are laboratory values; for practical use we recommend increasing these values by 0,5 m.

**CURVES**

## GHV.../SV BOOSTER SETS SERIES OPERATING CHARACTERISTICS AT 30..50 Hz

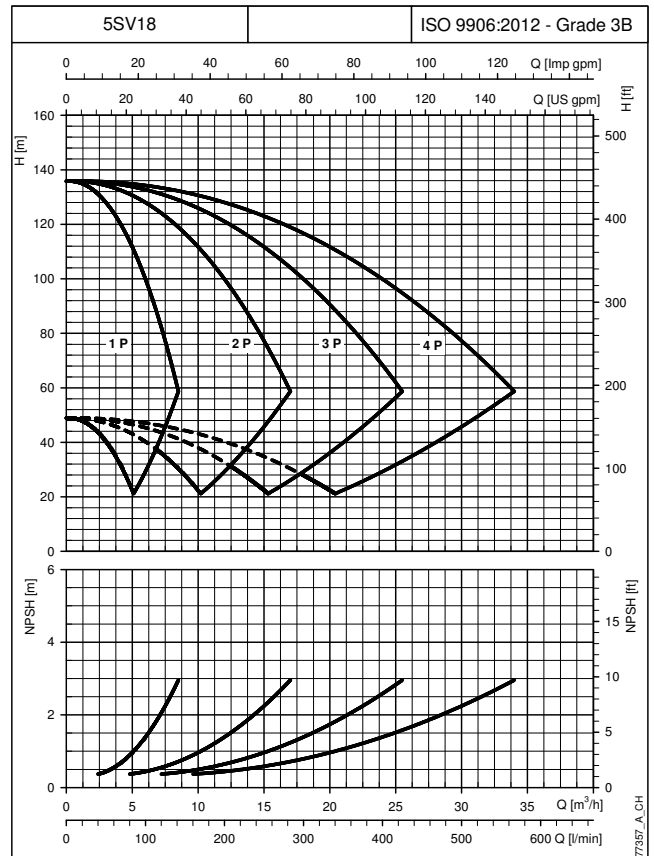
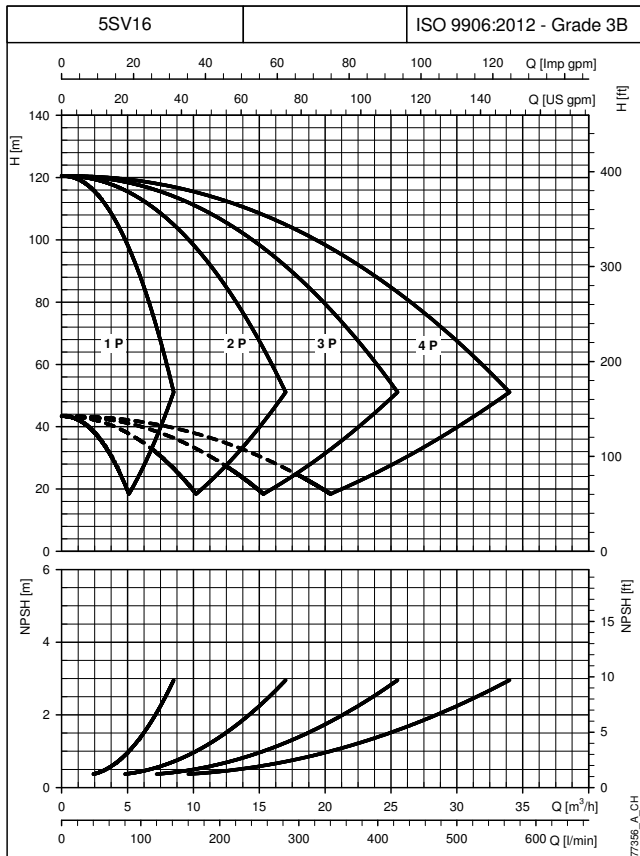
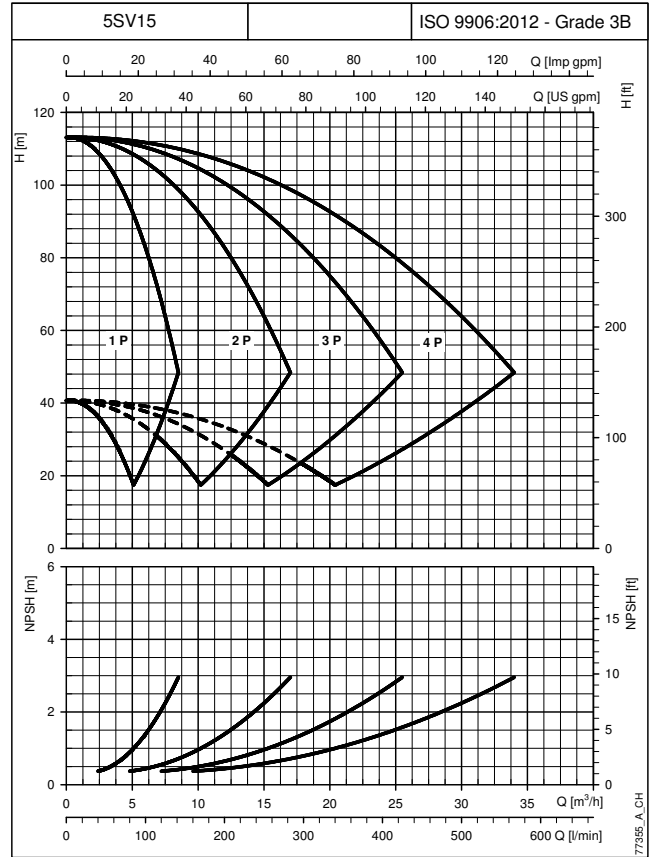
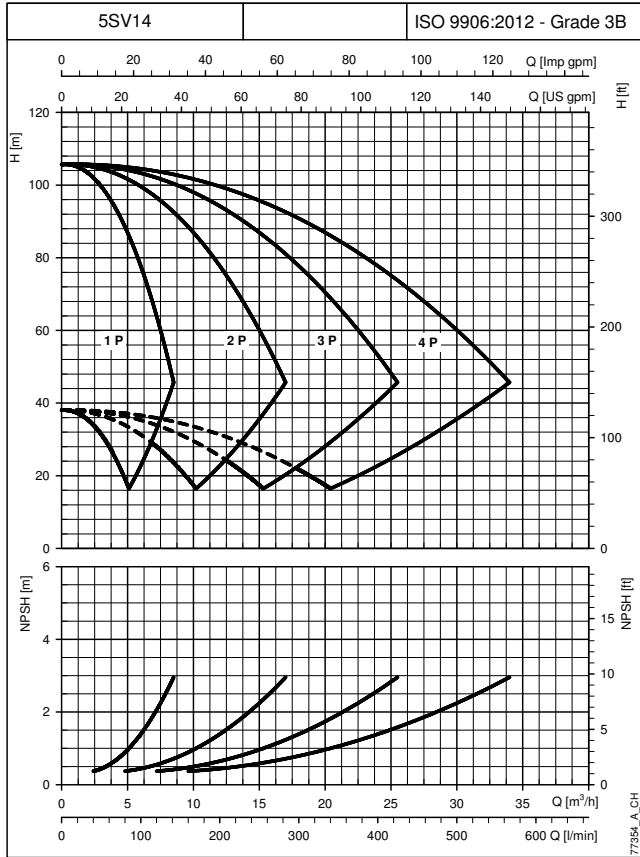

**CURVES**

The performance curves do not take into account flow resistance in the valves and piping. The curves show the performance with one, two, three and four pumps running. These performances are valid for liquids with density  $\rho = 1.0 \text{ Kg/dm}^3$  and kinematic viscosity  $\nu = 1 \text{ mm}^2/\text{sec}$ . The declared NPSH values are laboratory values; for practical use we recommend increasing these values by 0,5 m.

## GHV.../SV BOOSTER SETS SERIES OPERATING CHARACTERISTICS AT 30..50 Hz

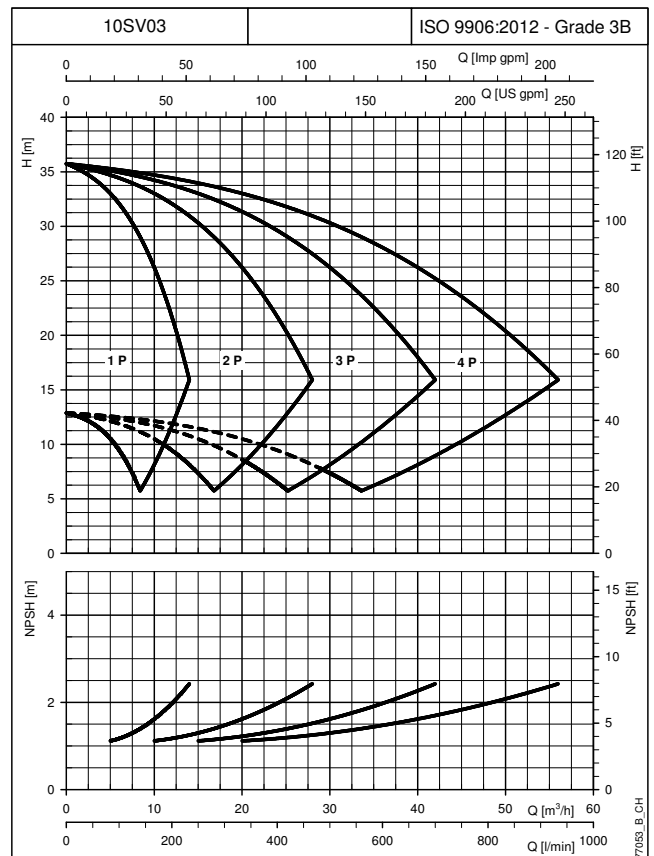
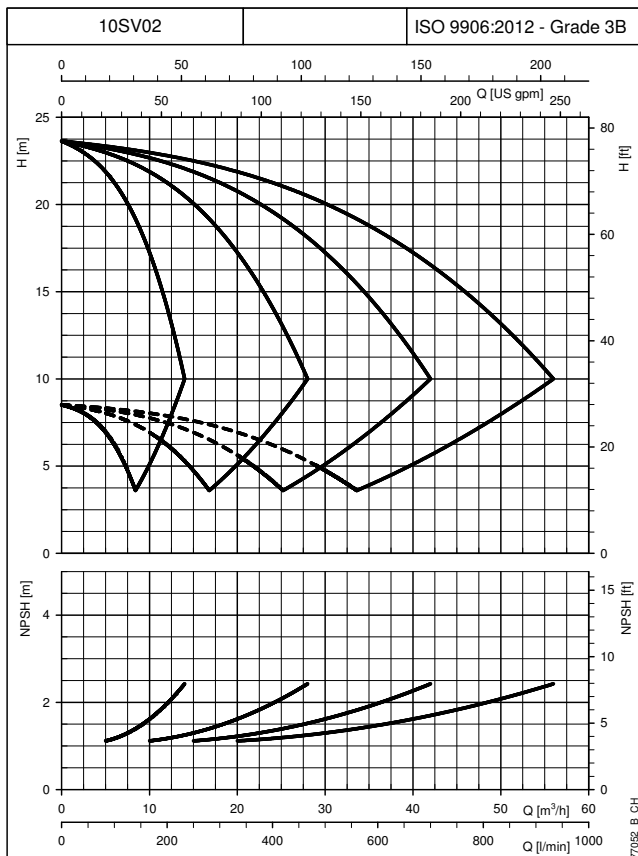
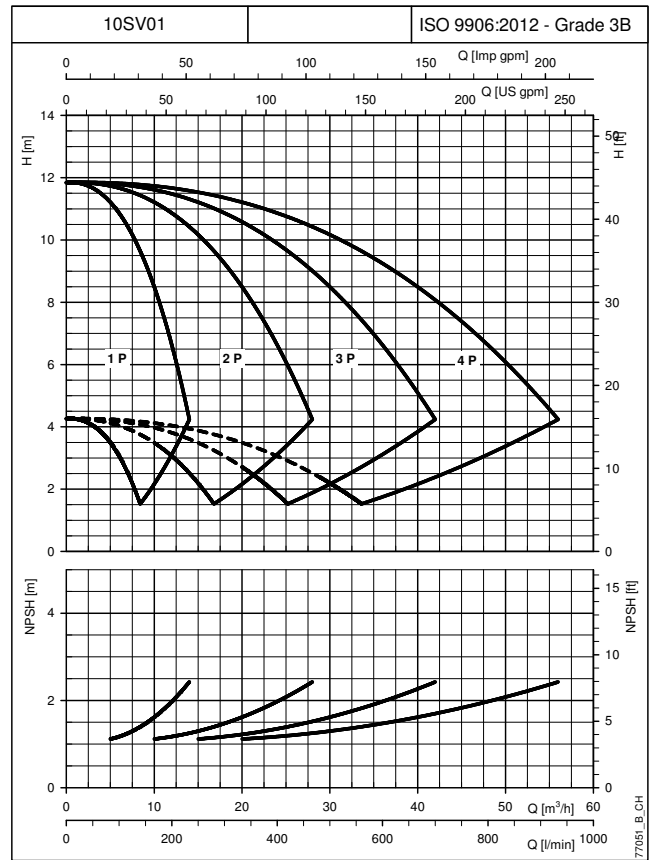
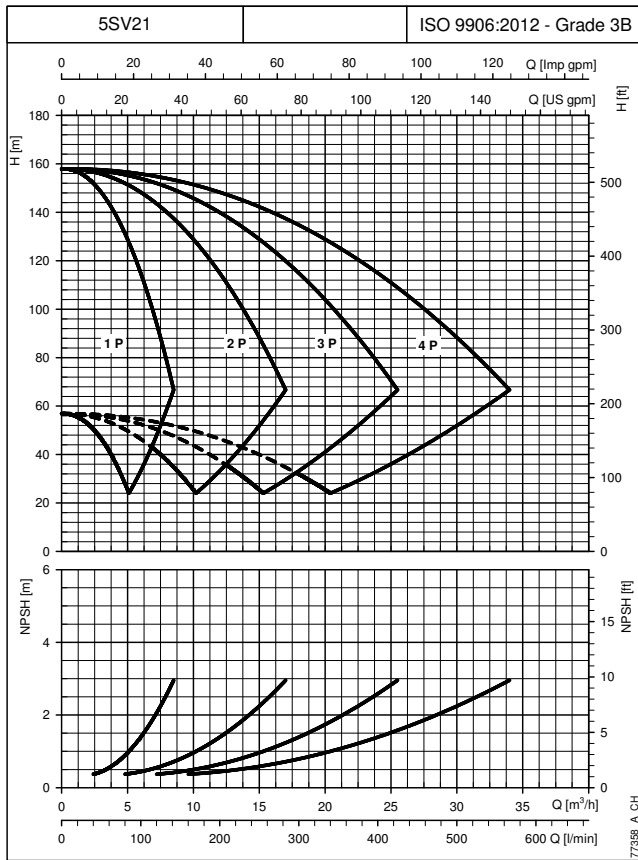

The performance curves do not take into account flow resistance in the valves and piping. The curves show the performance with one, two, three and four pumps running. These performances are valid for liquids with density  $\rho = 1.0 \text{ Kg/dm}^3$  and kinematic viscosity  $\nu = 1 \text{ mm}^2/\text{sec}$ . The declared NPSH values are laboratory values; for practical use we recommend increasing these values by 0,5 m.

**CURVES**

## GHV.../SV BOOSTER SETS SERIES OPERATING CHARACTERISTICS AT 30..50 Hz

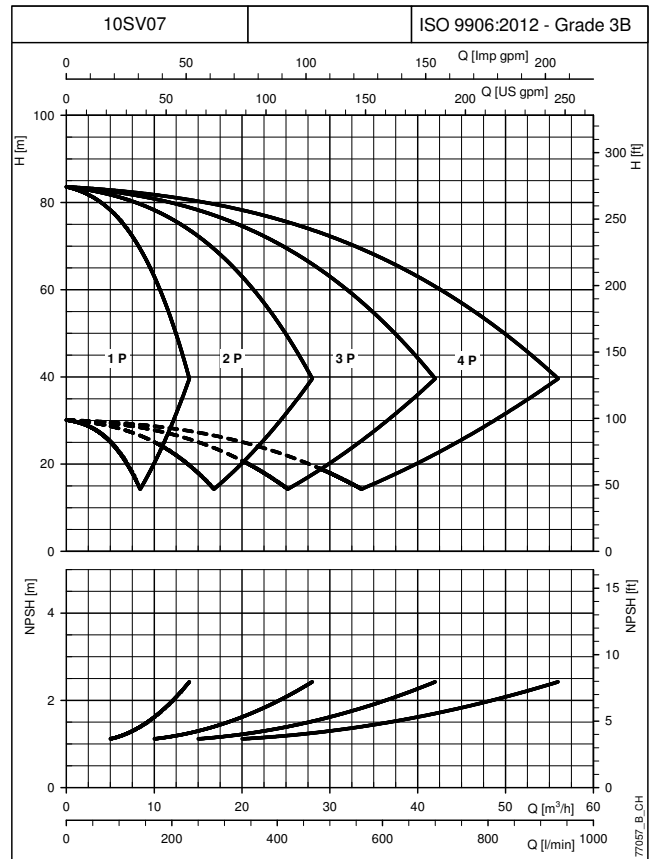
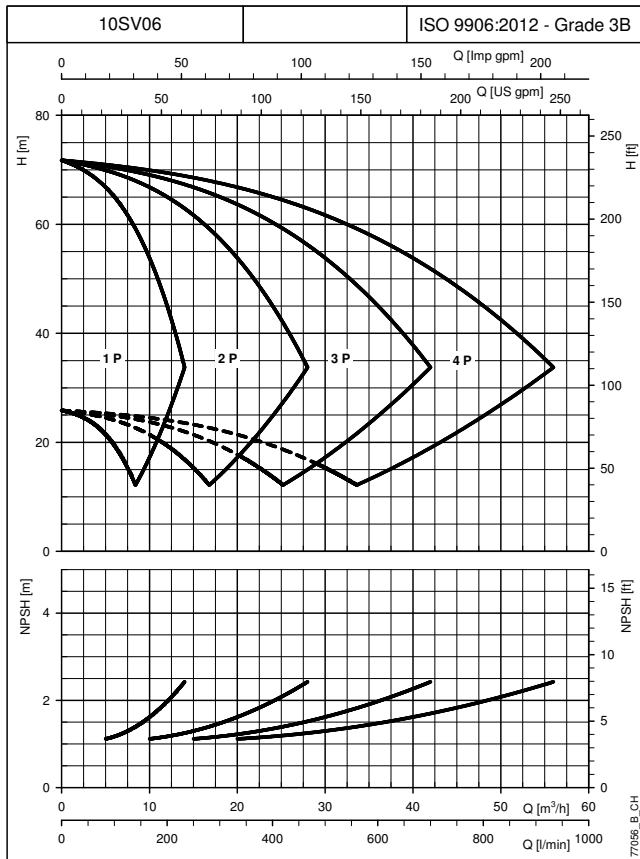
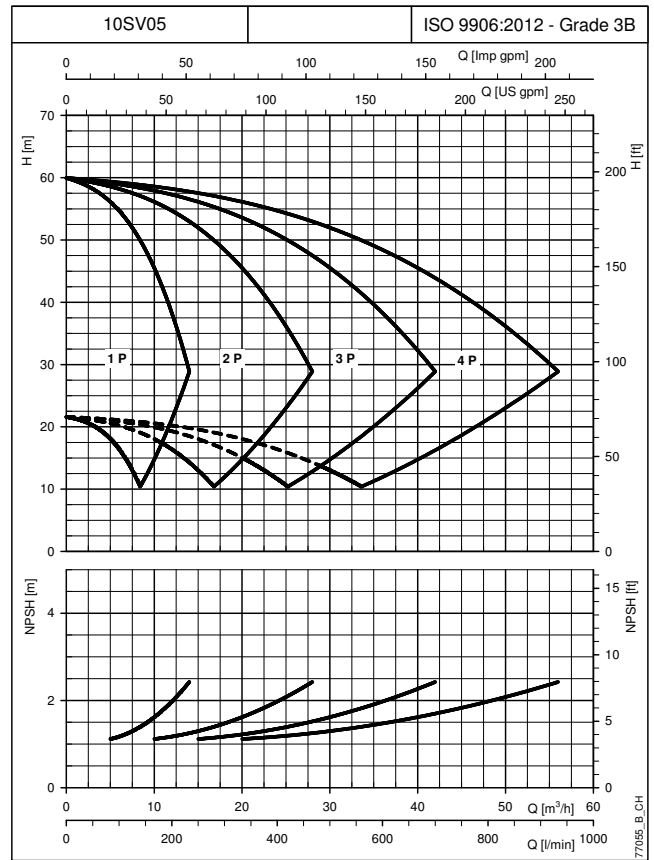
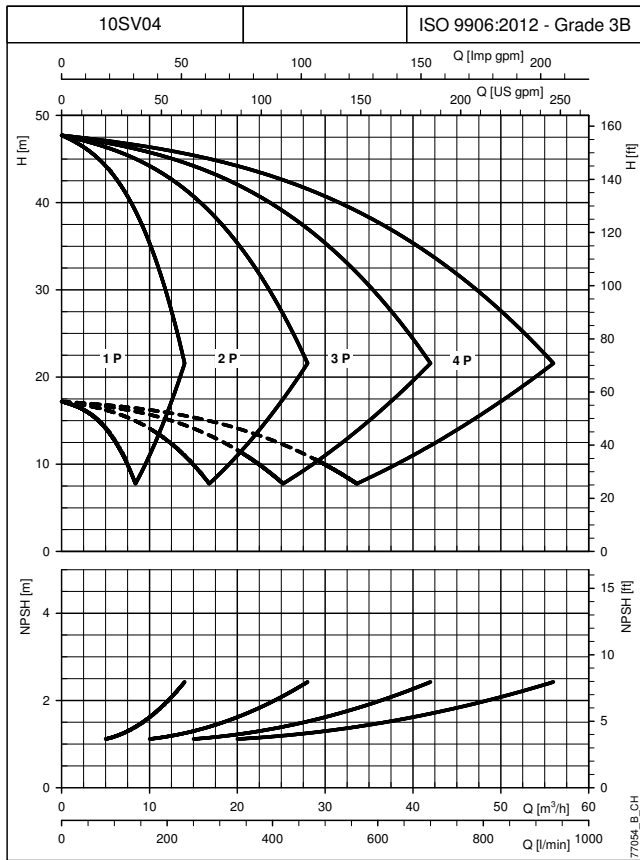

CURVES

The performance curves do not take into account flow resistance in the valves and piping. The curves show the performance with one, two, three and four pumps running. These performances are valid for liquids with density  $\rho = 1.0 \text{ Kg/dm}^3$  and kinematic viscosity  $\nu = 1 \text{ mm}^2/\text{sec}$ . The declared NPSH values are laboratory values; for practical use we recommend increasing these values by 0,5 m.

## GHV.../SV BOOSTER SETS SERIES OPERATING CHARACTERISTICS AT 30..50 Hz

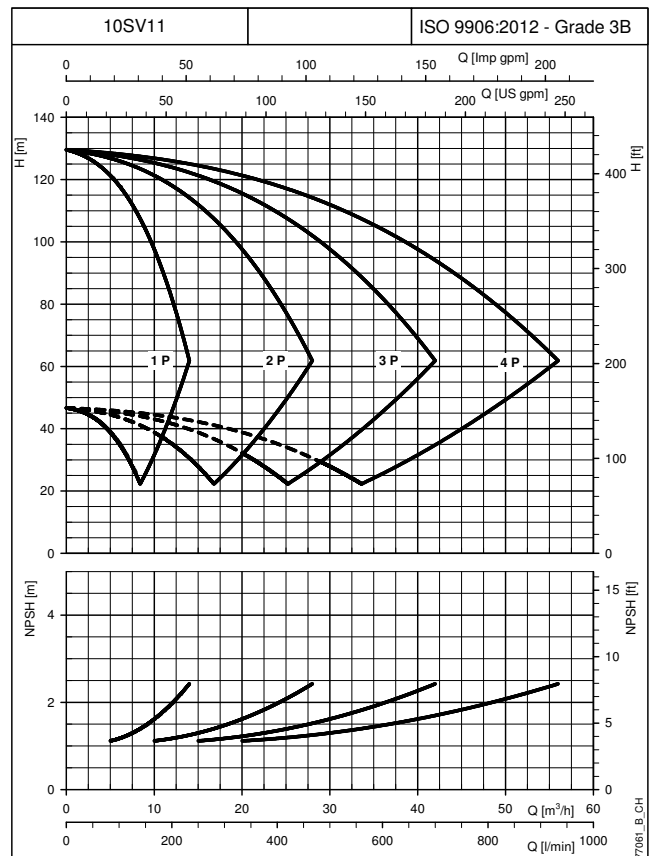
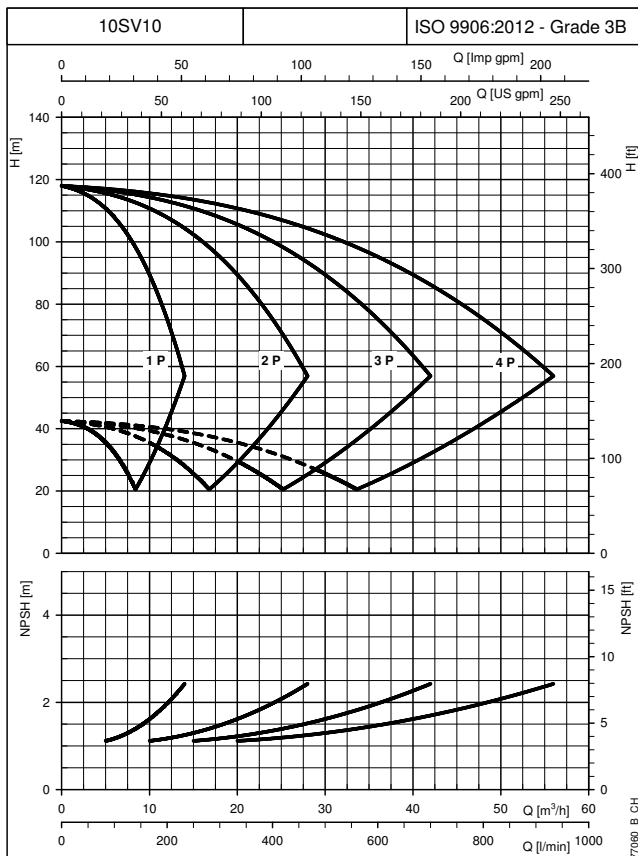
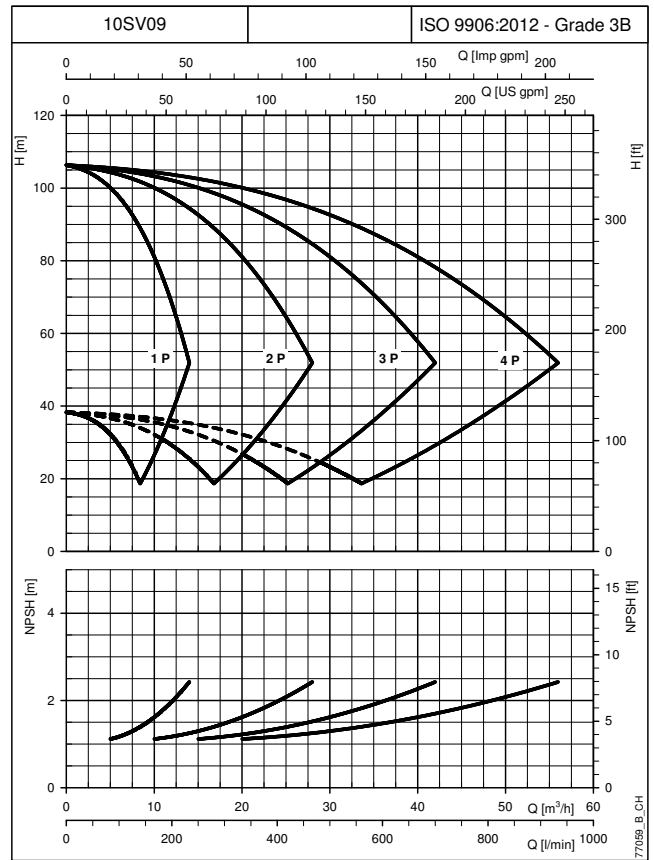
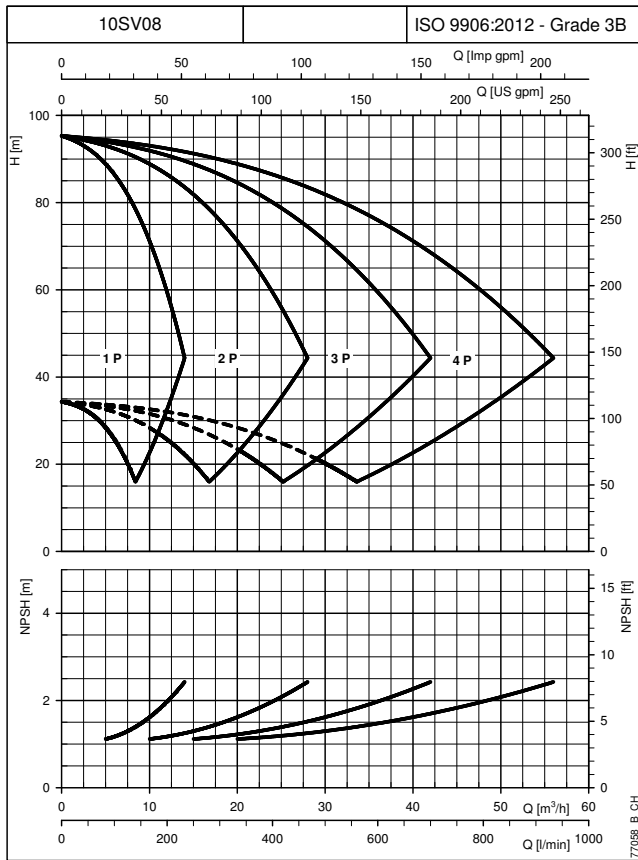

**CURVES**

The performance curves do not take into account flow resistance in the valves and piping. The curves show the performance with one, two, three and four pumps running. These performances are valid for liquids with density  $\rho = 1.0 \text{ Kg/dm}^3$  and kinematic viscosity  $\nu = 1 \text{ mm}^2/\text{sec}$ . The declared NPSH values are laboratory values; for practical use we recommend increasing these values by 0,5 m.

## GHV.../SV BOOSTER SETS SERIES OPERATING CHARACTERISTICS AT 30..50 Hz

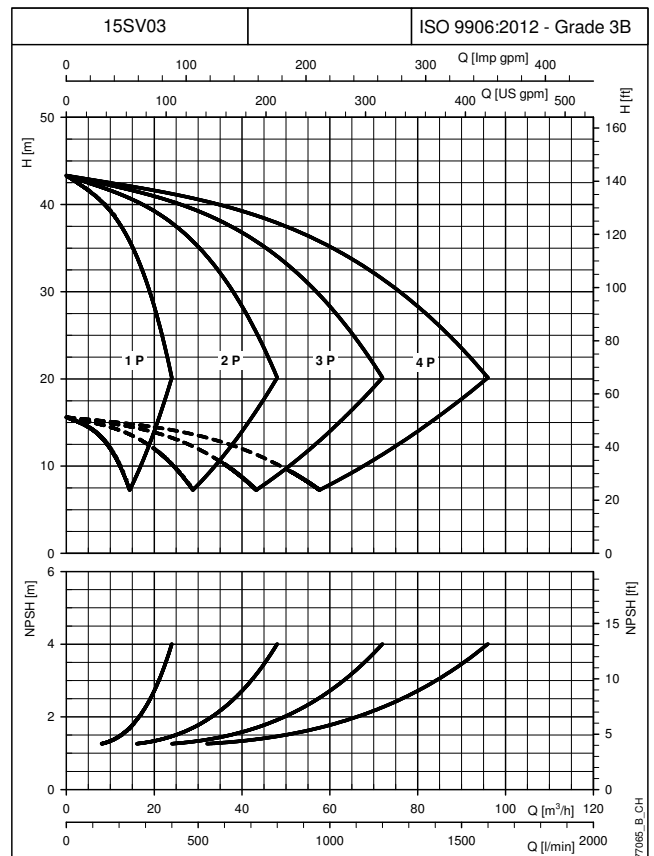
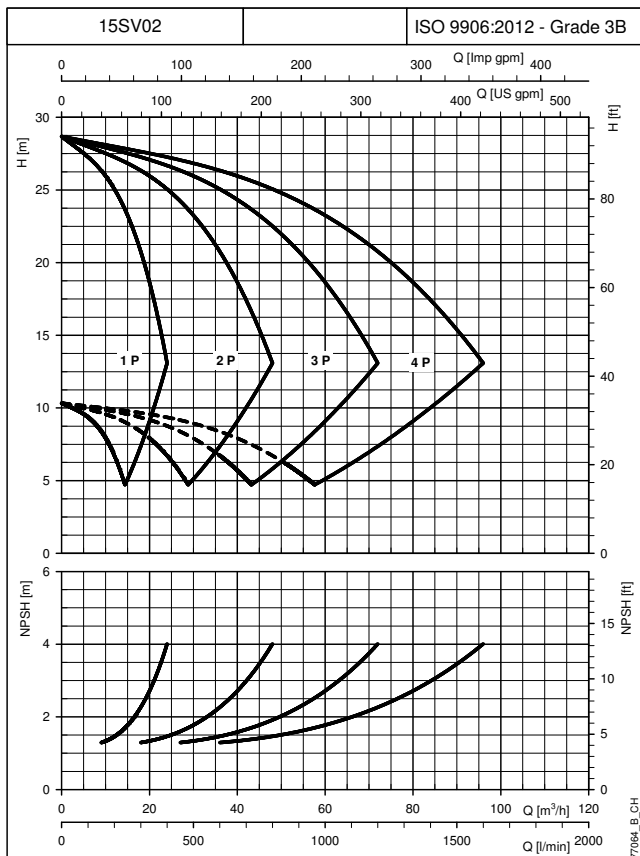
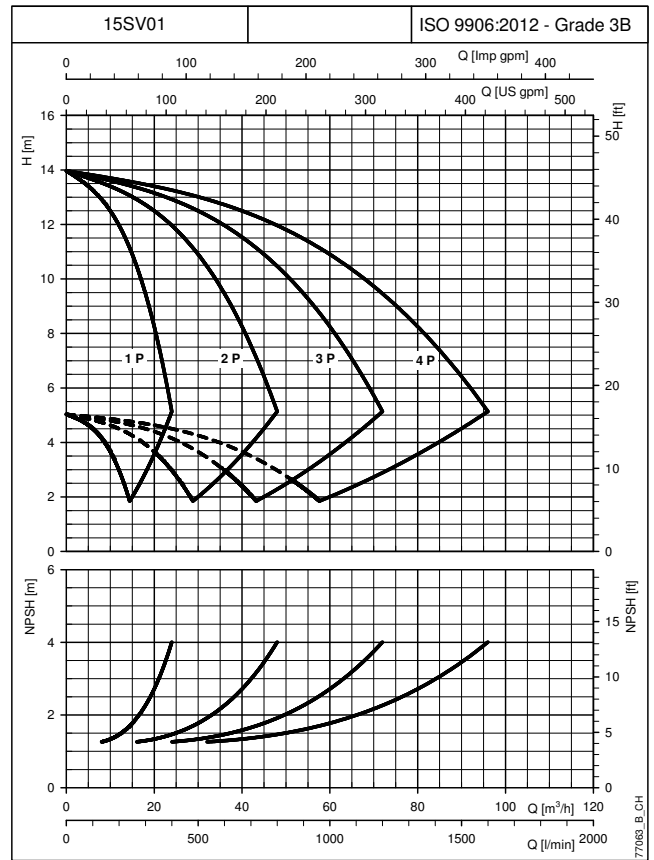
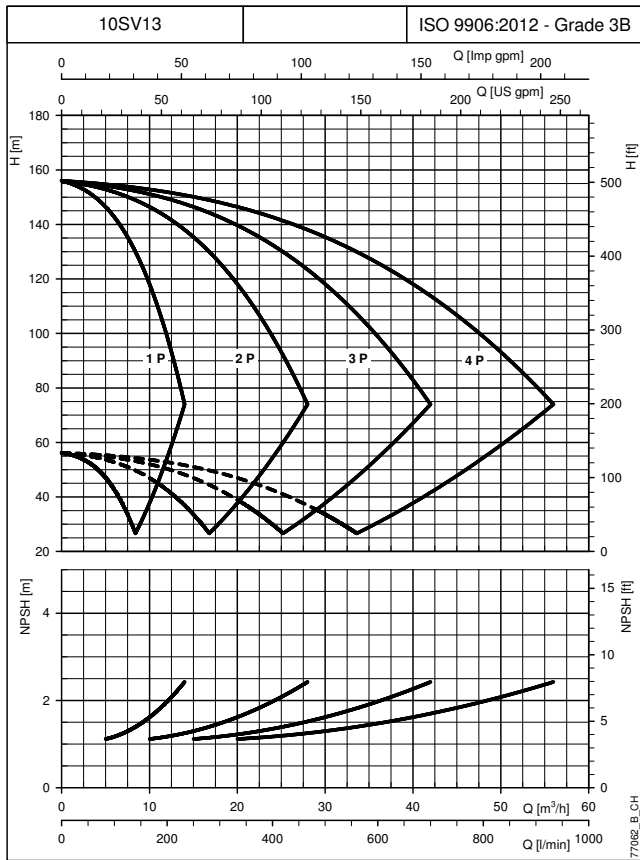

CURVES

The performance curves do not take into account flow resistance in the valves and piping. The curves show the performance with one, two, three and four pumps running. These performances are valid for liquids with density  $\rho = 1.0 \text{ Kg/dm}^3$  and kinematic viscosity  $\nu = 1 \text{ mm}^2/\text{sec}$ . The declared NPSH values are laboratory values; for practical use we recommend increasing these values by 0,5 m.



**GHV.../SV BOOSTER SETS SERIES  
OPERATING CHARACTERISTICS AT 30..50 Hz**

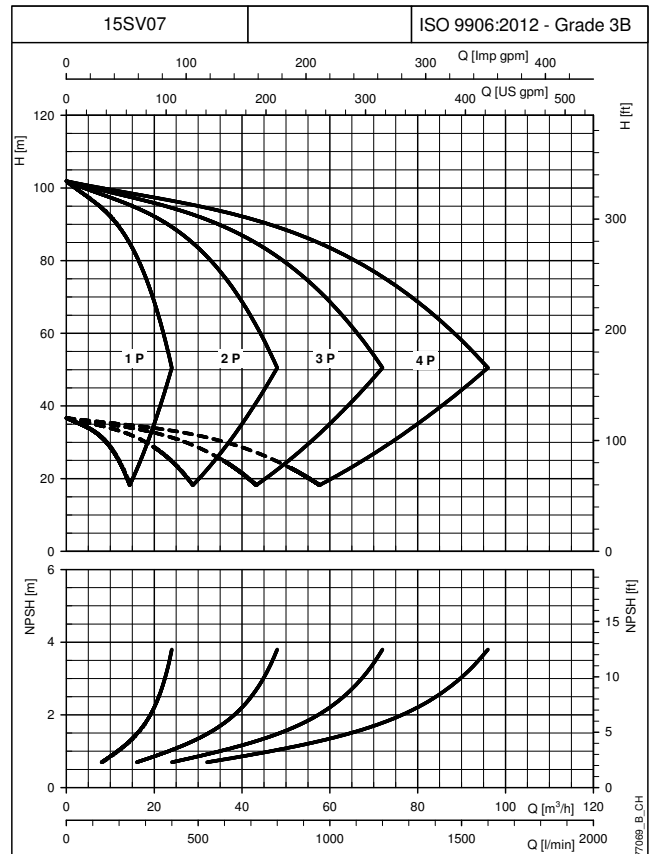
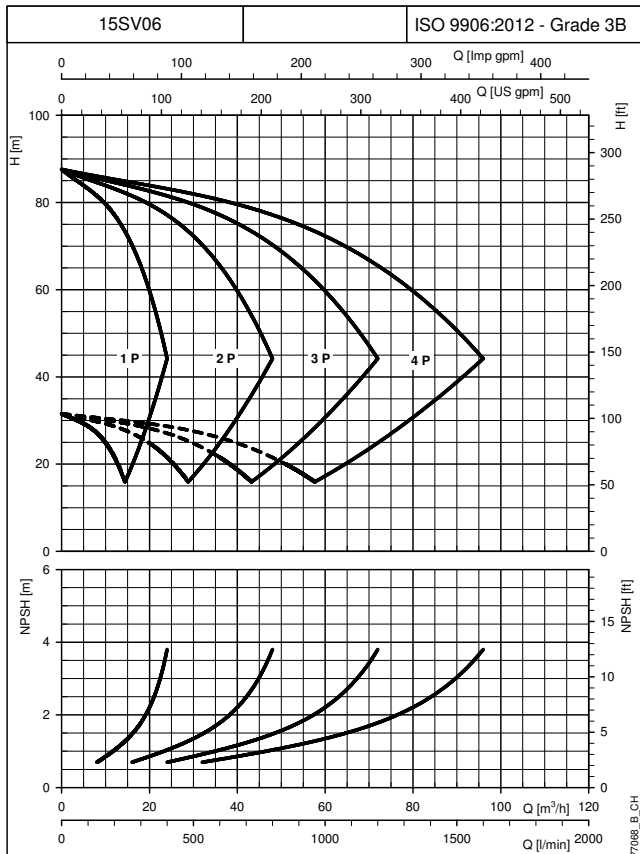
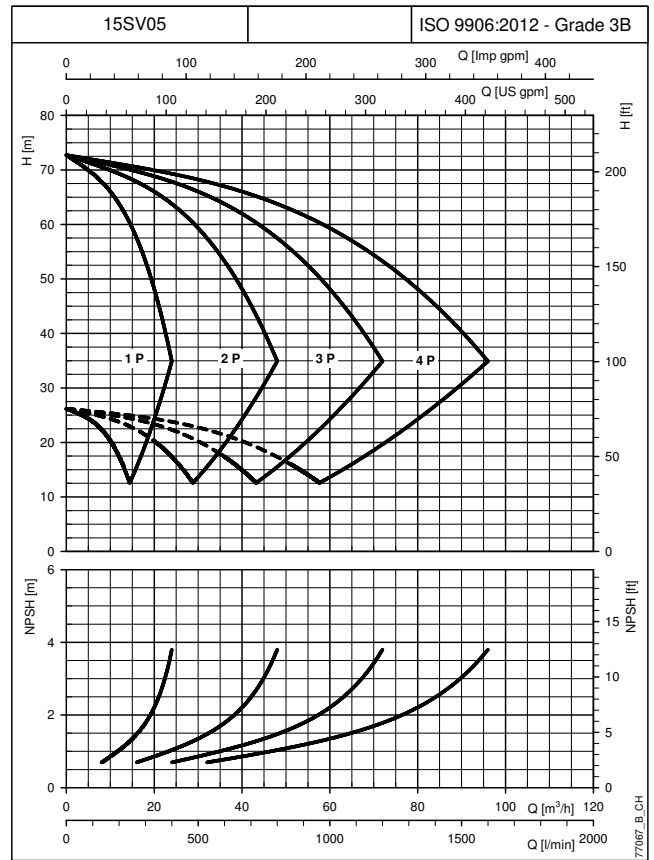
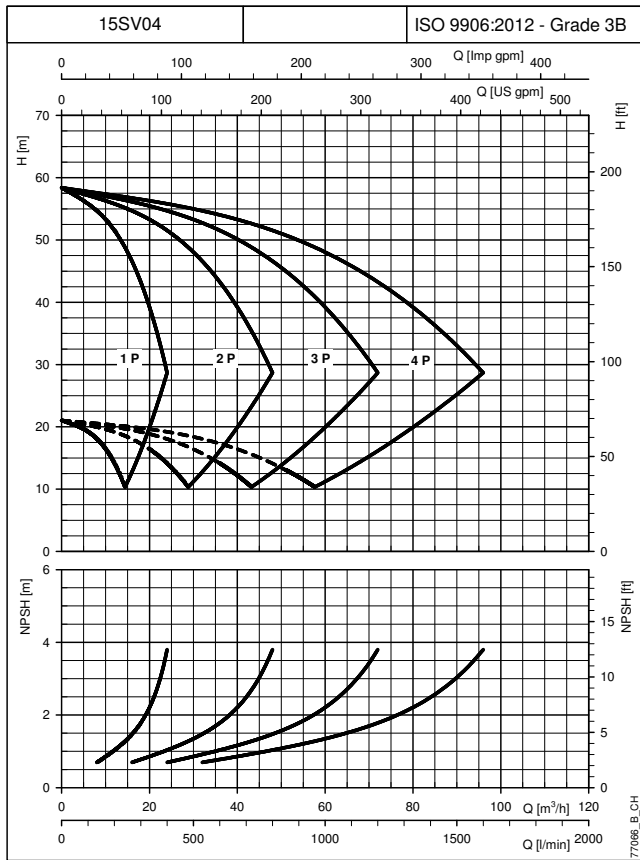

The performance curves do not take into account flow resistance in the valves and piping. The curves show the performance with one, two, three and four pumps running. These performances are valid for liquids with density  $\rho = 1.0 \text{ Kg/dm}^3$  and kinematic viscosity  $\nu = 1 \text{ mm}^2/\text{sec}$ . The declared NPSH values are laboratory values; for practical use we recommend increasing these values by 0,5 m.

**CURVES**

## GHV.../SV BOOSTER SETS SERIES OPERATING CHARACTERISTICS AT 30..50 Hz

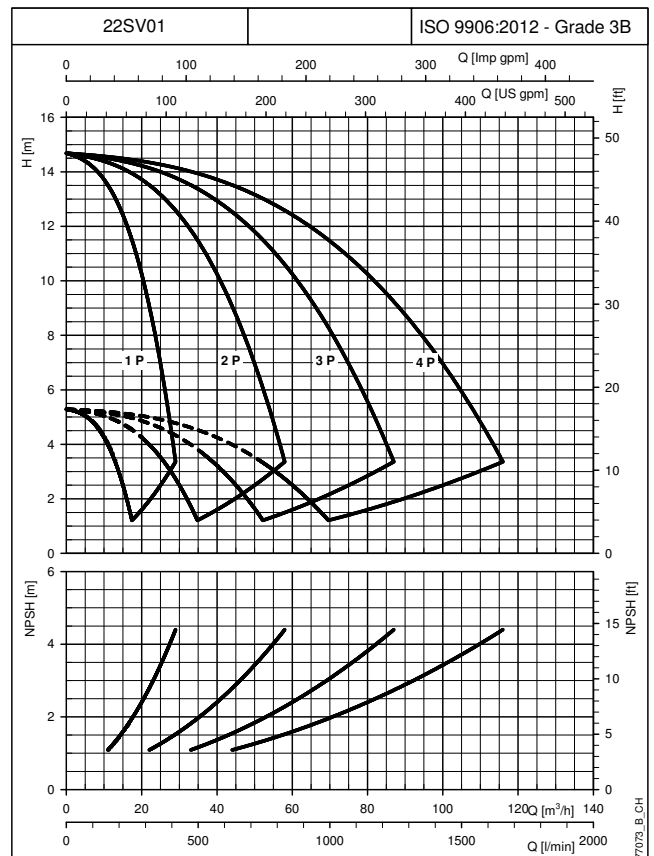
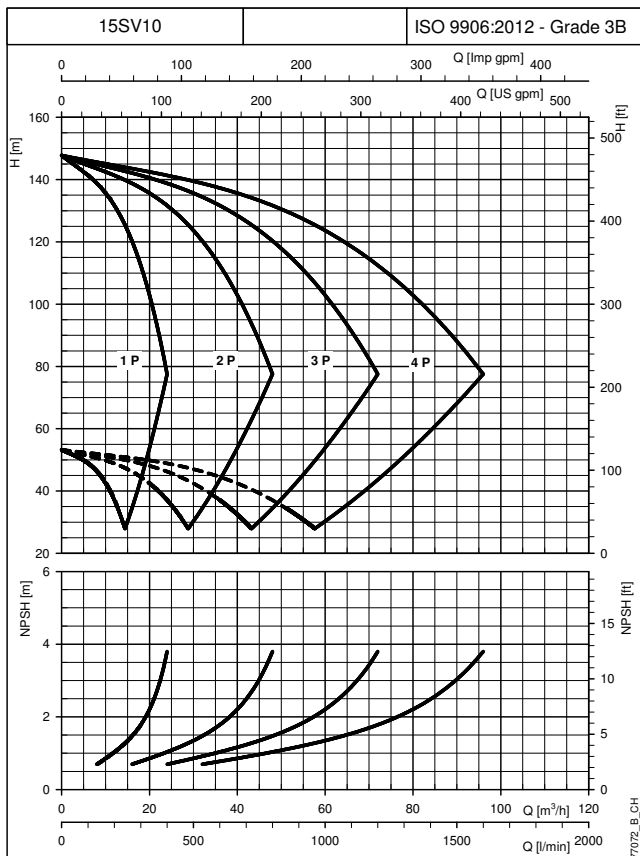
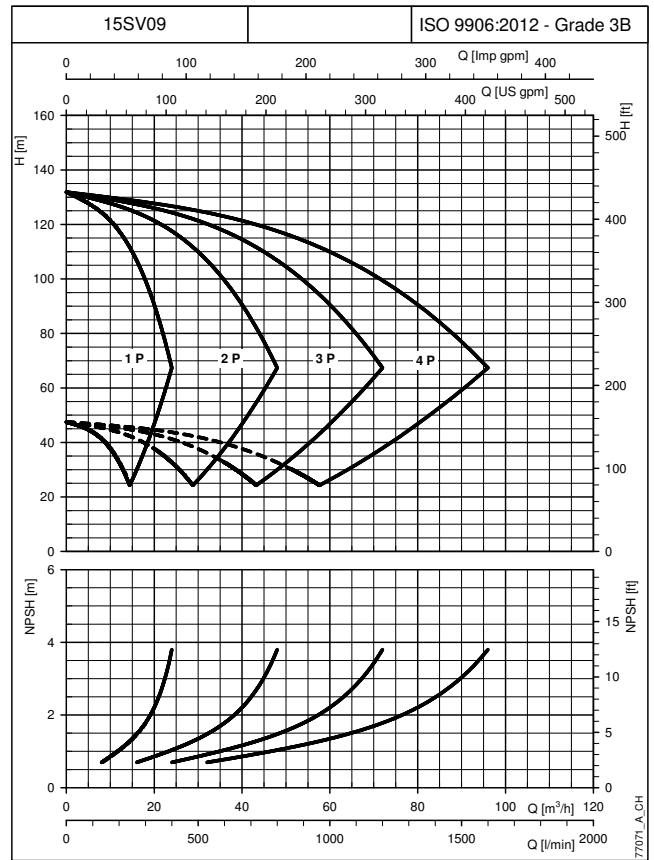
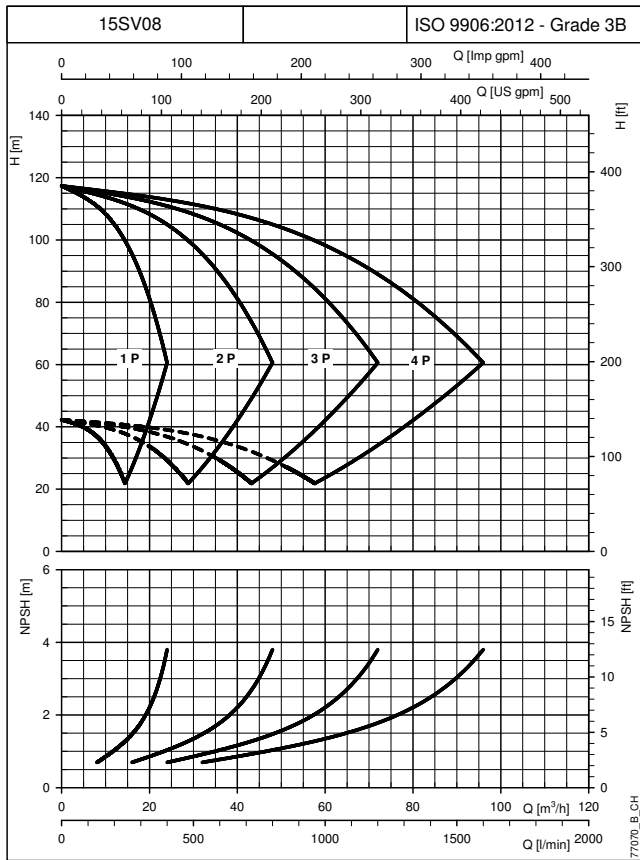

**CURVES**

The performance curves do not take into account flow resistance in the valves and piping. The curves show the performance with one, two, three and four pumps running. These performances are valid for liquids with density  $\rho = 1.0 \text{ Kg/dm}^3$  and kinematic viscosity  $\nu = 1 \text{ mm}^2/\text{sec}$ . The declared NPSH values are laboratory values; for practical use we recommend increasing these values by 0,5 m.

**GHV.../SV BOOSTER SETS SERIES  
OPERATING CHARACTERISTICS AT 30..50 Hz**

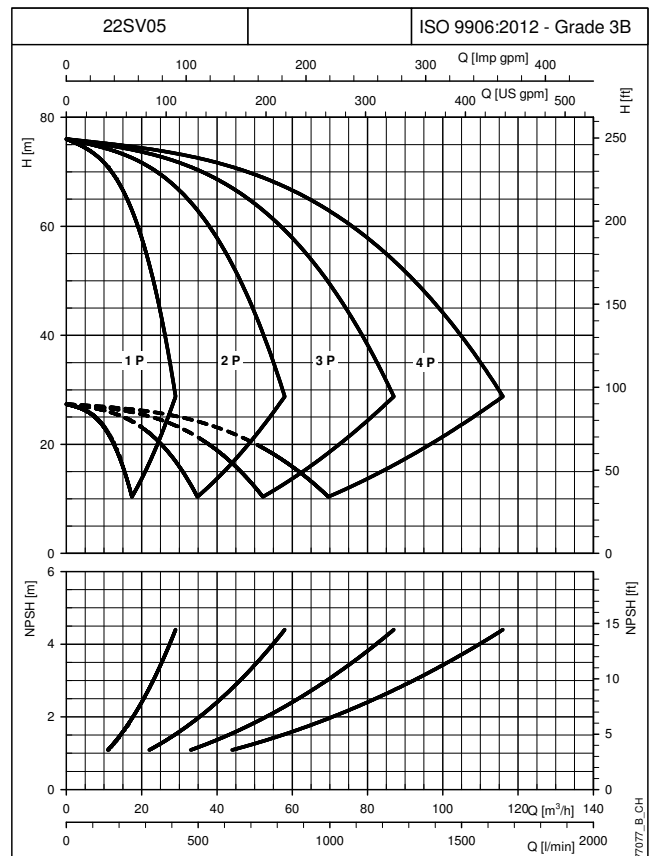
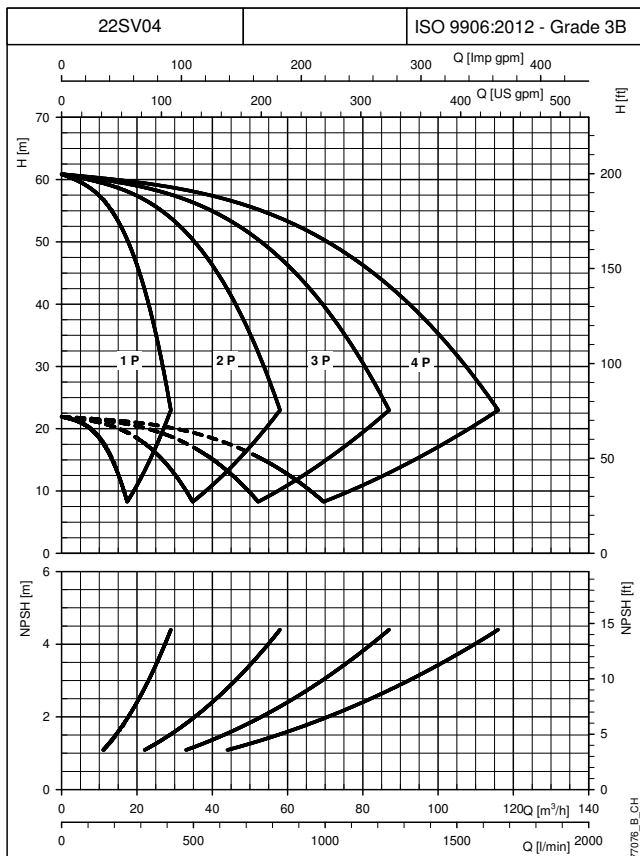
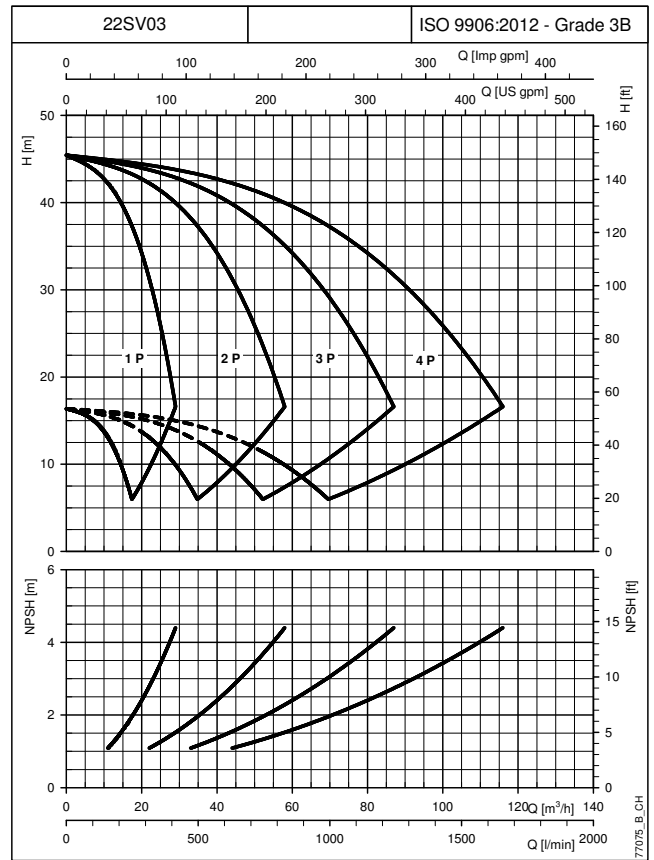
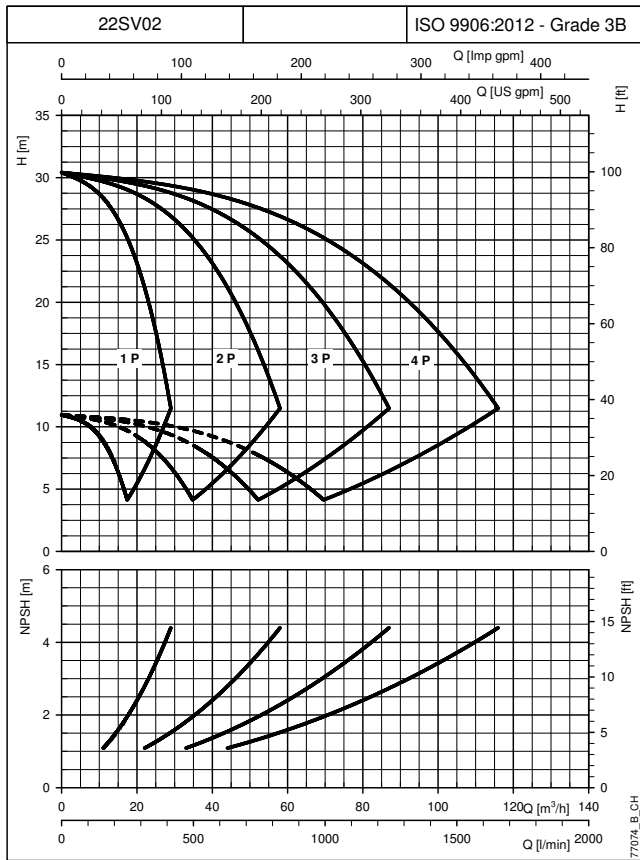

**CURVES**

The performance curves do not take into account flow resistance in the valves and piping. The curves show the performance with one, two, three and four pumps running. These performances are valid for liquids with density  $\rho = 1.0 \text{ Kg/dm}^3$  and kinematic viscosity  $\nu = 1 \text{ mm}^2/\text{sec}$ . The declared NPSH values are laboratory values; for practical use we recommend increasing these values by 0,5 m.

**GHV.../SV BOOSTER SETS SERIES  
OPERATING CHARACTERISTICS AT 30..50 Hz**

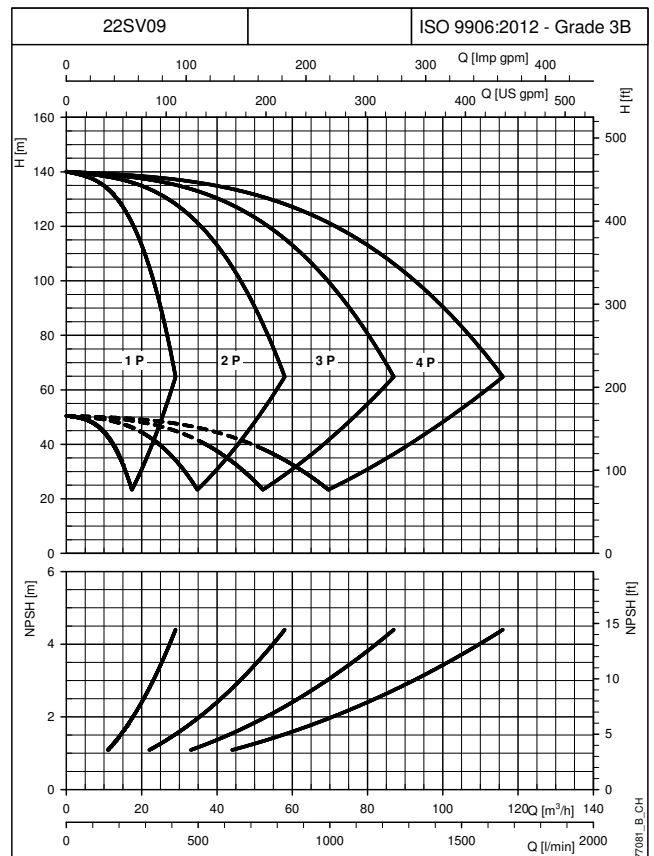
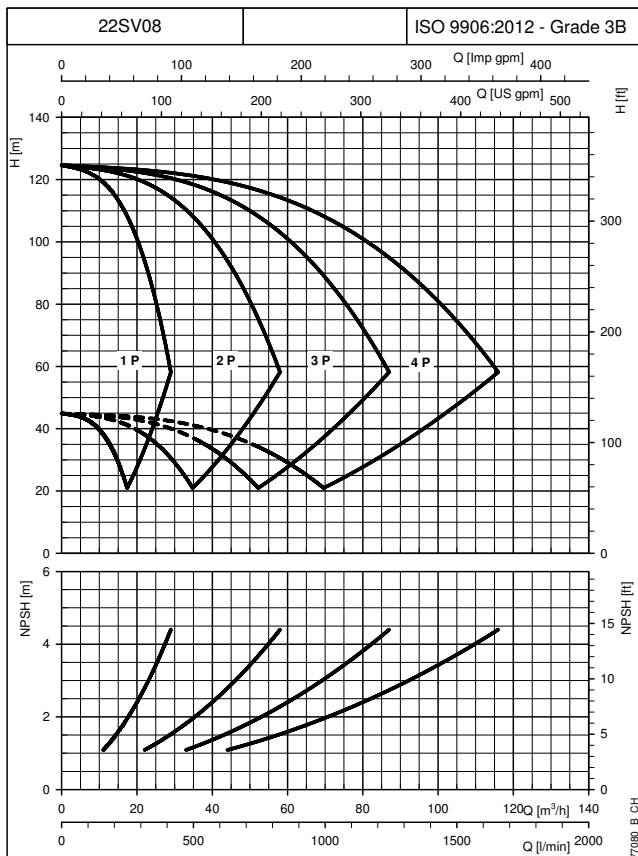
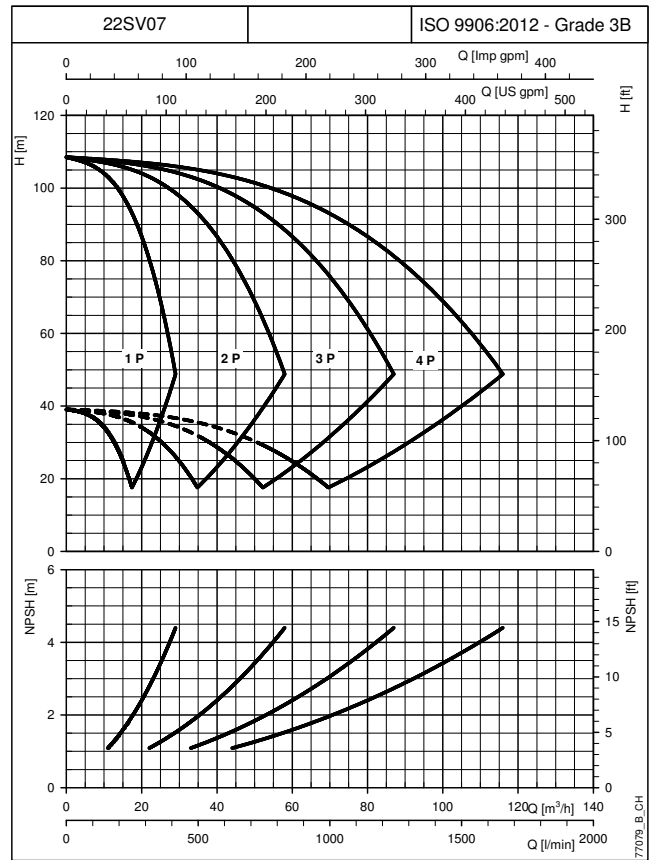
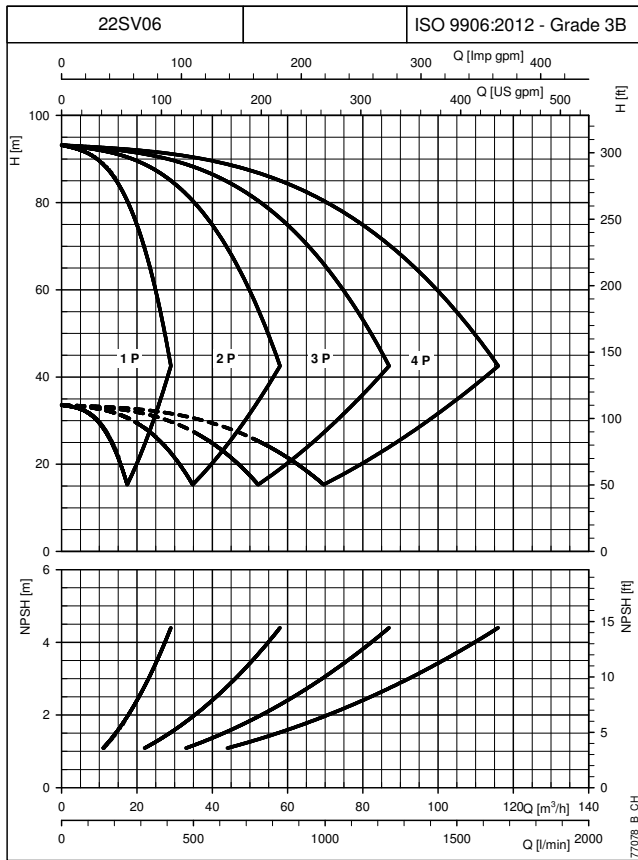

**CURVES**

The performance curves do not take into account flow resistance in the valves and piping. The curves show the performance with one, two, three and four pumps running. These performances are valid for liquids with density  $\rho = 1.0 \text{ Kg/dm}^3$  and kinematic viscosity  $\nu = 1 \text{ mm}^2/\text{sec}$ . The declared NPSH values are laboratory values; for practical use we recommend increasing these values by 0,5 m.

# GHV.../SV BOOSTER SETS SERIES OPERATING CHARACTERISTICS AT 30..50 Hz

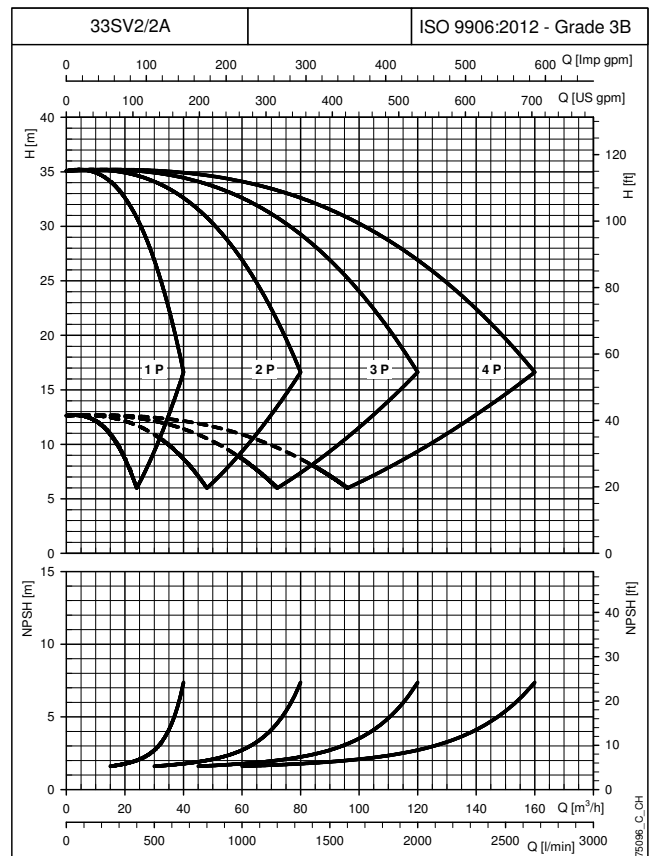
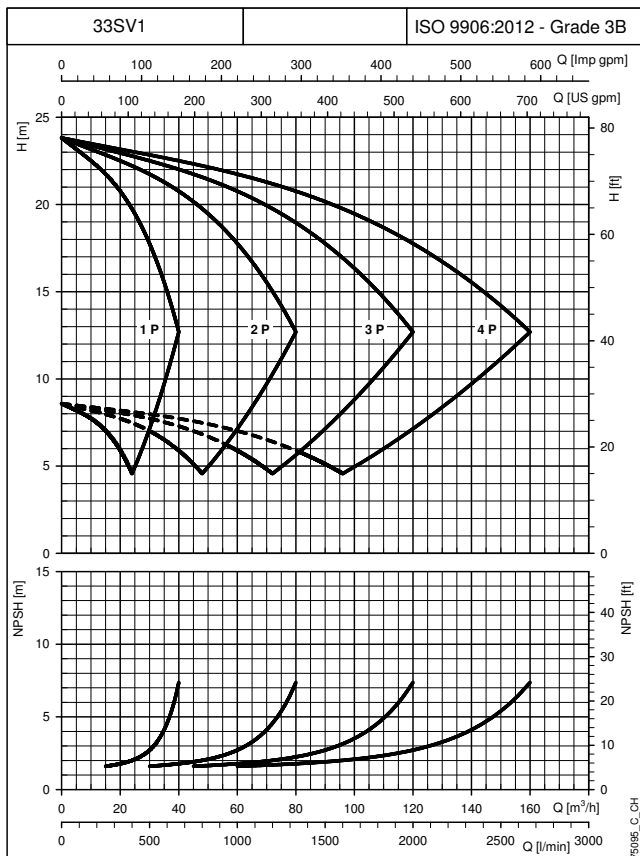
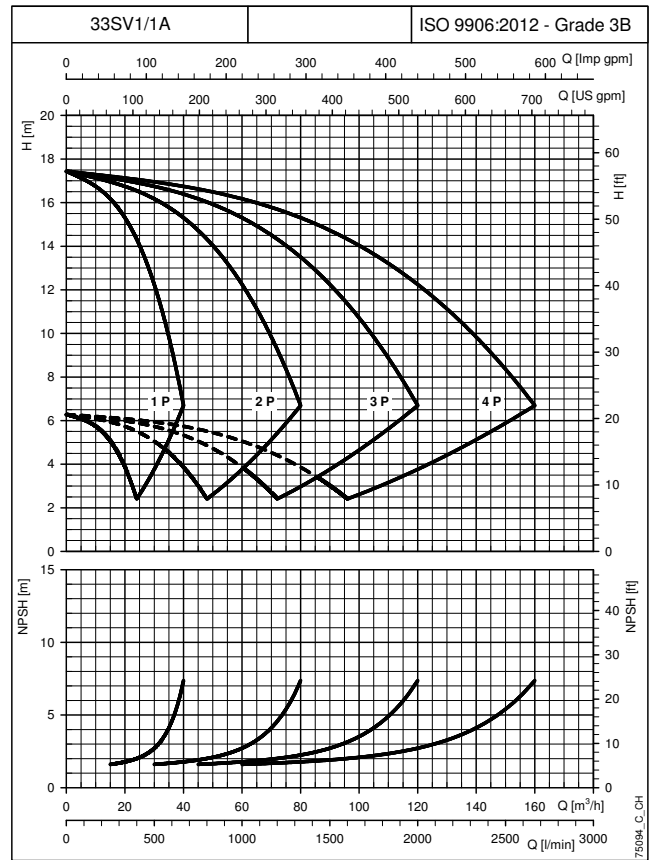
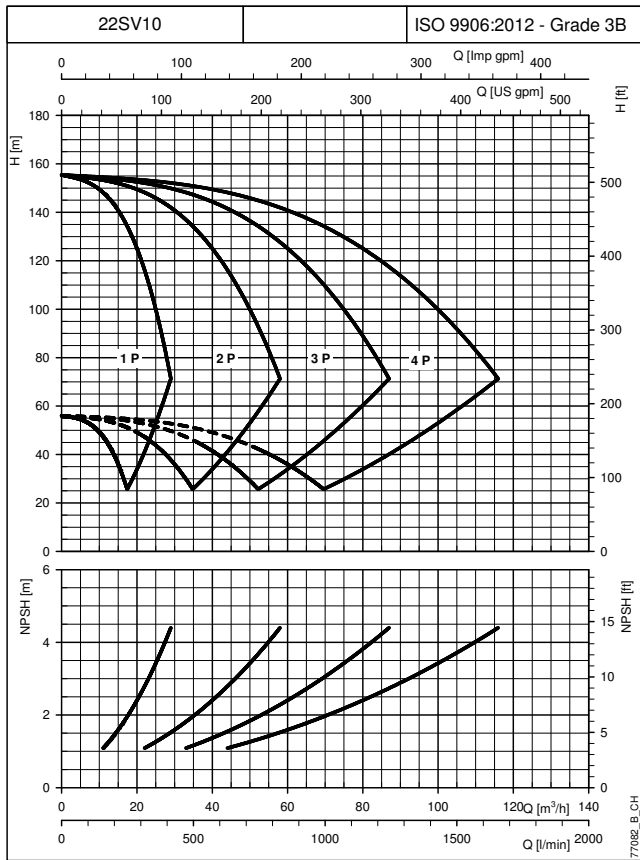

The performance curves do not take into account flow resistance in the valves and piping. The curves show the performance with one, two, three and four pumps running. These performances are valid for liquids with density  $\rho = 1.0 \text{ Kg/dm}^3$  and kinematic viscosity  $\nu = 1 \text{ mm}^2/\text{sec}$ . The declared NPSH values are laboratory values; for practical use we recommend increasing these values by 0,5 m.

**CURVES**

## GHV.../SV BOOSTER SETS SERIES OPERATING CHARACTERISTICS AT 30..50 Hz

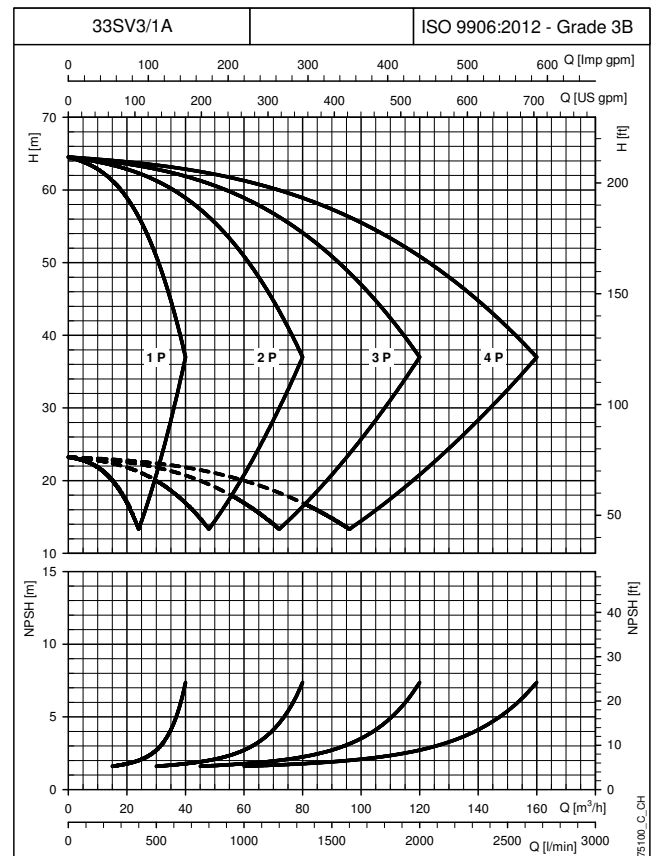
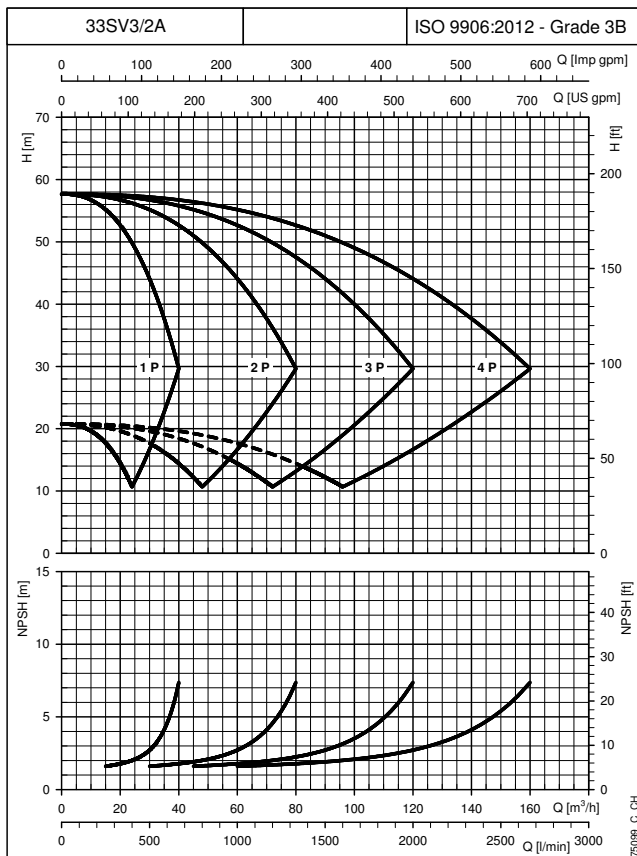
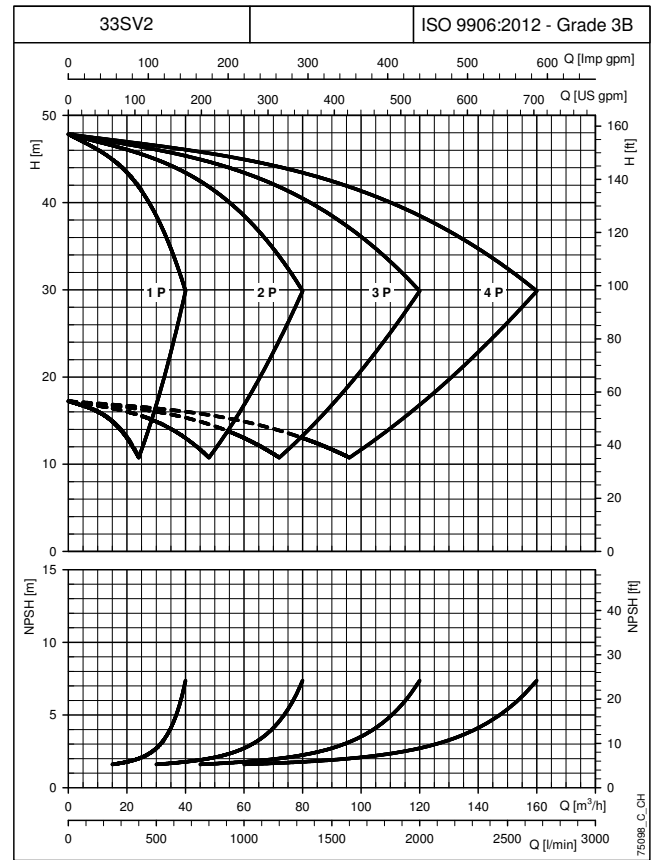
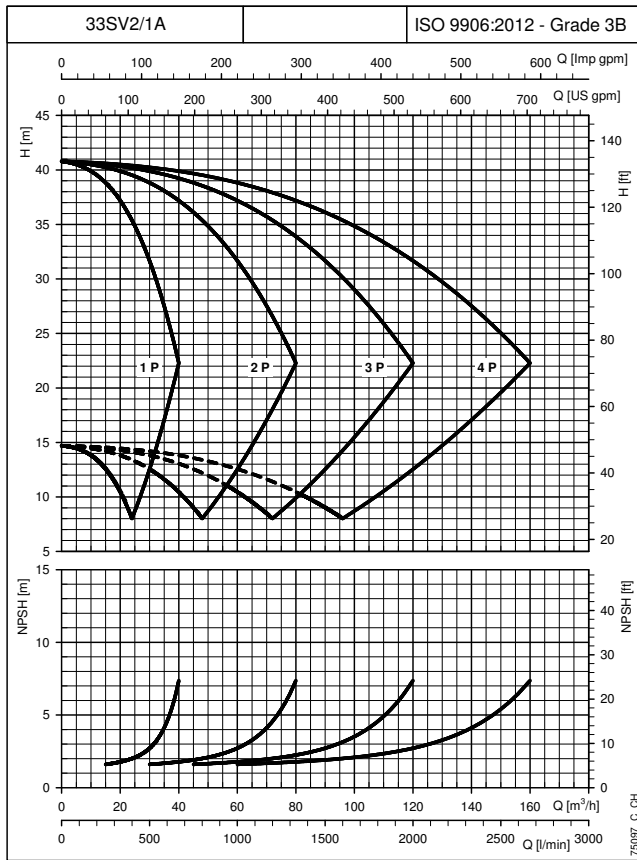

CURVES

The performance curves do not take into account flow resistance in the valves and piping. The curves show the performance with one, two, three and four pumps running. These performances are valid for liquids with density  $\rho = 1.0 \text{ Kg/dm}^3$  and kinematic viscosity  $\nu = 1 \text{ mm}^2/\text{sec}$ . The declared NPSH values are laboratory values; for practical use we recommend increasing these values by 0,5 m.

## GHV.../SV BOOSTER SETS SERIES OPERATING CHARACTERISTICS AT 30..50 Hz

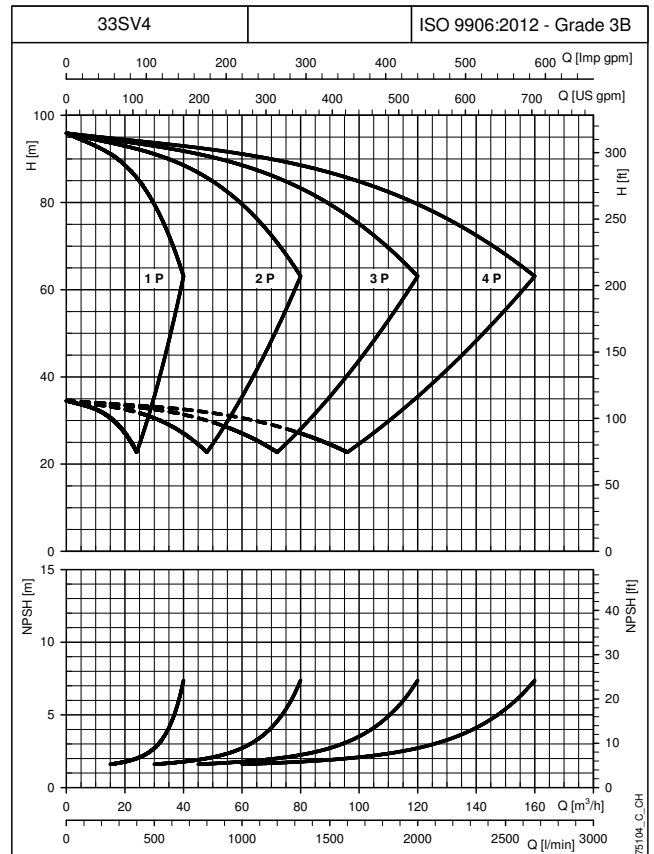
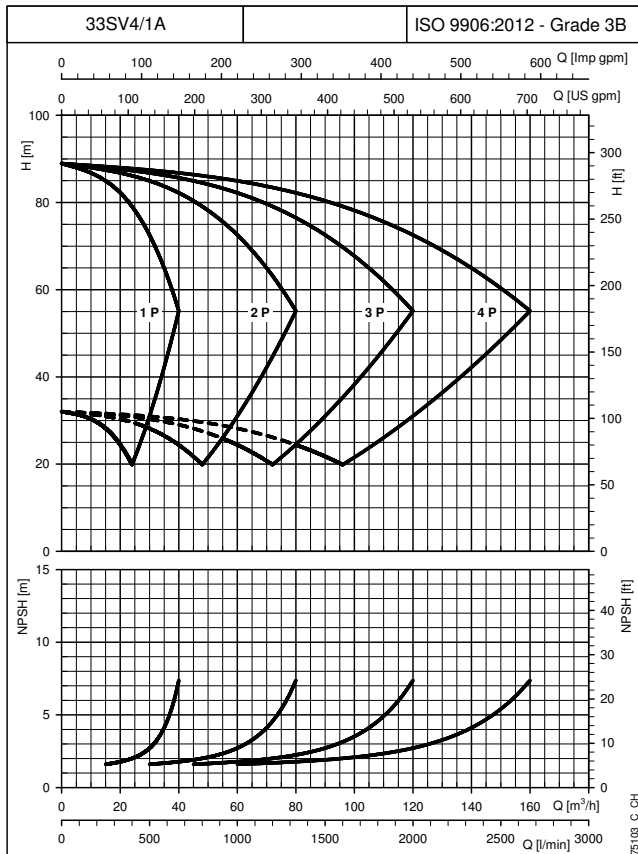
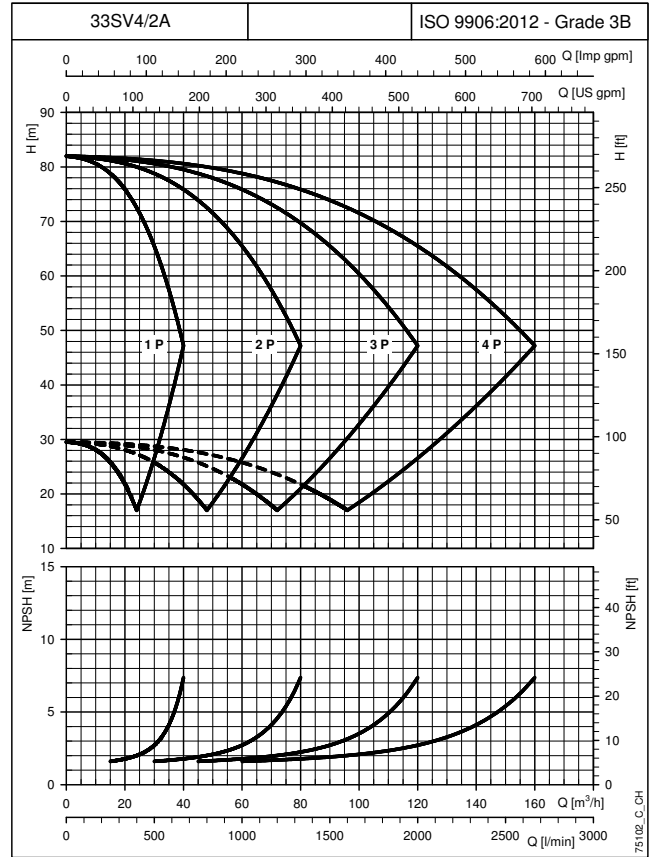
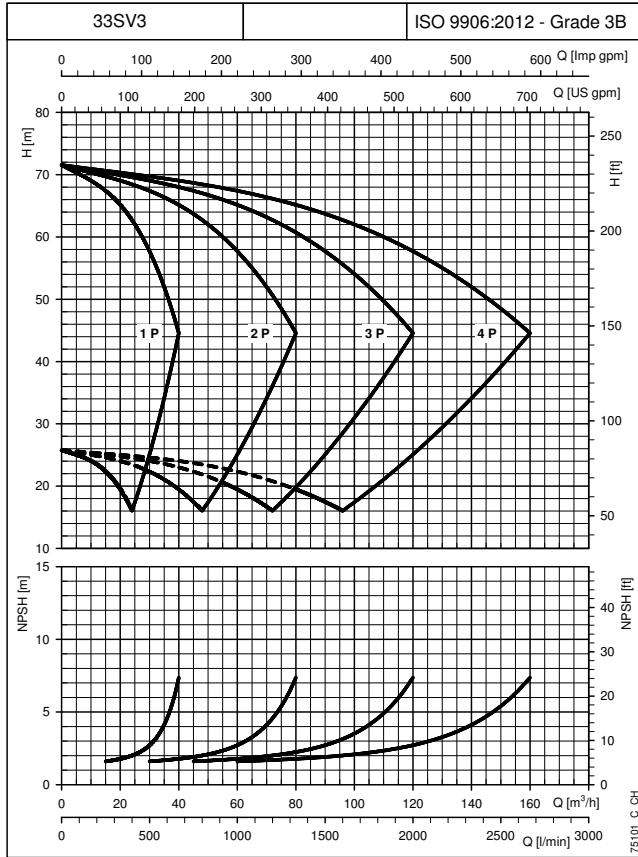

**CURVES**

The performance curves do not take into account flow resistance in the valves and piping. The curves show the performance with one, two, three and four pumps running. These performances are valid for liquids with density  $\rho = 1.0 \text{ Kg/dm}^3$  and kinematic viscosity  $\nu = 1 \text{ mm}^2/\text{sec}$ . The declared NPSH values are laboratory values; for practical use we recommend increasing these values by 0,5 m.

# GHV.../SV BOOSTER SETS SERIES OPERATING CHARACTERISTICS AT 30..50 Hz

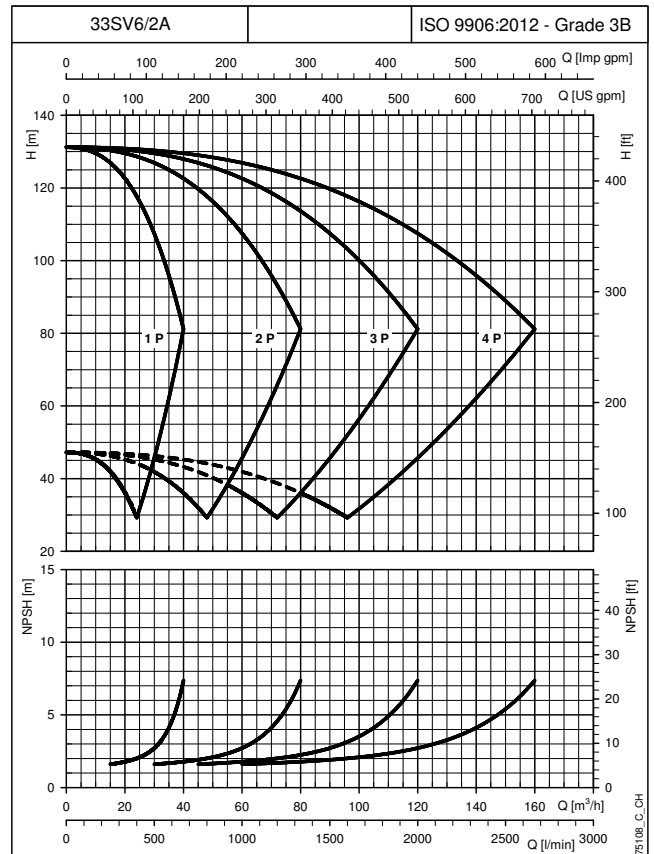
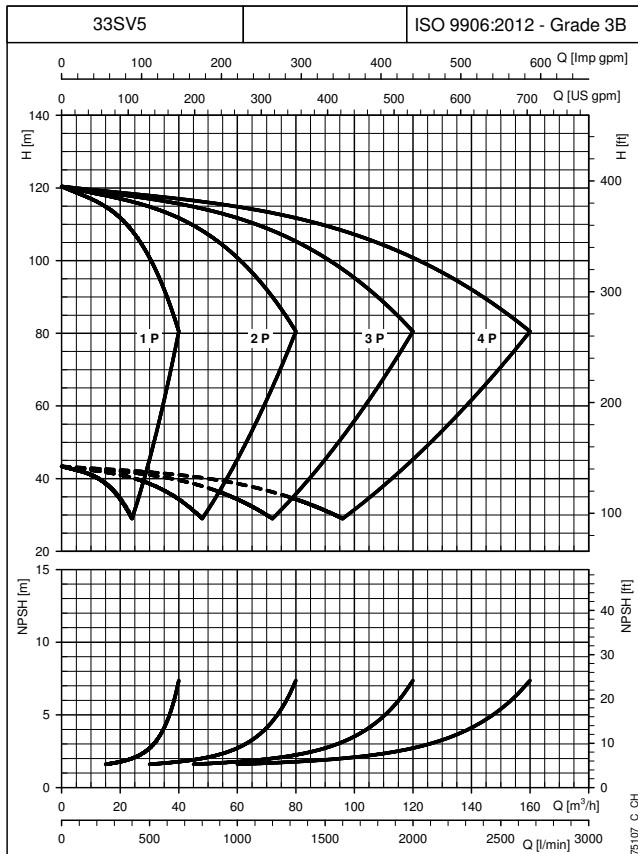
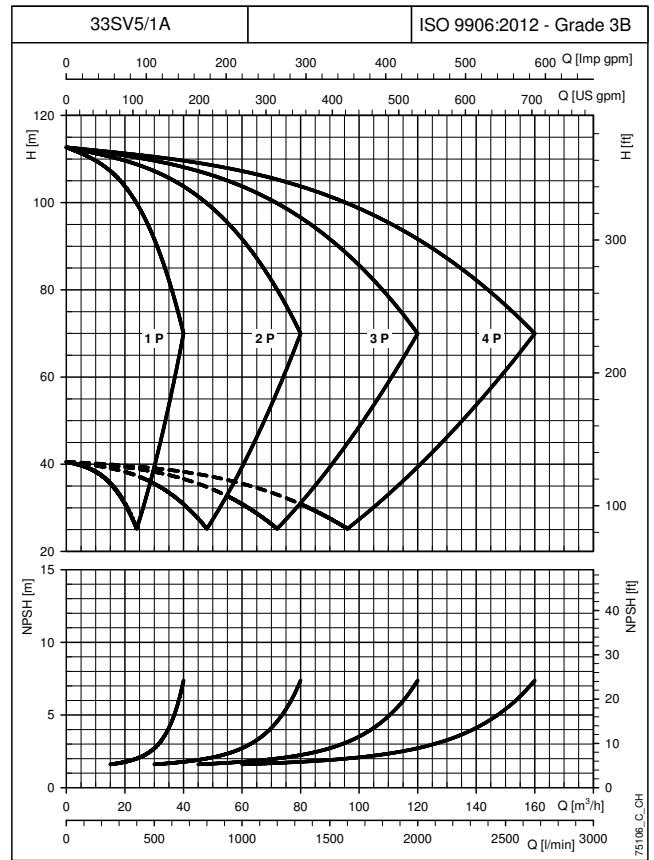
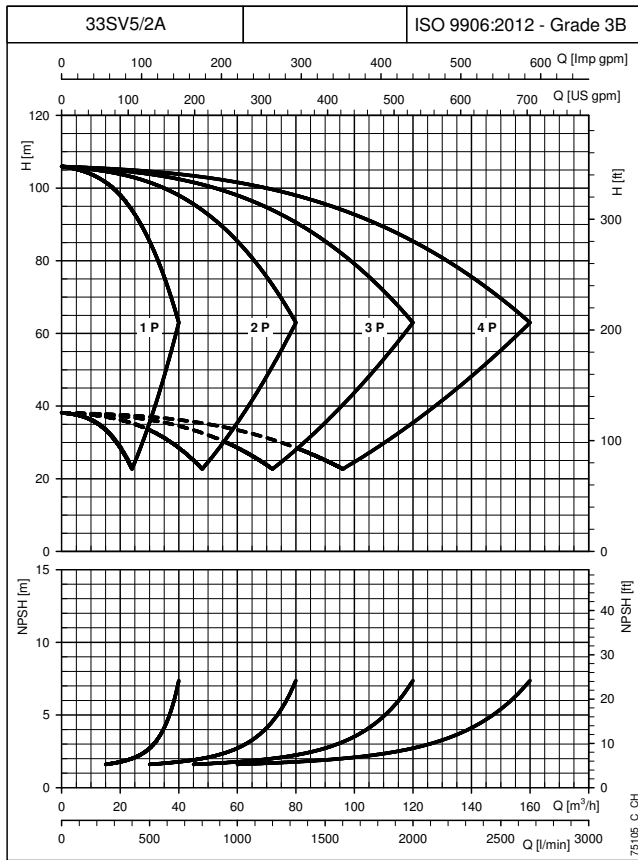

CURVES

The performance curves do not take into account flow resistance in the valves and piping. The curves show the performance with one, two, three and four pumps running. These performances are valid for liquids with density  $\rho = 1.0 \text{ Kg/dm}^3$  and kinematic viscosity  $\nu = 1 \text{ mm}^2/\text{sec}$ . The declared NPSH values are laboratory values; for practical use we recommend increasing these values by 0,5 m.



## GHV.../SV BOOSTER SETS SERIES OPERATING CHARACTERISTICS AT 30..50 Hz

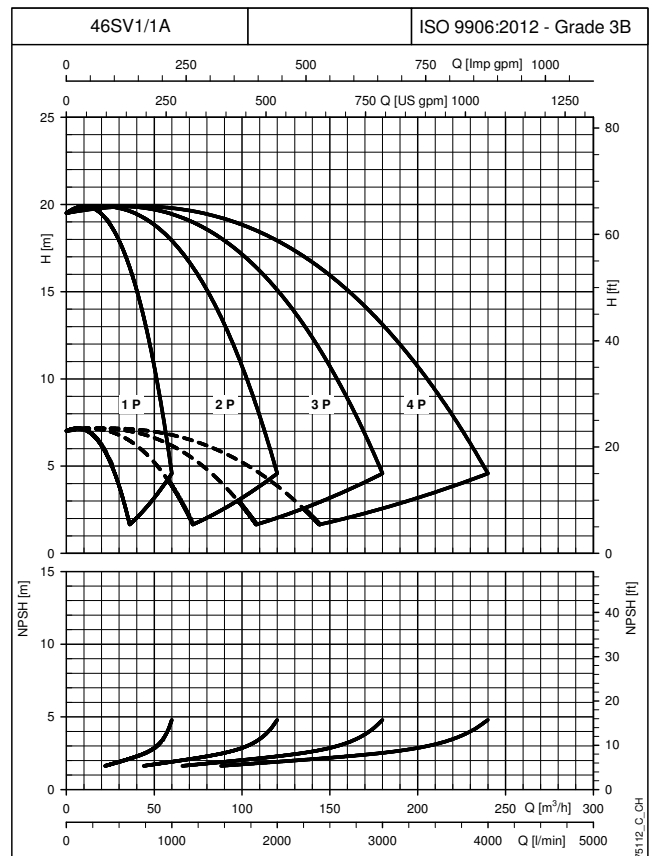
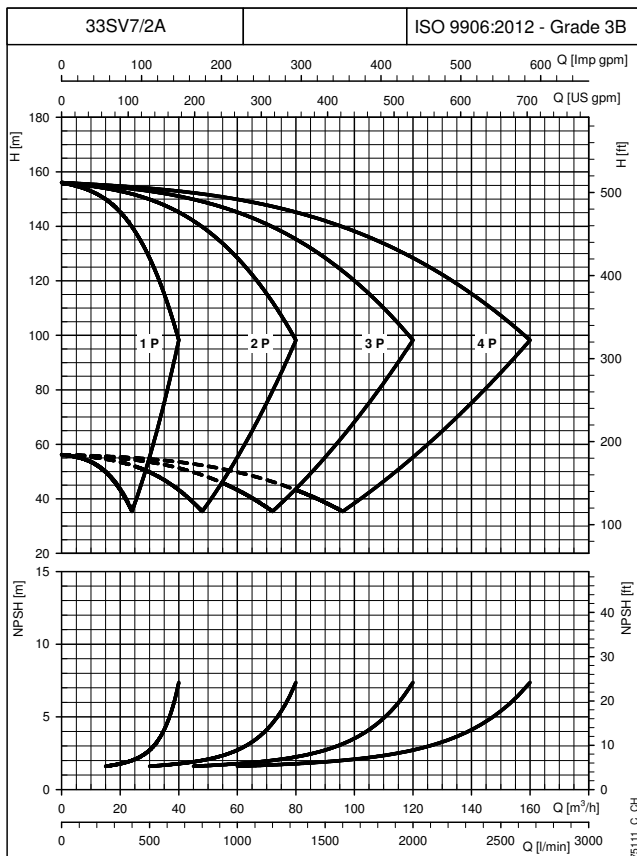
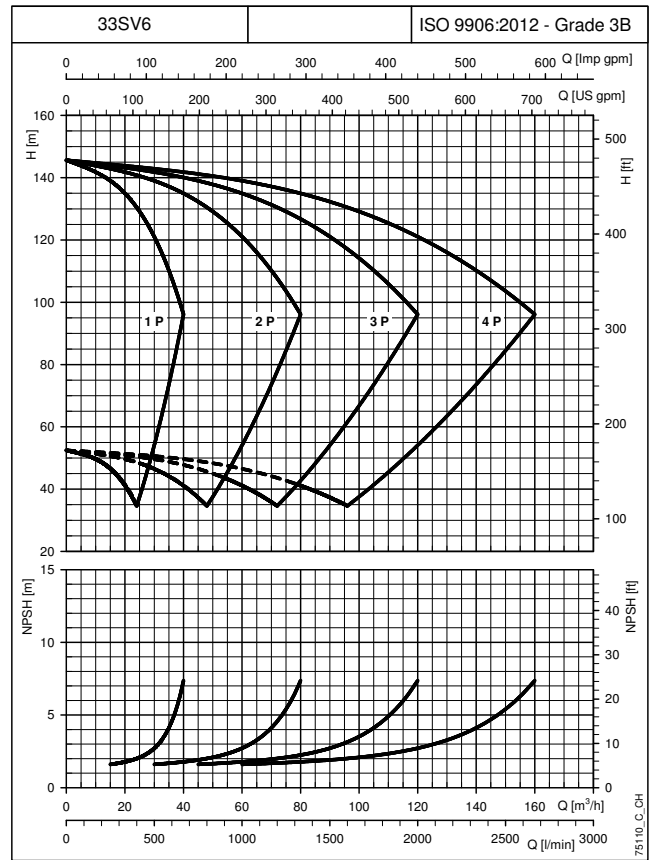
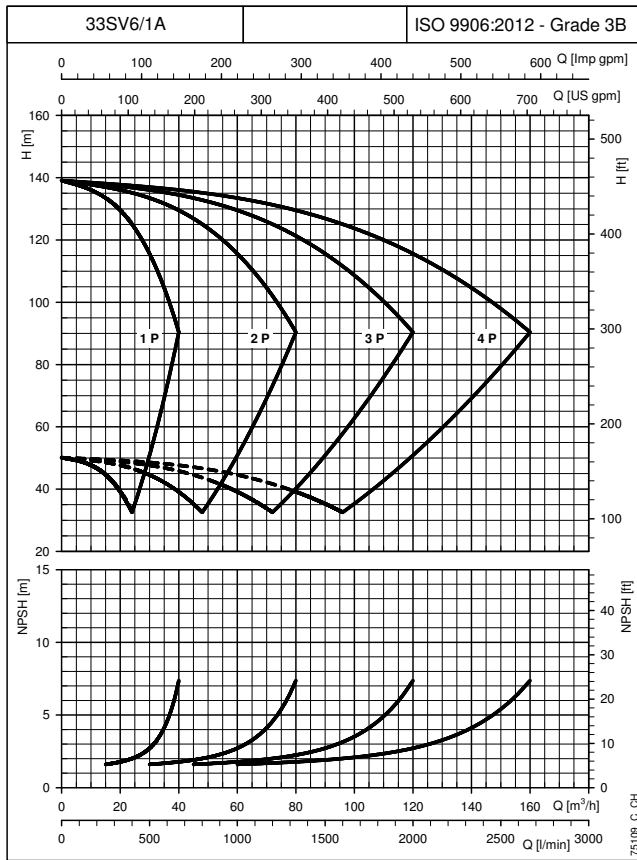

**CURVES**

The performance curves do not take into account flow resistance in the valves and piping. The curves show the performance with one, two, three and four pumps running. These performances are valid for liquids with density  $\rho = 1.0 \text{ Kg/dm}^3$  and kinematic viscosity  $\nu = 1 \text{ mm}^2/\text{sec}$ . The declared NPSH values are laboratory values; for practical use we recommend increasing these values by 0,5 m.

## GHV.../SV BOOSTER SETS SERIES OPERATING CHARACTERISTICS AT 30..50 Hz

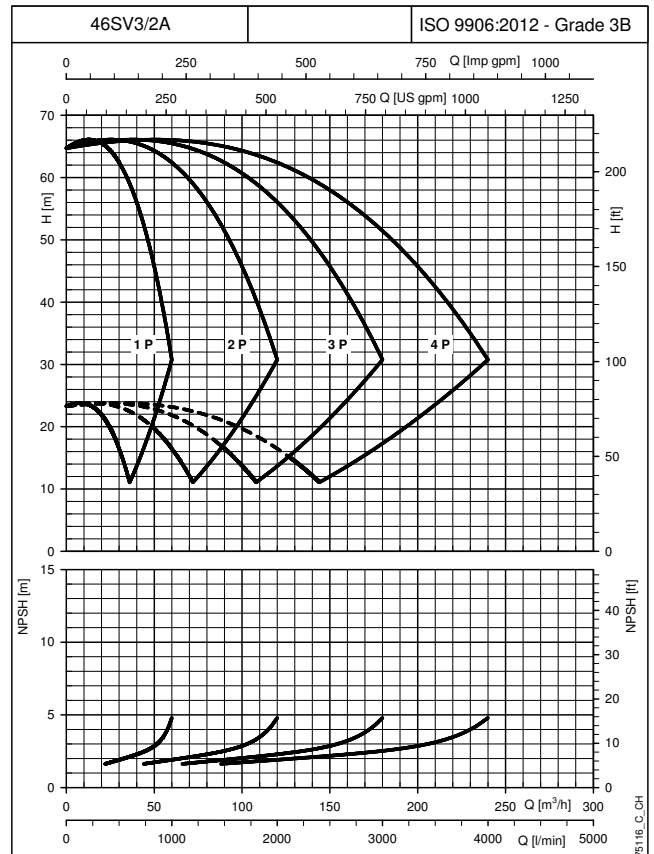
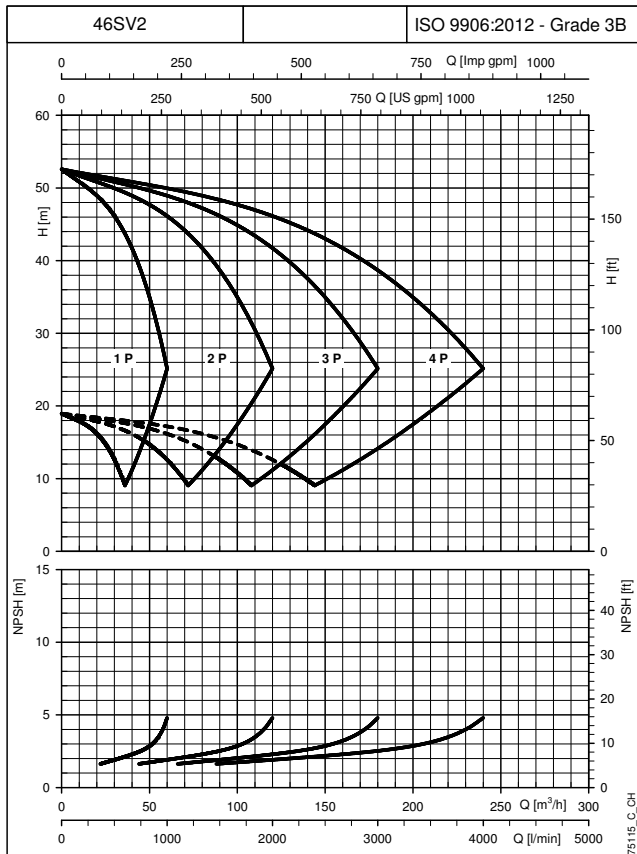
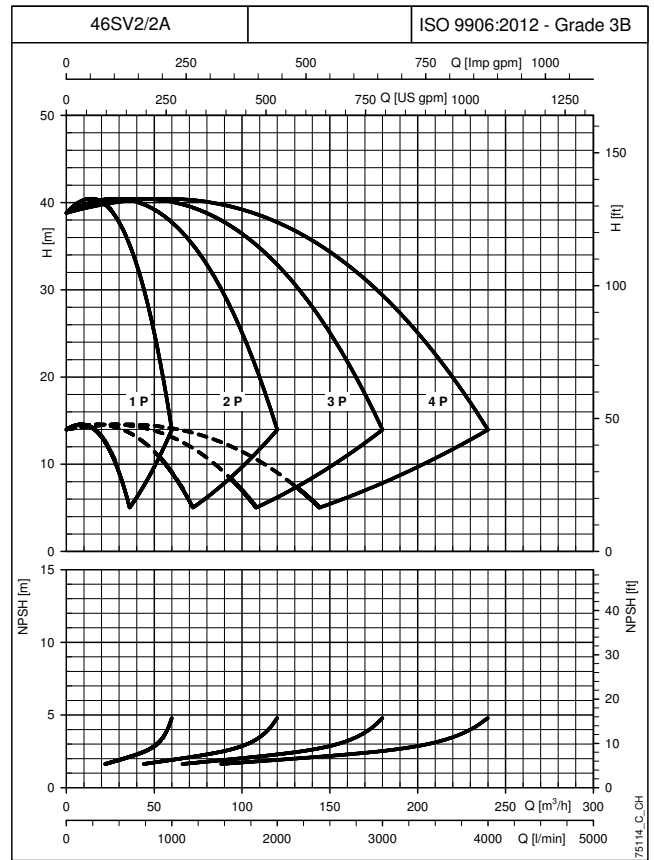
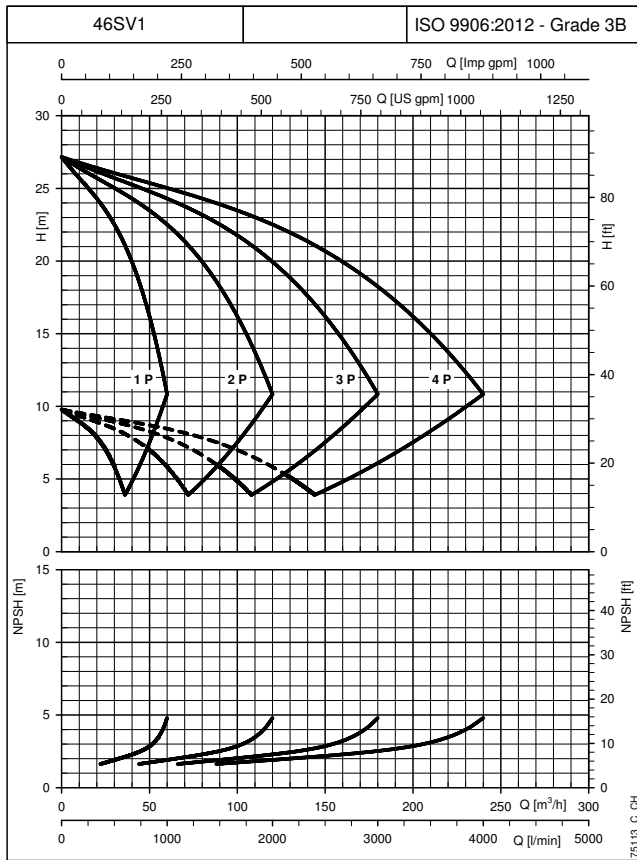

CURVES

The performance curves do not take into account flow resistance in the valves and piping. The curves show the performance with one, two, three and four pumps running. These performances are valid for liquids with density  $\rho = 1.0 \text{ Kg/dm}^3$  and kinematic viscosity  $\nu = 1 \text{ mm}^2/\text{sec}$ . The declared NPSH values are laboratory values; for practical use we recommend increasing these values by 0,5 m.

**GHV.../SV BOOSTER SETS SERIES  
OPERATING CHARACTERISTICS AT 30..50 Hz**

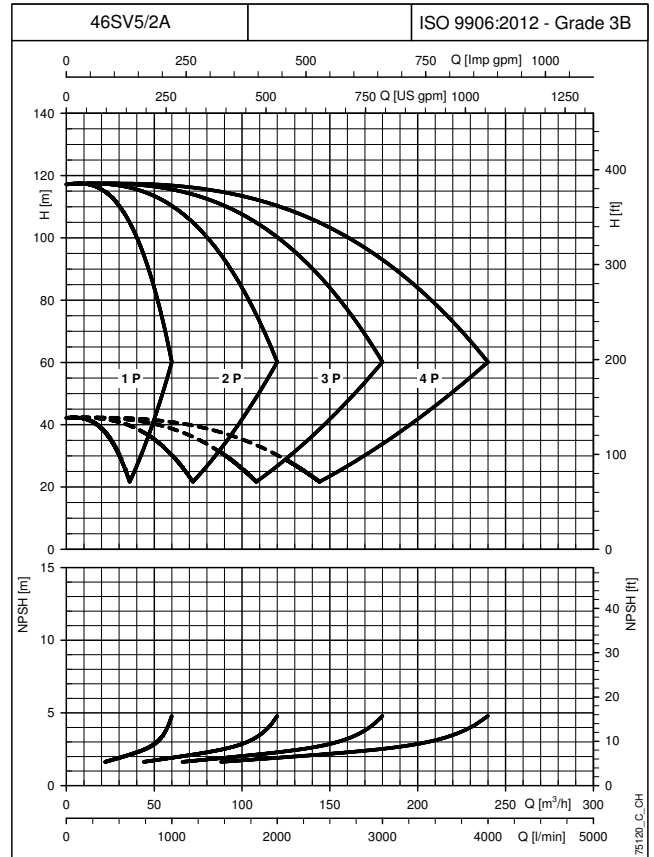
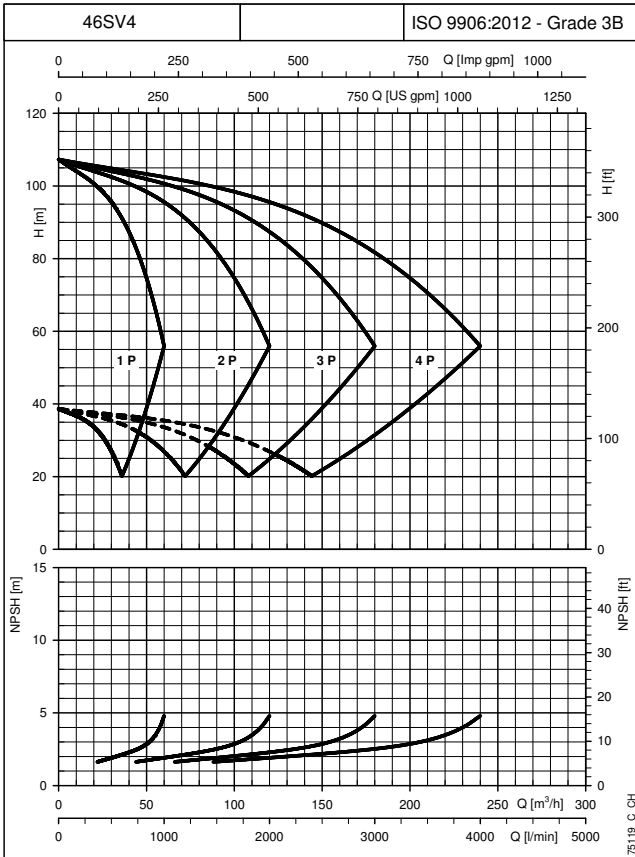
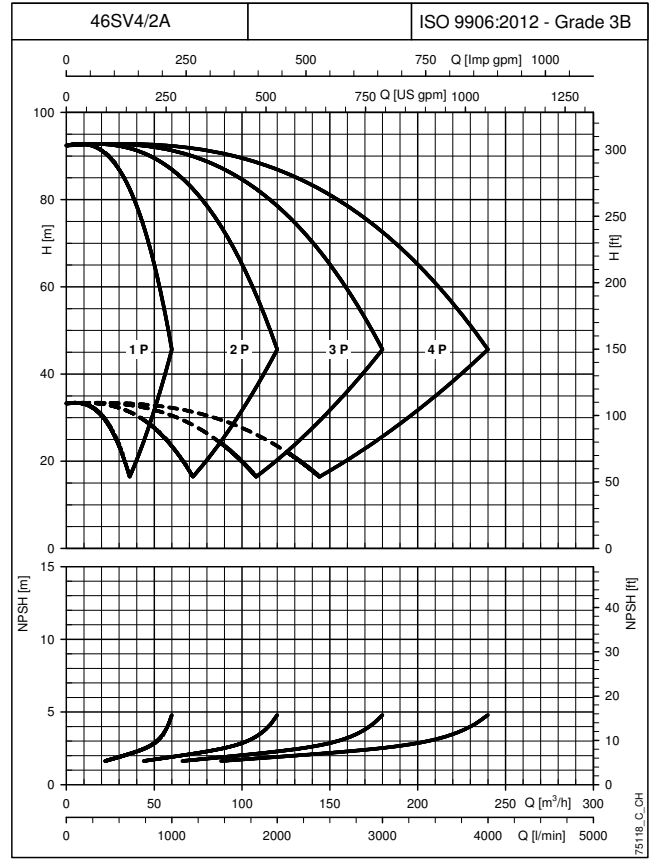
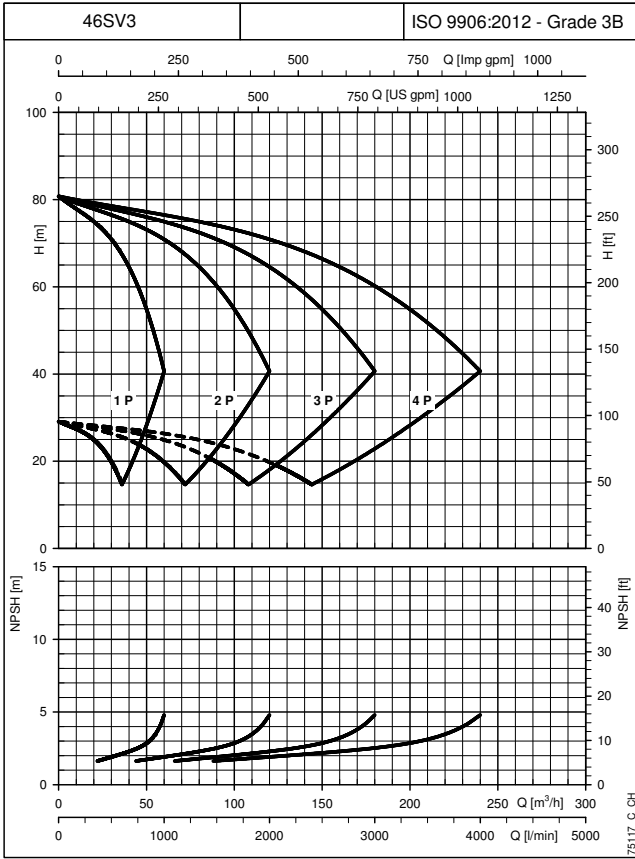

**CURVES**

The performance curves do not take into account flow resistance in the valves and piping. The curves show the performance with one, two, three and four pumps running. These performances are valid for liquids with density  $\rho = 1.0 \text{ Kg/dm}^3$  and kinematic viscosity  $\nu = 1 \text{ mm}^2/\text{sec}$ . The declared NPSH values are laboratory values; for practical use we recommend increasing these values by 0,5 m.

# GHV.../SV BOOSTER SETS SERIES OPERATING CHARACTERISTICS AT 30..50 Hz

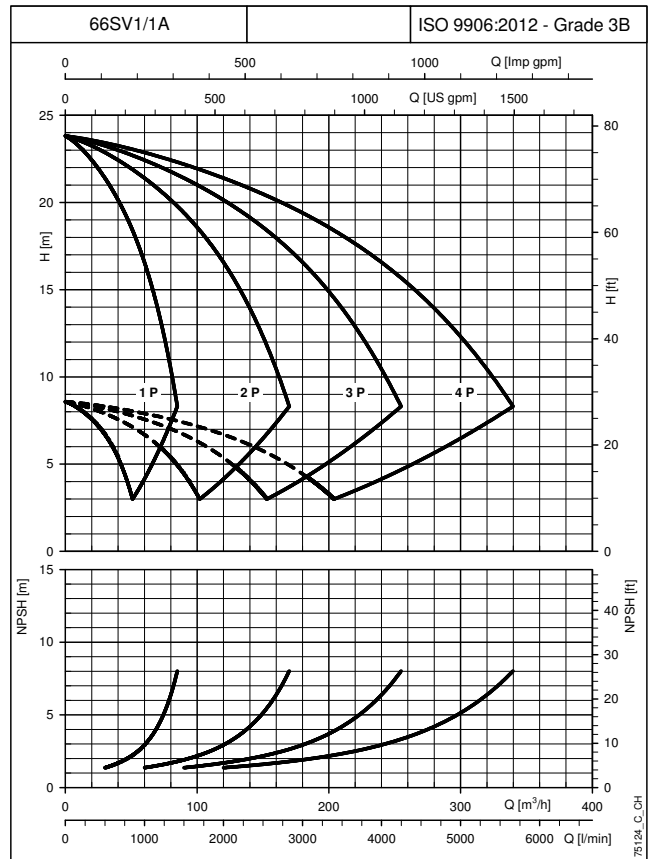
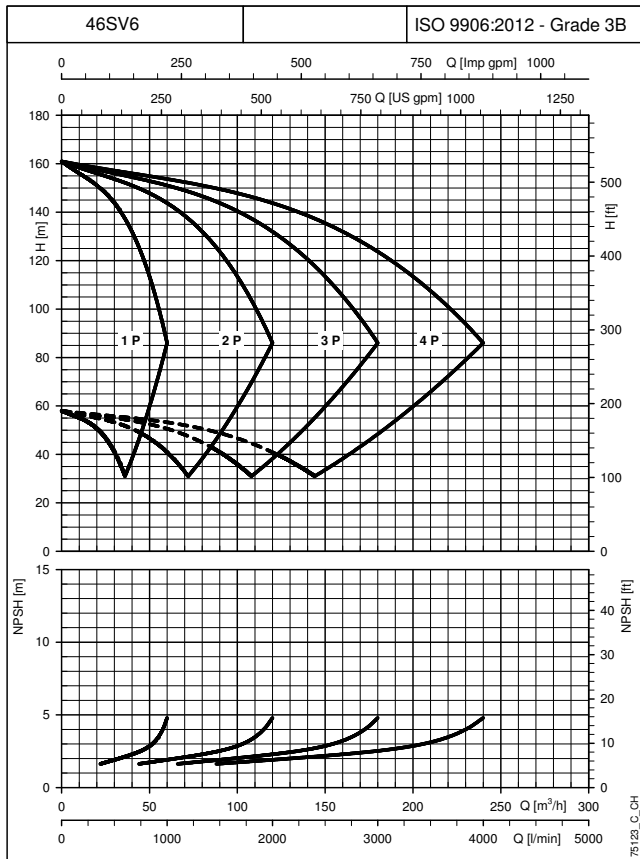
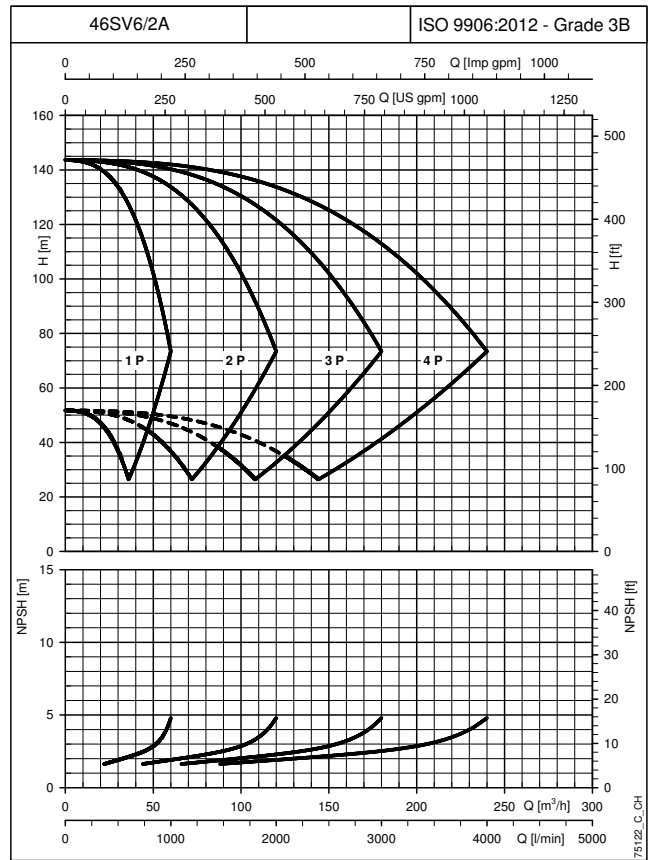
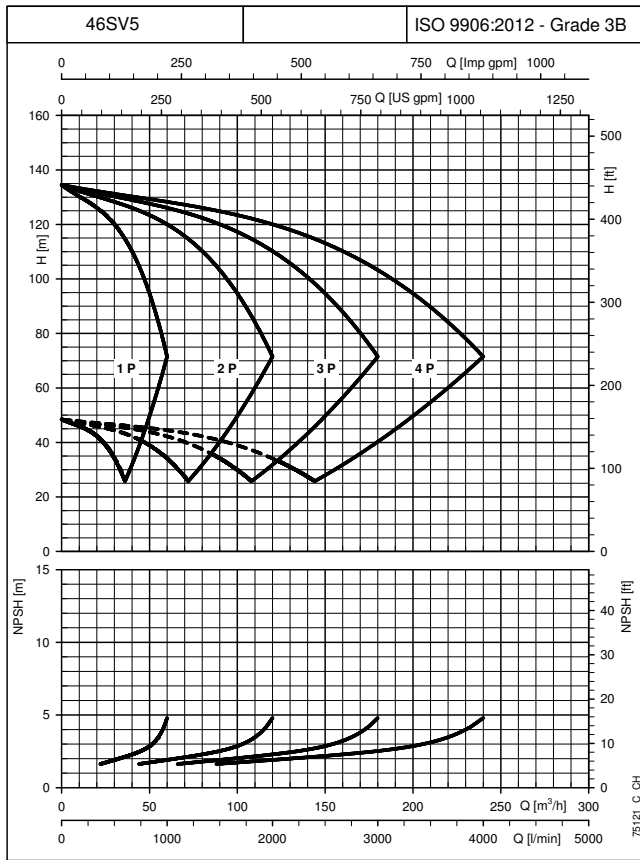

**CURVES**

The performance curves do not take into account flow resistance in the valves and piping. The curves show the performance with one, two, three and four pumps running. These performances are valid for liquids with density  $\rho = 1.0 \text{ Kg/dm}^3$  and kinematic viscosity  $\nu = 1 \text{ mm}^2/\text{sec}$ . The declared NPSH values are laboratory values; for practical use we recommend increasing these values by 0,5 m.

## GHV.../SV BOOSTER SETS SERIES OPERATING CHARACTERISTICS AT 30..50 Hz

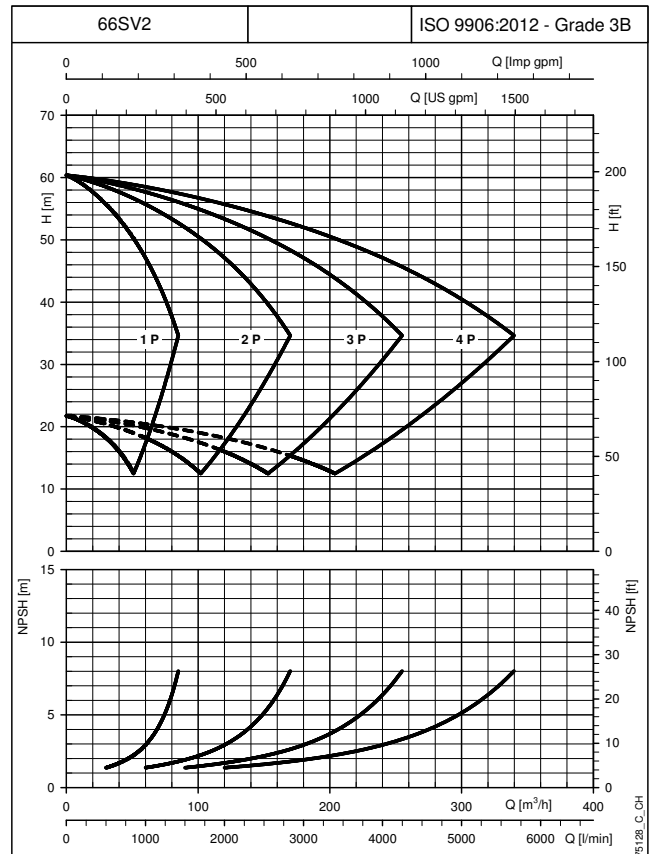
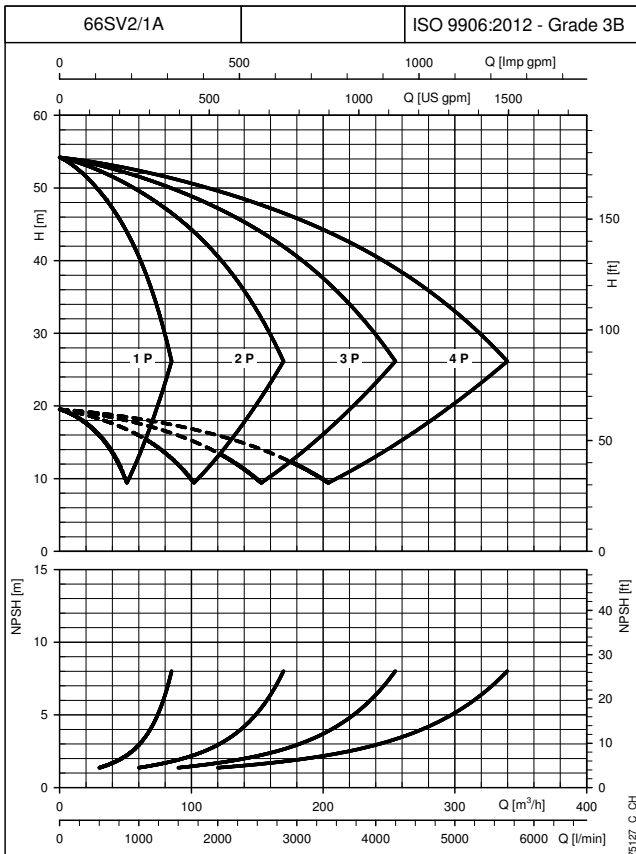
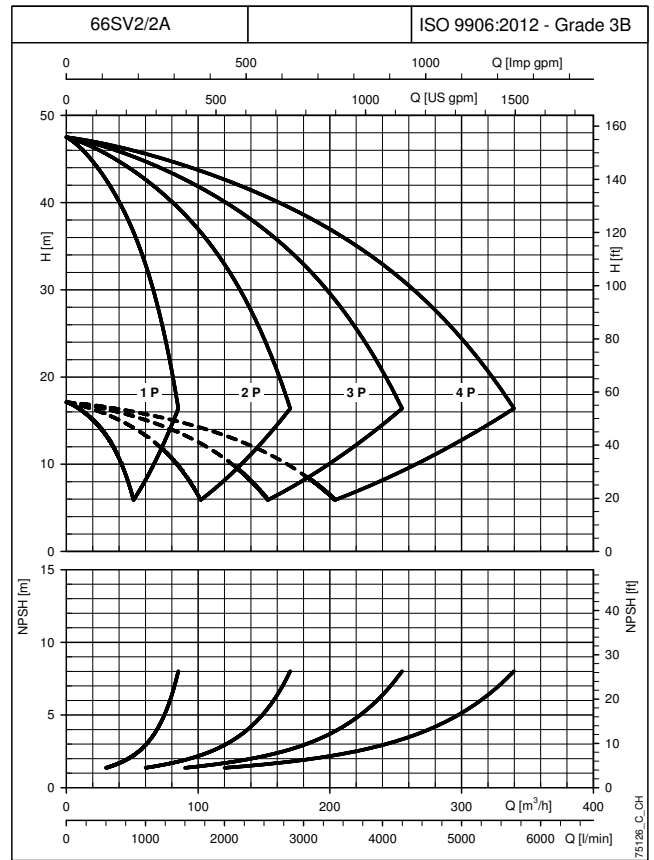
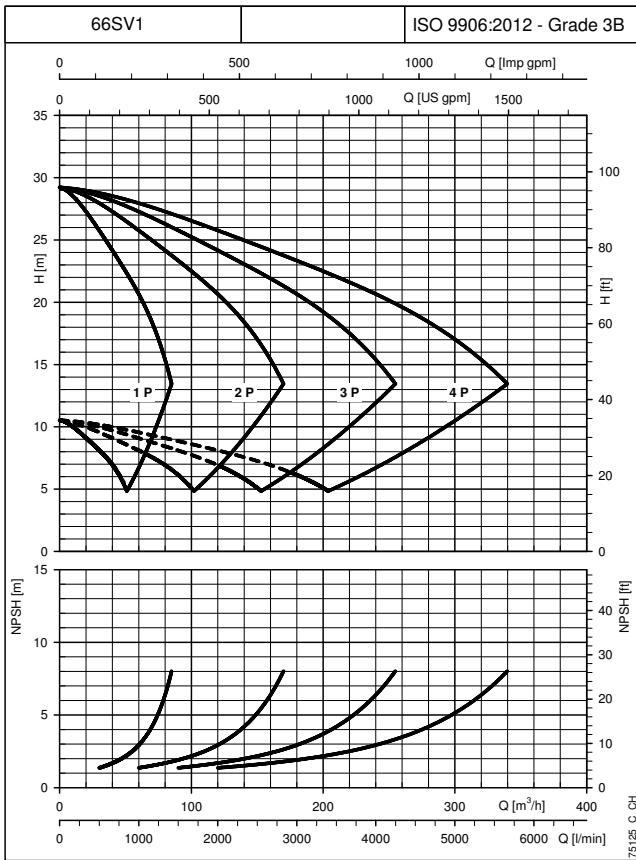

**CURVES**

The performance curves do not take into account flow resistance in the valves and piping. The curves show the performance with one, two, three and four pumps running. These performances are valid for liquids with density  $\rho = 1.0 \text{ Kg/dm}^3$  and kinematic viscosity  $\nu = 1 \text{ mm}^2/\text{sec}$ . The declared NPSH values are laboratory values; for practical use we recommend increasing these values by 0,5 m.

## GHV.../SV BOOSTER SETS SERIES OPERATING CHARACTERISTICS AT 30..50 Hz

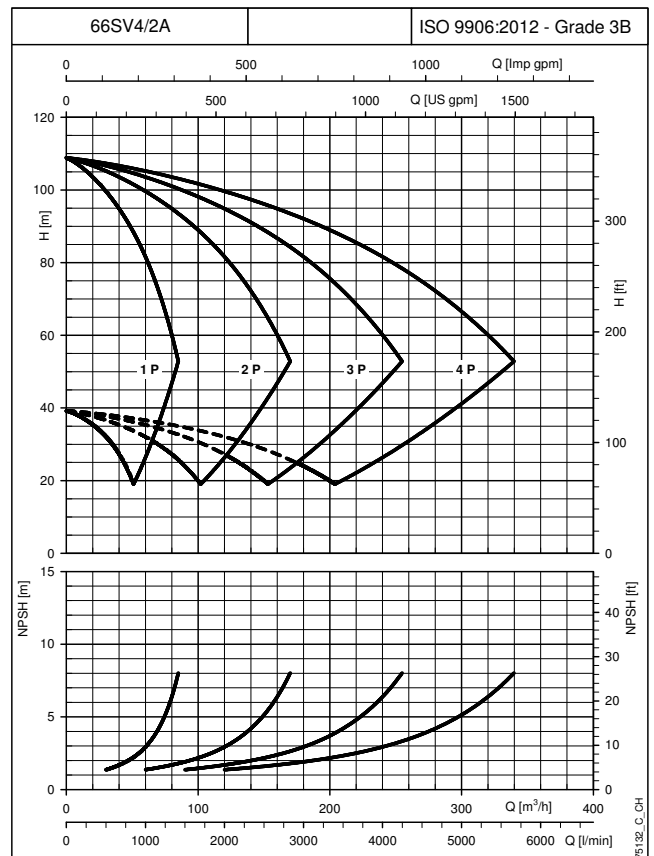
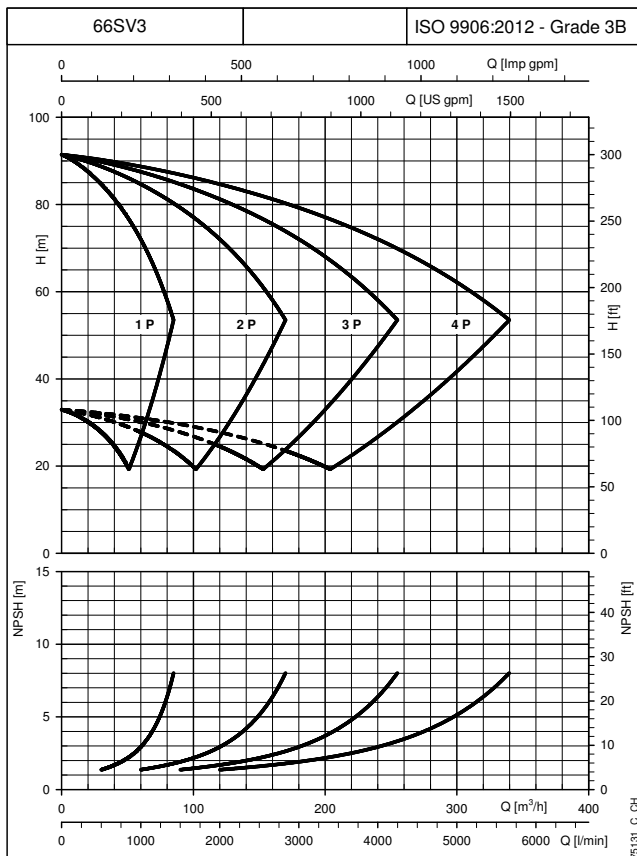
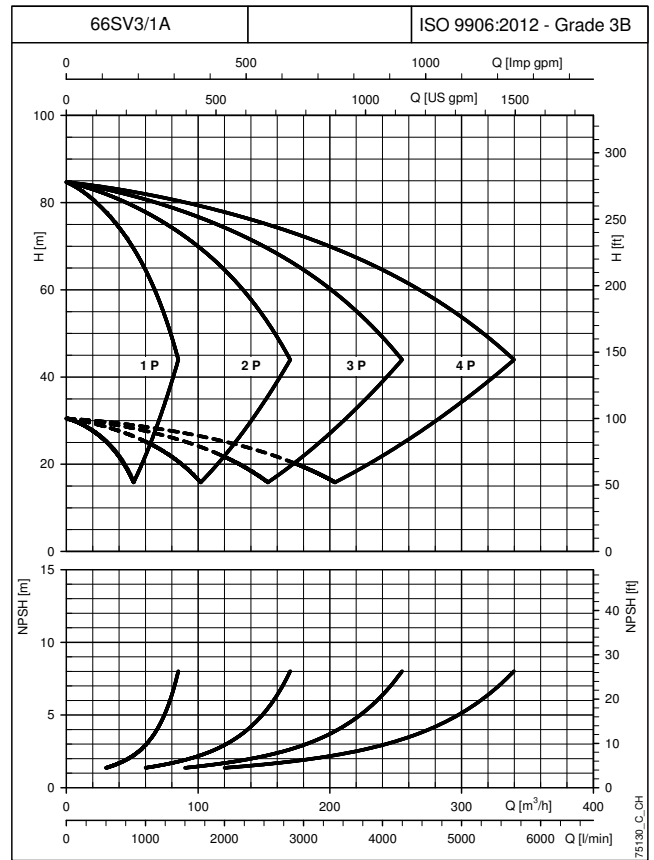
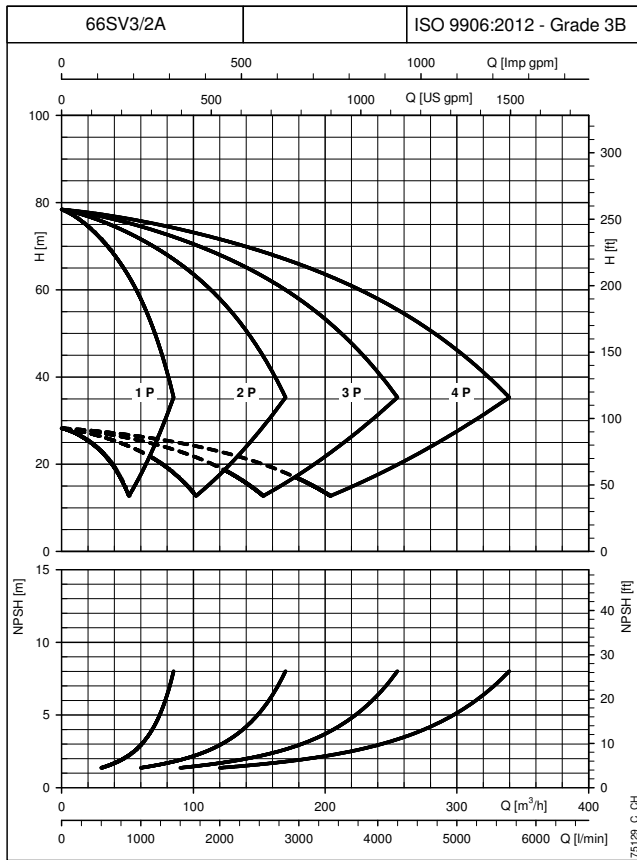

CURVES

The performance curves do not take into account flow resistance in the valves and piping. The curves show the performance with one, two, three and four pumps running. These performances are valid for liquids with density  $\rho = 1.0 \text{ Kg/dm}^3$  and kinematic viscosity  $\nu = 1 \text{ mm}^2/\text{sec}$ . The declared NPSH values are laboratory values; for practical use we recommend increasing these values by 0,5 m.

**GHV.../SV BOOSTER SETS SERIES  
OPERATING CHARACTERISTICS AT 30..50 Hz**

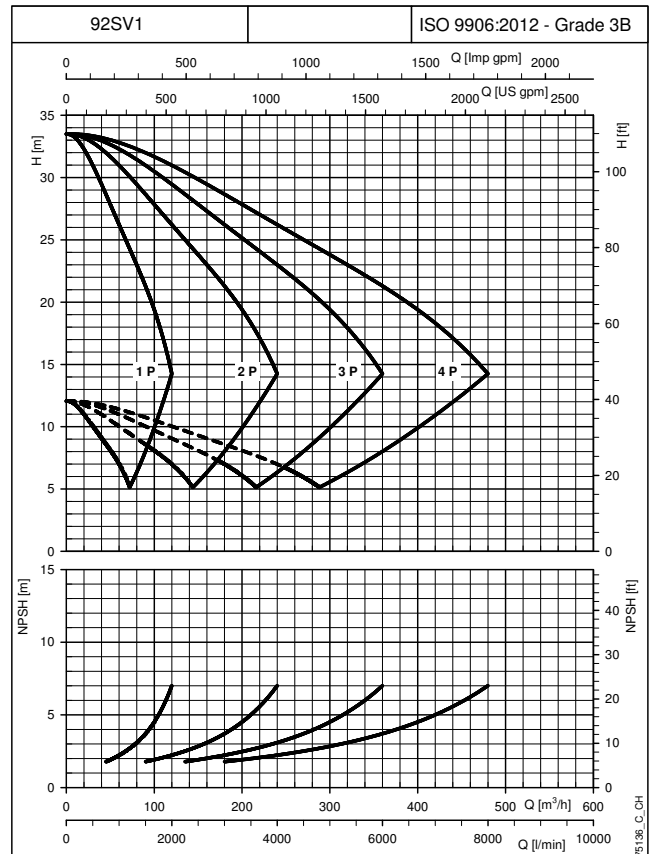
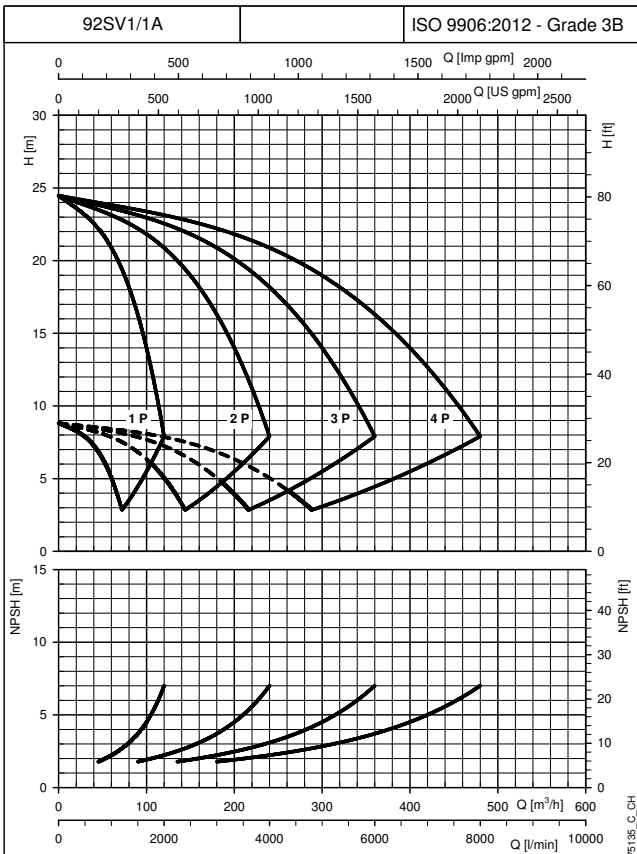
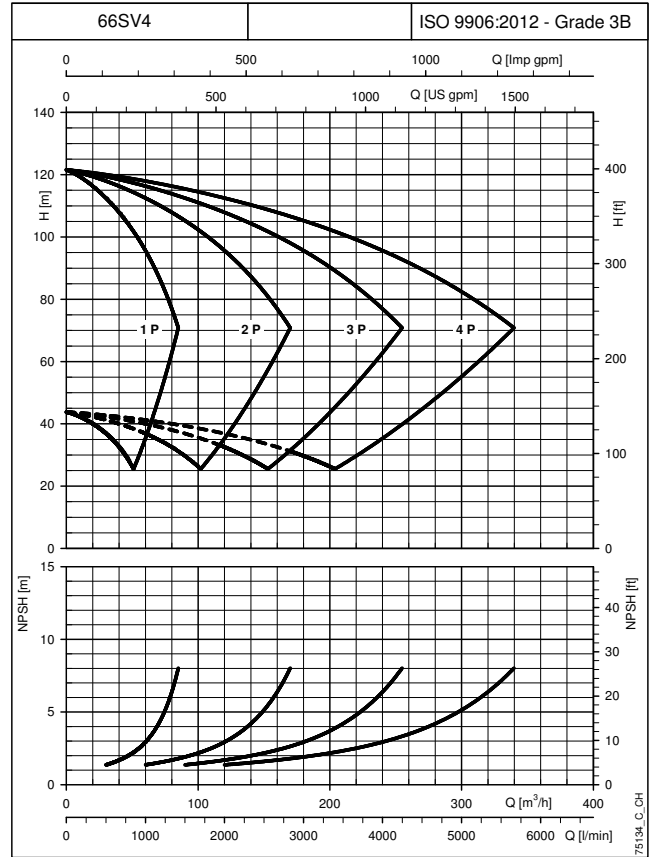
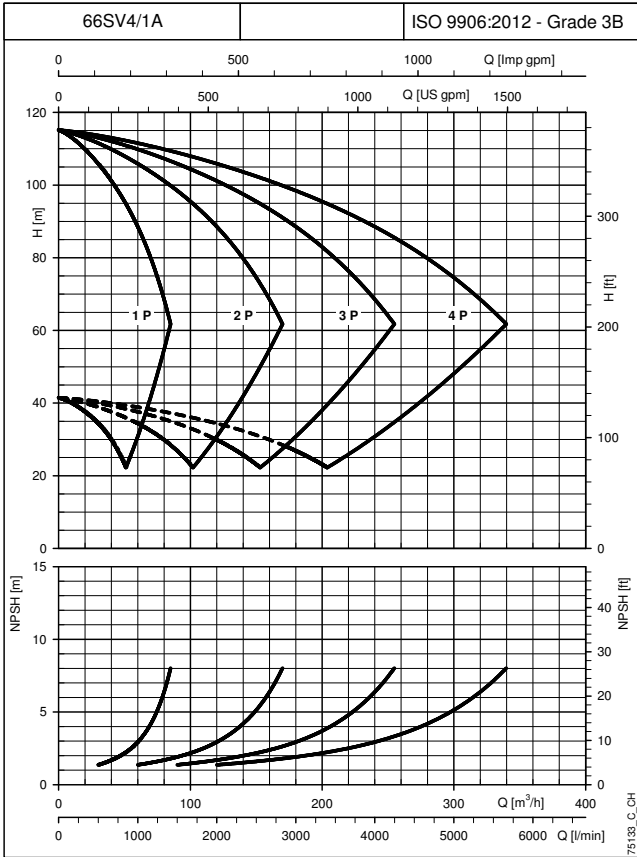

**CURVES**

The performance curves do not take into account flow resistance in the valves and piping. The curves show the performance with one, two, three and four pumps running. These performances are valid for liquids with density  $\rho = 1.0 \text{ Kg/dm}^3$  and kinematic viscosity  $\nu = 1 \text{ mm}^2/\text{sec}$ . The declared NPSH values are laboratory values; for practical use we recommend increasing these values by 0,5 m.

## GHV.../SV BOOSTER SETS SERIES OPERATING CHARACTERISTICS AT 30..50 Hz

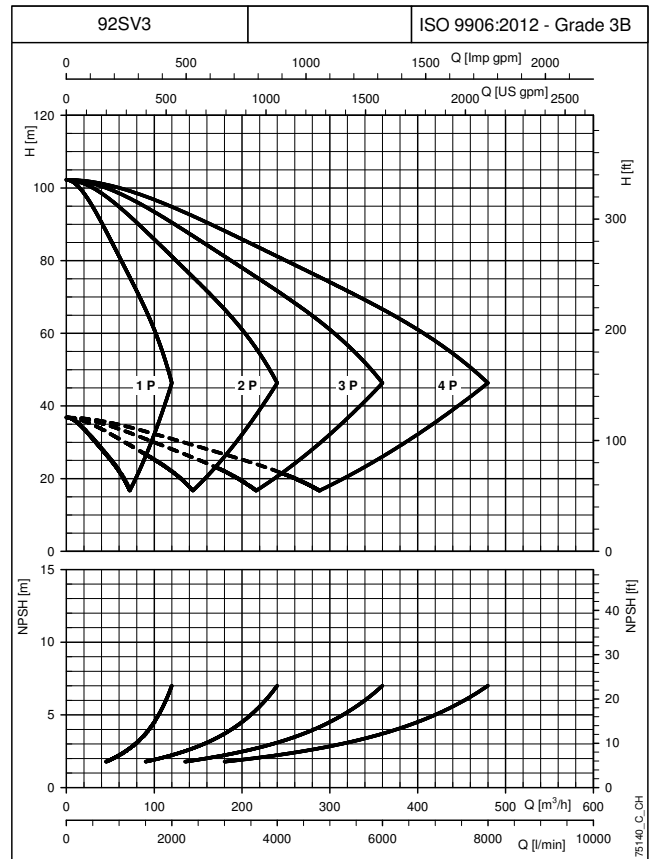
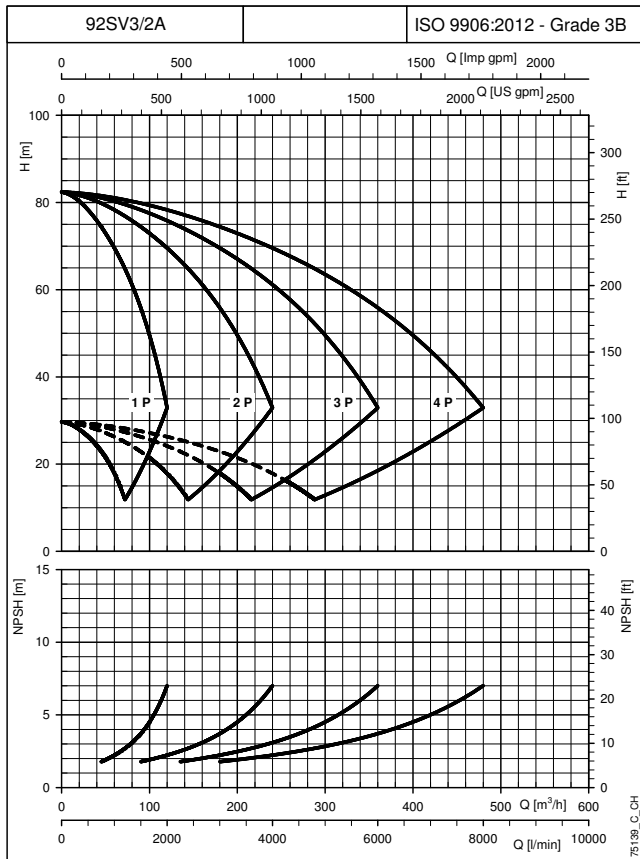
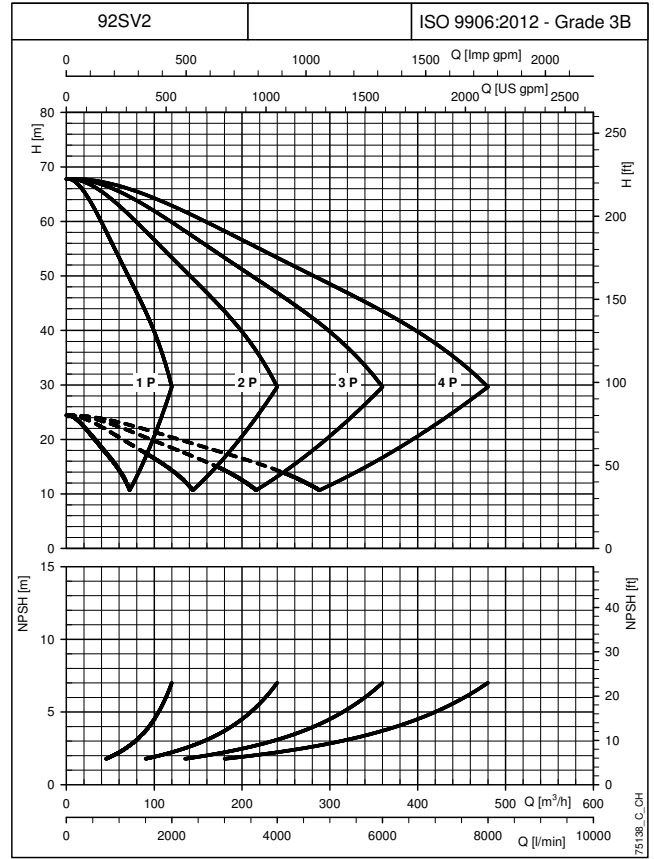
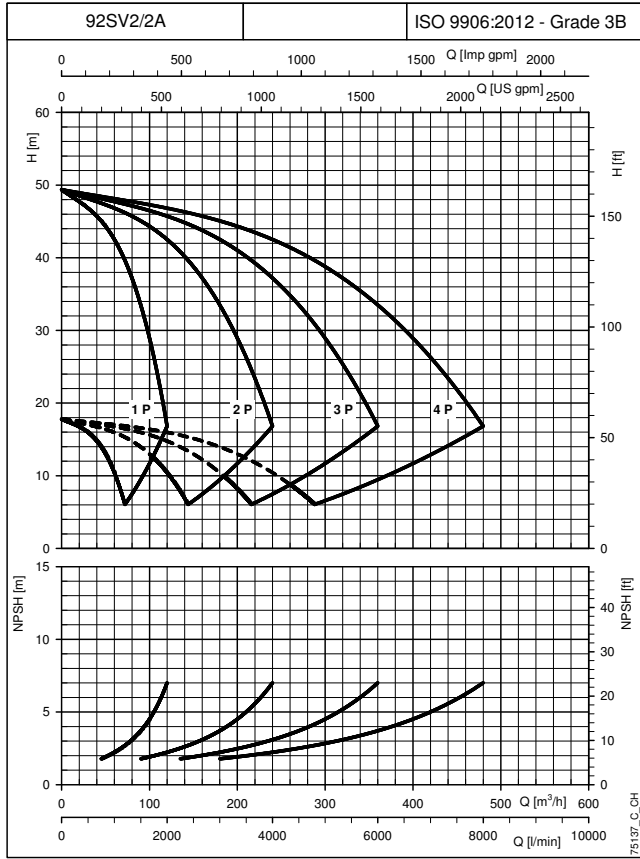

**CURVES**

The performance curves do not take into account flow resistance in the valves and piping. The curves show the performance with one, two, three and four pumps running. These performances are valid for liquids with density  $\rho = 1.0 \text{ Kg/dm}^3$  and kinematic viscosity  $\nu = 1 \text{ mm}^2/\text{sec}$ . The declared NPSH values are laboratory values; for practical use we recommend increasing these values by 0,5 m.



## GHV.../SV BOOSTER SETS SERIES OPERATING CHARACTERISTICS AT 30..50 Hz

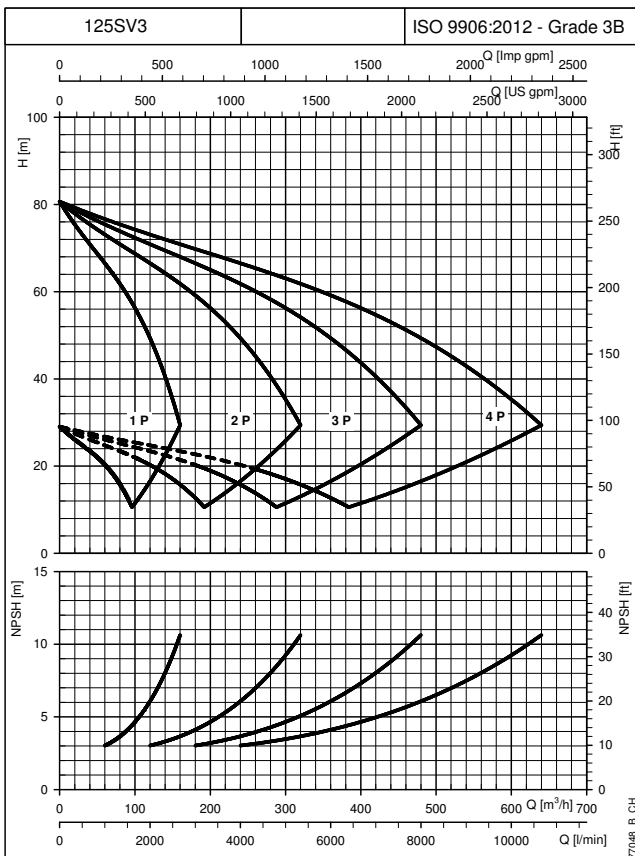
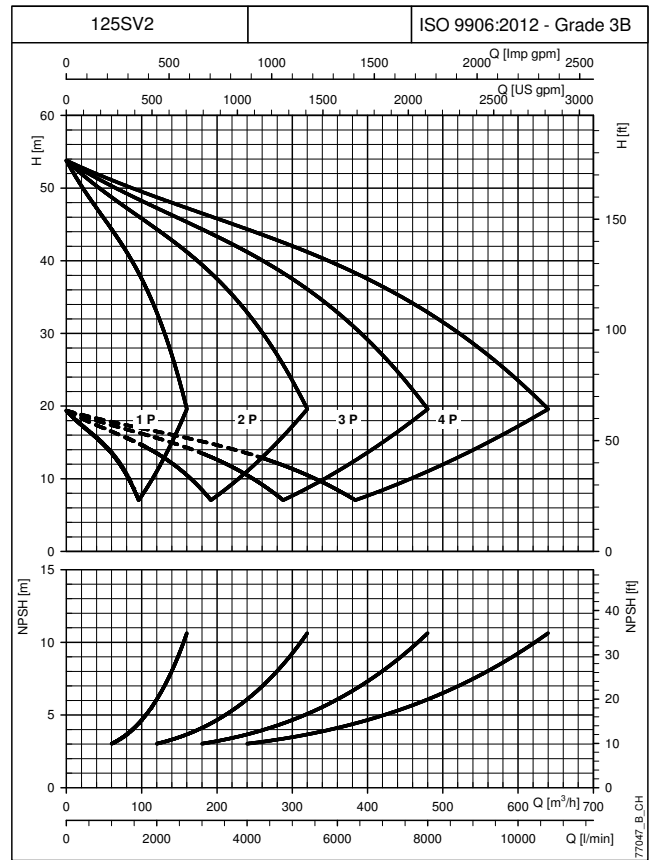
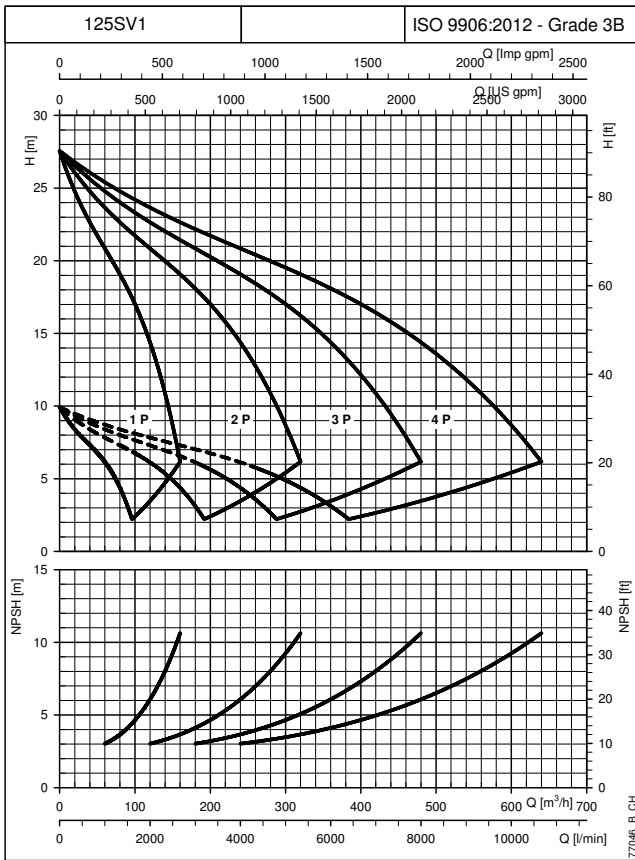

CURVES

The performance curves do not take into account flow resistance in the valves and piping. The curves show the performance with one, two, three and four pumps running. These performances are valid for liquids with density  $\rho = 1.0 \text{ Kg/dm}^3$  and kinematic viscosity  $\nu = 1 \text{ mm}^2/\text{sec}$ . The declared NPSH values are laboratory values; for practical use we recommend increasing these values by 0,5 m.

### GHV./SV BOOSTER SETS SERIES HC PRESSURE DROP CURVE

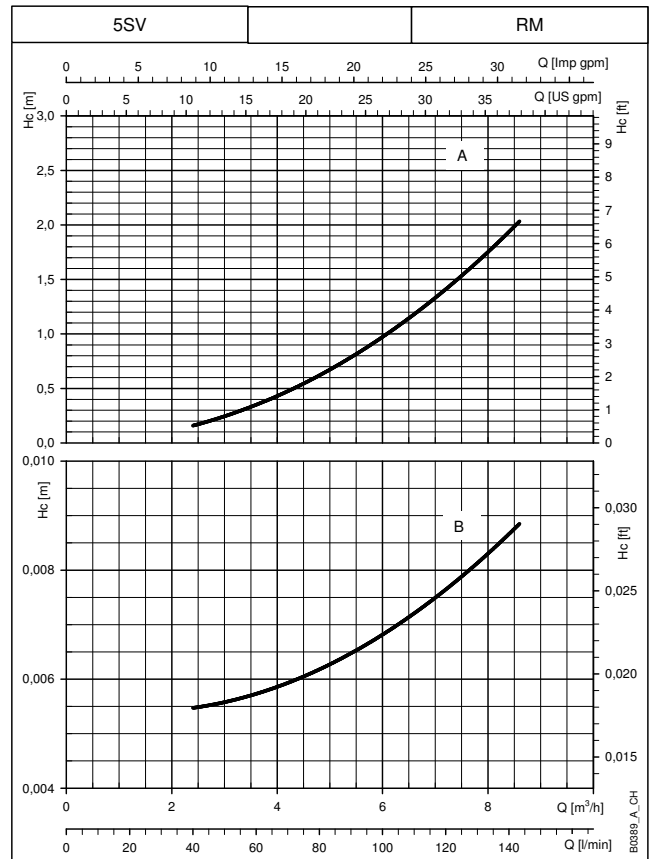
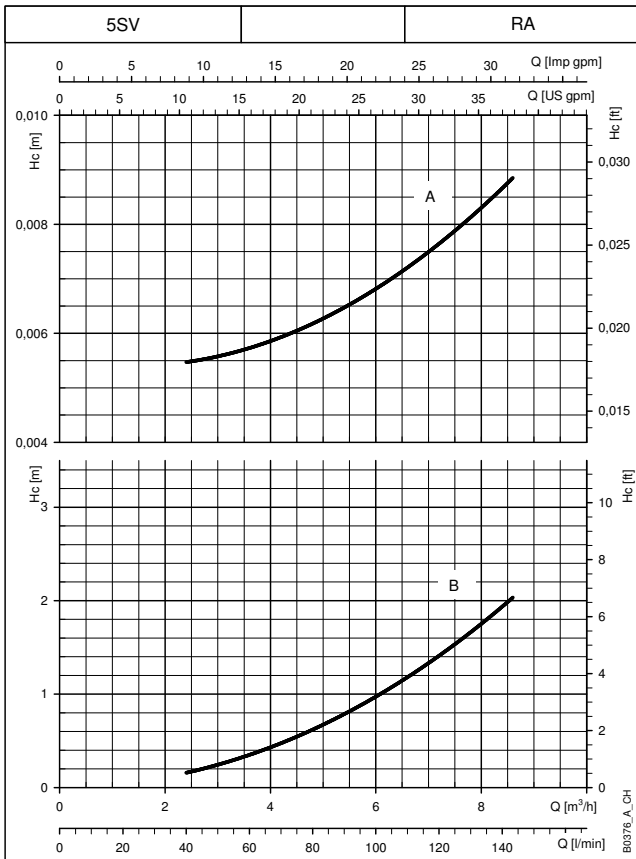
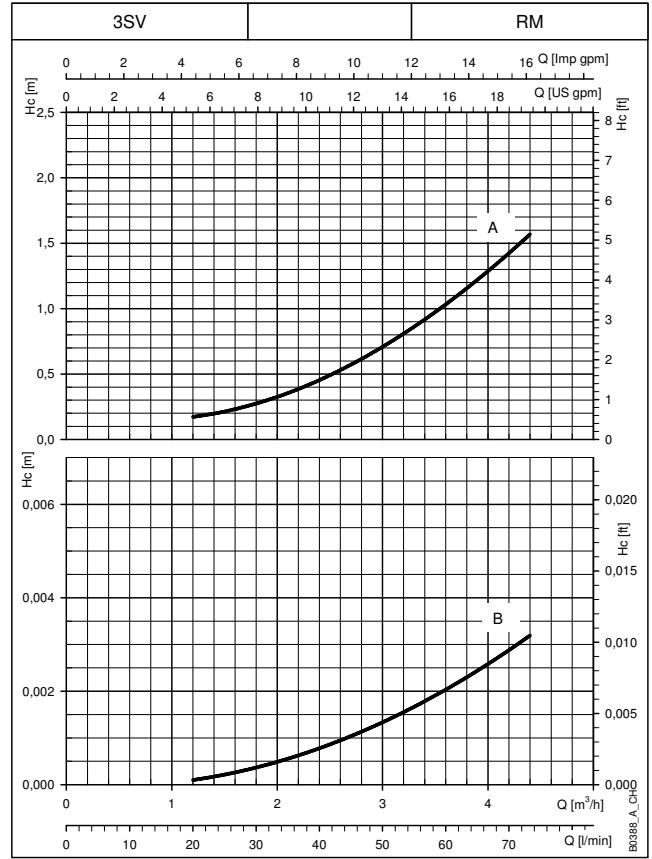
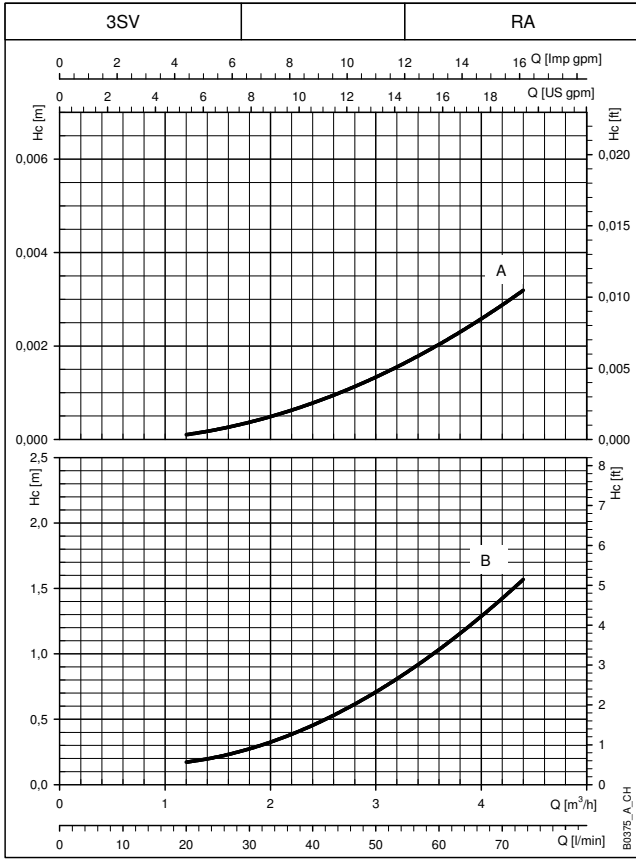

CURVES

The declared curves are valid for liquids with density  $\rho = 1 \text{ Kg/dm}^3$  and kinematic viscosity  $\nu = 1 \text{ mm}^2/\text{sec}$ .  
 Hc (A): Pressure drop curve on delivery side of the pump. Hc (B): Pressure drop curve on suction side of the pump.  
 RA: check valve on suction side. RM: check valve on delivery side.  
 The pressure drops do not consider the distributed pressure drops on the manifold.

### GHV./SV BOOSTER SETS SERIES HC PRESSURE DROP CURVE

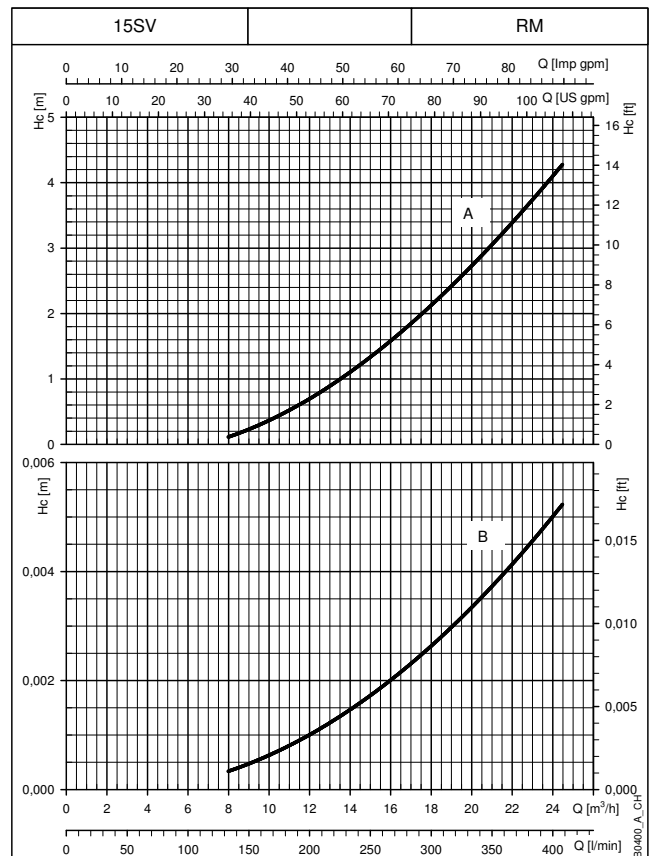
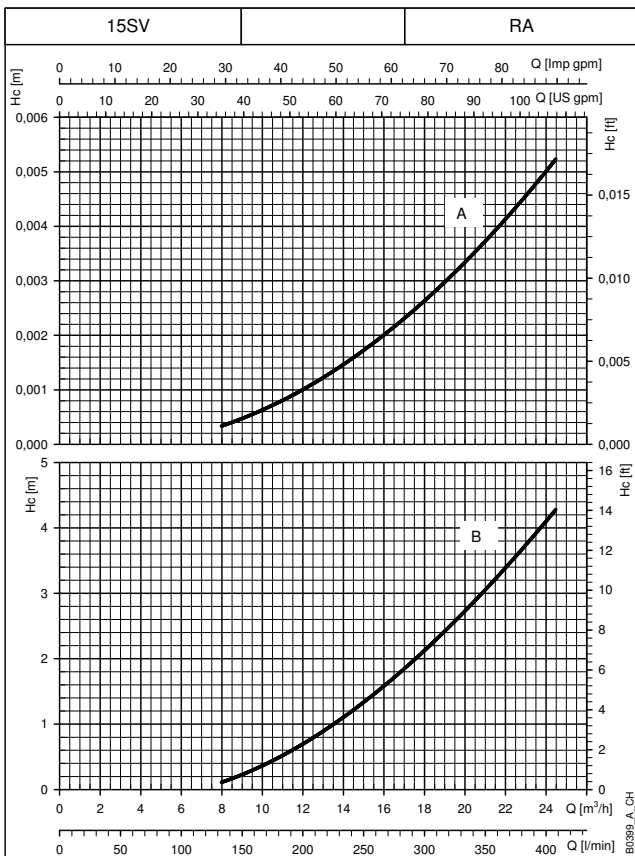
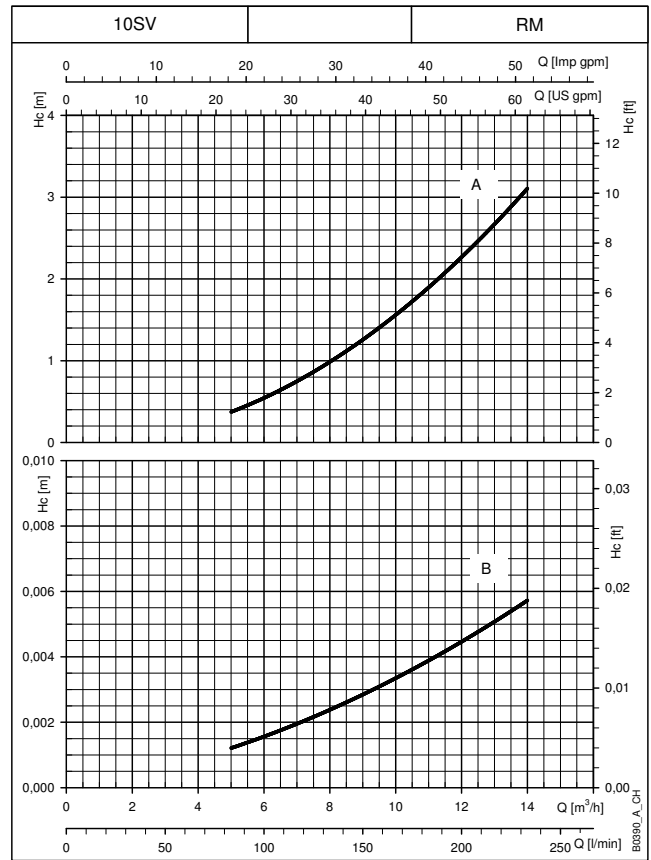
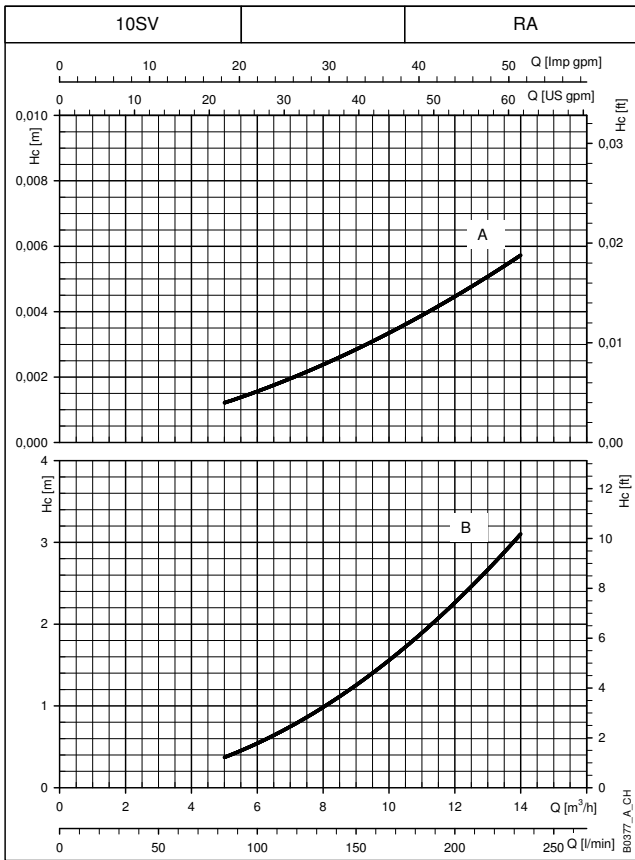

The declared curves are valid for liquids with density  $\rho = 1 \text{ Kg/dm}^3$  and kinematic viscosity  $\nu = 1 \text{ mm}^2/\text{sec}$ .  
 Hc (A): Pressure drop curve on delivery side of the pump. Hc (B): Pressure drop curve on suction side of the pump.  
 RA: check valve on suction side. RM: check valve on delivery side.  
 The pressure drops do not consider the distributed pressure drops on the manifold.

**CURVES**

## GHV./SV BOOSTER SETS SERIES HC PRESSURE DROP CURVE

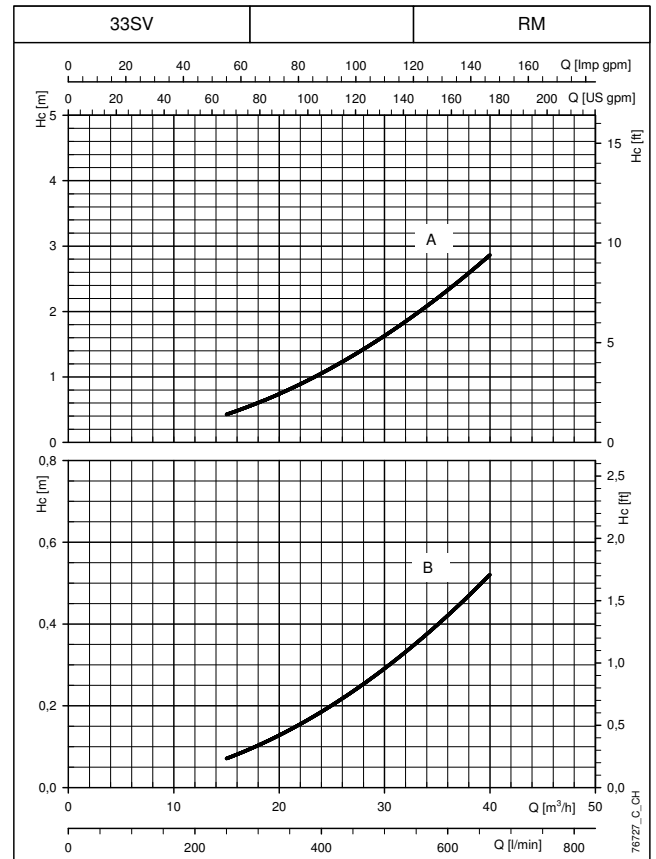
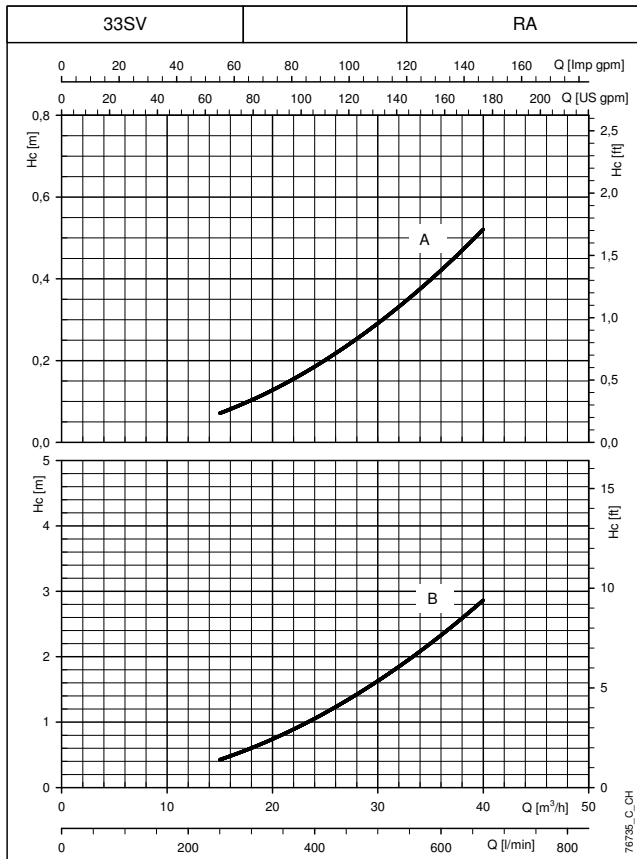
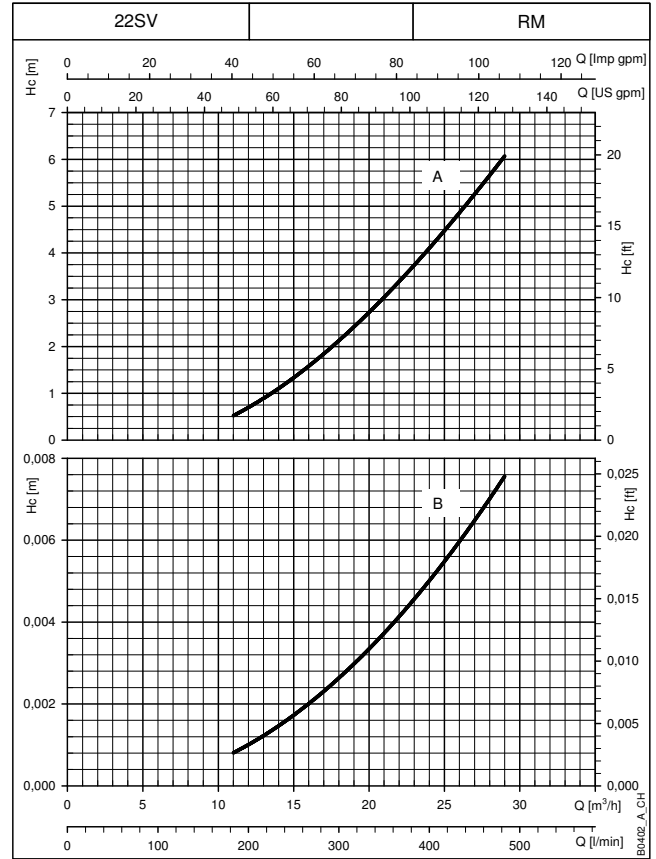
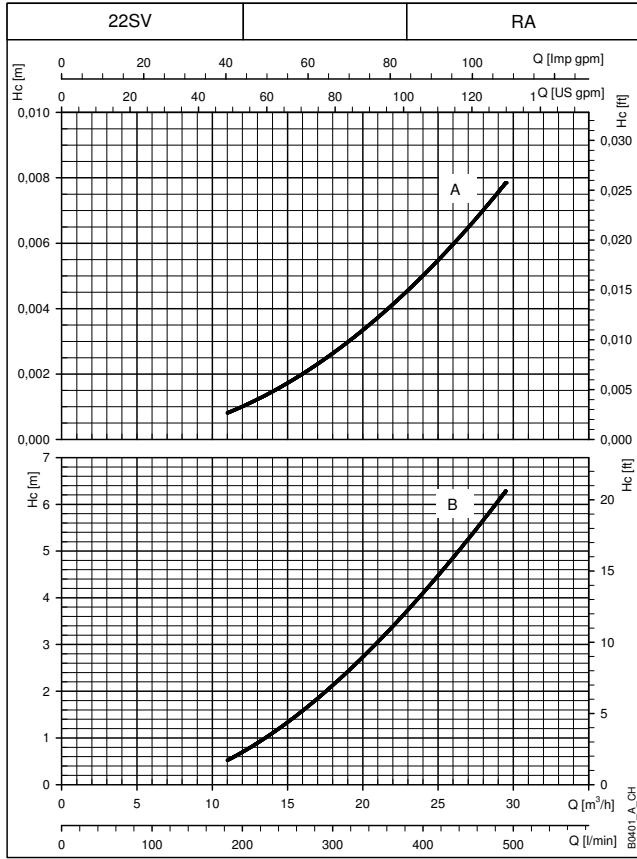

CURVES

The declared curves are valid for liquids with density  $\rho = 1 \text{ Kg/dm}^3$  and kinematic viscosity  $\nu = 1 \text{ mm}^2/\text{sec}$ .  
 Hc (A): Pressure drop curve on delivery side of the pump. Hc (B): Pressure drop curve on suction side of the pump.  
 RA: check valve on suction side. RM: check valve on delivery side.  
 The pressure drops do not consider the distributed pressure drops on the manifold.

### GHV./SV BOOSTER SETS SERIES HC PRESSURE DROP CURVE

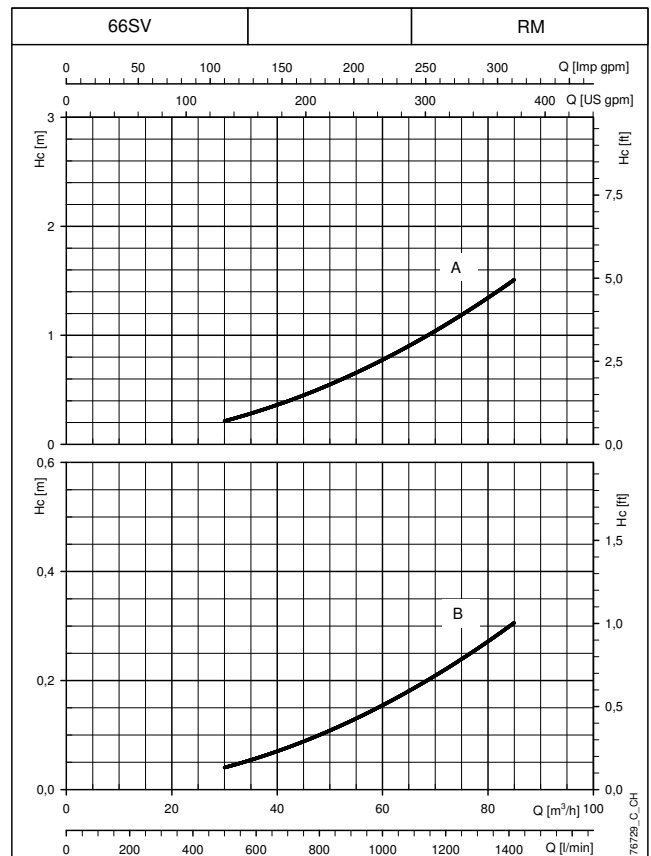
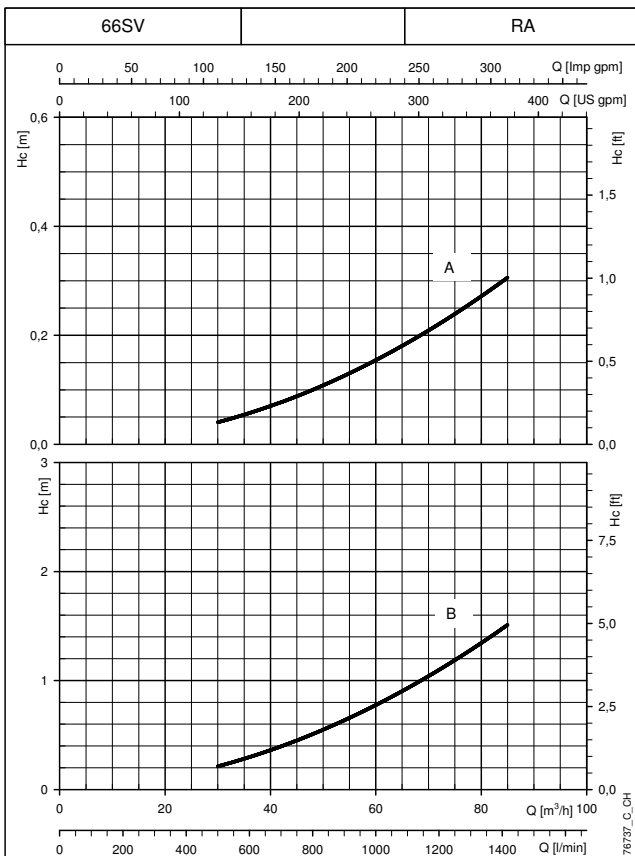
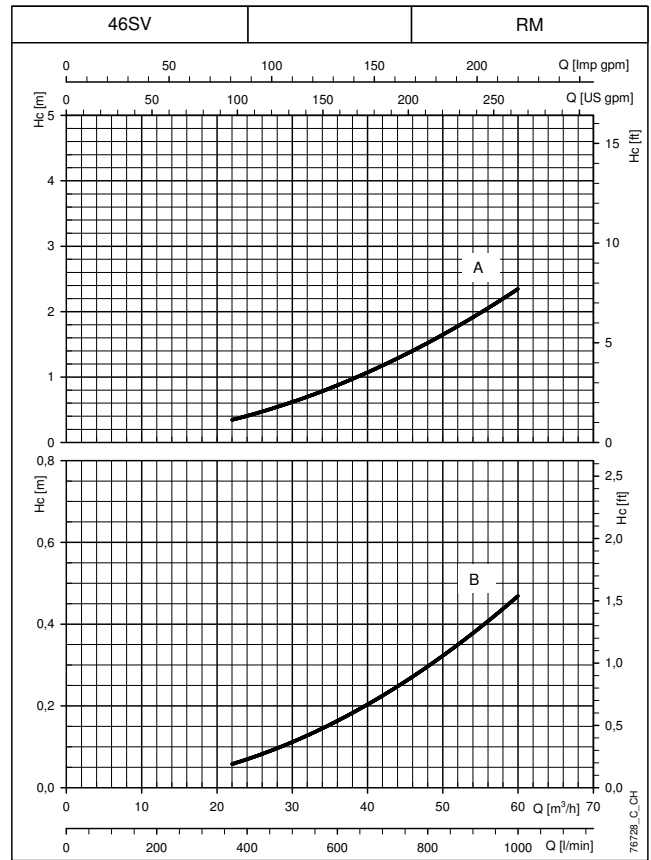
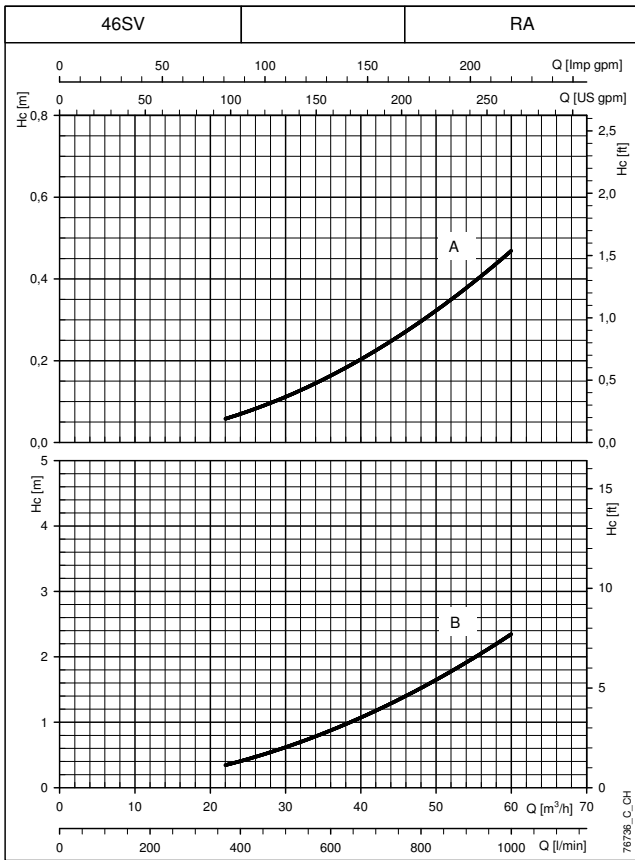

The declared curves are valid for liquids with density  $\rho = 1 \text{ Kg/dm}^3$  and kinematic viscosity  $\nu = 1 \text{ mm}^2/\text{sec}$ .  
 Hc (A): Pressure drop curve on delivery side of the pump. Hc (B): Pressure drop curve on suction side of the pump.  
 RA: check valve on suction side. RM: check valve on delivery side.  
 The pressure drops do not consider the distributed pressure drops on the manifold.

**CURVES**

### GHV./SV BOOSTER SETS SERIES HC PRESSURE DROP CURVE

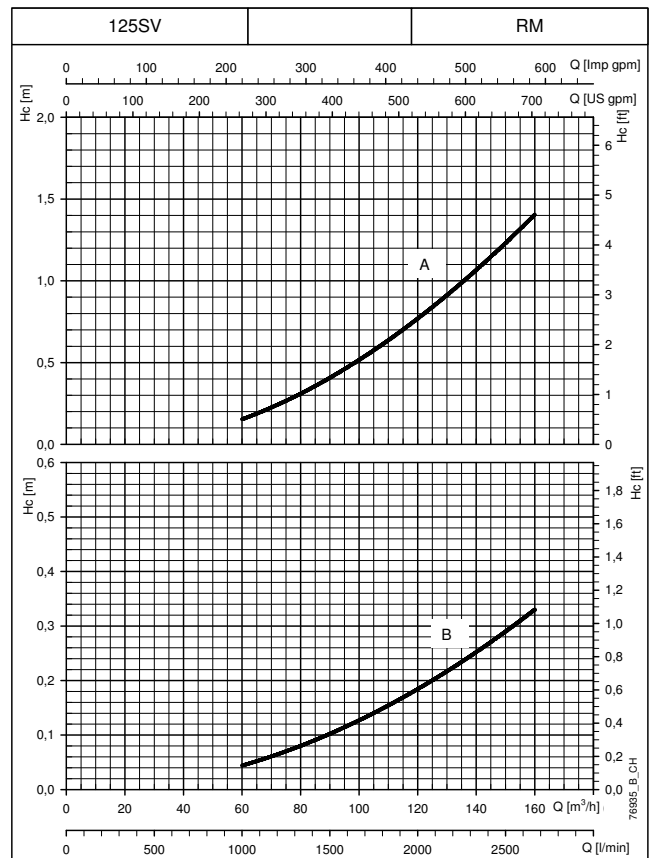
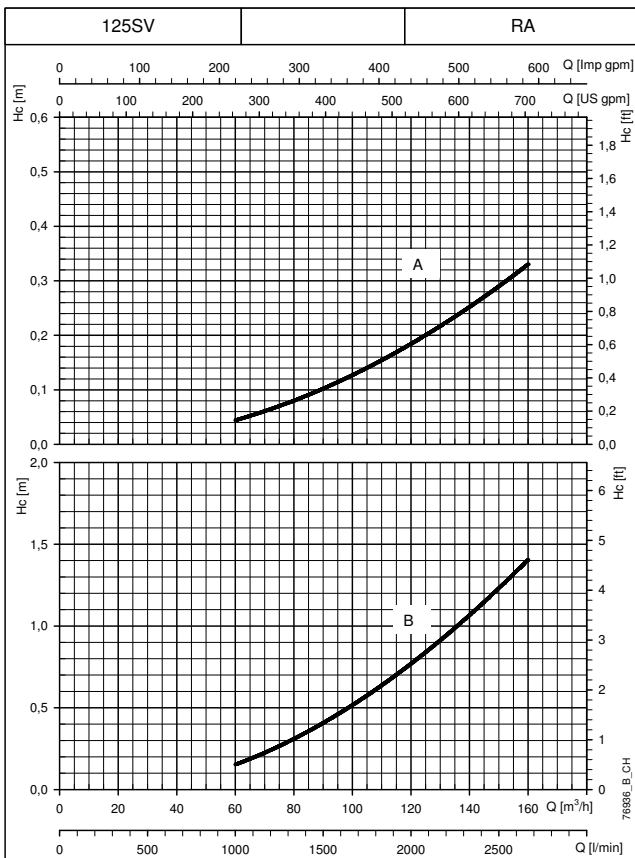
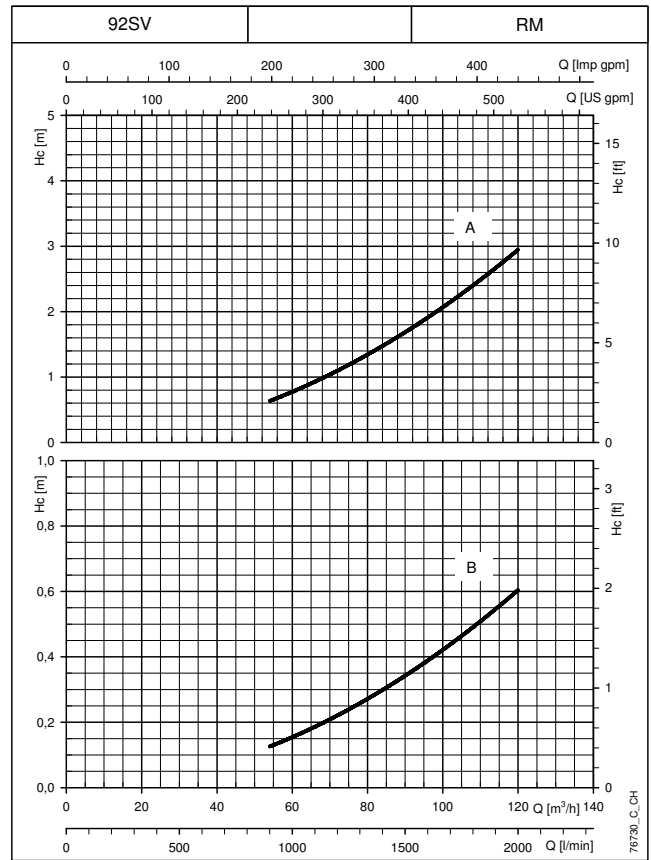
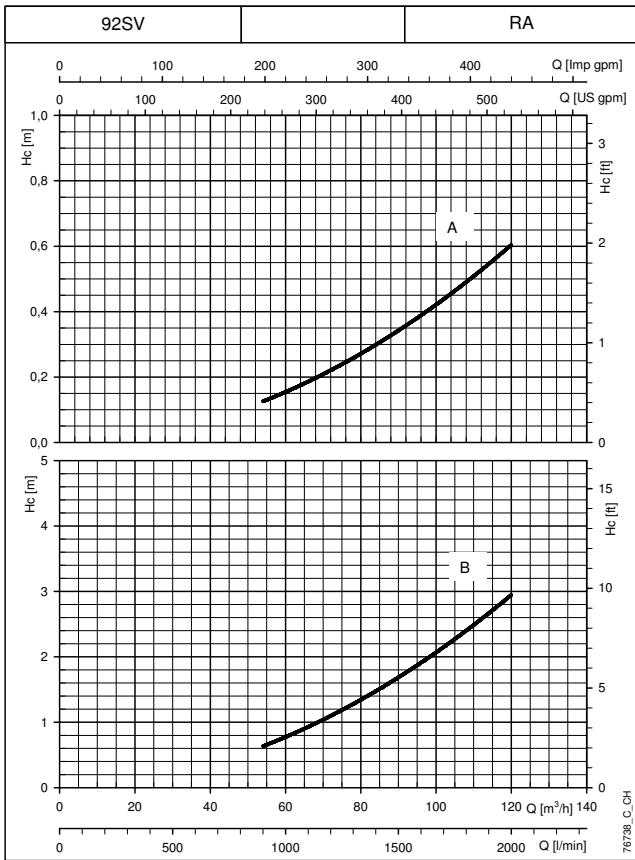

CURVES

The declared curves are valid for liquids with density  $\rho = 1 \text{ Kg/dm}^3$  and kinematic viscosity  $\nu = 1 \text{ mm}^2/\text{sec}$ .  
 Hc (A): Pressure drop curve on delivery side of the pump. Hc (B): Pressure drop curve on suction side of the pump.  
 RA: check valve on suction side. RM: check valve on delivery side.  
 The pressure drops do not consider the distributed pressure drops on the manifold.

# ACCESSORIES

## DIAPHRAGM TANK KITS

Booster sets have delivery manifolds with attachments for the installation of 8 or 24 litre diaphragm vessels (hydro tube). Each manifold has a number of attachments equal to the number of pumps of the set.

The caps for sealing any unused attachments are supplied with the set. Any large size tanks can be connected to the unused end of the delivery manifold. For proper sizing of the tank, please refer to the technical appendix.

Kits featuring the following accessories **are available on request**:

- Diaphragm tank.
- On-off valve.
- instructions sheet.
- packing.

Volume Litres	PN bar	DIMENSIONS (mm)			Materials		
		ø A	B	Valve	Diaphragm	Vessel	Valve
8	8	205	390	1" FF	EPDM	Painted steel	Nickel-plated brass
24	8	270	555	1" FF	EPDM	Painted steel	Nickel-plated brass
24	10	270	555	1" FF	EPDM	Painted steel	Nickel-plated brass
24	16	270	555	1" FF	EPDM	Painted steel	Nickel-plated brass
24	10	270	575	1" FF	Butyl	Stainless steel	AISI 316 stainless steel
20	25	270	555	1" FF	EPDM	Painted steel	Nickel-plated brass

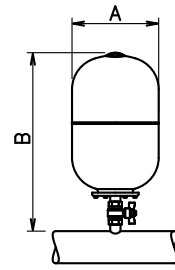

DET-VASI\_A\_DD

Gcom-vmb-en\_c\_td

## FLANGE KIT

Manifolds up to 3" are supplied with threaded attachments and caps for sealing the unused ends.

For these manifolds, stainless steel AISI 304 or 316 flanges for connection to the system are available on request.

## THREADED COUNTERFLANGES

KIT TYPE	DN	ø C	DIMENSIONS (mm)				HOLES			PN
			ø A	B	ø D	H	ø F	N°		
2"	50	Rp 2	125	16	165	24	18	4	25	
2" 1/2	65	Rp 2 1/2	145	16	185	23	18	4	16	
3"	80	Rp 3	160	17	200	27	18	8	16	

Gcom-ctf-tonde-f-en\_a\_td

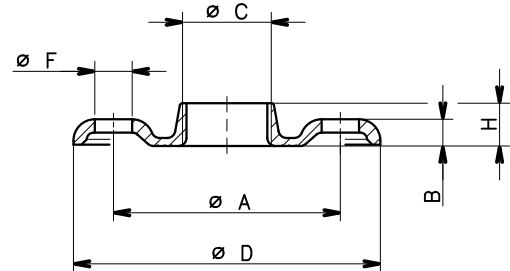

04430\_B\_DD

## WELD-ON COUNTERFLANGES

KIT TYPE	DN	ø C	DIMENSIONS (mm)				HOLES			PN
			ø A	B	ø D	ø F	N°			
2"	50	61	125	19	165	18	4	16		
2"1/2	65	77	145	20	185	18	4	16		
3"	80	90	160	20	200	18	8	16		
4"	100	116	180	22	220	18	8	16		
5"	125	141,5	210	22	250	18	8	16		
6"	150	170,5	240	24	285	22	8	16		
8"	200	221,5	295	26	340	22	12	16		
10"	250	276,5	355	29	405	26	12	16		
12"	300	327,5	410	32	460	26	12	16		

Gcom-ctf-tonde-s-en\_c\_td

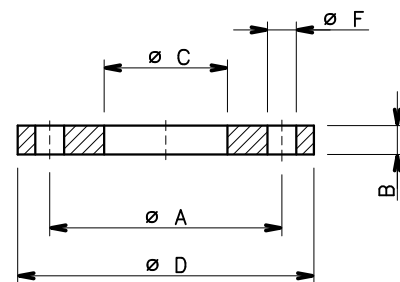





04431\_A\_DD

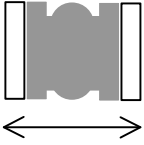

## ANTI-VIBRATION JOINT KIT

Anti-vibration joints, or compensation joints, can be used to absorb deformations, expansions, pipe noise and reduce water hammering. They can also withstand a high level of vacuum, which enables the absorption of negative expansions due to depression.

Due to its elasticity, the material can deform or expand as necessary, making installation easier, simpler and quicker, even when the piping is not aligned. It does not required assembly joints.

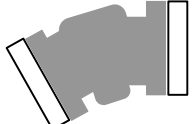
TABELLA 1 TABLE 1		L  mm	A-B-C-D non possono essere sommati			A-B-C-D can not be cumulative
GIUNTI ELASTICI RUBBER EXPANSION JOINT			A  COMPRESSIONE COMPRESSION mm	B  ESTENSIONE EXTENSION mm	C  SPOSTAMENTO TRANSVERSE mm	D  FLESSIONE ANGOLARE ANGULAR MOVEMENT (°)
32	1"1/4	95	8	4	8	15
40	1"1/2	95	8	4	8	15
50	2"	105	8	5	8	15
65	2"1/2	115	12	6	10	15
80	3"	130	12	6	10	15
100	4"	135	18	10	12	15
125	5"	170	18	10	12	15
150	6"	180	18	10	12	15
200	8"	205	25	14	22	15
250	10"	240	25	14	22	15
300	12"	260	25	14	22	15
350	14"	265	25	16	22	15
400	16"	265	25	16	22	15
450	18"	265	25	16	22	15
500	20"	265	25	16	22	15

GD\_JOINT\_A\_TD

## PROTECTION SYSTEMS AGAINST DRY RUNNING

To avoid damaging the pumps, protection systems must be used to prevent it from dry running.

### FLOAT SWITCH PROTECTION

The float switch system is used for supplies from open tanks. The float switch immersed in the tank must be connected to the control panel. If there is no water, the float switch opens the electrical contact and the pumps stop.

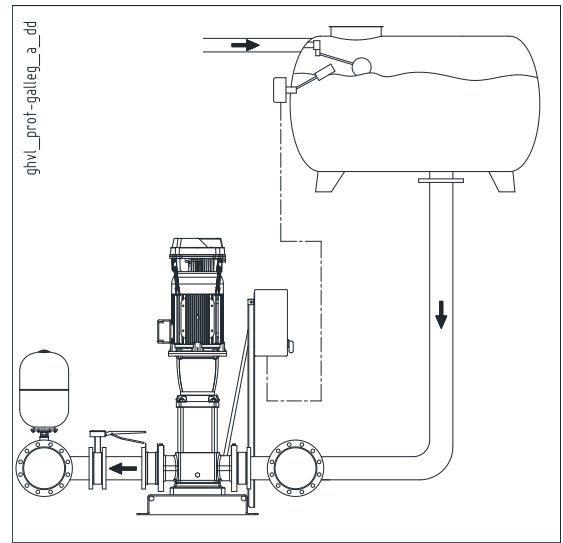

### ELECTRODE PROBE PROTECTION

The system with electrode probes is used for supplies from open tanks or wells.

Three probes are directly connected to the electric module with adjustable sensitivity that can be installed in the control panel. If there is no water, the control circuit opens the electrical contact and the pumps stop.

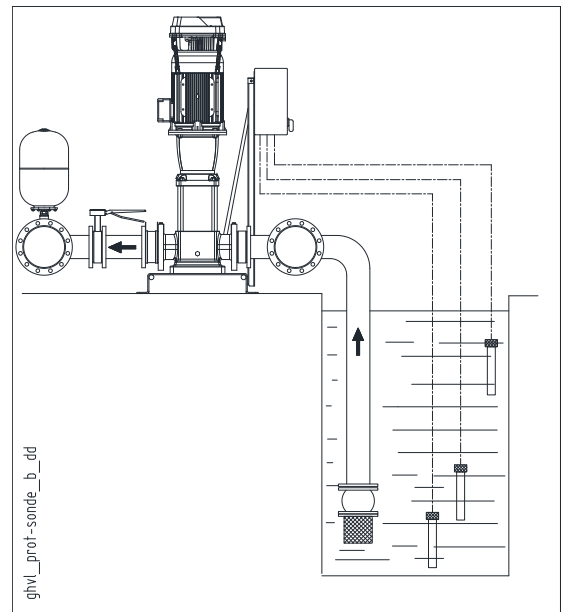

### MINIMUM PRESSURE SWITCH PROTECTION

The system with minimum pressure switch is used for water supplies from pressurised networks or tanks. The pressure switch is connected to the control panel. In case of water shortage, it opens the electric contact, causing the stop of the pumps.

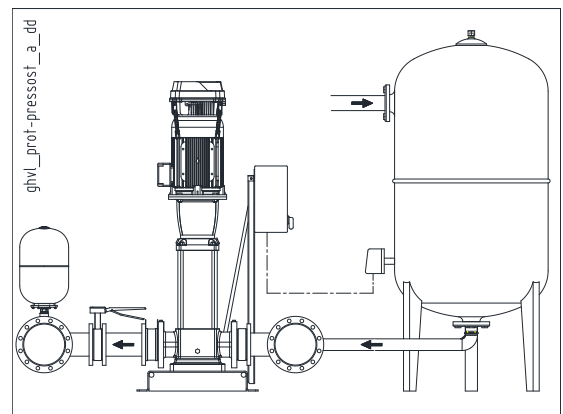

## PROTECTION SENSOR AGAINST DRY RUNNING



Sensor for detecting the presence of water based on the optoelectronic principle, therefore non-invasive and with no moving parts. The sensor features an electronic contact (on/off) which stops the pump if there is no water in the seal area. The sensor opens the electric contact if there is no water after they factory-set delay (10 seconds) elapses. The sensor is supplied as a kit complete with 2 metres of cable, an EPDM O-ring gasket and a stainless steel adapter.

### General operating features

- The sensor can be fitted directly on the filling cap of the e-SV™ series of pumps.
- Operation is independent of the hardness and conductivity of the water. The sensor cannot detect frozen liquids.

### Available in two power versions depending on foreseen use:

- 21 ÷ 27 Vac, universal solid state output for external relay at 24 Vac (21 ÷ 27 Vac, 50 mA).
- 15 ÷ 25 Vdc, NPN output at 25 V (10 mA) for HYDROVAR® inverter.

### Operating principle

Operation is based on the change in the refractive index on the surfaces. The optic sensor comprises a glass cap (C) containing a transmitter (T) and an infrared receiver (R).

If there is no liquid, all the infrared light emitted by the transmitter is internally reflected by the surface of the glass cap of the receiver. The electronic contact will be open.

If liquid is present, the refractive index of the surface changes. Most of the infrared light emitted by the transmitter is dispersed in the liquid. The receiver receives less light and the electronic contact is closed.

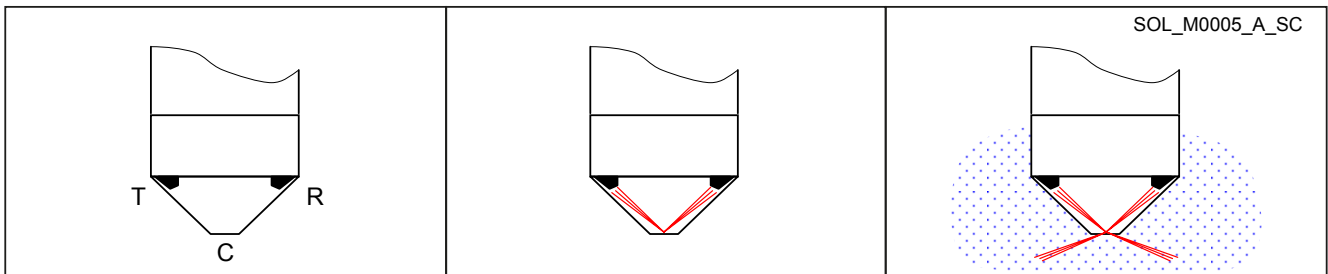

## SPECIFICATIONS

- Materials:
  - Body in AISI 316L stainless steel
  - Glass optic cap
  - EPDM gasket
- Liquids: clean water, demi water. Operation is not affected by the hardness and conductivity of the liquid. To check the suitability of other liquids, contact the Lowara technical assistance service providing the characteristics of the liquid.
- Temperature of liquid: -20°C ÷ +120°C (cannot be used to detect frozen liquids).
- Ambient temperature: -5°C ÷ +50°C
- Maximum pressure (PN): 25 bar
- Connector: 3/8" (3/8" x 1/2" adaptor plug included in the Kit)
- Dimensions: 27x 60 mm
- IP55 protection
- Electrical characteristics:
  - Input voltage SENSOR KIT DRP-GP: 21 ÷ 27 Vac  
SENSOR KIT DRP-HV: 15 ÷ 25 Vdc
  - Output SENSOR KIT DRP-GP: universal solid state 21 ÷ 27 Vac (50 mA) for 24 Vac external relay  
SENSOR KIT DRP-HV: NPN 25 V (10 mA) for HYDROVAR® inverter
  - Alarm delay: 10 seconds (factory setting)
  - FROR cable 4 x 0,34 mm<sup>2</sup> (PVC-CEI 20-22) 2 metres long.

**WIRING DIAGRAM**

The sensor can be directly mounted on the filling plug of the e-SV™ pumps.  
For the 33, 46, 66, 92, 125SV series, the 3/8" x 1/2" adaptor ring included in the Kit must also be mounted.

**KIT SENSOR DRP-GP (code 109394610)**



**KIT SENSOR DRP-HV (code 109394600)**

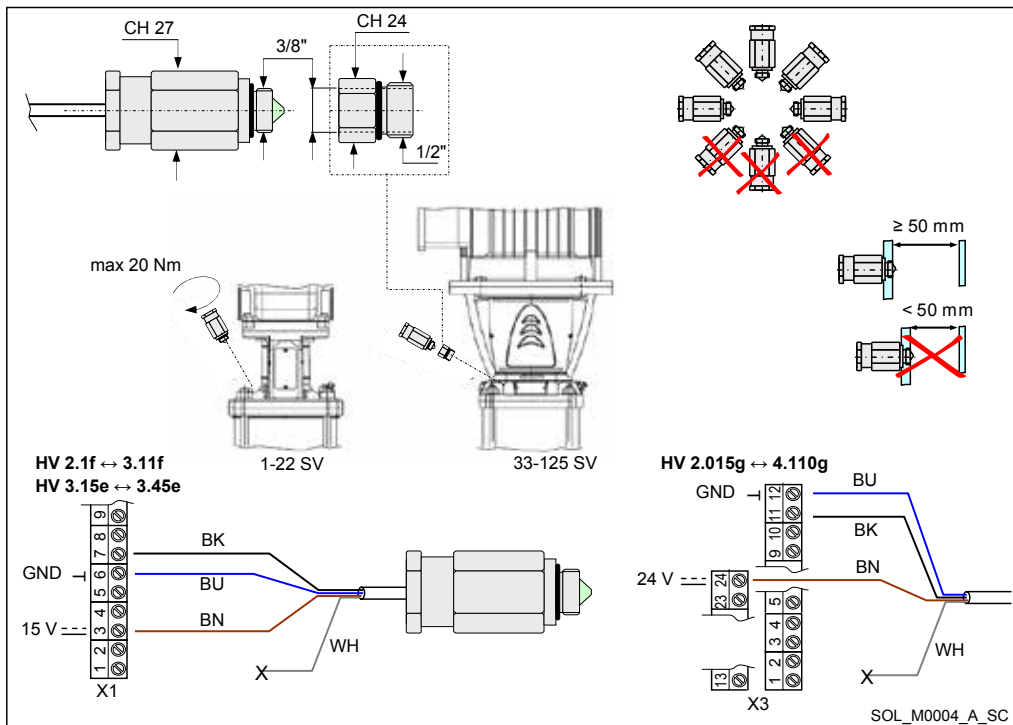

BK Black      BN Brown      BU Blue      WH White      X1, X3 Terminal board

**ACCESSORIES**

**ACCESSORIES/SPARE PARTS**



**HYDROTUBE**



**PRESSURE SWITCH**



**FLOAT SWITCHES**



**VALVES**



**OPTIC SENSORS**

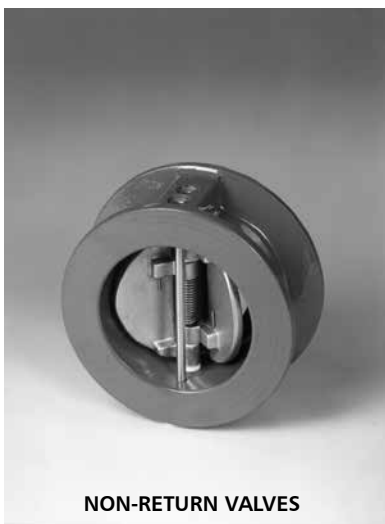

**NON-RETURN VALVES**



**JOINTS**



**PRESSURE SENSOR**



# TECHNICAL APPENDIX

**VAPOUR PRESSURE**

**VAPOUR PRESSURE  $p_s$  AND  $\rho$  DENSITY OF WATER TABLE**

t °C	T K	$p_s$ bar	$\rho$ kg/dm <sup>3</sup>	t °C	T K	$p_s$ bar	$\rho$ kg/dm <sup>3</sup>	t °C	T K	$p_s$ bar	$\rho$ kg/dm <sup>3</sup>
0	273,15	0,00611	0,9998	55	328,15	0,15741	0,9857	120	393,15	1,9854	0,9429
1	274,15	0,00657	0,9999	56	329,15	0,16511	0,9852	122	395,15	2,1145	0,9412
2	275,15	0,00706	0,9999	57	330,15	0,17313	0,9846	124	397,15	2,2504	0,9396
3	276,15	0,00758	0,9999	58	331,15	0,18147	0,9842	126	399,15	2,3933	0,9379
4	277,15	0,00813	1,0000	59	332,15	0,19016	0,9837	128	401,15	2,5435	0,9362
5	278,15	0,00872	1,0000	60	333,15	0,1992	0,9832	130	403,15	2,7013	0,9346
6	279,15	0,00935	1,0000	61	334,15	0,2086	0,9826	132	405,15	2,867	0,9328
7	280,15	0,01001	0,9999	62	335,15	0,2184	0,9821	134	407,15	3,041	0,9311
8	281,15	0,01072	0,9999	63	336,15	0,2286	0,9816	136	409,15	3,223	0,9294
9	282,15	0,01147	0,9998	64	337,15	0,2391	0,9811	138	411,15	3,414	0,9276
10	283,15	0,01227	0,9997	65	338,15	0,2501	0,9805	140	413,15	3,614	0,9258
11	284,15	0,01312	0,9997	66	339,15	0,2615	0,9799	145	418,15	4,155	0,9214
12	285,15	0,01401	0,9996	67	340,15	0,2733	0,9793	155	428,15	5,433	0,9121
13	286,15	0,01497	0,9994	68	341,15	0,2856	0,9788	160	433,15	6,181	0,9073
14	287,15	0,01597	0,9993	69	342,15	0,2984	0,9782	165	438,15	7,008	0,9024
15	288,15	0,01704	0,9992	70	343,15	0,3116	0,9777	170	443,15	7,920	0,8973
16	289,15	0,01817	0,9990	71	344,15	0,3253	0,9770	175	448,15	8,924	0,8921
17	290,15	0,01936	0,9988	72	345,15	0,3396	0,9765	180	453,15	10,027	0,8869
18	291,15	0,02062	0,9987	73	346,15	0,3543	0,9760	185	458,15	11,233	0,8815
19	292,15	0,02196	0,9985	74	347,15	0,3696	0,9753	190	463,15	12,551	0,8760
20	293,15	0,02337	0,9983	75	348,15	0,3855	0,9748	195	468,15	13,987	0,8704
21	294,15	0,24850	0,9981	76	349,15	0,4019	0,9741	200	473,15	15,550	0,8647
22	295,15	0,02642	0,9978	77	350,15	0,4189	0,9735	205	478,15	17,243	0,8588
23	296,15	0,02808	0,9976	78	351,15	0,4365	0,9729	210	483,15	19,077	0,8528
24	297,15	0,02982	0,9974	79	352,15	0,4547	0,9723	215	488,15	21,060	0,8467
25	298,15	0,03166	0,9971	80	353,15	0,4736	0,9716	220	493,15	23,198	0,8403
26	299,15	0,03360	0,9968	81	354,15	0,4931	0,9710	225	498,15	25,501	0,8339
27	300,15	0,03564	0,9966	82	355,15	0,5133	0,9704	230	503,15	27,976	0,8273
28	301,15	0,03778	0,9963	83	356,15	0,5342	0,9697	235	508,15	30,632	0,8205
29	302,15	0,04004	0,9960	84	357,15	0,5557	0,9691	240	513,15	33,478	0,8136
30	303,15	0,04241	0,9957	85	358,15	0,5780	0,9684	245	518,15	36,523	0,8065
31	304,15	0,04491	0,9954	86	359,15	0,6011	0,9678	250	523,15	39,776	0,7992
32	305,15	0,04753	0,9951	87	360,15	0,6249	0,9671	255	528,15	43,246	0,7916
33	306,15	0,05029	0,9947	88	361,15	0,6495	0,9665	260	533,15	46,943	0,7839
34	307,15	0,05318	0,9944	89	362,15	0,6749	0,9658	265	538,15	50,877	0,7759
35	308,15	0,05622	0,9940	90	363,15	0,7011	0,9652	270	543,15	55,058	0,7678
36	309,15	0,05940	0,9937	91	364,15	0,7281	0,9644	275	548,15	59,496	0,7593
37	310,15	0,06274	0,9933	92	365,15	0,7561	0,9638	280	553,15	64,202	0,7505
38	311,15	0,06624	0,9930	93	366,15	0,7849	0,9630	285	558,15	69,186	0,7415
39	312,15	0,06991	0,9927	94	367,15	0,8146	0,9624	290	563,15	74,461	0,7321
40	313,15	0,07375	0,9923	95	368,15	0,8453	0,9616	295	568,15	80,037	0,7223
41	314,15	0,07777	0,9919	96	369,15	0,8769	0,9610	300	573,15	85,927	0,7122
42	315,15	0,08198	0,9915	97	370,15	0,9094	0,9602	305	578,15	92,144	0,7017
43	316,15	0,09639	0,9911	98	371,15	0,9430	0,9596	310	583,15	98,70	0,6906
44	317,15	0,09100	0,9907	99	372,15	0,9776	0,9586	315	588,15	105,61	0,6791
45	318,15	0,09582	0,9902	100	373,15	1,0133	0,9581	320	593,15	112,89	0,6669
46	319,15	0,10086	0,9898	102	375,15	1,0878	0,9567	325	598,15	120,56	0,6541
47	320,15	0,10612	0,9894	104	377,15	1,1668	0,9552	330	603,15	128,63	0,6404
48	321,15	0,11162	0,9889	106	379,15	1,2504	0,9537	340	613,15	146,05	0,6102
49	322,15	0,11736	0,9884	108	381,15	1,3390	0,9522	350	623,15	165,35	0,5743
50	323,15	0,12335	0,9880	110	383,15	1,4327	0,9507	360	633,15	186,75	0,5275
51	324,15	0,12961	0,9876	112	385,15	1,5316	0,9491	370	643,15	210,54	0,4518
52	325,15	0,13613	0,9871	114	387,15	1,6362	0,9476	374,15	647,30	221,20	0,3154
53	326,15	0,14293	0,9862	116	389,15	1,7465	0,9460				
54	327,15	0,15002	0,9862	118	391,15	1,8628	0,9445				

G-at\_nps\_h\_sc



## TANK

### CHOOSING AND SIZING THE SURGE TANK

The purpose of the surge tank is to limit the number of hourly starts of the pumps, placing part of its stock of water, which is maintained under pressure by the air above it, at the disposal of the system.

The surge tank can be of the air cushion or diaphragm type.

In the air cushion version there is no clear separation between air and water.

Since part of the air tends to mix with water, it is necessary to restore it by means of air supply units or a compressor.

In the diaphragm version, neither air supply units nor compressor are needed, as contact between air and water is prevented by a flexible diaphragm inside the tank.

The following method, which is used to determine the volume of a surge tank, is valid both for horizontal and vertical surge tanks.

When calculating the volume of the surge tank, it is generally sufficient to consider the first pump only.

### DIAPHRAGM TANK

If you decide to use a diaphragm tank, the volume will be lower than that of the air-cushion tank. It can be calculated with the following formula:

$$V_m = \frac{Q_p}{4 \times Z} \times \frac{1}{1 - \frac{(P_{min} - 2)}{P_{max}}}$$

where:

$V_m$  = Total volume of the air-cushion surge tank in  $m^3$

$Q_p$  = Average pump flow rate in  $m^3/h$

$P_{max}$  = Maximum pressure setting (wcm)

$P_{min}$  = Minimum pressure setting (wcm)

$Z$  = Maximum number of starts per hour allowed by the motor

**Example:**

22SV10F110T electric pump

$P_{max}$  = 23 wcm

$P_{min}$  = 15 wcm

$Q_p$  = 20  $m^3/h$

$Z$  = 25

$$V_m = \frac{Q_p}{4 \times Z} \times \frac{1}{1 - \frac{(P_{min} - 2)}{P_{max}}} = 0,46 \text{ m}^3$$

A 500-litre surge tank is therefore required.

## PERFORMANCE WITH VARYING SPEED EQUIVALENCE RELATIONS

Fitting the electric pump with a frequency converter makes it possible to vary the pump rotation speed, normally according to the system pressure parameter. **Variations in electric pump speed** result in **modified performances** according to the equivalence relations.

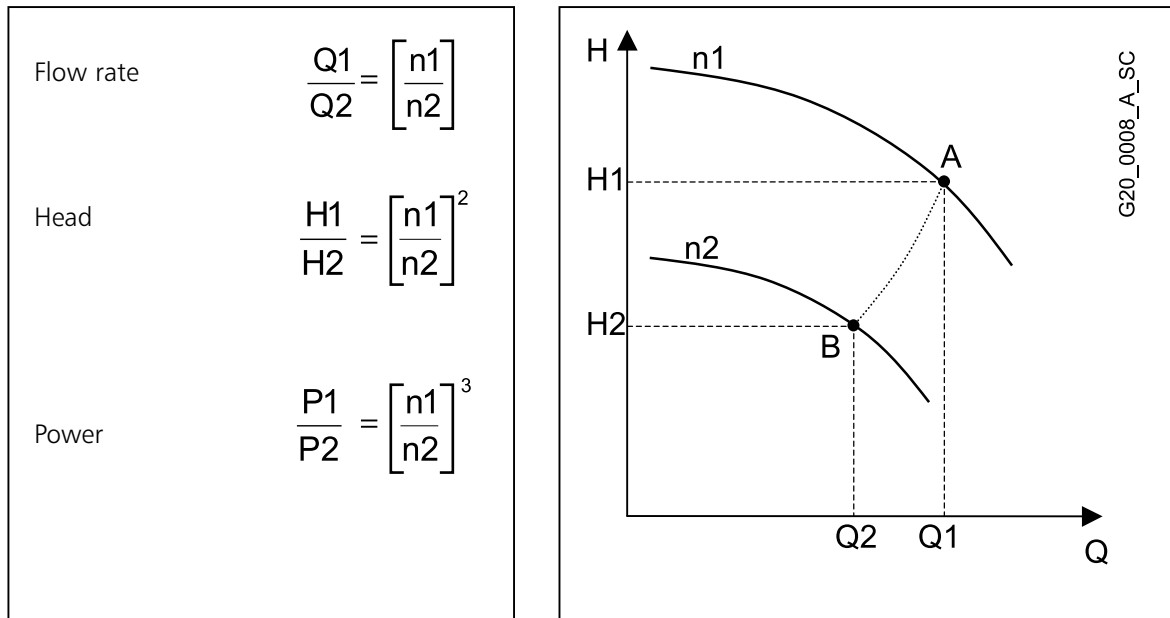

n1 = initial speed;                      n2 = speed required.  
 Q1 = initial flow rate;                Q2 = flow rate required.  
 H1 = initial head;                      H2 = head required.  
 P1 = initial power;                      P2 = power required

**Frequency ratios** can be used instead of speed in practical applications, keeping 30 Hz as the bottom limit.

**Example** : 2-pole 50 Hz electric pump n1 = 2900 (point A)  
 Flow rate (A) = 100 l/min; Head (A) = 50m  
 By reducing the frequency to 30 Hz the speed is reduced to approx. n2 = 1740 rpm (point B)  
 Flow rate (B) = 60 l/min; Head (B) = 18 m  
 The power of the new work point B is cut to about 22% of the initial power.

## -sizing the Diaphragm Tank in Systems with Speed Variation

**Variable speed** booster sets need **smaller tanks** compared to traditional systems. Generally speaking, a tank with a litre capacity of just 10% of the nominal capacity of a single pump, expressed in litres per minute, is needed. The **gradual starting** of the pumps controlled by the frequency converters reduces the need to limit the number of hourly starts; the main purpose of the tank is to compensate for small system losses, stabilize the pressure and make up for pressure variations caused by sudden demand.

Make the following calculation:  
 Set made up of three electric pumps, each with a maximum flow rate of 400 l/min, for a total capacity of 1200 l/min. The **volume** required for the tank is 40 litres. This size can be obtained by using two 24-litre tanks mounted directly onto the set's manifold.  
 The calculation establishes the minimum value needed for proper operation.

## TABLE OF FLOW RESISTANCE IN 100 m OF STRAIGHT CAST IRON PIPELINE (HAZEN-WILLIAMS FORMULA C=100)

FLOW RATE			NOMINAL DIAMETER in mm and inches																					
m <sup>3</sup> /h	l/min		15 1/2"	20 3/4"	25 1"	32 1 1/4"	40 1 1/2"	50 2	65 2 1/2"	80 3"	100 4"	125 5"	150 6"	175 7"	200 8"	250 10"	300 12"	350 14"	400 16"					
0,6	10	v hr	0,94 16	0,53 3,94	0,34 1,33	0,21 0,40	0,13 0,13																	
0,9	15	v hr	1,42 33,9	0,80 8,35	0,51 2,82	0,31 0,85	0,20 0,29																	
1,2	20	v hr	1,89 57,7	1,06 14,21	0,68 4,79	0,41 1,44	0,27 0,49	0,17 0,16																
1,5	25	v hr	2,36 87,2	1,33 21,5	0,85 7,24	0,52 2,18	0,33 0,73	0,21 0,25																
1,8	30	v hr	2,83 122	1,59 30,1	1,02 10,1	0,62 3,05	0,40 1,03	0,25 0,35																
2,1	35	v hr	3,30 162	1,86 40,0	1,19 13,5	0,73 4,06	0,46 1,37	0,30 0,46																
2,4	40	v hr		2,12 51,2	1,36 17,3	0,83 5,19	0,53 1,75	0,34 0,59	0,20 0,16															
3	50	v hr		2,65 77,4	1,70 26,1	1,04 7,85	0,66 2,65	0,42 0,89	0,25 0,25															
3,6	60	v hr		3,18 108	2,04 36,6	1,24 11,0	0,80 3,71	0,51 1,25	0,30 0,35															
4,2	70	v hr		3,72 144	2,38 48,7	1,45 14,6	0,93 4,93	0,59 1,66	0,35 0,46															
4,8	80	v hr		4,25 185	2,72 62,3	1,66 18,7	1,06 6,32	0,68 2,13	0,40 0,59															
5,4	90	v hr		3,06 77,5	1,87 23,3	1,19 7,85	0,76 2,65	0,45 0,74	0,30 0,27															
6	100	v hr			3,40 94,1	2,07 28,3	1,33 9,54	0,85 3,22	0,50 0,90	0,33 0,33														
7,5	125	v hr			4,25 142	2,59 42,8	1,66 14,4	1,06 4,86	0,63 1,36	0,41 0,49														
9	150	v hr				3,11 59,9	1,99 20,2	1,27 6,82	0,75 1,90	0,50 0,69	0,32 0,23													
10,5	175	v hr				3,63 79,7	2,32 26,9	1,49 9,07	0,88 2,53	0,58 0,92	0,37 0,31													
12	200	v hr				4,15 102	2,65 34,4	1,70 11,6	1,01 3,23	0,66 1,18	0,42 0,40													
15	250	v hr				5,18 154	3,32 52,0	2,12 17,5	1,26 4,89	0,83 1,78	0,53 0,60	0,34 0,20												
18	300	v hr				3,98 72,8	2,55 24,6	1,51 6,85	1,00 2,49	0,64 0,84	0,41 0,28													
24	400	v hr				5,31 124	3,40 41,8	2,01 11,66	1,33 4,24	0,85 1,43	0,54 0,48	0,38 0,20												
30	500	v hr				6,63 187	4,25 63,2	2,51 17,6	1,66 6,41	1,06 2,16	0,68 0,73	0,47 0,30												
36	600	v hr					5,10 88,6	3,02 24,7	1,99 8,98	1,27 3,03	0,82 1,02	0,57 0,42	0,42 0,20											
42	700	v hr					5,94 118	3,52 32,8	2,32 11,9	1,49 4,03	0,95 1,36	0,66 0,56	0,49 0,26											
48	800	v hr					6,79 151	4,02 42,0	2,65 15,3	1,70 5,16	1,09 1,74	0,75 0,72	0,55 0,34											
54	900	v hr					7,64 188	4,52 52,3	2,99 19,0	1,91 6,41	1,22 2,16	0,85 0,89	0,62 0,42											
60	1000	v hr						5,03 63,5	3,32 23,1	2,12 7,79	1,36 2,63	0,94 1,08	0,69 0,51	0,53 0,27										
75	1250	v hr						6,28 96,0	4,15 34,9	2,65 11,8	1,70 3,97	1,18 1,63	0,87 0,77	0,66 0,40										
90	1500	v hr						7,54 134	4,98 48,9	3,18 16,5	2,04 5,57	1,42 2,29	1,04 1,08	0,80 0,56										
105	1750	v hr						8,79 179	5,81 65,1	3,72 21,9	2,38 7,40	1,65 3,05	1,21 1,44	0,93 0,75										
120	2000	v hr							6,63 83,3	4,25 28,1	2,72 9,48	1,89 3,90	1,39 1,84	1,06 0,96	0,68 0,32									
150	2500	v hr								8,29 126	5,31 42,5	3,40 14,3	2,36 5,89	1,73 2,78	1,33 1,45	0,85 0,49								
180	3000	v hr									6,37 59,5	4,08 20,1	2,83 8,26	2,08 3,90	1,59 2,03	1,02 0,69	0,71 0,28							
210	3500	v hr										7,43 79,1	4,76 26,7	3,30 11,0	2,43 5,18	1,86 2,71	1,19 0,91	0,83 0,38						
240	4000	v hr											8,49 101	5,44 34,2	3,77 14,1	2,77 6,64	2,12 3,46	1,36 1,17	0,94 0,48					
300	5000	v hr												6,79 51,6	4,72 21,2	3,47 10,0	2,65 5,23	1,70 1,77	1,18 0,73					
360	6000	v hr													8,15 72,3	5,66 29,8	4,16 14,1	3,18 7,33	2,04 2,47	1,42 1,02				
420	7000	v hr														6,61 39,6	4,85 18,7	3,72 9,75	2,38 3,29	1,65 1,35	1,21 0,64			
480	8000	v hr															7,55 23,9	5,55 12,49	4,25 4,21	2,72 1,73	1,89 0,82			
540	9000	v hr																8,49 29,8	6,24 15,5	4,78 5,24	3,06 2,16	2,12 1,56	1,56 0,53	
600	10000	v hr																	6,93 36,2	5,31 18,9	3,40 6,36	2,36 2,62	1,73 1,24	1,33 0,65

hr = flow resistance for 100 m of straight pipeline (m)

V = water speed (m/s)

G-at-pct-en\_b\_th

## FLOW RESISTANCE TABLE OF FLOW RESISTANCE IN BENDS, VALVES AND GATES

The flow resistance is calculated using the equivalent pipeline length method according to the table below:

ACCESSORY TYPE	DN											
	25	32	40	50	65	80	100	125	150	200	250	300
	Equivalent pipeline length (m)											
45° bend	0,2	0,2	0,4	0,4	0,6	0,6	0,9	1,1	1,5	1,9	2,4	2,8
90° bend	0,4	0,6	0,9	1,1	1,3	1,5	2,1	2,6	3,0	3,9	4,7	5,8
90° smooth bend	0,4	0,4	0,4	0,6	0,9	1,1	1,3	1,7	1,9	2,8	3,4	3,9
Union tee or cross	1,1	1,3	1,7	2,1	2,6	3,2	4,3	5,3	6,4	7,5	10,7	12,8
Gate valve	-	-	-	0,2	0,2	0,2	0,4	0,4	0,6	0,9	1,1	1,3
Foot check valve	1,1	1,5	1,9	2,4	3,0	3,4	4,7	5,9	7,4	9,6	11,8	13,9
Non return valve	1,1	1,5	1,9	2,4	3,0	3,4	4,7	5,9	7,4	9,6	11,8	13,9

G-a-pcv-en\_b\_th

The table is valid for the Hazen Williams coefficient  $C=100$  (cast iron pipework)  
 for galvanized steel or painted steel multiply the values by 0,71;  
 for stainless steel and copper multiply the values by 0,54;  
 for Pvc and PE multiply the values by 0,47.

When the **equivalent pipeline length** has been determined, the flow resistance is obtained from the table in the previous page.

The values given are guideline values which are bound to vary slightly according to the model, especially for gate valves and non-return valves, for which it is a good idea to check the values supplied by manufacturers.

## VOLUMETRIC CAPACITY

Litres per minute l/min	Cubic metres per hour m <sup>3</sup> /h	Cubic feet per hour ft <sup>3</sup> /h	Cubic feet per minute ft <sup>3</sup> /min	Imperial gallon per minute Imp. gal/min	U.S. gallon per minute US gal/min
<b>1,000</b>	0,0600	2,1189	0,0353	0,2200	0,2642
16,6667	<b>1,0000</b>	35,3147	0,5886	3,6662	4,4029
0,4719	0,0283	<b>1,0000</b>	0,0167	0,1038	0,1247
28,3168	1,6990	60,0000	<b>1,0000</b>	6,2288	7,4805
4,5461	0,2728	9,6326	0,1605	<b>1,0000</b>	1,2009
3,7854	0,2271	8,0208	0,1337	0,8327	<b>1,0000</b>

## PRESSURE AND HEAD

Newton per square metre N/m <sup>2</sup>	kilo Pascal kPa	bar bar	Pound force per square inch psi	Metre of water m H <sub>2</sub> O	Millimetre of mercury mm Hg
<b>1,0000</b>	0,0010	1 x 10 <sup>-5</sup>	1,45 x 10 <sup>-4</sup>	1,02 x 10 <sup>-4</sup>	0,0075
1 000,0000	<b>1,0000</b>	0,0100	0,1450	0,1020	7,5006
1 x 10 <sup>5</sup>	100,0000	<b>1,0000</b>	14,5038	10,1972	750,0638
6 894,7570	6,8948	0,0689	<b>1,0000</b>	0,7031	51,7151
9 806,6500	9,8067	0,0981	1,4223	<b>1,0000</b>	73,5561
133,3220	0,1333	0,0013	0,0193	0,0136	<b>1,0000</b>

## LENGTH

Millimetre mm	Centimetre cm	Metre m	Inch in	Foot ft	Yard yd
<b>1,0000</b>	0,1000	0,0010	0,0394	0,0033	0,0011
10,0000	<b>1,0000</b>	0,0100	0,3937	0,0328	0,0109
1 000,0000	100,0000	<b>1,0000</b>	39,3701	3,2808	1,0936
25,4000	2,5400	0,0254	<b>1,0000</b>	0,0833	0,0278
304,8000	30,4800	0,3048	12,0000	<b>1,0000</b>	0,3333
914,4000	91,4400	0,9144	36,0000	3,0000	<b>1,0000</b>

## VOLUME

Cubic metre m <sup>3</sup>	Litre L	Millilitre ml	Imperial gallon imp. gal.	U.S. gallon US gal.	Cubic foot ft <sup>3</sup>
<b>1,0000</b>	1 000,0000	1 x 10 <sup>6</sup>	219,9694	264,1720	35,3147
0,0010	<b>1,0000</b>	1 000,0000	0,2200	0,2642	0,0353
1 x 10 <sup>-6</sup>	0,0010	<b>1,0000</b>	2,2 x 10 <sup>-4</sup>	2,642 x 10 <sup>-4</sup>	3,53 x 10 <sup>-5</sup>
0,0045	4,5461	4 546,0870	<b>1,0000</b>	1,2009	0,1605
0,0038	3,7854	3 785,4120	0,8327	<b>1,0000</b>	0,1337
0,0283	28,3168	28 316,8466	6,2288	7,4805	<b>1,0000</b>

## TEMPERATURE

Water	Kelvin K	Celsius °C	Fahrenheit °F	$^{\circ}\text{F} = ^{\circ}\text{C} \times \frac{9}{5} + 32$ $^{\circ}\text{C} = (^{\circ}\text{F} - 32) \times \frac{5}{9}$
icing	273,1500	0,0000	32,0000	
boiling	373,1500	100,0000	212,0000	

G-at\_pp-en\_b\_sc

**FURTHER PRODUCT SELECTION  
AND DOCUMENTATION**  
**Xylect™**

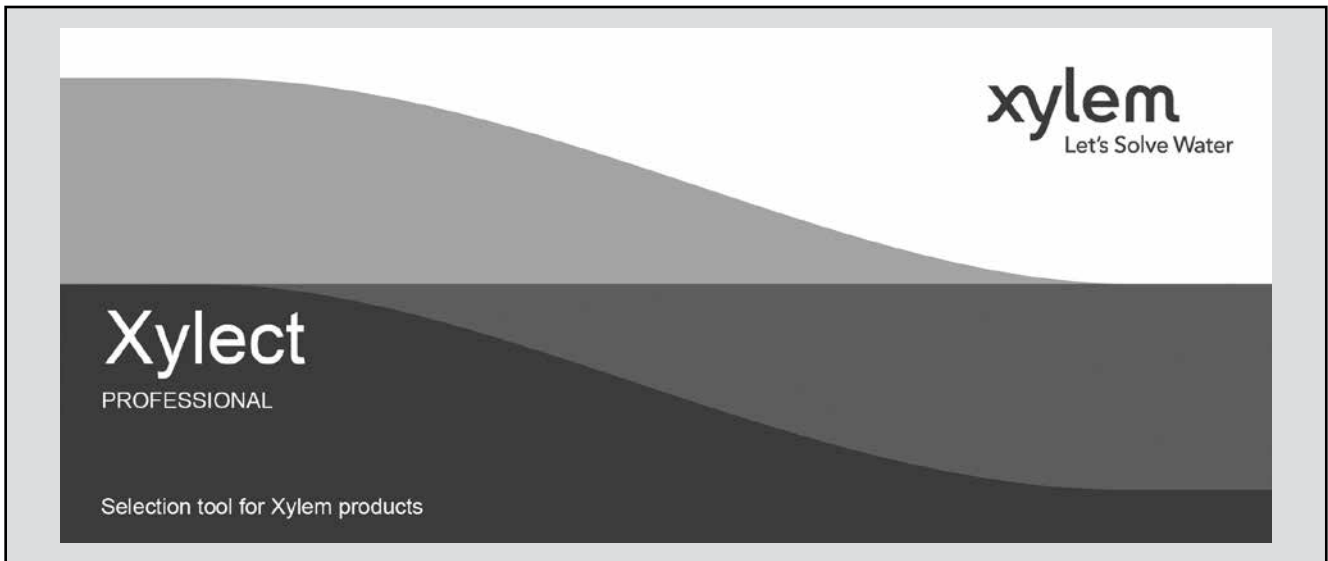

Xylect™ is pump solution selection software with an extensive online database of product information across the entire Lowara range of pumps and related products, with multiple search options and helpful project management facilities. The system holds up-to-date product information on thousands of products and accessories.

The possibility to search by applications and the detailed information output given makes it easy to make the optimal selection without having detailed knowledge about the Lowara products.

The search can be made by:

- Application
- Product type
- Duty point

Xylect™ gives a detailed output:

- List with search results
- Performance curves (flow, head, power, efficiency, NPSH)
- Motor data
- Dimensional drawings
- Options
- Data sheet printouts
- Document downloads incl dxf files

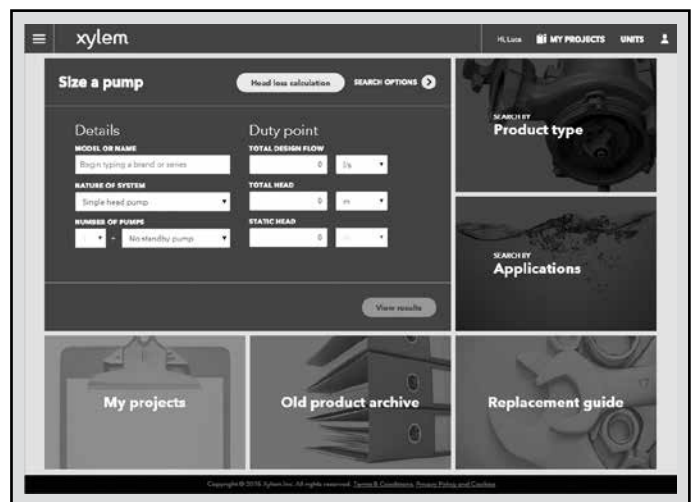

*The search by application guides users not familiar with the product range to the right choice.*

## FURTHER PRODUCT SELECTION AND DOCUMENTATION

### Xylect™



The detailed output makes it easy to select the optimal pump from the given alternatives.

The best way to work with Xylect™ is to create a personal account. This makes it possible to:

- Set own standard units
- Create and save projects
- Share projects with other Xylect™ users

Every user has a My Xylect space, where all projects are saved.

For more information about Xylect™ please contact our sales network or visit [www.xylect.com](http://www.xylect.com).

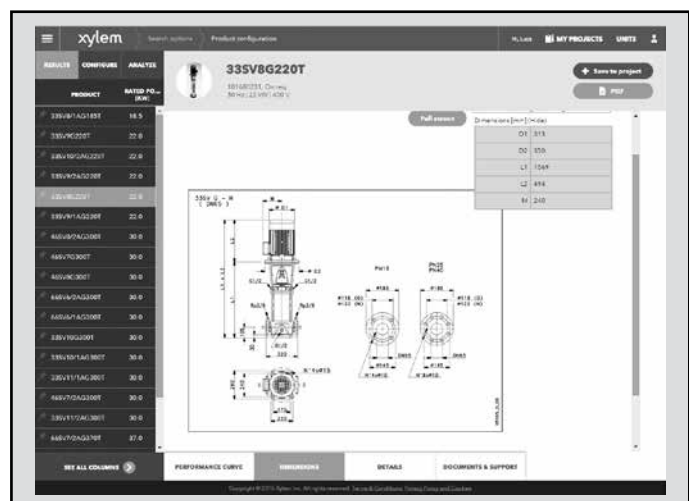

Dimensional drawings appear on the screen and can be downloaded in dxf format.











# Xylem |'zīləm|

- 1) The tissue in plants that brings water upward from the roots;
- 2) a leading global water technology company.

We're a global team unified in a common purpose: creating advanced technology solutions to the world's water challenges. Developing new technologies that will improve the way water is used, conserved, and reused in the future is central to our work. Our products and services move, treat, analyze, monitor and return water to the environment, in public utility, industrial, residential and commercial building services, and agricultural settings. With its October 2016 acquisition of Sensus, Xylem added smart metering, network technologies and advanced data analytics for water, gas and electric utilities to its portfolio of solutions. In more than 150 countries, we have strong, long-standing relationships with customers who know us for our powerful combination of leading product brands and applications expertise with a strong focus on developing comprehensive, sustainable solutions.

**For more information on how Xylem can help you, go to [xylem.com](http://xylem.com).**



For information and technical support  
Xylem Service Italia Srl

Via Dottor Vittorio Lombardi 14  
36075 - Montecchio Maggiore (VI) - Italy  
Tel. (+39) 0444 707111  
Fax (+39) 0444 491043  
[www.lowara.com](http://www.lowara.com)

Xylem Service Italia Srl reserves the right to make modification without prior notice.  
Lowara, Xylem are trademarks of Xylem Inc. or one of its subsidiaries  
© 2017 Xylem, Inc.